

## **ADAM-4571/4570**

**1/2-port RS-232/422/485  
Serial Device Servers**

## **ADAM-4571L/4570L**

**1/2-port RS-232  
Serial Device Servers**

**User Manual**

## **Copyright**

The documentation and the software included with this product are copyrighted 2010 by Advantech Co., Ltd. All rights are reserved. Advantech Co., Ltd. reserves the right to make improvements in the products described in this manual at any time without notice. No part of this manual may be reproduced, copied, translated or transmitted in any form or by any means without the prior written permission of Advantech Co., Ltd. Information provided in this manual is intended to be accurate and reliable. However, Advantech Co., Ltd. assumes no responsibility for its use, nor for any infringements of the rights of third parties, which may result from its use.

## **Acknowledgements**

Intel and Pentium are trademarks of Intel Corporation.

Microsoft Windows and MS-DOS are registered trademarks of Microsoft Corp.

All other product names or trademarks are properties of their respective owners.

Part No. 2003457102

3rd Edition

Printed in Taiwan

April 2010

## **Product Warranty (2 years)**

Advantech warrants to you, the original purchaser, that each of its products will be free from defects in materials and workmanship for two years from the date of purchase.

This warranty does not apply to any products which have been repaired or altered by persons other than repair personnel authorized by Advantech, or which have been subject to misuse, abuse, accident or improper installation. Advantech assumes no liability under the terms of this warranty as a consequence of such events.

Because of Advantech's high quality-control standards and rigorous testing, most of our customers never need to use our repair service. If an Advantech product is defective, it will be repaired or replaced at no charge during the warranty period. For out-of-warranty repairs, you will be billed according to the cost of replacement materials, service time and freight. Please consult your dealer for more details.

If you think you have a defective product, follow these steps:

1. Collect all the information about the problem encountered. (For example, CPU speed, Advantech products used, other hardware and software used, etc.) Note anything abnormal and list any onscreen messages you get when the problem occurs.
2. Call your dealer and describe the problem. Please have your manual, product, and any helpful information readily available.
3. If your product is diagnosed as defective, obtain an RMA (return merchandise authorization) number from your dealer. This allows us to process your return more quickly.
4. Carefully pack the defective product, a fully-completed Repair and Replacement Order Card and a photocopy proof of purchase date (such as your sales receipt) in a shippable container. A product returned without proof of the purchase date is not eligible for warranty service.
5. Write the RMA number visibly on the outside of the package and ship it prepaid to your dealer.

## **Declaration of Conformity**

### **CE**

This product has passed the CE test for environmental specifications when shielded cables are used for external wiring. We recommend the use of shielded cables. This kind of cable is available from Advantech. Please contact your local supplier for ordering information.

### **FCC Class A**

Note: This equipment has been tested and found to comply with the limits for a Class A digital device, pursuant to part 15 of the FCC Rules. These limits are designed to provide reasonable protection against harmful interference when the equipment is operated in a commercial environment. This equipment generates, uses, and can radiate radio frequency energy and, if not installed and used in accordance with the instruction manual, may cause harmful interference to radio communications. Operation of this equipment in a residential area is likely to cause harmful interference in which case the user will be required to correct the interference at his own expense.

## **Technical Support and Assistance**

Step 1. Visit the Advantech web site at **[www.advantech.com/support](http://www.advantech.com/support)** where you can find the latest information about the product.

Step 2. Contact your distributor, sales representative, or Advantech's customer service center for technical support if you need additional assistance. Please have the following information ready before you call:

- Product name and serial number
- Description of your peripheral attachments
- Description of your software (operating system, version, application software, etc.)
- A complete description of the problem
- The exact wording of any error messages

## **Safety Instructions**

1. Read these safety instructions carefully.
2. Keep this User's Manual for later reference.
3. Disconnect this equipment from any AC outlet before cleaning. Use a damp cloth. Do not use liquid or spray detergents for cleaning.
4. For plug-in equipment, the power outlet socket must be located near the equipment and must be easily accessible.
5. Keep this equipment away from humidity.
6. Put this equipment on a reliable surface during installation. Dropping it or letting it fall may cause damage.
7. The openings on the enclosure are for air convection. Protect the equipment from overheating. **DO NOT COVER THE OPENINGS.**
8. Make sure the voltage of the power source is correct before connecting the equipment to the power outlet.
9. Position the power cord so that people cannot step on it. Do not place anything over the power cord.
10. All cautions and warnings on the equipment should be noted.
11. If the equipment is not used for a long time, disconnect it from the power source to avoid damage by transient overvoltage.
12. Never pour any liquid into an opening. This may cause fire or electrical shock.
13. Never open the equipment. For safety reasons, the equipment should be opened only by qualified service personnel.
14. If one of the following situations arises, get the equipment checked by service personnel:
  - a. The power cord or plug is damaged.
  - b. Liquid has penetrated into the equipment.
  - c. The equipment has been exposed to moisture.
  - d. The equipment does not work well, or you cannot get it to work according to the user's manual.
  - e. The equipment has been dropped and damaged.
  - f. The equipment has obvious signs of breakage.
15. **DO NOT LEAVE THIS EQUIPMENT IN AN ENVIRONMENT WHERE THE STORAGE TEMPERATURE MAY GO BELOW -**

20° C (-4° F) OR ABOVE 60° C (140° F). THIS COULD DAMAGE THE EQUIPMENT. THE EQUIPMENT SHOULD BE IN A CONTROLLED ENVIRONMENT.

16. CAUTION: DANGER OF EXPLOSION IF BATTERY IS INCORRECTLY REPLACED. REPLACE ONLY WITH THE SAME OR EQUIVALENT TYPE RECOMMENDED BY THE MANUFACTURER, DISCARD USED BATTERIES ACCORDING TO THE MANUFACTURER'S INSTRUCTIONS.

The sound pressure level at the operator's position according to IEC 704-1:1982 is no more than 70 dB (A).

DISCLAIMER: This set of instructions is given according to IEC 704-1. Advantech disclaims all responsibility for the accuracy of any statements contained herein.

### **Safety Precaution - Static Electricity**

Follow these simple precautions to protect yourself from harm and the products from damage.

1. To avoid electrical shock, always disconnect the power from your PC chassis before you work on it. Don't touch any components on the CPU card or other cards while the PC is on.
2. Disconnect power before making any configuration changes. The sudden rush of power as you connect a jumper or install a card may damage sensitive electronic components.

# Contents

<b>Chapter 1</b>	<b>Overview .....</b>	<b>2</b>
1.1	Introduction .....	2
1.2	Features .....	2
1.3	Specifications .....	3
1.4	Package Checklist .....	5
1.4.1	ADAM-4571/4571L .....	5
1.4.2	ADAM-4570/4570L .....	5
<b>Chapter 2</b>	<b>Getting Started .....</b>	<b>8</b>
2.1	Understanding the Advantech ADAM-4570 Series.....	8
2.1.1	Network Architecture .....	8
2.1.2	LED Indicators .....	9
	Table 2.1:ADAM-4570 Series LED Definition .....	9
2.1.3	Dimensions (Unit: mm) .....	10
	Figure 2.1:Top Panel .....	10
	Figure 2.2:Front Panel .....	10
	Figure 2.3:Back Panel .....	10
2.1.4	Stickers .....	11
2.2	Connecting the Hardware.....	11
2.2.1	Choosing a Location .....	11
	Figure 2.4:Panel Mounting .....	12
	Figure 2.5:DIN-rail Mounting .....	13
	Figure 2.6:Piggyback Stack .....	14
2.2.2	Network Connection .....	15
	Figure 2.7:Connecting ADAM-4570 Series to a Hub ..	15
2.2.3	Power Connection .....	16
	Figure 2.8:Power Connection .....	16
2.2.4	Serial Connection .....	16
	Figure 2.9:Serial Connection .....	16
2.3	Configuration Utility Installation.....	18
<b>Chapter 3</b>	<b>Configuration.....</b>	<b>22</b>
3.1	Serial Device Server Configuration Utility Overview ....	22
3.2	Discovering Your Serial Device Server.....	24
3.2.1	Auto Searching .....	24
3.2.2	Clearing the Device List and Searching Again .....	27
3.2.3	Manual Appending .....	28
3.3	Setting Ethernet Parameters .....	29
3.4	Setting Serial Parameters .....	31
3.4.1	Basic Configuration .....	32
3.4.2	Operation Mode Configuration .....	34
3.4.3	Data Mode (USDG Mode) .....	36
3.4.4	Control Mode (USDG Mode) .....	40
3.4.5	AT Command List .....	42

	3.4.6	Advanced Settings .....	43
3.5		Security Configuration .....	44
	3.5.1	Accessible Function .....	44
	3.5.2	Port Monitor .....	45
3.6		Fulfilling Administrator Functions.....	46
	3.6.1	Import/Export Serial Port Setting .....	46
	3.6.2	Locate Serial Device .....	47
	3.6.3	Lock Device .....	47
	3.6.4	Restore to Factory Default Settings .....	48
	3.6.5	Upgrading the Firmware .....	49
<b>Chapter</b>	<b>4</b>	<b>Setting the COM Redirector .....</b>	<b>52</b>
	4.1	Setting COM Redirector (Virtual COM port).....	52
		4.1.1 Auto Mapping .....	52
		4.1.2 Manual Mapping .....	54
		4.1.3 Manual Direct Mapping Virtual COM Port .....	55
		4.1.4 Remove the Virtual COM Port .....	56
	4.2	Running Diagnostic Test.....	57
<b>Appendix</b>	<b>A</b>	<b>Pin Assignments .....</b>	<b>62</b>
	A.1	RS-232 Pin Assignments.....	62
	A.2	RJ-48 Cable PIN Assignment .....	62
		A.2.1 1. RS-422 .....	62
		A.2.2 2. RS-485 .....	62
<b>Appendix</b>	<b>B</b>	<b>Creating VCOM .....</b>	<b>64</b>
	B.1	Configuration Wizard.....	64



## Overview

# Chapter 1 Overview

## 1.1 Introduction

---

Advantech's ADAM-4570 series of Industrial Serial Device Servers are a robust, feature-rich, and cost effective way to network-enable equipment in an industrial automation environment. ADAM-4570 series provide one or two RS-232/422/485 serial ports, and ADAM-4571L/4570L provide one or two RS-232 serial ports.

By encapsulating serial data and transporting it over Ethernet, the ADAM-4570 series allows virtual serial links over Ethernet and IP (TCP/IP, UDP/IP) networks. After Advantech Serial Device Server Configuration Utility installation, standard serial operation calls are transparently redirected to the serial device servers, guaranteeing compatibility with legacy serial devices and enabling backward compatibility with existing software.

## 1.2 Features

---

- Up to 255 serial ports for one 2000/XP/Vista host
- Supports 10/100 Mbps auto-sensing Ethernet port
- Supports high transmission speeds up to 921.6 Kbps
- Supports LED indicators: Easy to diagnostic
- Supports integrated configuration utility and port-mapping utility: easy to configure and manage 255 COM ports and self-diagnostic
- Easy to locate specific ADAM-4570 Device Servers
- Supports multi-access features: allows max. of 5 hosts to access one serial port simultaneously
- Surge protection for power line
- Mounts on DIN-rail, panel or piggyback easily

## 1.3 Specifications

---

### LAN

- Compatibility: IEEE 802.3, IEEE 802.3u
- Speed: 10/100 Mbps, auto-sensing
- No. of Ports: 1
- Port Connector: 8-pin RJ45
- Protection: Built-in 1.5 KV magnetic isolation

### Serial Communications

- Port Type: ADAM-4570 series: RS-232/422/485  
ADAM-4571L/4570L: RS-232
- No. of Ports: ADAM-4571/4571L: 1  
ADAM-4570/4570L: 2
- Port Connector: ADAM-4571/4571L: DB9 male  
ADAM-4570/4570L: 10-pin RJ48
- Data Bits: 5, 6, 7, 8
- Stop Bits: 1, 1.5, 2
- Parity Bits: None, Odd, Even, Space, Mark
- Flow Control: XON/XOFF, RTS/CTS, DTR/DSR
- Baud Rate: 50 bps to 921.6 Kbps
- Serial Signals: RS-232: TxD, RxD, CTS, RTS, DTR, DSR, DCD, RI, GND  
RS-422: TxD+, TxD-, RxD+, RxD-, GND  
RS-485: Data+, Data-, GND
- Protection: 15 KV ESD protection for all signals

## Software

- Driver Support: Windows 2000/XP/Vista
- Utility Software: Serial Device Server Configuration Utility
- Operation Modes: COM port redirection mode (Virtual COM)
  - TCP/UDP server mode
  - TCP/UDP client mode
  - Pair connection (peer to peer) mode
- Configuration Methods: Windows utility, Web Browser, and Telnet

## Mechanics

- Dimensions (H x W x D): 130 x 70 x 30 mm
- Enclosure: ABS + PC with solid mounting hardware
- Mounting: DIN-rail, panel mount, piggyback stack
- Weight: ADAM-4571/4571L: 135g  
ADAM-4570/4570L: 160g

## General

- LED Indicators: Power, System Status
- LAN: Speed, Link/Active
- Serial: Tx, Rx

## Power Requirement

- Power Input: 10 to 30 V<sub>DC</sub>
- Power Consumption: ADAM-4571/4571L: 1.5W  
ADAM-4570/4570L: 2W
- Power Line Protection: 1 KV burst (EN61000-4-4),  
0.5 KV surge (EN61000-4-5)

## Environment

- Operating Temperature: 0 to 60° C (32 to 140° F)
- Storage Temperature: 20 to 80° C (-4 to 176° F)
- Operating Humidity: 5 to 95 % RH

## Regulatory Approvals

- EMC: CE, FCC Part 15 Subpart B (Class A)

## 1.4 Package Checklist

---

### 1.4.1 ADAM-4571/4571L

- 1 x ADAM-4571/4571L Serial Device Server
- CD-ROM for utility and manual
- 1 x RS-232 loopback DB9 tester
- Five stickers
- DIN-rail mounting Adapter
- Panel mounting bracket
- Stand

### 1.4.2 ADAM-4570/4570L

- 1 x ADAM-4570/4570L Serial Device Server
- CD-ROM for utility and manual
- 1 x RS-232 loopback DB9 tester
- 2 x RJ48 to DB9 serial cable
- Five stickers
- DIN-rail mounting Adapter
- Panel mounting bracket
- Stand



CHAPTER  
**2**

**Getting Started**

# Chapter 2 Getting Started

In this chapter, you will be given an overview of the ADAM-4570 series hardware installation procedures.

## **2.1 Understanding the Advantech ADAM-4570 Series**

---

The ADAM-4570 series are advanced device servers. They extend traditional COM ports of a PC with access over a TCP/IP network. Through networking, you can control and monitor remote serial devices either over a LAN or over the WAN. Since the ADAM-4570 series is connected through a TCP/IP network, you will need to know some basic facts about networking in order to get the server hooked up correctly.

### **2.1.1 Network Architecture**

Traditional serial port communication uses a COM port board that slides into one of the slots at the back of your PC. In this case, only the computer containing the board can access the serial port. With the ADAM-4570 series, you are now able to access the COM port from a distance through local area network. The ADAM-4570 series can be integrated within the network architecture of any protocol. Note, all serial devices which are connected to the port must have the same protocol running and the same transmission speed. Connect devices running different protocols to different ports of the ADAM-4570 series.



## 2.1.2 LED Indicators

There are three or four LEDs located on the top panel of ADAM-4570 series, each with its own specific function.

**Table 2.1: ADAM-4570 Series LED Definition**

LED	Color	Status	Description
Status/Power	Red	ON	Heartbeat (1 time/sec)
		OFF	Not working
	Green	ON	Power ON
		OFF	Power OFF
Speed/Link (Act)	Red	ON	100 Mbps speed
		OFF	10 Mbps speed
	Green	ON	Valid network link
		OFF	Invalid network link
Tx/Rx (Serial)	Red	ON	Data being transmitted
		OFF	No data being transmitted
	Green	ON	Data being received
		OFF	No Data being received

### 2.1.3 Dimensions (Unit: mm)

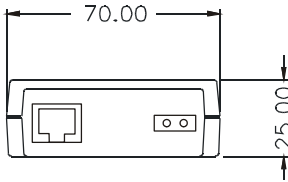

**Figure 2.1: Top Panel**

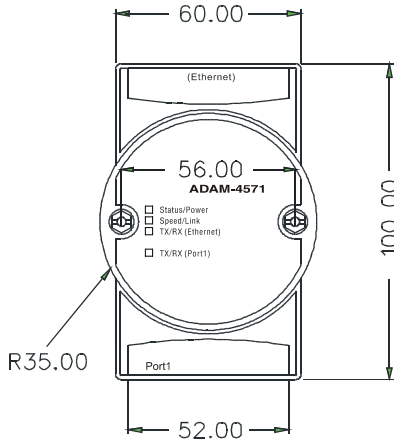

**Figure 2.2: Front Panel**

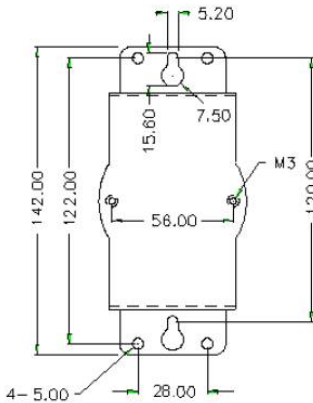

**Figure 2.3: Back Panel**

### 2.1.4 Stickers

If you forgot the IP addresses of specific ADAM-4570 series or where the host PC is mapped to the ADAM-4570 series port, we have provided five stickers for you to note the IP addresses and place in a secure location.

For example,

172.20.20.5: The IP address of specific ADAM-4570 series

160.59.20.89: The IP address of the specific host PC mapped to this port.

## 2.2 Connecting the Hardware

---

Next, we will explain how to find a proper location for your serial device server, and then explain how to connect to the network, hook up the power cable, and connect to the ADAM-4570 series's serial port.

*Note: Before you install ADAM-4570 series, you can install other communication cards first.*

### 2.2.1 Choosing a Location

Due to its versatile and innovative design, the ADAM-4570 series can be:

- Fixed to a panel mount
- Fixed to a DIN-rail.
- Piggyback Stack

## Panel Mounting

The ADAM-4570 series can be attached to a wall using the included metal brackets. Each bracket comes with four screws; first attach the brackets to the bottom of the ADAM-4570 series. Next, screw each bracket to a wall.

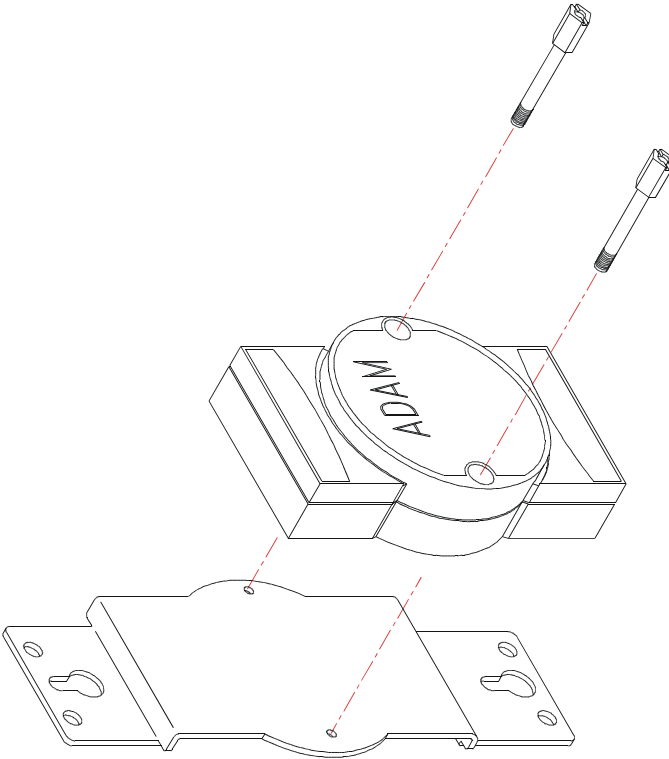
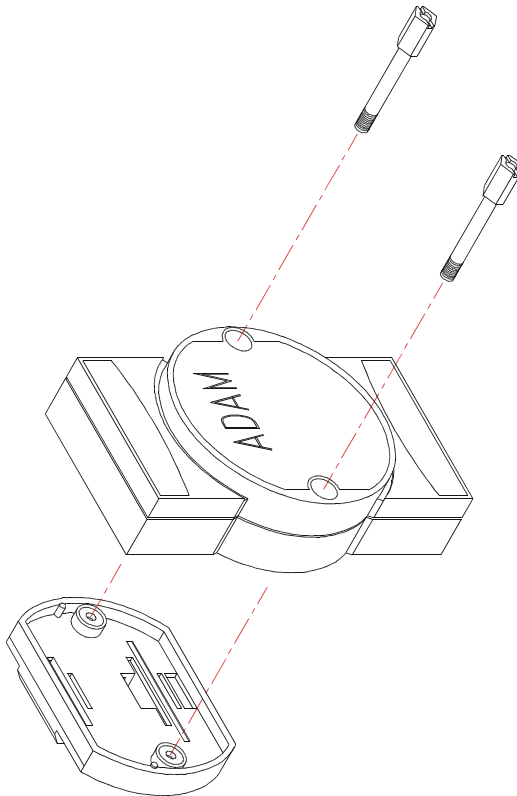

**Figure 2.4: Panel Mounting**

## DIN-rail Mounting

You can mount the ADAM-4570 series on a standard DIN-rail. First, using two screws, attach the metal plate to the DIN-rail bracket. Because the screw heads are beveled, the tops of the screws will be flush with the metal plate. DIN-rail Mounting Brackets—Orientation of Metal Plates

You can now screw the metal plate with the DIN-rail bracket assembly to the bottom of the server. Next, use the remaining screws to put the metal plate on the bottom of the ADAM-4570 series.



**Figure 2.5: DIN-rail Mounting**

## Piggyback Stack

ADAM-4570 series can be stacked as seen in the figure below.

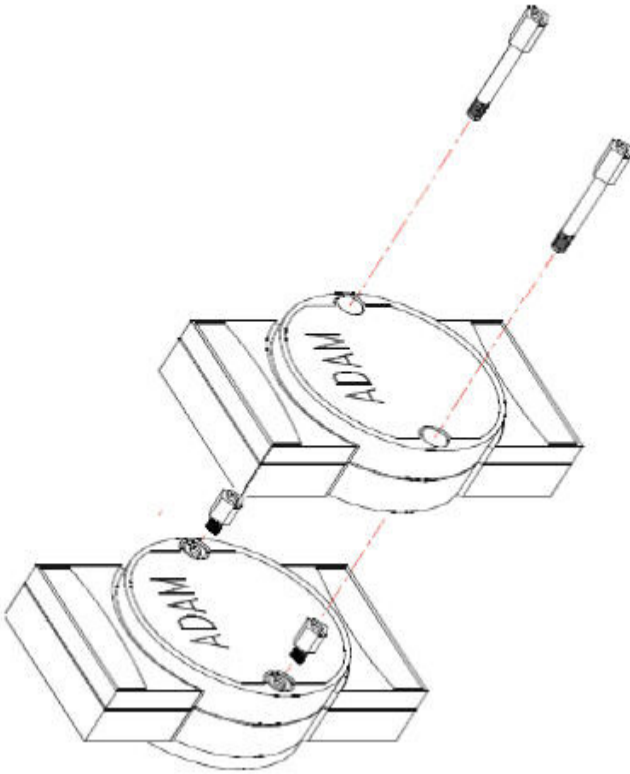

*Figure 2.6: Piggyback Stack*

## 2.2.2 Network Connection

There are two ways to use the 10/100Base-T Ethernet connector located on the ADAM-4570 series:

1. For Local Area Network (LAN) applications using the ADAM-4570 series, you will simply plug one end of your Ethernet cable into the 10/100Base-T connector, and the other end into the hub connected to your network.
2. When installing and configuring, you will find it convenient to hook the ADAM-4570 Series directly to your computer's Ethernet card. To do this you will need to use a "crossed-cable", such as the one supplied with your server.

### Cabling requirements for the Ethernet side

Use an RJ-45 to connect the Ethernet port of the ADAM-4570 series to the network hub. The cable for connection should be Category 3 (for 10Mbps data rate) or Category 5 (for 100 Mbps data rate) UTP/STP cable, which is compliant with EIA/TIA 586 specifications. Maximum length between the hub and any ADAM-4570 Series is up to 100 meters (ca.300 ft).

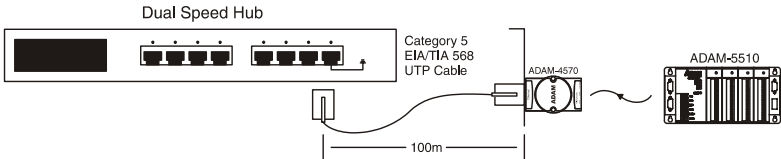
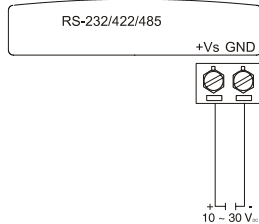

*Figure 2.7: Connecting ADAM-4570 Series to a Hub*

## 2.2.3 Power Connection

You should take the following steps to connect ADAM-4570 series power.

1. Connect the power cable to 2-pin connector
2. Connect power cable to power adapter



**Figure 2.8: Power Connection**

If the ADAM-4570 Series is working properly, the green power LED will light up, indicating that the ADAM-4570 Series is receiving power.

## 2.2.4 Serial Connection

The model of the ADAM-4570 Series that you purchased has RJ-48 serial ports or DB-9 male connector on the bottom of module. Depending on your serial device and serial interfaces, there are two options:

1. For an RS-232/422/485 port you may use a RJ-48 to DB-9 cable which we supply to connect your serial device to the ADAM-4570/4570L. Simply plug one end of the cable into the jack, and plug the other end into the serial port jack on your serial device.
2. Refer to the following table for details on serial cable RJ-48 to DB-9 pinouts.

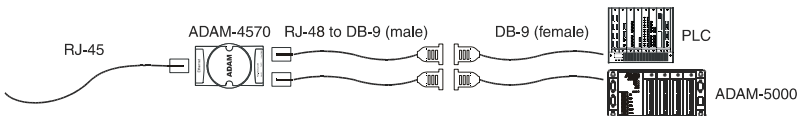

**Figure 2.9: Serial Connection**



## RJ-48

PIN Name	DCD	RX	TX	DTR	GND	DSR	RTS	CTS	RI
RJ-48	1	2	3	4	5	6	7	8	9

## DB-9

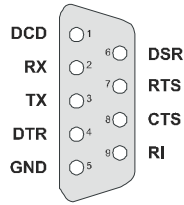

**RS-232**

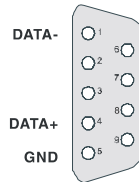

**RS-485**

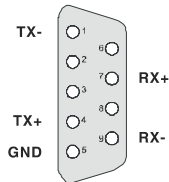

**RS-422**

## 2.3 Configuration Utility Installation

---

In order to use a PC and an Ethernet network to control serial devices connected to the ADAM-4570 Series, you must first have a host running Windows 2000/XP/Vista. This type of application also requires the host to have an Ethernet card and TCP/IP protocol installed. The following are the required steps for ADAM-4570 Series:

**Note:** *Be sure that you have at least version 2.0 of the Microsoft .NET Framework installed on your PC.*

1. Insert the Advantech IEDG series driver utility CD-ROM into the drive (e.g. D:\) on the host PC. Change the host computer's default drive from C: to D:
2. Use your Windows Explorer or the Windows Run command to execute the Setup program (the path for the Setup program on the CD-ROM should be on the CD-ROM should be:

D:\Utility&Driver\Serial Device Server Configuration Utility\Serial\_Device\_Server\_Configuration\_Utility\_[Version]\_Release\_[Date].exe

3. Upon executing the setup program, the Welcome Dialog Box will pop-up. Press the "Next" button to continue.

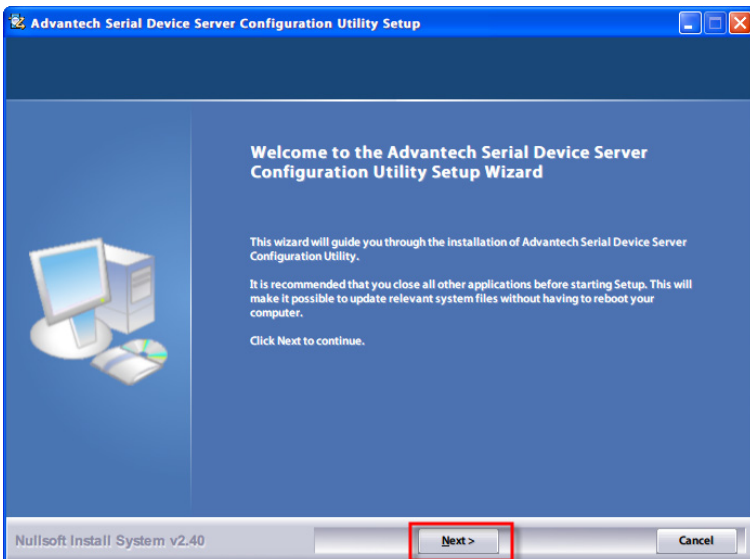

- Carefully read the Software License Agreement, and press "Yes" to continue.

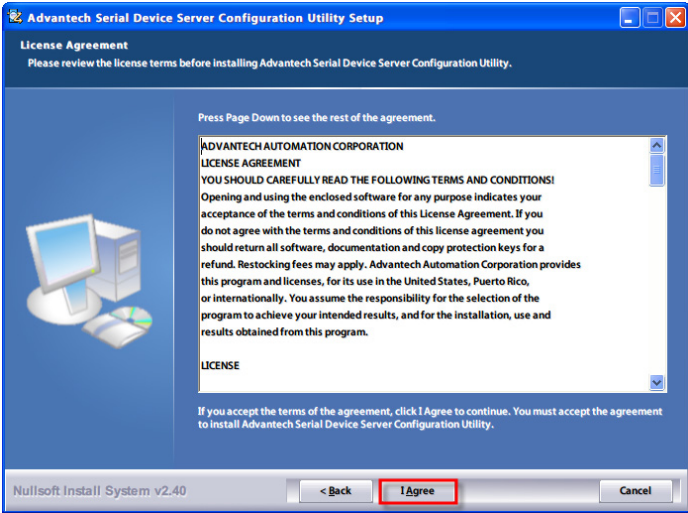

- The Setup program will specify a default installation path:  
Advantech eAutomation\Serial Device Server Configuration Utility\

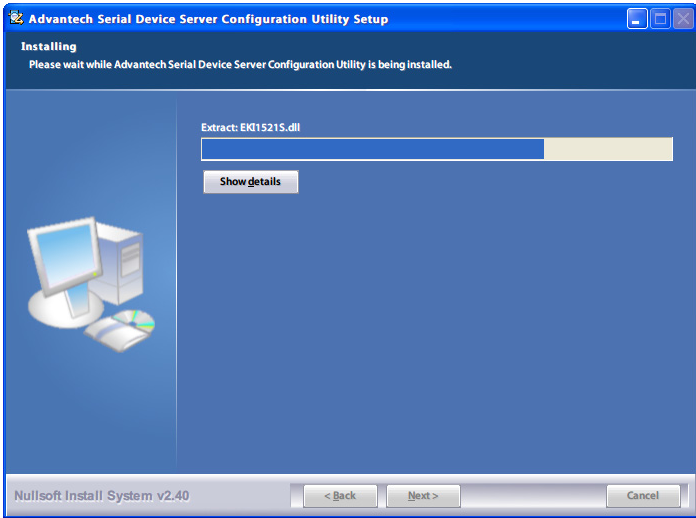

7. After setup has copied all program files to your computer, click the <Finish> button to finish the installation.

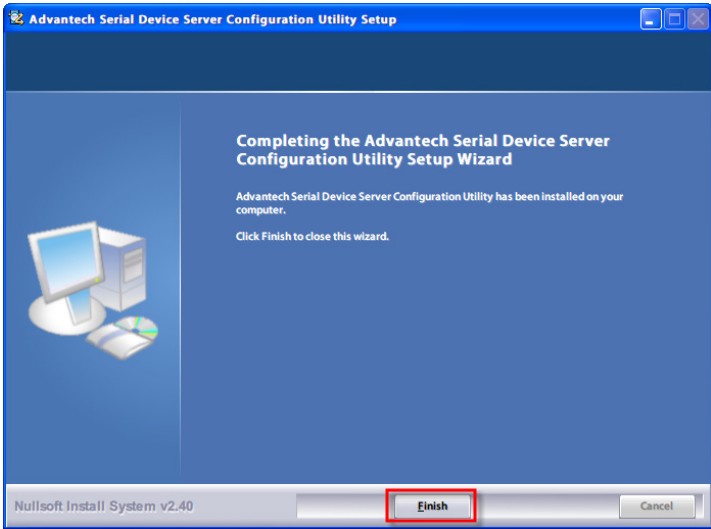

CHAPTER  
**3**

# Configuration

# Chapter 3 Configuration

## 3.1 Serial Device Server Configuration Utility Overview

---

The ADAM-4570 series provides an easy-to-use configuration utility to configure your serial device server through an Ethernet connection. For secure administration, it can also restrict the access rights for configuration to only one host PC to enhance network security. With this secure function enabled, other PCs will not have permission for configuration. After the installation program on the Advantech IEDG Series Driver Utility CD-ROM is finished, the serial device servers will be ready for use and configure.

Advantech Serial Device Server Configuration Utility is an excellent device server management tool. You can connect and configure the local and remote Advantech serial device servers easily. Moreover, Virtual COM port will be enabled in the same utility. Using this utility, you can:

- Configure the network settings (you can set the IP address, Gateway address, and Subnet mask)
- View and set the serial port parameters (configure operating mode, baud rate, serial port settings and operating mode settings)
- Perform diagnostic tests (virtual COM port testing, port status list)
- Perform administrative functions (export and import the serial device server setting, manage access IP, a descriptive name, upgrade firmware)
- Configure COM port redirector(virtual COM port)

You may open the Serial Device Server Configuration Utility from the Windows Start Menu by clicking **Start → All Programs → Advantech eAutomation → Serial Device Server Configuration Utility**. The Serial Device Server Configuration Utility will appear as below figure.

There are four major areas in the serial device server configuration utility.

1. Serial Device Server List Area: All devices will be searched and listed in this area. You can arrange different favorite group and virtual COM ports.
2. Serial Device Server Information Area: Click on the serial device server or move cursor to the serial device server, the related information will be shown on this area.
3. Configuration Area: Click on the item on the Device Server List Area, the configuration page will display on the area.
4. Quick Tool Bar: Useful management functions shortcut.

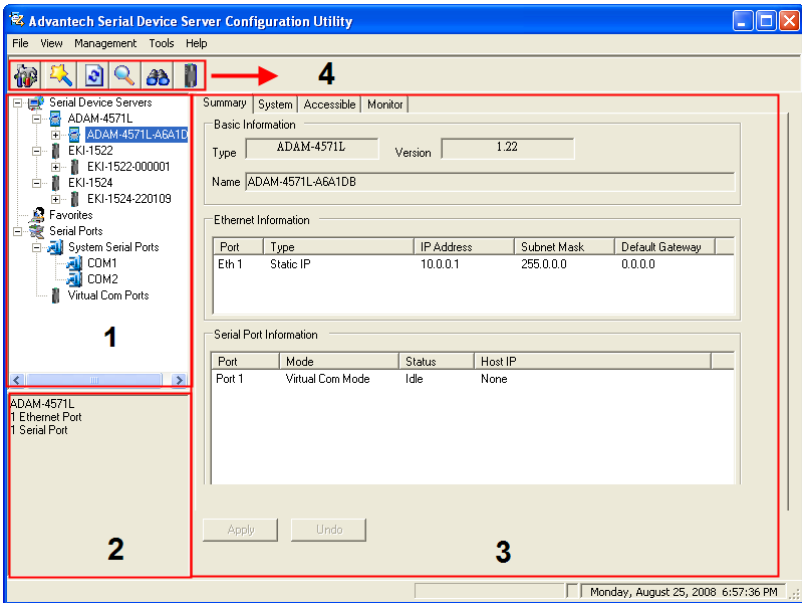

**Note:** Please reserve TCP/UDP port 5048 and 5058 in your Ethernet network, configuration utility will use these ports to communicate with Advantech EKI-1000, EDG-4500, and ADAM-4570 serial device servers.

## 3.2 Discovering Your Serial Device Server

### 3.2.1 Auto Searching

Advantech Serial Device Server Configuration Utility will automatically search all the EKI-1000, EDG-4500, and ADAM-4570 series device servers on the network and show them on the Serial Device Server List Area of the utility. The utility provides an auto-search function to show your device(s) by simply executing the configuration utility program from the Start Menu.

From here all device on the same network domain will be searched and display on Device Server List Area. You can click on the device name to show the features of the specific device. Click on the "+" before the model name (e.g. ADAM-4570), and the utility will expand the tree structure to show the individual device name. Click on the "-" before the model name (e.g. ADAM-4570), and the utility will collapse the tree structure.

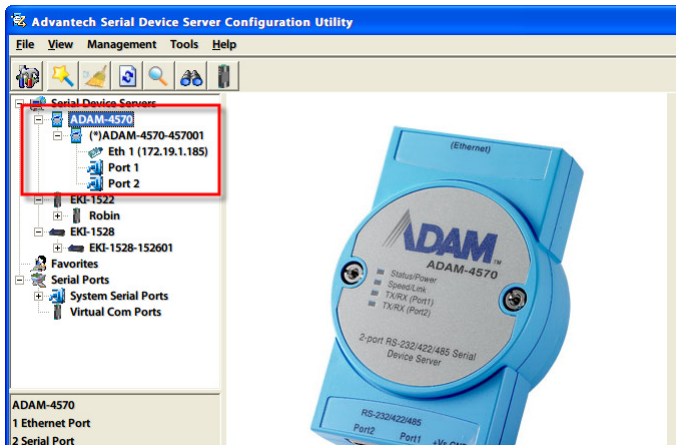

For Example, the ADAM-4570 in this figure is shown "ADAM-4570-457001" after expanding the tree structure.



*Note* When you run the Configuration Utility for the first time, the default device name is "MAC ID". In this case, the device name "ADAM-4570-457001" means the device "MAC ID" is "00 D0 C9 45 70 01". You can change the default device name in System Tab of Device Properties.

Select the device in this sub-tree. The first tab on the "Configuration Area" shows the summary of "Basic Information" included device type, version, and name, "Ethernet Information", and "Serial Port Information". In the serial port information frame, it displays the operation mode, status and connected host IP.

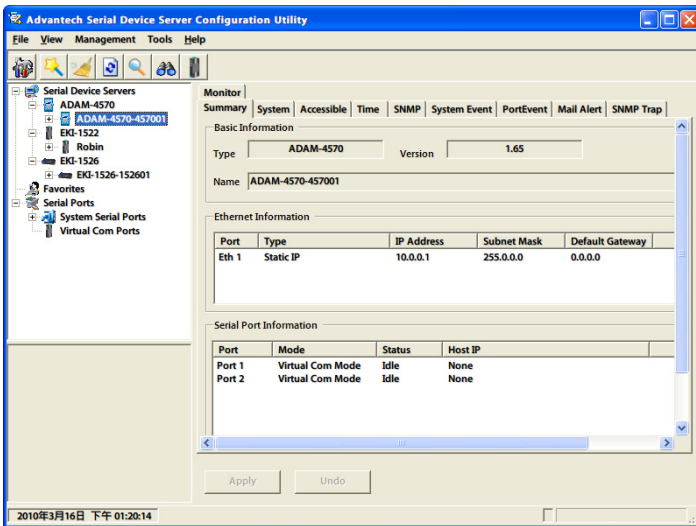

Click on the "+" before the device name, and the utility will expand the interfaces on this device server.

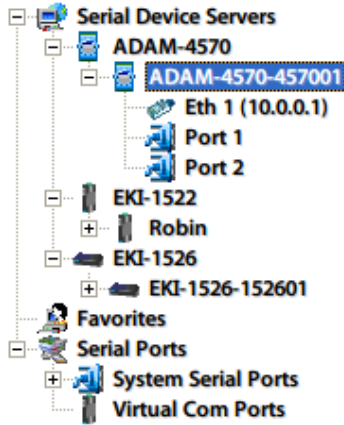

Click on each item, you will enter the configuration page to change the setting. The configuration will be introduced on following sections.

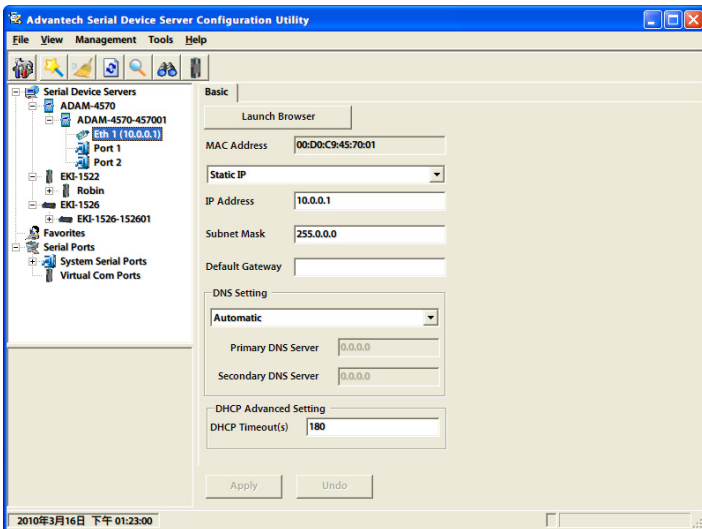

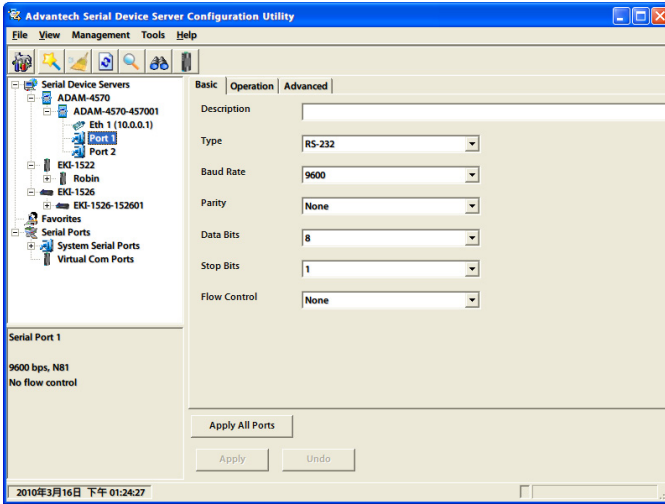

### 3.2.2 Clearing the Device List and Searching Again

You can click the  button on the “Quick Tool Bar”; utility will clear all list device servers in the Serial Device Server List Area and re-search again. Don’t use this function frequently. The warning message will be pop-up when you double click this button.

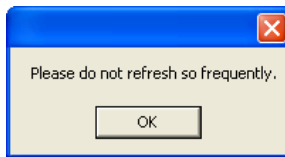

You can click the  button on the “Quick Tool Bar”; utility will search serial device server on local LAN.

### 3.2.3 Manual Appending

Using “Add IP address to Favorite” or “Search a Range of IP addresses” function, you are able to add one device or group of devices to “Favorites”. These devices can locate on local network domain or other network domain.

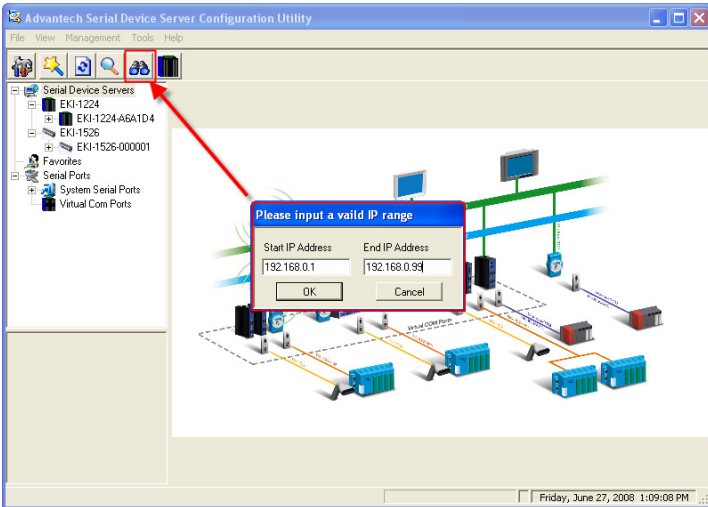
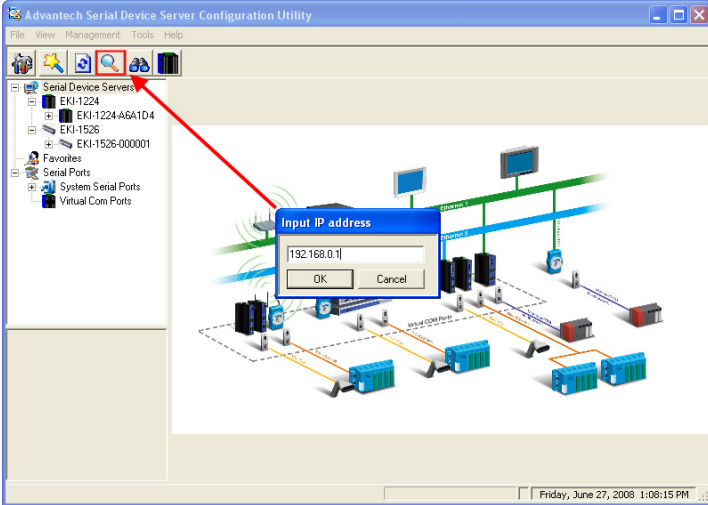

### 3.3 Setting Ethernet Parameters

This section explains how to configure the ADAM-4570 series network using this utility so that it can communicate over a network with serial devices.

Click on the "+" before the model name (e.g. ADAM-4570), and the utility will expand the tree structure to show the individual device name. And click on the "+" before the device name, and the utility will expand the interfaces on this device server. Select the Ethernet interface (Eth1).

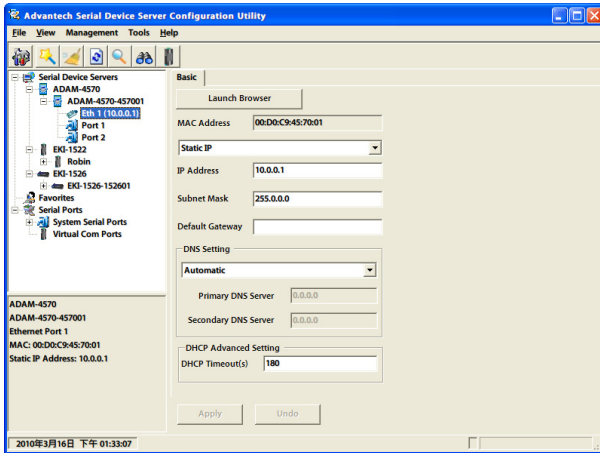

#### MAC Address:

The MAC address is for the local system to identify and locate each serial device servers. This MAC address is already set before delivery from factory, hence no need for further configuration.

#### IP Address, Subnet Mask, Default Gateway:

The IP address identifies your Advantech serial device server on the global network. Each ADAM-4570 series has the same default IP address 10.0.0.1. Obtain these specific IP addresses from your network administrator and then configure each Advantech serial device server with individual IP addresses, related Subnet Mask and Gateway Setting.

You can choose from four possible IP configure modes: Static, DHCP, BOOTP, and DHCP/BOOTP.

### **Static IP**

User defines IP address, Subnet Mask, Default Gateway, and DNS.

### **DHCP + Auto-IP**

DHCP server assigns IP address.

### **BOOTP + Auto-IP**

BOOTP server assigns IP address.

### **DHCP + BOOTP + Auto-IP**

DHCP server assigns IP address, Subnet Mask, Default Gateway, and DNS or BOOTP server assigns IP address (If DHCP server does not respond).

### **DNS Setting**

In order to use DNS feature, you need to set the IP address of DNS server to be able to access the host with the domain name. The ADAM-4570 serial device server provides Primary DNS server and Secondary DNS server configuration items to set the IP address of the DNS server. Secondary DNS server is included for use when Primary DNS sever is unavailable.

## DHCP Timeout(s)

If you select DHCP as IP configuration mode, the ADAM-4570 will retry DHCP timeout(s) (default: 180s) until network settings are assigned by the DHCP server. If the DHCP/BOOTP server is unavailable, the ADAM-4570 will use Address auto configuration (based on RFC 3330 and RFC 3927) for IP setting.

*Note When you have finished the configuration of these settings for each category, please press the “Apply” button in order to make these settings effective on the Serial Device Server. (Will reboot your Serial Device Server)*

## 3.4 Setting Serial Parameters

---

This section explains how to configure the ADAM-4570 series serial communication parameters using this utility. There are various operation modes that are suitable for different application.

Click on the "+" before the model name (e.g. ADAM-4571L), and the utility will expand the tree structure to show the individual device name. And click on the "+" before the device name, and the utility will expand the interfaces on this device server. Select the serial interface (Port1).

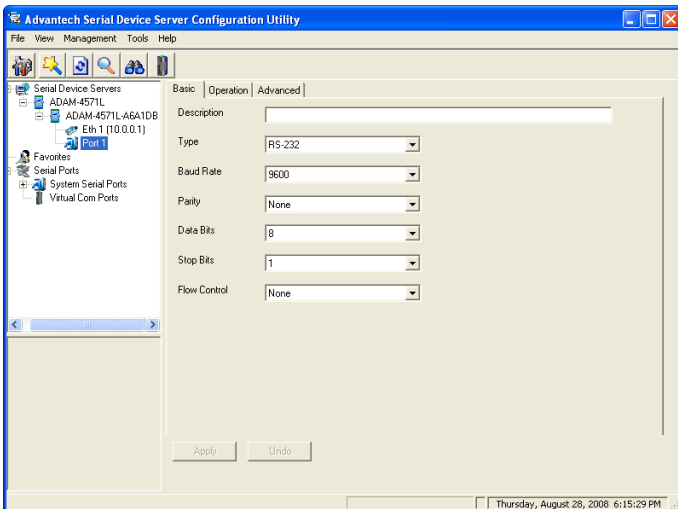

### 3.4.1 Basic Configuration

#### Description:

You can give a more detailed description on the function of the port for easier management and maintenance. Descriptions have a limit of 128 characters.

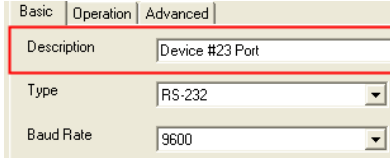

The screenshot shows a configuration window with three tabs: Basic, Operation, and Advanced. The Basic tab is selected. The Description field is highlighted with a red border and contains the text "Device #23 Port". Below it, the Type is set to "RS-232" and the Baud Rate is set to "9600".

#### Baud Rate:

The ADAM-4570 series supports baud rate from 50 to 921.6Kbps. While setting the baud rate, please note that the value should conform to the current transmission speeds of connected devices.

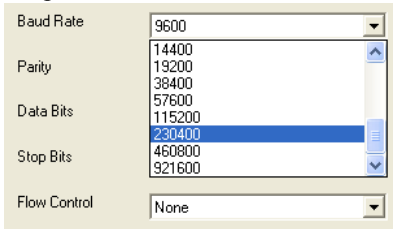

The screenshot shows a configuration window with a list of baud rates. The Baud Rate field is set to "9600". The list of baud rates includes: 14400, 19200, 38400, 57600, 115200, 230400 (highlighted), 460800, and 921600. The Parity field is set to "None".

#### Parity:

ADAM-4570 series provides 5 options: None, Odd, Even, Space, and Mark.

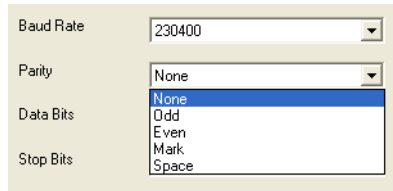

The screenshot shows a configuration window with a list of parity options. The Baud Rate field is set to "230400". The Parity field is set to "None". The list of parity options includes: None (highlighted), Odd, Even, Mark, and Space.



**Data Bits:**

The ADAM-4570 series provides four options: 5, 6, 7 and 8.

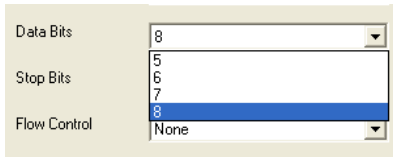

A configuration window with three sections: 'Data Bits' with a dropdown menu showing '8'; 'Stop Bits' with a list box containing '5', '6', '7', and '8', where '8' is selected; and 'Flow Control' with a dropdown menu showing 'None'.

**Stop Bits:**

The ADAM-4570 series provides three options: 1, 1.5 and 2.

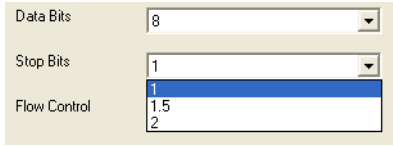

A configuration window with three sections: 'Data Bits' with a dropdown menu showing '8'; 'Stop Bits' with a dropdown menu showing '1'; and 'Flow Control' with a list box containing '1', '1.5', and '2', where '1' is selected.

**Flow Control:**

The ADAM-4570 series provides four options: None, XOn/XOff, RTS/CTS, and DTR/DSR.

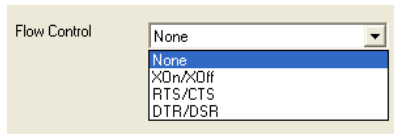

A configuration window with a 'Flow Control' section containing a dropdown menu with 'None' selected and a list box showing 'None', 'XOn/XOff', 'RTS/CTS', and 'DTR/DSR'.

## 3.4.2 Operation Mode Configuration

### COM Redirector Setting:

The Advantech serial device servers extend traditional COM ports of a PC to Ethernet access. Through Ethernet networking, users can control and monitor remote serial devices and equipments over LAN or WAN. Advantech serial device servers come with a COM port redirector (Virtual COM driver) that transmits all serial signals intact. This means that your existing COM-based software can be preserved, without modifying to fulfill the needs. The Virtual COM mode allows user to continue using RS-232 serial communications software that was written for pure serial communication applications.

The ADAM-4570 series comes with COM port redirector (virtual COM driver) that work with series comes with COM port redirector Window 2000/XP/Vista systems. The driver establishes a transparent connection between host and serial device by mapping the IP of Advantech serial device server serial port to a local COM port on the host computer.

The ADAM-4570 series provides Multi-access function through Ethernet connection path. Allow the maximum of 5 connections to open one serial port simultaneously. In this mode, all connection has to use the same serial setting. If one serial setting of these connections is different from others, the data communication may operate incorrectly.

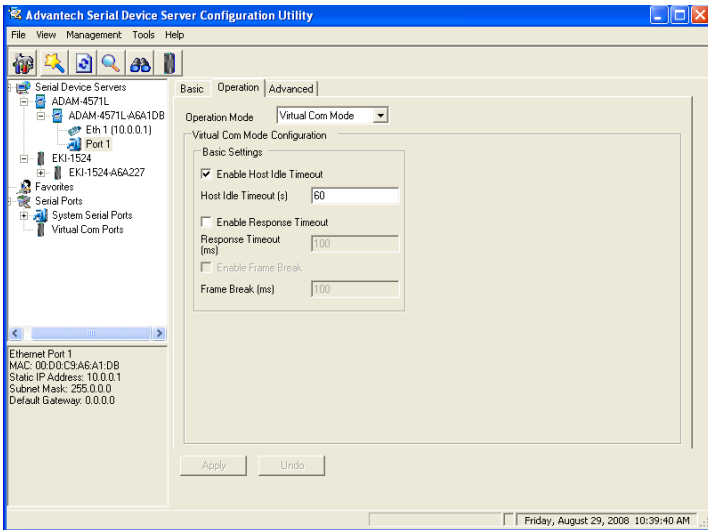

### **Host Idle Timeout (10 to 255 seconds):**

The "Host Idle Timeout" setting monitors the connection between the host and the device. If the "Host Idle Timeout" setting time is reached, the device server will release the resources allocated to the port mapping. This prevents a stalled host from affecting the connective device.

*Note* The default value of "Host Idle Timeout" is 60 seconds.

The ADAM-4570 series provides Multi-access function through Ethernet connection path. Allow the maximum of 5 connections to open one serial port simultaneously. In the mode, all connection has to use the same serial setting. If one serial setting of these connections is different from others, the data communication may operate incorrectly.

There are two operating mode of Multi-access function. One is **Normal mode**; another is **Round-Robin mode**.

#### **Normal mode:**

Disabling "Response Timeout" parameter, the ADAM-4570 series will operate in "normal mode". When multiple hosts open the serial port simultaneously, the ADAM-4570 series only offers control ability for the first connected host and provides data communication function for others. Each serial port supports up to five simultaneous connections, so multiple hosts can transmit/receive data to/from the same serial port simultaneously. Every host can transmit data to the same serial port, and the ADAM-4570 series will also transmit data to every hosts. When the multiple hosts transmit data to the same serial port at the same time, the received data from Ethernet and the outputs of serial port are mixed. When the ADAM-4570 series receives data from serial port, the data will also be transmitted to the connected hosts simultaneously.

*Note* This operating mode is suitable for the one major host send the command and others hosts just listen the data from serial port. If two of connected hosts send the command at the same time, it is possible that ADAM-4570 series serial device server will not handle the command and will response the incorrect data.

### **Round-Robin mode:**

Enabling “Response Timeout” parameter, the ADAM-4570 series will operate in “Round-Robin mode”. Each serial port supports up to five simultaneous connections, so multiple hosts can transmit/receive data to/from the same serial port simultaneously. Every host can transmit data to the same serial port simultaneously, but the ADAM-4570 series will process the data communication in order. ADAM-4570 series will process the first host’s request and reply the response to the first host. ADAM-4570 serial device server can determine the end of the serial acknowledgement via response timeout. When ADAM-4570 serial device server receives nothing from serial port after the setting of response timeout, the device will reply the acknowledgement to the host and then process the next host’s request. While the connected hosts are more and “Response Timeout” is long, the process time is much longer.

**Frame Break** is a very import parameter for Round Robin mode. This parameter is the smart way to reduce inefficient waiting time and the ADAM-4570 series can transmit data more efficiently. Disabling the Frame Break function, the ADAM-4570 series will wait “Response Timeout” period, whether the device have transmitted the data. During this period, the commands from hosts will be queued and the ADAM-4570 series just processes this command. Enabling “Frame Break”, if the serial port idle is longer than the “Frame Break” period, ADAM-4570 series will assume the communication is completed and continue the next host’s query. This is an efficient way to reduce the waiting time and improve the performance.

### **3.4.3 Data Mode (USDG Mode)**

The ADAM-4570 series can be Data Server or Data Client either. Both operations support TCP and UDP protocol. The ADAM-4570 series makes your serial devices behave just like networking devices. You can issue commands or transmit data from serial devices, which connected to the ADAM-4570 series, to any devices that are connected to the Internet.

The ADAM-4570 series allows most 5 host PCs accessing data simultaneously via polling networking architecture. You can use it according to your application. If you want to access the ADAM-4570 series, you must ascertain your application software supports standard networking application programming interface (API) such as: WinSock Socket.

You might select “USDG Mode” as the following figure to change the mode of the port to TCP server/client or UDP mode.

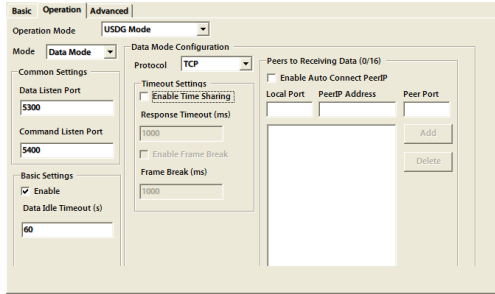

## Protocol

The ADAM-4570 series provides TCP/IP and UDP two protocols. In settings, you can choose either TCP mode or UDP mode according to your application.

## Data Listen Port

The TCP/UDP port number represents the source port number, and the number is used to identify the channel for remote initiating connections. Range: 1024-65533. If an unknown caller wants to connect to the system and asks for some services, they need to define the TCP/UDP port to carry a long-term conversation.

Each node on a TCP/IP network has an IP address, and each IP address can allow connections on one or more TCP port. The well known TCP ports are those that have been defined; for example, port 23 is used for Telnet connections. There are also custom sockets that users and developers define for their specific needs. The default TCP/UDP port of the ADAM-4570 series is 5300. The example initial 5300 is System Port, and 5301 is Data Port. But users can adjust them by one's preference or application.

Each port has its own data listen port to accept connected request of other network device. So, the data listen port can't be set the same value. You can transmit/receive data to/from device via the data listen port.

## Command Listen Port

Each port has its own command listen port to accept connected request of other network device. So, the command listen port can't be set the same value. You can use 'AT command' to change the port setting via the command listen port. The Command Listen Port should be different from the Data Listen port.

## Data Idle Timeout

The default is 60 seconds. If you want to keep connection continually, you can disable the Data Idle Timeout. Data idle Time is the time period in which the device waits for data. If the ADAM-4570 series does not receive data over an established idle time, the ADAM-4570 series will disconnect temporarily. When the data comes to the ADAM-4570 series, it will reconnect automatically. Users do not need to reconnect.

## Enable Time Sharing

The ADAM-4570 series provides Multi-access function through Ethernet connection path. Allow the maximum of 5 connections to open one serial port simultaneously. In the mode, all connection has to use the same serial setting. If one serial setting of these connections is different from others, the data communication may operate incorrectly.

There are two operating mode of Multi-access function. One is **Normal mode**; another is **Round-Robin mode**.

### • Normal Mode

Disabling "*Response Timeout*" parameter, the ADAM-4570 series will operate in "normal mode". When multiple hosts open the serial port simultaneously, the ADAM-4570 series only offers control ability for the first connected host and provides data communication function for others. Each serial port supports up to five simultaneous connections, so multiple hosts can transmit/receive data to/from the same serial port simultaneously. Every host can transmit data to the same serial port, and the ADAM-4570 series will also transmit data to every hosts. When the multiple hosts transmit data to the same serial port at the same time, the received data from Ethernet and the outputs of serial port are mixed. When the ADAM-4570 series receives data from serial port, the data will also be transmitted to the connected hosts simultaneously.

- **Round-Robin Mode**

Enabling “*Response Timeout*” parameter, the ADAM-4570 series will operate in “Round-Robin mode”. Each serial port supports up to five simultaneous connections, so multiple hosts can transmit/receive data to/from the same serial port simultaneously. Every host can transmit data to the same serial port simultaneously, but the ADAM-4570 series will process the data communication in order. The ADAM-4570 series will process the first host’s request and reply the response to the first host. The ADAM-4570 series serial device server can determine the end of the serial acknowledgement via response timeout. When ADAM-4570 series serial device server receives nothing from serial port after the setting of response timeout, the device will reply the acknowledgement to the host and then process the next host’s request. While the connected hosts are more and “Response Timeout” is long, the process time is much longer.

**Frame Break** is a very import parameter for Round Robin mode. This parameter is the smart way to reduce inefficient waiting time and the ADAM-4570 series can transmit data more efficiently. Disabling the Frame Break function, the ADAM-4570 series will wait “Response Timeout” period, whether the device have transmitted the data. During this period, the commands from hosts will be queued and the ADAM-4570 series just processes this command. Enabling “Frame Break”, if the serial port idle is longer than the “Frame Break” period, the ADAM-4570 series will assume the communication is completed and continue the next host’s query. This is an efficient way to reduce the waiting time and improve the performance.

**Peer Number**

Set the number of network device which you want to connect. You can set maximum sixteen network devices which you want to connect. You need to fill out the IP Address and Port of network devices which you want to connect.

Peers to Receiving Data (0/16)

Local Port	PeerIP Address	Peer Port
<input type="text"/>	<input type="text"/>	<input type="text"/>

### 3.4.4 Control Mode (USDG Mode)

In controlling mode, the ADAM-4570 series presents a modem interface to the attached serial device: it accepts AT-style modem commands to connect / disconnect to other networking device. If you want serial device running application program to connect/disconnect to different devices dynamically, you can use controlling mode.

The “Control mode” provides three kinds of modem AT-style commands. The serial devices can use these commands to control the ADAM-4570 series to connect/disconnect to remote networking device. Thus, intelligent serial devices such as standalone PLC will send /receive data to/from devices one by one via Ethernet.



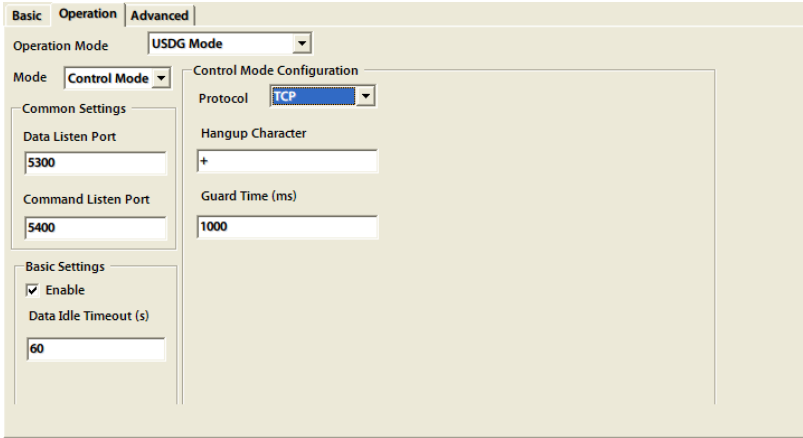

Please refer to the *Data Mode (USDG Mode)* to setup the Data Listen Port, Command Listen Port, and Data Idle Timeout.

### Hangup Character

The default character is “+”. After you have connected to another serial device via ADAM-4570 series, you may need to disconnect. Then you can use the command "+++" to disconnect. To do this leaves your keyboard idle (don't press any keys) for at least several seconds, then press "+" three times. You can set "Guard Time" to define the idle time. Be sure that you have to press "+" over the idle time.

### Guard Time

The default value is 1000 ms.

*Example: <Guard Time> + <Guard Time> + <Guard Time> +*

The following commands are available for the ADAM-4570 series.

### 3.4.5 AT Command List

Command	Function
ATDT<IP address> <TCP port> <CR>	“Forms a TCP connection to the specified host. Ex: ATDT 192.0.55.22:5201 In above example, the ADAM-4570 series serial device server forms a raw TCP connection to the networking device (192.0.55.22). The TCP port is 5301.”
ATA <CR>	Answering an incoming call
+++<CR>	Returns the user to the command prompt when entered from the serial port during a remote host connection.
<LF><CR> OK <LF><CR>	Commands are executed correctly
<LF><CR> CONNECT <LF><CR>	Connect to other device
<LF><CR> RING ddd.ddd.ddd <LF><< CR>	Detect the connection request from other device, which IP address is ddd.ddd.ddd.ddd.
<LF><CR> DISCONNECT <LF><CR>	Disconnect from other device
<LF><CR> ERROR <LF><CR>	Incorrect commands
<LF><CR> FAIL <LF><CR>	If you issue an ATDT command and cannot con- nect to the device, it will response “FAIL”.

### 3.4.6 Advanced Settings

The serial device server provides the advanced settings for some special applications which need critical time requirements. In normal applications, these settings are recommended not to be set to avoid the unusual action happened.

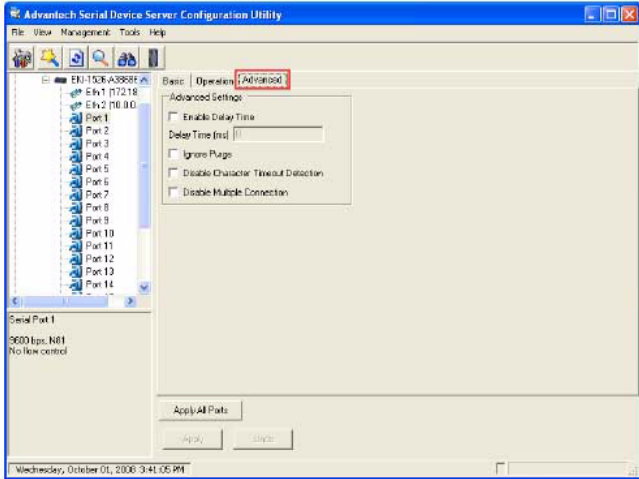

#### **Delay Time (ms)**

When enabled, the serial port will postpone the received data for the time interval you set, and then send the received data to the TCP/IP network.

#### **Ignore Purge**

Some application program will purge the serial port the first time opens this serial port. You can ignore the purge command by enable this option.

#### **Disable Character Timeout Detection**

Enable this option will disable the serial port character timeout detection.

#### **Disable Multiple Connection**

Enabling this option will disable the multi-access function, thus the only one TCP connection is allowed on this serial port.

*Note* These settings are just for special applications. We recommend not enabling advanced settings in normal usage.

## 3.5 Security Configuration

### 3.5.1 Accessible Function

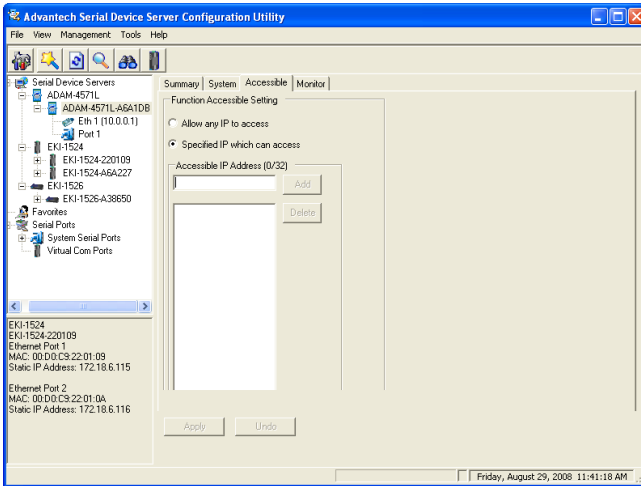

#### **Allow any IP to access:**

The default option, any host PC can communicate with this serial device server.

#### **Specified IP which can access:**

Type the IP address in the column and click “Add” or “Delete” button to make the accessible IP address list. The limit of this list is 32 IP addresses.

### 3.5.2 Port Monitor

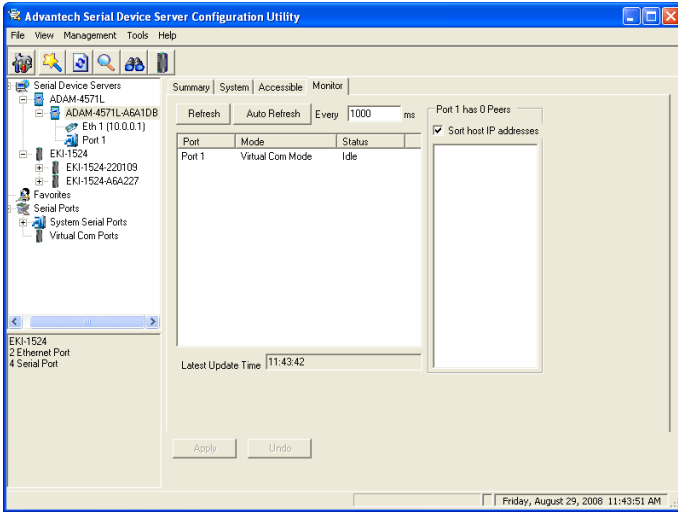

Configuration utility provides an excellent function that allows monitoring the serial ports' status. It will present each serial port's operation mode and status. The IP address of Host PC which is communicating with serial port will be list on the right window. Click "Refresh" button, the status will be refresh once. It will be auto refresh after click "Auto Refresh" and the time duration is depending on the setting (the default value is 1000ms).

## 3.6 Fulfilling Administrator Functions

The configuration utility provides several administrator settings for easy management and configuration. Right click the mouse on the device name in the sub-tree of Serial Device Sever List Area, and select these administrator settings.



### 3.6.1 Import/Export Serial Port Setting

The utility allows importing or exporting the serial port setting including “Basic Setting” and “Operation Setting” via “.sps” file format.

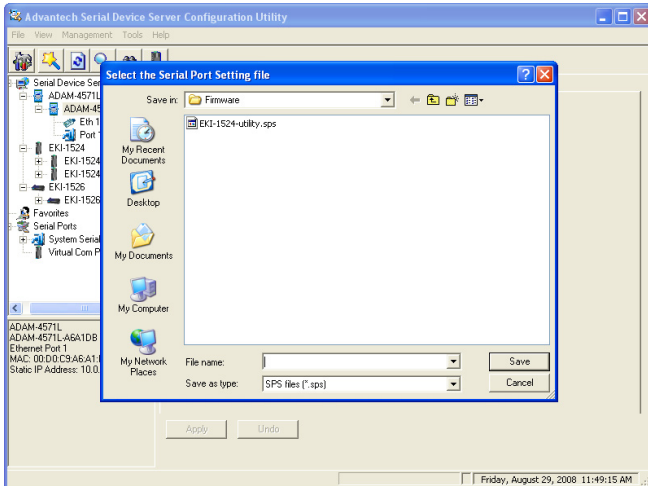

### 3.6.2 Locate Serial Device

If there are many serial device servers need your management, you may need to identify which unit is correct to configuration on utility. Click “Locate” to make that unit’s “Status” LED be steady on until you click “Stop Locate”.

### 3.6.3 Lock Device

The configuration utility provides the “Lock Device” function to make it more confidential. You need to set up a password while the first time clicking “Lock Device”. Be sure to click “Reset Device” to restart the serial device server and store your setting password into the memory.

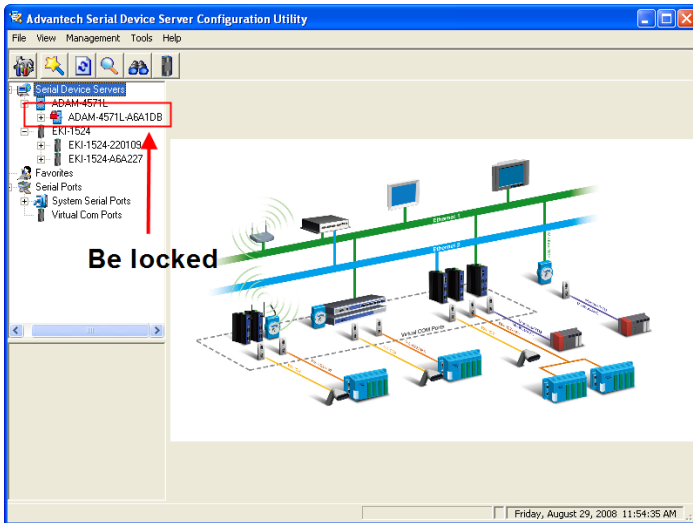

Click “Unlock Device” to unlock the serial device server, and you need to fill in the password you have set up before. If you forgot the password, the only way to solve this problem is to restore the setting of the serial device server to the factory default which will be introduced next section.

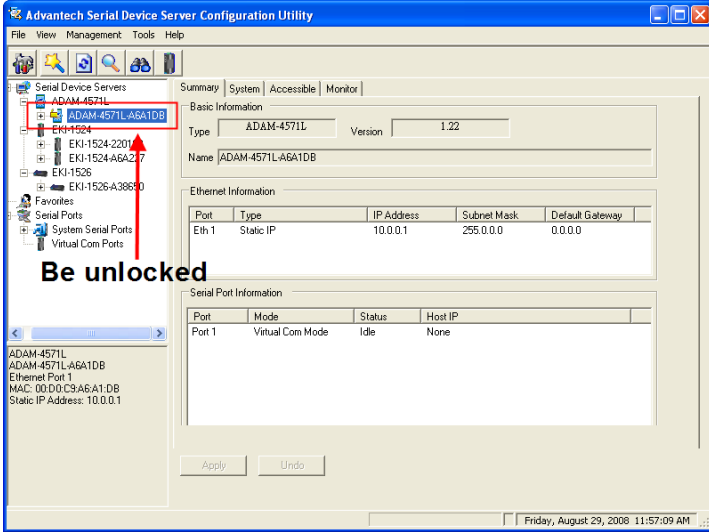

If you want to disable this function or change the password, click “Change Password” to change the password to default “None” (leave the new password and confirm new password columns blank) to disable this function or other password you want to change. Be sure to click “Reset Device” to restart the serial device server and store the new password into the memory.

### 3.6.4 Restore to Factory Default Settings

The configuration utility provides this function to let you can restore the serial device server to factory default settings. The confirm message will be pop-up while clicking “Restore to Factory Default Settings”. If you really want to restore the serial device server to factory default settings, please click “Yes” button to continue.

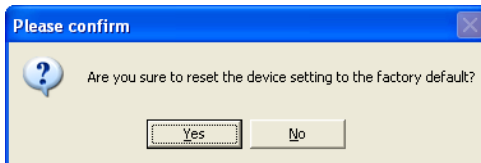



Then, please power off the serial device server within ten seconds, after reconnecting the power back, the all setting will be reset to the factory default. If the power remains more than ten seconds, the serial device server will not have any changes.

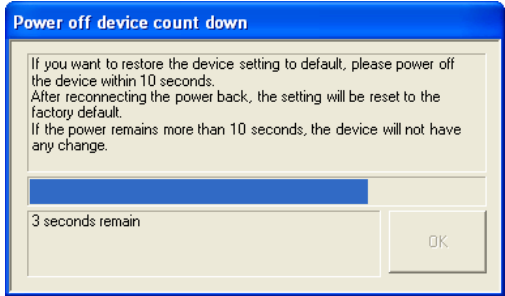

### 3.6.5 Upgrading the Firmware

Advantech continually upgrades its firmware to keep up with the ever-expanding world of computing. You can use the update firmware function in the utility to carry out the upgrade procedure. Please access Advantech's Website at <http://www.advantech.com> to download the latest version of the firmware.

Right click on the device name and select "Update Firmware" function.

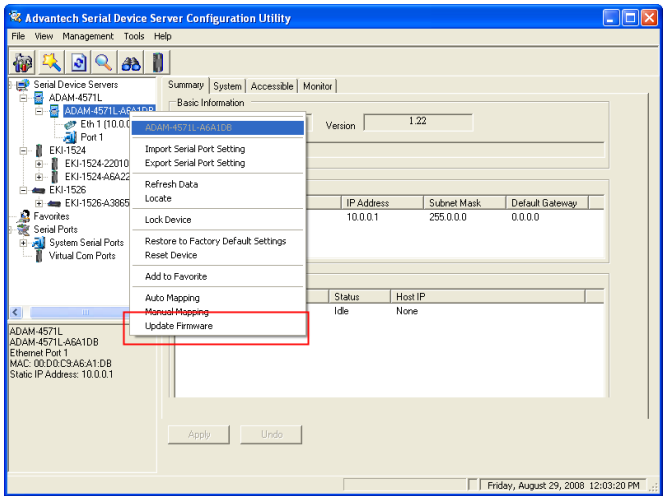

Select the firmware you want to update.

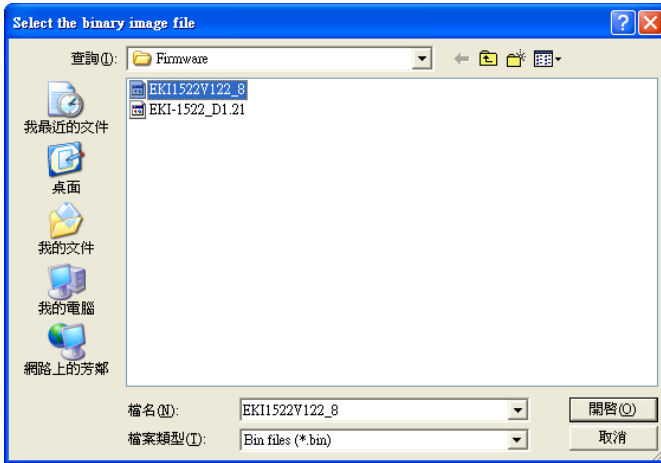

After downloading the firmware completely, click on the “OK” button. The serial device server will restart automatically.

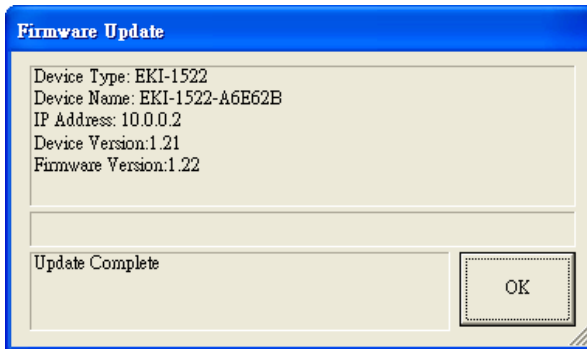

**Note:** Be sure that the host PC Ethernet network domain is as same as the ADAM-4570 series device server while doing the updating firmware process.

CHAPTER  
**4**

**Setting the COM  
Redirector**

# Chapter 4 Setting the COM Redirector

Advantech Serial Device Server Configuration Utility also creates virtual COM ports that Windows applications will use to communicate with remote serial devices. Advantech virtual COM ports follow the same naming/numbering convention as Windows COM ports.

## 4.1 Setting COM Redirector (Virtual COM port)

Advantech COM port mapping software is a serial COM port redirector that creates virtual COM ports and provides access to serial devices connected to Advantech serial device servers. Your serial device applications can communicate with serial devices connected to Advantech serial device servers without software changes. Since the virtual COM ports work like standard Windows COM ports, your application software sees no difference between a local serial device and one connected to a Advantech serial device server.

COM redirector utility and Virtual COM port Management utility are integrated into one utility with same GUI. Advantech Serial Device Server Configuration Utility can create all Virtual COM ports using “Auto Mapping” function. You can map the Virtual COM port by yourself.

### 4.1.1 Auto Mapping

Right click the serial device name on the sub-tree of Device Server List area and select the “Auto Mapping” function.

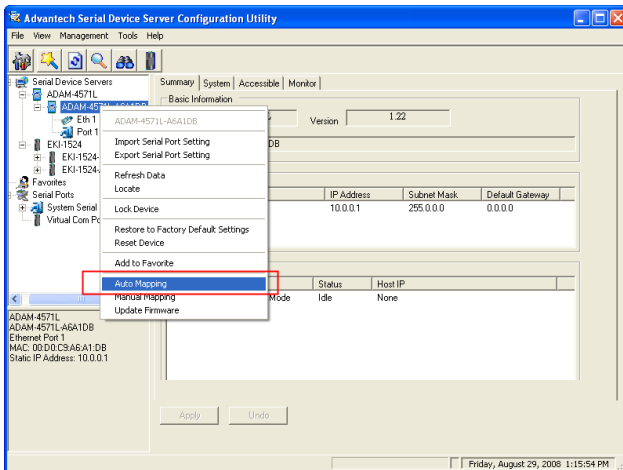

The serial ports that can be assigned to virtual COM will be shown in this window. Select the serial ports you wish to map or click the <Select All> button and press <Map Selected Ports> button. The selected serial ports will be mapped to virtual COM ports in sequential order.

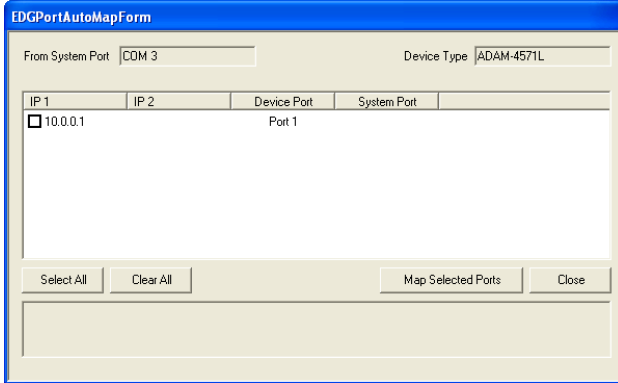

The COM ports in the “Virtual Com Ports” listing are now available for use by Windows applications.

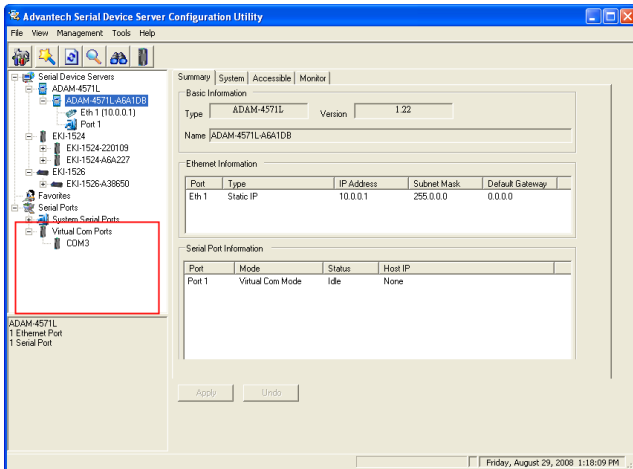

## 4.1.2 Manual Mapping

Right click the serial device name on the sub-tree of Device Server List area and select the “Manual Mapping” function.

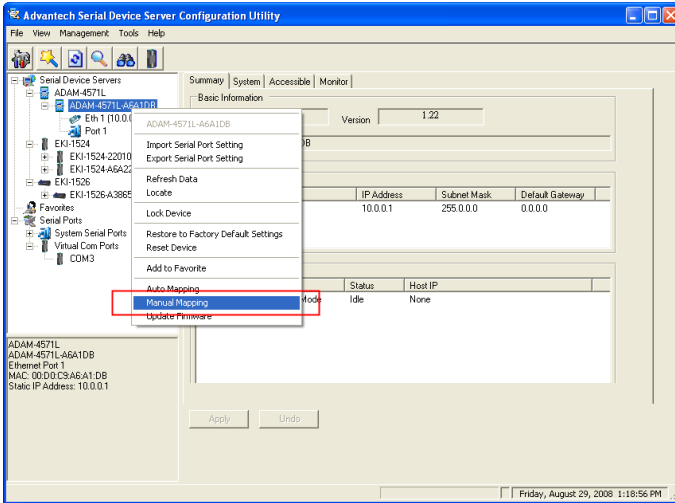

ADAM-4570 series have only one IP address. You select the serial port on the device server and the host COM that you want to set. Press <Map it> to establish the virtual COM port on the host.

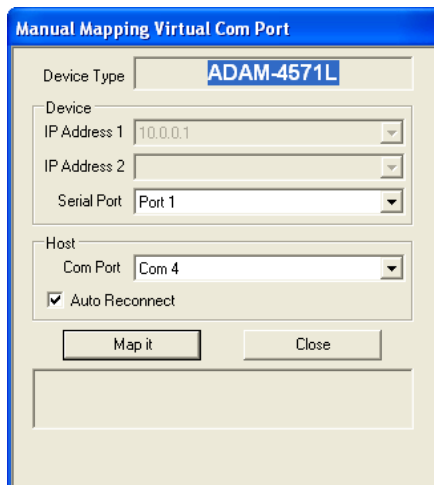

### Auto Reconnect Property:

Sometimes, the connection between Advantech serial device server and HOST is interrupted by network traffic or powered-off by accident. In such a situation, the host has to reconnect to Advantech serial device server. The function "Auto Reconnect" is for this purpose, if the Advantech serial device server loses the connection to its host, the COM redirector will try to re-establish the connection while the host's AP access the virtual COM port. The COM redirector DOES NOT re-establish the connection automatically. When the connection is working again, the host's commands will be automatically received by the Advantech serial device server again. Reconfiguration is not necessary, so this function enhances the reliability of the system.

If the function is disabled, the connection can not be re-established again unless the COM redirector or host is restarted.

*Note If you set the wrong IP address, COM redirector will still try to connect the device. It might cause the system performance low or other issue*

### 4.1.3 Manual Direct Mapping Virtual COM Port

Click the  button on the Quick Took bar, you can add a target by selecting the Device Type and inputting the IP address without physically connecting the serial device server to the network.

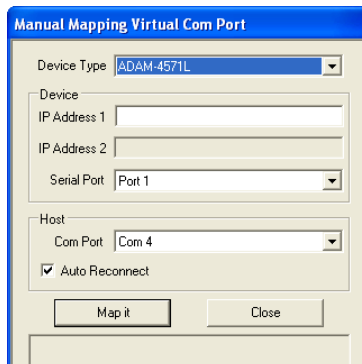

The image shows a dialog box titled "Manual Mapping Virtual Com Port". It contains the following fields and controls:

- Device Type:** A dropdown menu with "ADAM-4571L" selected.
- Device:** A section containing:
  - IP Address 1:** An empty text input field.
  - IP Address 2:** An empty text input field.
  - Serial Port:** A dropdown menu with "Port 1" selected.
- Host:** A section containing:
  - Com Port:** A dropdown menu with "Com 4" selected.
  - Auto Reconnect:** A checked checkbox.
- Buttons:** "Map it" and "Close" buttons at the bottom.

## 4.1.4 Remove the Virtual COM Port

If you want to remove the virtual COM port, you can remove them one by one or group remove ports.

### Individually Remove

Right click on COM port you have mapped before and select “Remove This Port”.

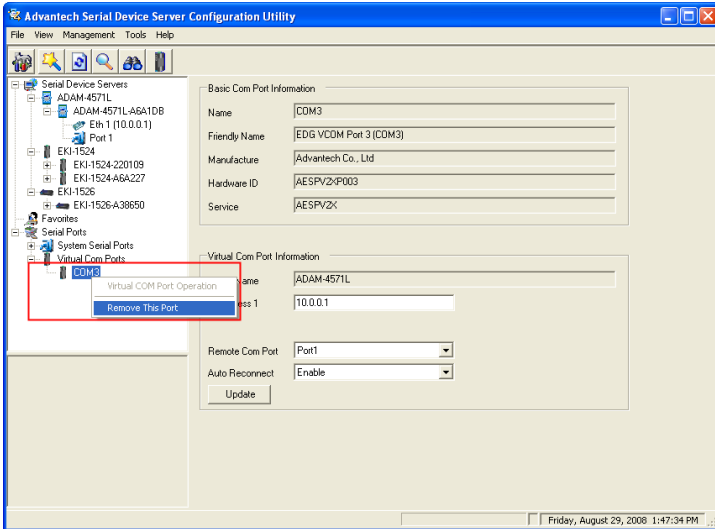

### Group Remove Port

Right click on Virtual Com Ports on Device Server List Area and select “Group Remove Port”, you can choose which ports you want to remove.



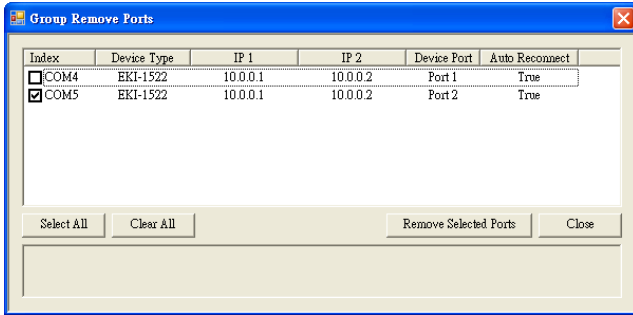

## 4.2 Running Diagnostic Test

---

The purpose of this test is to make sure the communication from host PC to ADAM-4570 series is OK. If there is still an error, you can check the communication from the ADAM-4570 series to the devices.

If the test is selected, an external test will be done to check that the connection signals for each port are working properly. **For the test, you will need to connect each port to a loopback tester (provided in the package). The loopback test only applies to RS-232 mode.** The test is divided into two parts: Signal test and Communication Parameters test.

*Note Before you do this diagnostic test, you must complete the process of virtual COM port mapping (which is described in the next chapter 4.1).*

Click “Simple Serial Test” on the Tools menu.

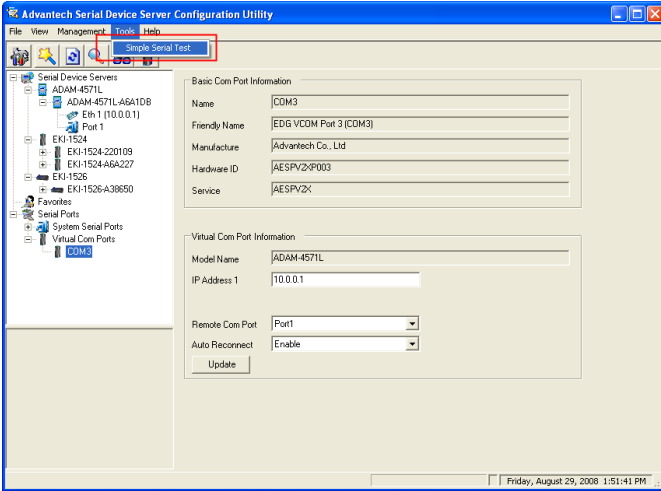

Select which COM port you want to run diagnostic test, and then press “Test” button to process the testing.

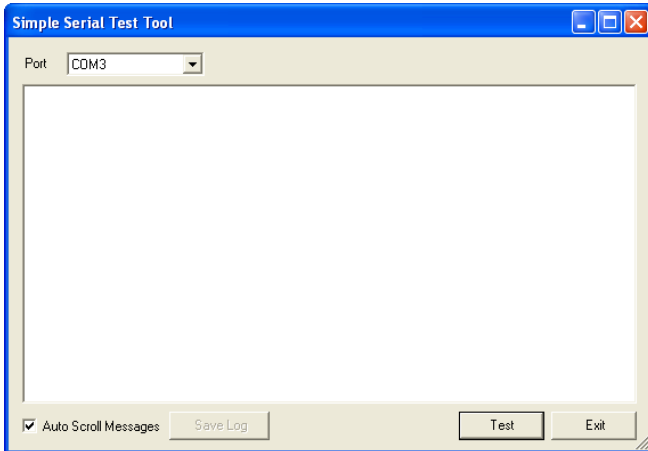

## Signal Test

- RTS -> CTS check the RTS and CTS signal between two ports
- DTR -> RI check the DTR and RI signal between two ports
- DTR -> DSR check the DTR and DSR signal between two ports
- DTR -> DCD check the DTR and DCD signal between two ports

## Communication Parameters Test

- Baud rate: 50bps ~ 921.6kbps
- Data bits: 5, 6, 7, 8
- Stop bit 1, 1.5, 2
- Parity Odd, Even, None, Space, Mark

When the test is finish, it will show the test result, the click “Exit” button to return to the utility window.

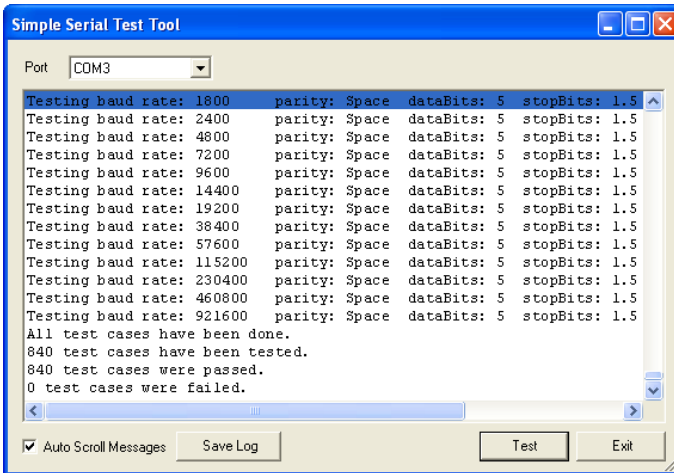



APPENDIX  
**A**

**Pin Assignments**

# Appendix A Pin Assignments

## A.1 RS-232 Pin Assignments

Pin No.	Description
Pin 1	DCD
Pin 2	Rx
Pin 3	Tx
Pin 4	DTR
Pin 5	GND
Pin 6	DSR
Pin 7	RTS
Pin 8	CTS
Pin 9	RI

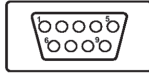

## A.2 RJ-48 Cable PIN Assignment

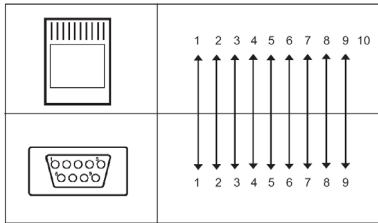

### A.2.1 1. RS-422

Pin No.	Description
1	Tx-
4	Tx+
5	GND
7	Rx+
9	Rx-

### A.2.2 2. RS-485

Pin No.	Description
1	Data-
4	Data+
5	GND

APPENDIX

# B

## Creating VCOM

# Appendix B Creating VCOM

## B.1 Configuration Wizard

### 1. First Step

Click  button on the "Quick Tool Bar" to start the Configuration Wizard; Select the serial device server you want to create the VCOM. (ex. ADAM-4570)

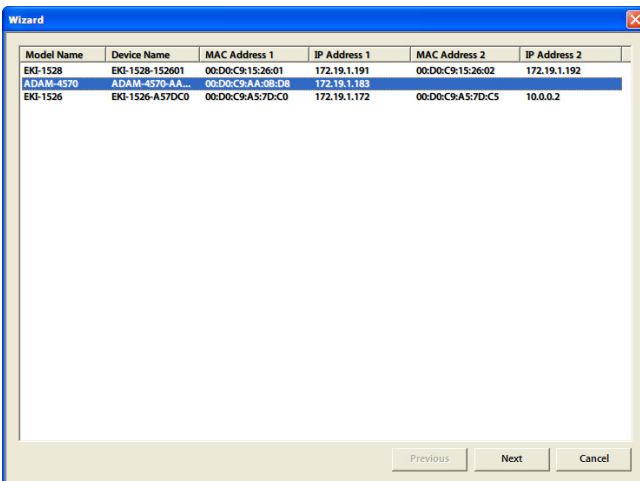
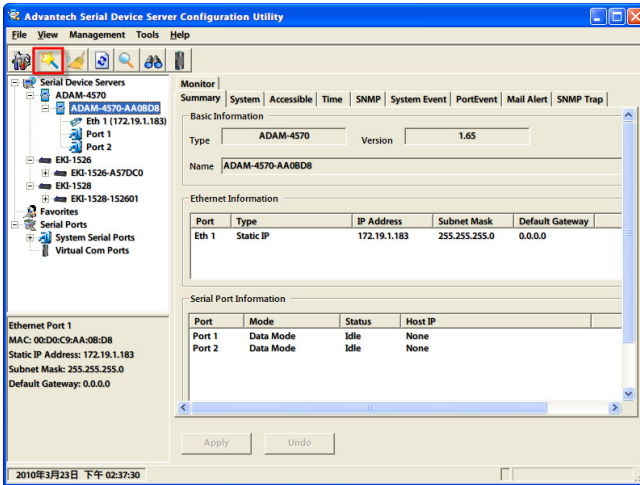



2. Second Step

Fill in options of serial device server including "Serial Type", "IP address", "Subnet Mask", and "Default Gateway".

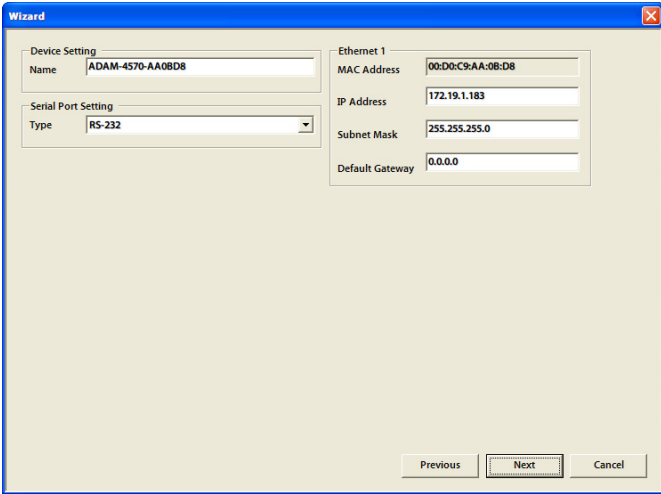

3. Third Step

Choose Port number of start and select to device port you want to create VCOM, then click "Finish" button.

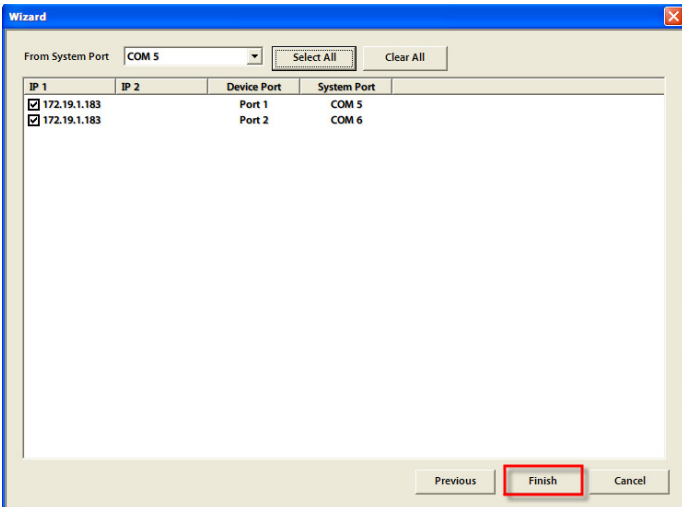

Now, you have two mapped VCOM in your host!

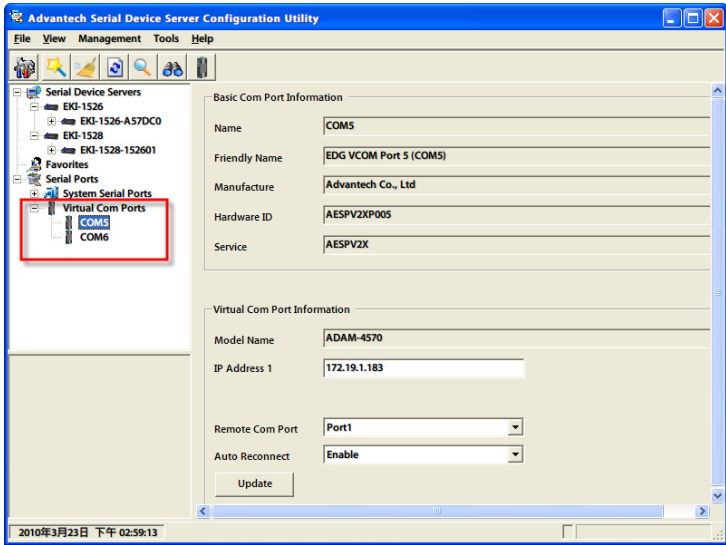



## Стандарт Электрон Связь

Мы молодая и активно развивающаяся компания в области поставок электронных компонентов. Мы поставляем электронные компоненты отечественного и импортного производства напрямую от производителей и с крупнейших складов мира.

Благодаря сотрудничеству с мировыми поставщиками мы осуществляем комплексные и плановые поставки широчайшего спектра электронных компонентов.

Собственная эффективная логистика и склад в обеспечивает надежную поставку продукции в точно указанные сроки по всей России.

Мы осуществляем техническую поддержку нашим клиентам и предпродажную проверку качества продукции. На все поставляемые продукты мы предоставляем гарантию .

Осуществляем поставки продукции под контролем ВП МО РФ на предприятия военно-промышленного комплекса России , а также работаем в рамках 275 ФЗ с открытием отдельных счетов в уполномоченном банке. Система менеджмента качества компании соответствует требованиям ГОСТ ISO 9001.

Минимальные сроки поставки, гибкие цены, неограниченный ассортимент и индивидуальный подход к клиентам являются основой для выстраивания долгосрочного и эффективного сотрудничества с предприятиями радиоэлектронной промышленности, предприятиями ВПК и научно-исследовательскими институтами России.

С нами вы становитесь еще успешнее!

### Наши контакты:

**Телефон:** +7 812 627 14 35

**Электронная почта:** [sales@st-electron.ru](mailto:sales@st-electron.ru)

**Адрес:** 198099, Санкт-Петербург,  
Промышленная ул, дом № 19, литера Н,  
помещение 100-Н Офис 331