

# OsiSense XZ Cabling Accessories

Catalog

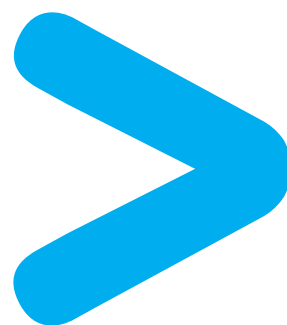







# Sensors with connectors offer a quick, high performance solution

If you need to replace a sensor on a machine, you can do so quickly using products with connectors. Telemecanique Sensors™ brand offers **OsiSense XZ**, a complete range of machine cabling accessories featuring 3 types of cable to suit your environment.

## > PVC cable for general use

The most economical and competitive offer

## > PUR cable for severe industrial environments

The highest performance offer, whatever the conditions

## > Reinforced PVC cable for food and beverage processing environments

The highest degree of protection and most resistant offer

## Contents

Customer benefits .....	4
Selection guide .....	6
Introduction and general specifications .....	10
Pre-wired connectors and jumper cables, PVC cable .....	14
Pre-wired connectors and jumper cables, PUR cable .....	20
Pre-wired connectors and jumper cables, Application series, PVC cable .....	34
Connectors, connector adapters, and splitter boxes .....	38

Simply easy!™ 

## > PVC cable for general use

The OsiSense XZ range of PVC pre-wired connectors and jumper cables for general use is recommended for machines in non-demanding environments and subject to only moderate mechanical stress. These products are particularly suited to assembly, material handling, and packaging machines.

**PVC**  
Economy &  
competitiveness

The sheath color distinguishes the two versions available:

- A gray sheath for versions with metric connectors (M8 and M12)
- A yellow sheath for versions with imperial connectors (1/2" and 7/8").



### The + of the PVC range

#### Good resistance

- to moderate mechanical stress
- to chemical products
- to humid environments

#### Easy cable stripping

UL certified



## > PUR cable for severe industrial environments

The OsiSense XZ range of very high performance PUR (polyurethane) pre-cabled connectors and jumper cables is designed for the most demanding industrial requirements. This offer is ideal for machines using lubricants, cooling oils, and grease, and where cables are subject to severe mechanical stress from flexing and friction. These cables are ideal for the automotive, machine tool, and hydraulic machine sectors. Their excellent flexibility permits intensive use for alternating movements such as those associated with cable carriers, robotics, turntables, and the like. The cables are halogen free, UL certified and have high degrees of protection (IP67 and IP69K).

halogen  
**free**

**4 million**  
alternating  
flexing  
operations



### The + of the PUR range

#### Good resistance

- to severe mechanical stress (friction, abrasion, torsion)
- to hot and cold oils, greases and lubricants

#### Halogen free

UL certified



# > Reinforced PVC cable for food and beverage processing environments

The OsiSense XZ range of reinforced PVC pre-cabled connectors and jumper cables is specifically designed for the food and beverage processing industry. Featuring hygienically designed 316L stainless steel connectors with smooth clamping ring, these products are designed to withstand high pressure washing and disinfection using aggressive detergents.

**IP69K**  
&  
**316L**  
stainless steel  
for corrosion  
resistance



the + of the PVC food and beverage range

#### Good resistance

- to high pressure cleaning (IP69K and smooth stainless-steel clamping ring)
- to disinfection using aggressive detergents



## Accessories

The OsiSense XZ range also includes a complete range of connectors and splitter boxes compatible with the pre-wired connectors and jumper cables.



**100+**

Available in more than 100 countries worldwide

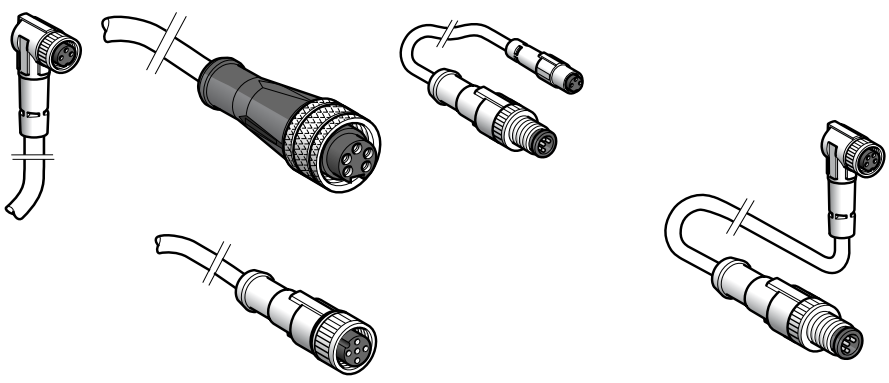
Description		Pre-wired connectors					Jumper cables (female–male)							
														
Type	Female	●	●	●	●						● (DIN) (1)			
	Male	●	●	–	–	● (M8)	● (M12)	● (M8)	● (M12)					
Connection	Clip	●	–											
	Screw threaded	●												
Model	Straight	●												
	Elbowed	●	● (2)	●	–									
Number of pins		3	4	3	4	5	3			5	3	4	5	3
	Signaling	●	–	●										
	Without LED	●	–	●										
	With LED	●	–	●	–									
Nominal voltage	~ 10...30 V (with LED)	●	–	●	–									
	~ 30, ~ 36 V	–				●	–				●	–	●	
	~ 60, ~ 75 V	●												
	~ 125, ~ 150 V	–												
	~ 250, ~ 300 V	–	●	–	●	–				●	–			
	~ 250 V	–					●							
Current (A)		3 or 4			6		4 or 6		4					
Cable length	0.5 m (1.6 ft)	●	–	● (3)	–									
	1 m (3.3 ft)	●	–	● (3)	–									
	2 m (6.6 ft)	●												
	5 m (16.4 ft)	●				● (2)	●							
	10 m (32.8 ft)	●				● (2)	●							
Reference		<b>XZCP</b>					<b>XZCR</b>							
Pages		page 14 (PVC cable) page 20 (PUR cable)					page 18 (PVC cable) page 26 (PUR cable)							

(1) EN 175301-803-A (ex-DIN 43650).  
 (2) For female pre-wired connectors.  
 (3) For male pre-wired connectors.

● Available.  
 – Not available.

**Pre-wired connectors: Application series**

PVC cable, stainless steel clamping ring, and IP69K degree of protection

**Jumper cables (female–male): Application series**

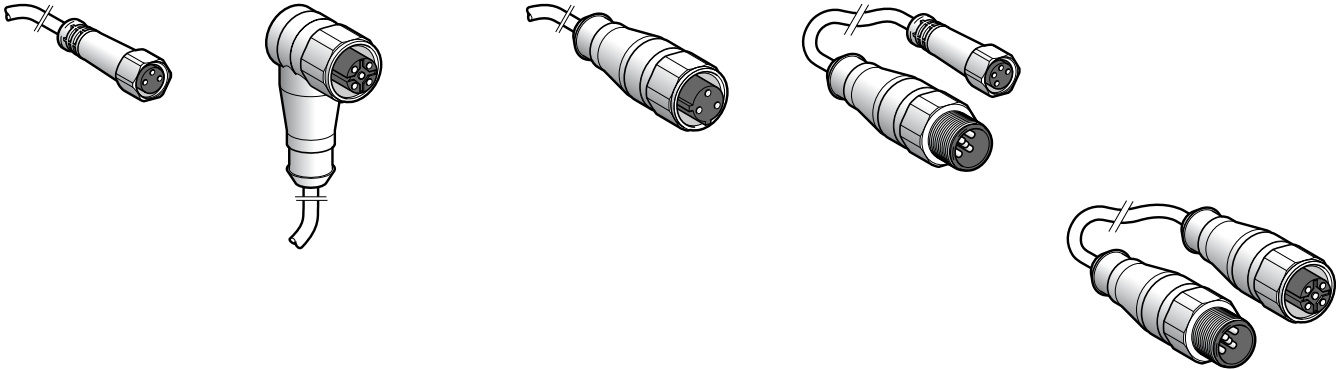

M8	M12	1/2"-20UNF
•	•	•
–	–	–

–	–	–
• (hand-tightening recommended)		
•	•	•
–	–	–
3	4	4
4	5	3
•	•	•
–	–	–

–	–	–
–	–	–
•	–	–
–	–	–
–	•	–
–	–	–
4	–	–
–	–	–
–	–	–
–	•	–
•	–	–
•	–	–

M8–M12	M12–M12
• (M8)	• (M12)
• (M12)	• (M12)

–	–
• (hand-tightening recommended)	
•	•
–	–
4	3
–	4
•	5
–	–

–	–
–	–
•	–
–	–
–	•
–	–
4	–
–	–
–	–
•	–
•	–
–	–

**XZCPA**

page 34

**XZCRA**

page 36

• Available.  
– Not available.

**Description**

**Connectors**

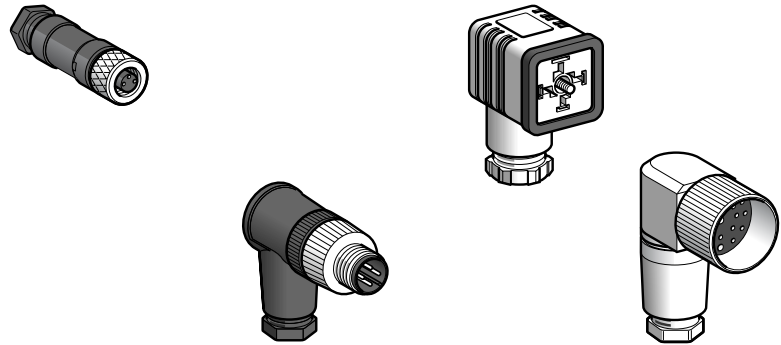

<b>Type</b>	Female
	Male

M8	M12	1/2"-20UNF	M18	EN 175301-803-A (ex-DIN 43650)	M23
•					
•			–		•

<b>Connection</b>	Clip
	Screw threaded

–					
•					

<b>Model</b>	Straight
	Elbowed

•				–	•
•					

<b>Number of pins</b>	
-----------------------	--

3	4	5	3	4	19
---	---	---	---	---	----

<b>Signaling</b>	Without LED
	With LED

•					
–	•	–			

<b>Nominal voltage</b>	≡ 10...30 V (with LED)
	~ 30, ≡ 36 V
	~ 60, ≡ 75 V
	~ 125, ≡ 150 V
	~ 250, ≡ 300 V
	~ 250 V

–	•	–			
–		•	–		
•	–				•
–	•	–			
–			•		–

<b>Current (A)</b>	
--------------------	--

4	3	4	16	7.5
---	---	---	----	-----

<b>Cable length</b>	0.5 m (1.6 ft)
	1 m (3.3 ft)
	2 m (6.6 ft)
	5 m (16.4 ft)
	10 m (32.8)

–					
–					
–					
–					
–					

**Reference**

**XZCC**

**Pages**

page 38

• Available.  
– Not available.



**Connector adapters**

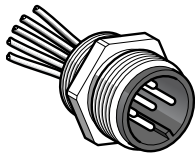
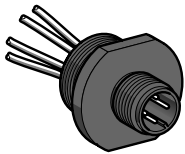

**Passive splitter boxes (1)**

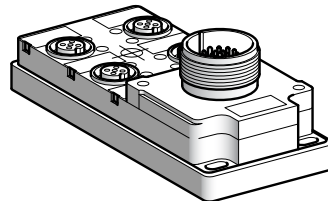

M12	7/8"-16UN	4 or 8 channel
-		● (M12)
●		-
-		-
●		-
●		●
-		-
4	5	19
●		●
-		●
-		≡ 24 V
-	●	-
-		-
-		-
●	-	●
-		-
4	6	4 per channel
Length of wires: 0.10 m (3.9 in.)		-
		-
		-
		-
		●
		●

**XZCE**

page 48

**ABE9**

page 50

(1) For other splitter boxes, refer to the website, [www.schneider-electric.com](http://www.schneider-electric.com).

- Available.
- Not available.

**Other versions**

Consult the Customer Care Center.

# OsiSense™ XZ

## Machine cabling accessories

Cabling systems

### Introduction

To meet the requirements of different application sectors, Telemecanique™ Sensors offer a full range of connection accessories.

In particular, the pre-wired connectors and jumper cables have been adapted for use with the OsiSense sensors. These accessories must withstand the same electrical and mechanical stresses and, above all, the same environmental conditions.

The accessories can be divided into three broad categories:

#### PVC cables: OsiSense XZCPV and XZCRV

- Areas of application:
  - Regular use in packaging and conveying
  - Assembly lines in the paper and card industry
  - Small machines
  - Moderate mechanical stress
- Main specifications:
  - Very good value for money
  - Good water resistance
  - Good frictional resistance
  - Permanent contact with oil and grease must be avoided



PVC cables: OsiSense XZCPV and XZCRV

#### PVC cables with reinforced connectors: OsiSense XZCPA and XZCRA

- Areas of application:
  - Specially developed for the food and beverage sector
- Main specifications:
  - Enhanced protection: IP68/IP69K
  - Very good water resistance
  - Impervious to detergents, disinfectants, and chemicals
  - Tolerant of moderate mechanical stress



PVC cables with reinforced connector: OsiSense XZCPA and XZCRA

#### PUR cables: OsiSense XZCP and XZCR

- Recommended for all industrial applications:
  - Automotive
  - Machine tools
  - Handling
  - Cable carrier
  - Robotics sectors
- Main specifications:
  - High mechanical and chemical performance
  - Good resistance to oil, grease, and coolants
  - Good bending strength and abrasion resistance
  - Good UV resistance



PUR cables: OsiSense XZCP and XZCR



OsiSense XZCC connectors



OsiSense XZCE connector adapters

For cabling kits, Telemecanique sensors offer:

- OsiSense XZCC connectors (screwed, insulation displacement, or soldered)
- OsiSense XZCE connector receptacles, for control panels (for enclosures, junction boxes, etc.)

### Cabling accessories

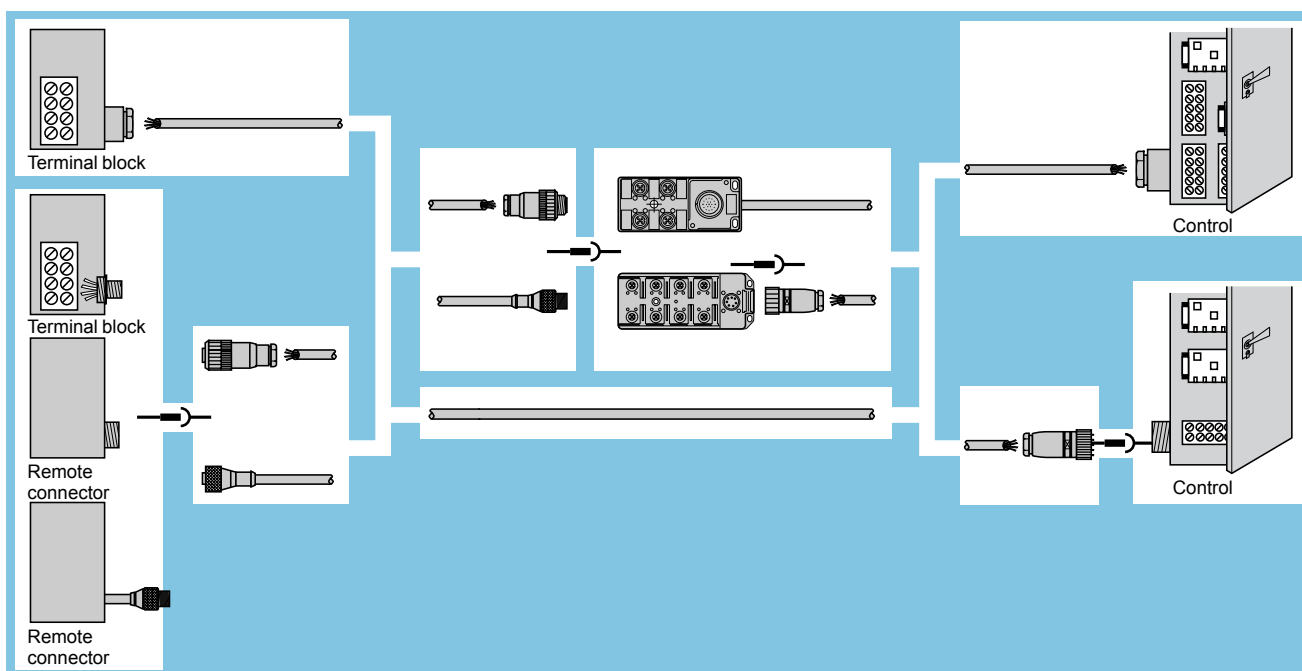
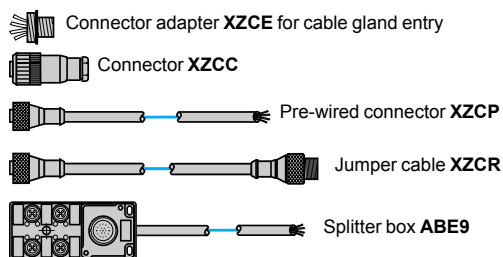

### Connection example

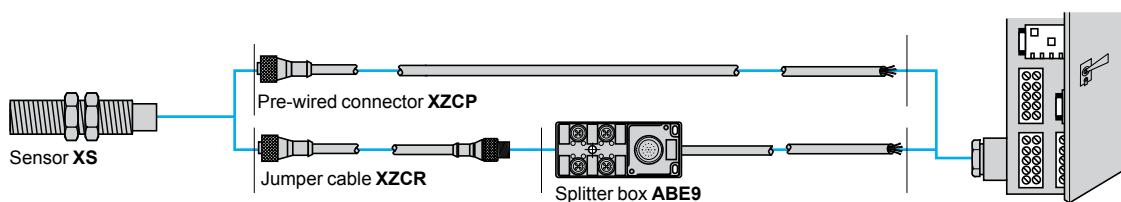

# OsiSense™ XZ

## Machine cabling accessories

Cabling systems

Specifications			
Type of cable		High-performance cables XZCP and XZCR See pages 13 to 33	General use cables XZCPV and XZCRV See pages 13 to 19
<b>Ambient air temperature</b>			
	For operation	°C (°F) -35 to +90 (-31 to +194)	-25 to +80 (-13 to +176)
	For storage	°C (°F) -55 to +100 (-67 to +212)	-55 to +80 (-67 to +176)
<b>Color</b>		Matte black	Gray
<b>Material</b>	Sheath	PUR/PVC	PVC
	Conductor insulation	PVC	PVC
<b>Manufacturing method</b>		Without silicone and without demolding agent	Without silicone and without demolding agent
<b>Nominal voltage</b>		<b>V</b> 320, conforming to DIN VDE 0110 (III/3)	~ 250 V, ≡ 300 V
<b>Insulation voltage</b>		<b>kV</b> 2.5	2.5
<b>Flame resistance</b>		C2 conforming to NF C 32-070	VW-1 conforming to UL758
<b>Environmental resistance</b>		Resistant to soluble, mineral, or synthetic oils at 194 °F (90 °C)	Conditions of use where not continuously immersed
<b>Bending radius</b>		Dynamic: 15 x external diameter Static: 10 x external diameter	Static: 10 x external diameter
<b>Tensile strength</b>		<b>N/mm<sup>2</sup></b> 20 to 45	10
<b>Hardness</b>		80 ±5 Shore A	70 ±5 Shore A



# OsiSense™ XZ

## Machine cabling accessories

Cabling systems

Application series cable with reinforced insulation XZCPA and XZCRA See pages 34 to 37	Bare cable XZCB4L0●● See page 49
-25 to +95 (-13 to +203)	-35 to +90 (-31 to +194)
-25 to +95 (-13 to +203)	-40 to +100 (-40 to +212)
Matte black	Matte black
PVC	PvR (PVC/NBR)
PVC	PVC
Without silicone and without demolding agent	Without silicone and without demolding agent
~ 250 V, --- 300 V	300
3	2, conforming to NFC 32-201-1
C2 conforming to NF C 32-070	C2 conforming to NF C 32-070
Resistant to solvents and detergents	Resistant to soluble, mineral, or synthetic oils at 194 °F (90 °C)
Static: 10 x external diameter	R min. = 3 x external diameter
11	10 to 35
80 ±5 Shore A	70 ±5 Shore A

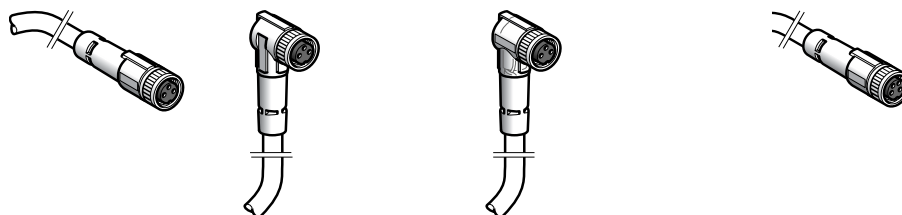

Connector type	Female, M8, straight	Female, M8, elbowed	Female, M8, elbowed with PNP LED	Female, M8, straight
Number of pins	3	3	3	4
<b>Catalog numbers</b>				
PVC cable	1 m (3.3 ft)	–	–	–
	2 m (6.6 ft)	<b>XZCPV0566L2</b>	<b>XZCPV0666L2</b>	<b>XZCPV0766L2</b>
	5 m (16.4 ft)	<b>XZCPV0566L5</b>	<b>XZCPV0666L5</b>	<b>XZCPV0766L5</b>
	10 m (32.8 ft)	<b>XZCPV0566L10</b>	<b>XZCPV0666L10</b>	<b>XZCPV0766L10</b>
Weight, kg (lb)	2 m (6.6 ft)	0.084 (0.19)	0.084 (0.19)	0.090 (0.20)
	5 m (16.4 ft)	0.153 (0.34)	0.153 (0.34)	0.180 (0.40)
	10 m (32.8 ft)	0.316 (0.70)	0.316 (0.70)	0.360 (0.79)

<b>Specifications</b>			
Certifications		cULus	cULus
Connection type		Screw threaded (metal clamping ring)	Screw threaded (metal clamping ring)
Degree of protection		IP65	IP65
Ambient temperature	Static	–25 to +80 °C (–13 to +176 °F)	–25 to +80 °C (–13 to +176 °F)
Cabling		Ø4.6 mm cable conductor c.s.a.: 3 x 0.25 mm <sup>2</sup>	Ø4.6 mm cable / conductor c.s.a.: 3 x 0.25 mm <sup>2</sup> / Ø4.6 mm cable / conductor c.s.a.: 4 x 0.25 mm <sup>2</sup>
LED indicators		–	2 PNP LEDs
Nominal voltage		~ 60 V, ~ 75 V	~ 10 to 30 V / ~ 60 V, ~ 75 V
Nominal current		3 A	3 A
Nominal tightening torque		0.2 N•m (1.77 lb-in)	0.2 N•m (1.77 lb-in)
Insulation resistance		> 10 <sup>9</sup> Ω	> 10 <sup>9</sup> Ω
Contact resistance		≤ 5 mΩ	≤ 5 mΩ

### Dimensions

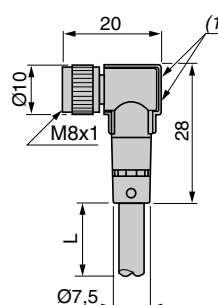
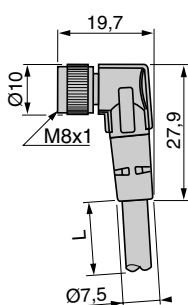
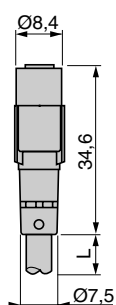

(1) 2 LEDs.  
Cable: 2, 5, or 10 m (6.6, 16.4, or 32.8 ft).

### Connections

LED connection	Connector	
<b>XZCPV0766L</b>	<b>XZCPV0666L</b>	<b>XZCPV0941L</b>

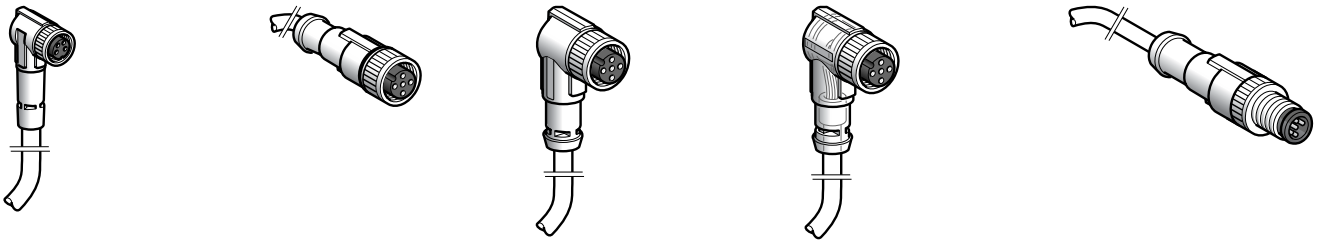

Female, M8, elbowed	Female, M12, straight	Female, M12, elbowed	Female, M12, elbowed with PNP LED	Male, M12, straight
4	4	4	3	4
-	-	-	-	<b>XZCPV1541L1</b>
<b>XZCPV1041L2</b>	<b>XZCPV1141L2</b>	<b>XZCPV1241L2</b>	<b>XZCPV1340L2</b>	<b>XZCPV1541L2</b>
<b>XZCPV1041L5</b>	<b>XZCPV1141L5</b>	<b>XZCPV1241L5</b>	<b>XZCPV1340L5</b>	<b>XZCPV1541L5</b>
<b>XZCPV1041L10</b>	<b>XZCPV1141L10</b>	<b>XZCPV1241L10</b>	<b>XZCPV1340L10</b>	-
0.100 (0.22)	0.110 (0.24)	0.110 (0.24)	0.110 (0.24)	0.5 m (1.6 ft) = 0.052 (0.11)
0.200 (0.44)	0.210 (0.46)	0.210 (0.46)	0.210 (0.46)	1 m (3.3 ft) = 0.090 (0.20)
0.380 (0.84)	0.390 (0.86)	0.390 (0.86)	0.390 (0.86)	2 m (6.6 ft) = 0.200 (0.44)

cULus

Screw threaded (metal clamping ring)

IP65

-25 to +80 °C (-13 to +176 °F)

Ø4.6 mm cable conductor c.s.a.: 4 x 0.25 mm <sup>2</sup>	Ø4.6 mm cable conductor c.s.a.: 4 x 0.25 mm <sup>2</sup>	Ø4.6 mm cable conductor c.s.a.: 4 x 0.25 mm <sup>2</sup>	Ø4.6 mm cable conductor c.s.a.: 3 x 0.25 mm <sup>2</sup>	Ø4.6 mm cable conductor c.s.a.: 4 x 0.25 mm <sup>2</sup>
-	-	-	2 PNP LEDs	-
~ 60 V, --- 75 V	~ 250 V, --- 300 V	~ 250 V, --- 300 V	--- 10 to 30 V	~ 250 V, --- 300 V
3 A	3 A	3 A	3 A	3 A
0.2 N•m (1.77 lb-in)	0.4 N•m (3.54 lb-in)	0.4 N•m (3.54 lb-in)	0.4 N•m (3.54 lb-in)	0.4 N•m (3.54 lb-in)
> 10 <sup>9</sup> Ω	> 10 <sup>9</sup> Ω	> 10 <sup>9</sup> Ω	> 10 <sup>9</sup> Ω	> 10 <sup>9</sup> Ω
≤ 5 mΩ	≤ 5 mΩ	≤ 5 mΩ	≤ 5 mΩ	≤ 5 mΩ

**XZCPV1041L●**

**XZCPV1141L●**

**XZCPV1241L●**

**XZCPV13040L●**

**XZCPV1541L●**

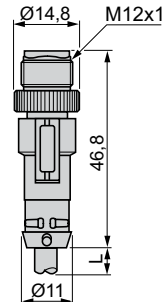
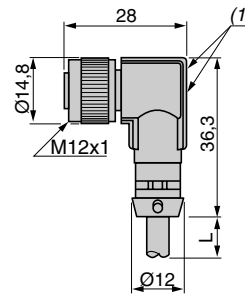
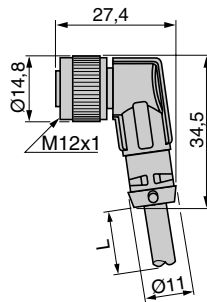
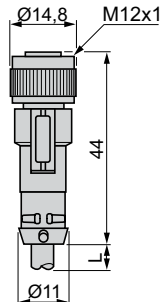
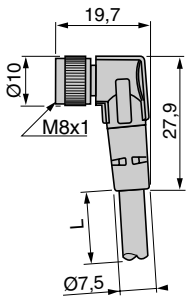

(1) 2 LEDs.

Cable: 2, 5, or 10 m (6.6, 16.4, or 32.8 ft).

1, 2, or 5 m (3.3, 6.6, or 16.4 ft).

**LED connection**

**Connectors**

**XZCPV1340L●**

**XZCPV1041L●**

**XZCPV1141L● and XZCPV1241L●**

**XZCPV13040L●**

**XZCPV1541L●**

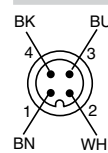
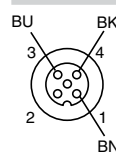
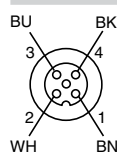
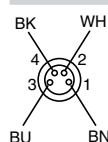
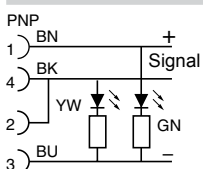

# OsiSense™ XZ Machine cabling accessories

Pre-wired connectors, M8, M12, 1/2"-20UNF and 7/8"-16UN  
PVC cable

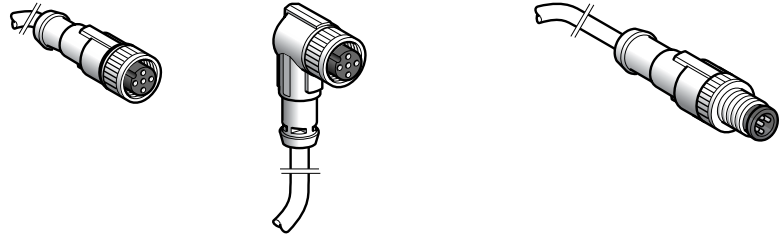

Connector type	Female, M12, straight	Female, M12, elbowed	Male, M12, straight
Number of pins	5	5	5

## Catalog numbers

PVC cable	1 m (3.3 ft)	2 m (6.6 ft)	5 m (16.4 ft)	10 m (32.8 ft)	XZCPV1564L1	XZCPV1264L2	XZCPV1564L2	XZCPV1564L5
	–	<b>XZCPV1164L2</b>	<b>XZCPV1164L5</b>	<b>XZCPV1164L10</b>	–	<b>XZCPV1264L2</b>	<b>XZCPV1264L5</b>	<b>XZCPV1564L5</b>
Weight, kg (lb)	1 m (3.3 ft)	–	–	–	–	–	–	–
	2 m (6.6 ft)	0.100 (0.22)	0.100 (0.22)	0.100 (0.22)	0.075 (0.17)	0.100 (0.22)	0.100 (0.22)	0.100 (0.22)
	5 m (16.4 ft)	0.180 (0.40)	0.180 (0.40)	0.180 (0.40)	0.180 (0.40)	0.180 (0.40)	0.180 (0.40)	0.180 (0.40)
	10 m (32.8 ft)	0.360 (0.79)	0.360 (0.79)	0.360 (0.79)	–	0.360 (0.79)	–	–

## Specifications

Certifications	UL
Connection type	Screw threaded (metal clamping ring)
Cable material	PVC, gray
Degree of protection	IP65, IP67
Ambient air temperature	Static cable
Cabling	–25 to +80 °C (–13 to +176 °F)
Nominal voltage	~ 250 V, --- 300 V
Nominal current	3 A
Nominal tightening torque	0.4 N·m (3.54 lb-in)
Insulation resistance	> 10 <sup>9</sup> Ω
Contact resistance	≤ 5 m Ω

## Dimensions

### XZCPV1164L●

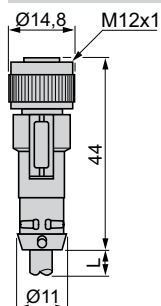

### XZCPV1264L●

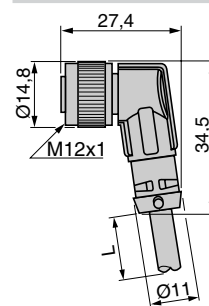

### XZCPV1564L●

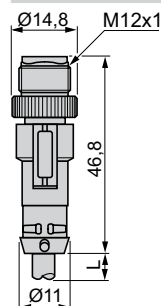

Cable: 1, 2, 5, or 10 m (3.3, 6.6, 16.4, or 32.8 ft).

## Connections

### Connectors

#### XZCPV1164L● and XZCPV1264L●

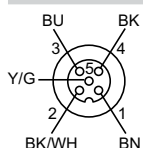

#### XZCPV1564L●

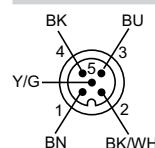



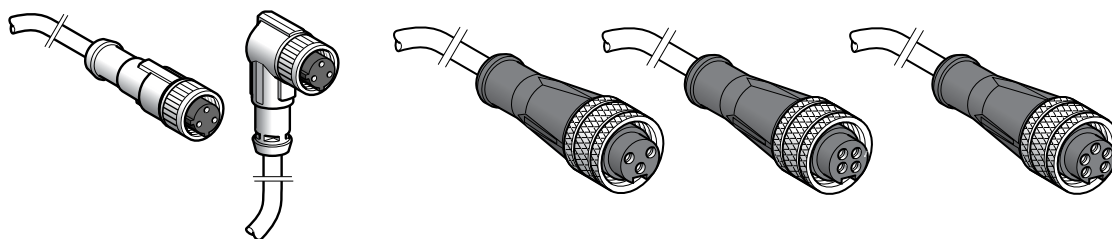

Connector type	Female, 1/2"-20UNF, straight	Female, 1/2"-20UNF, elbowed	Female, 7/8"-16UN, straight	Female, 7/8"-16UN, straight	Female, 7/8"-16UN, straight
Number of pins	3	3	3	4	5

### Catalog numbers

PVC cable	2 m (6.6 ft)	<b>XZCPV1865L2</b>	<b>XZCPV1965L2</b>	<b>XZCPV1670L2</b>	<b>XZCPY4275L2 ▲</b>	<b>XZCPY1764L2 ▲</b>
	5 m (16.4 ft)	<b>XZCPV1865L5</b>	<b>XZCPV1965L5</b>	<b>XZCPV1670L5</b>	<b>XZCPY4275L5 ▲</b>	<b>XZCPY1764L5 ▲</b>
	10 m (32.8 ft)	<b>XZCPV1865L10</b>	<b>XZCPV1965L10</b>	<b>XZCPV1670L10</b>	<b>XZCPY4275L10 ▲</b>	<b>XZCPY1764L10 ▲</b>
Weight, kg (lb)	2 m (6.6 ft)	0.140 (0.31)	0.140 (0.31)	0.300 (0.66)	–	–
	5 m (16.4 ft)	0.350 (0.77)	0.350 (0.77)	0.500 (1.10)	–	–
	10 m (32.8 ft)	0.700 (1.54)	0.700 (1.54)	0.850 (1.87)	–	–
	1.8 m (6 ft)	–	–	–	0.340 (0.75)	0.400 (0.88)
	4.6 m (15 ft)	–	–	–	0.850 (1.87)	1.000 (2.20)
	9.2 m (30 ft)	–	–	–	1.700 (3.75)	1.900 (4.19)

### Specifications

Certifications	UL	–	–	–
Connection type	Screw threaded (metal clamping ring)		Screw threaded (metal clamping ring)	
Cable material	PVC, yellow		PVC, yellow	PVC, yellow, STOOW
Degree of protection	IP65, IP67		IP67	
Ambient air temperature	Static cable	–25 to +80 °C (–13 to +176 °F)		–25 to +80 °C (–13 to +176 °F)
Cabling	Ø4.6 mm cable, conductor c.s.a.: 3 x 0.34 mm <sup>2</sup>		Ø5.2 mm cable, conductor c.s.a.: 3 x 0.75 mm <sup>2</sup>	Ø10.8 mm cable, conductor c.s.a.: 4 x 1.5 mm <sup>2</sup> (16 AWG)
Nominal voltage	~ 250 V, ~ 300 V		~ 250 V, ~ 300 V	~ 600 V
Nominal current	4 A		7 A	10 A
Nominal tightening torque	0.4 N•m (3.54 lb-in)		0.8 N•m (7.08 lb-in)	0.8 N•m (7.08 lb-in)
Insulation resistance	> 10 <sup>9</sup> Ω		> 10 <sup>9</sup> Ω	> 10 <sup>9</sup> Ω
Contact resistance	≤ 5 m Ω		≤ 5 m Ω	≤ 5 m Ω

### Dimensions

XZCPV1865L●	XZCPV1965L●	XZCPV1670L●	XZCPY4275L● and XZCPY1764L●

(1) 1/2"-20UNF. Cable: 2, 5, or 10 m (6.6, 16.4, or 32.8 ft).

▲: Available 2<sup>nd</sup> half 2012.

### Connections

XZCPV1865L● and XZCPV1965L●	XZCPV1670L●	XZCPY4275L●	XZCPY1764L●

# OsiSense™ XZ Machine cabling accessories

Pre-wired connectors, M12  
PVC cable

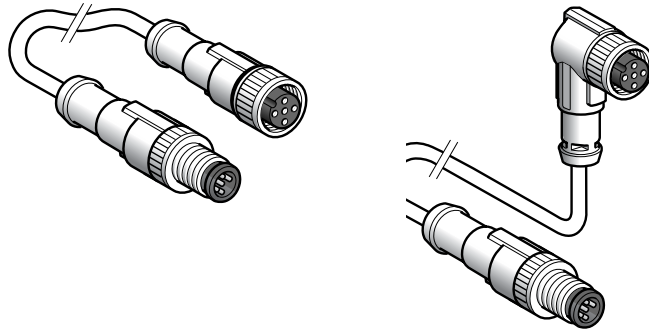

<b>Male connector type</b>	M12, 3-pin, straight		
<b>Female connector type</b>	M12, 3-pin, straight	M12, 3-pin, elbowed	
<b>Number of conductors</b>	3		3
<b>Catalog numbers</b>			
<b>PVC cable</b>	1 m (3.3 ft)	<b>XZCRV1511040A1</b>	<b>XZCRV1512040A1</b>
	2 m (6.6 ft)	<b>XZCRV1511040A2</b>	<b>XZCRV1512040A2</b>
<b>Weight, kg (lb)</b>	1 m (3.3 ft)	0.064 (0.14)	0.068 (0.15)
	2 m (6.6 ft)	0.099 (0.22)	0.100 (0.22)

<b>Specifications</b>	
<b>Certifications</b>	UL pending
<b>Connection type</b>	Male and female: screw threaded (metal clamping ring)
<b>Degree of protection</b>	IP65
<b>Ambient temperature</b>	Static
<b>Cabling</b>	Ø4.6 mm cable conductor c.s.a.: 3 x 0.25 mm <sup>2</sup>
<b>Nominal voltage</b>	~ 250 V, ~ 300 V
<b>Nominal current</b>	3 A
<b>Nominal tightening torque</b>	0.4 N·m (3.54 lb-in)
<b>Insulation resistance</b>	> 10 <sup>9</sup> Ω
<b>Contact resistance</b>	≤ 5 mΩ

## Dimensions

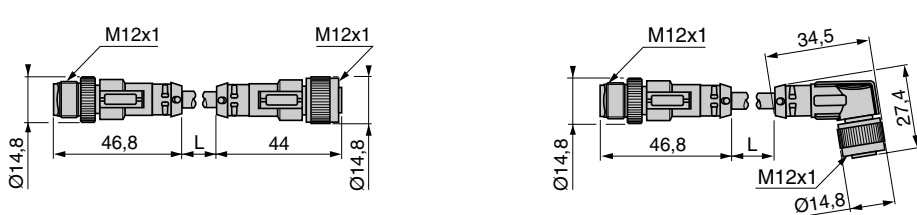

Cable: 1 or 2 m (3.3 or 6.6 ft).

## Connections

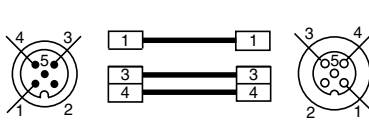

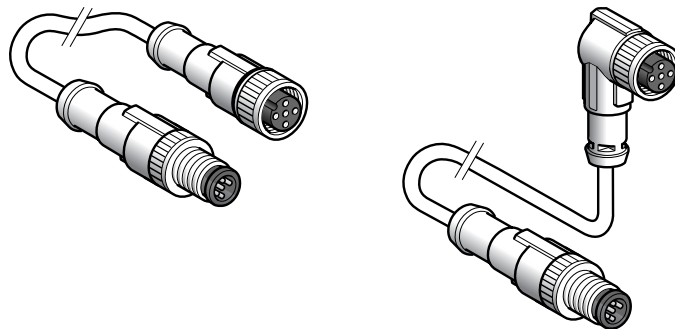

Male connector type	M12, 4-pin, straight	
Female connector type	M12, 4-pin, straight	M12, 4-pin, elbowed
Number of conductors	4	

### Catalog numbers

PVC cable	1 m (3.3 ft)	<b>XZCRV1511041C1</b>	<b>XZCRV1512041C1</b>
	2 m (6.6 ft)	<b>XZCRV1511041C2</b>	<b>XZCRV1512041C2</b>
	5 m (16.4 ft)	<b>XZCRV1511041C5</b>	<b>XZCRV1512041C5</b>
Weight, kg (lb)	1 m (3.3 ft)	0.064 (0.14)	0.067 (0.15)
	2 m (6.6 ft)	0.109 (0.24)	0.106 (0.23)
	5 m (16.4 ft)	0.140 (0.31)	0.230 (0.51)

### Specifications

Certifications	UL pending
Connection type	Male and female: screw threaded (metal clamping ring)
Degree of protection	IP65
Ambient temperature	Static
Cabling	-25 to +80 °C (-13 to +176 °F)
Nominal voltage	Ø4.6 mm cable
Nominal current	conductor c.s.a.: 4 x 0.25 mm <sup>2</sup>
Nominal tightening torque	~ 250 V, ~ 300 V
Insulation resistance	3 A
Contact resistance	0.4 N·m (3.54 lb-in)
	> 10 <sup>9</sup> Ω
	≤ 5 mΩ

### Dimensions

XZCRV1511041C●

XZCRV1512041C●

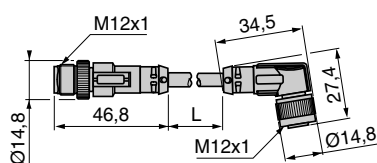
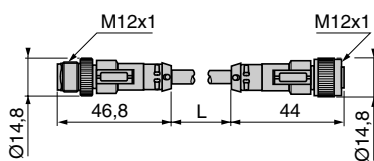

Cable: 1 or 2 m (3.3 or 6.6 ft).

### Connections

XZCRV1511041C● and XZCRV1512041C●

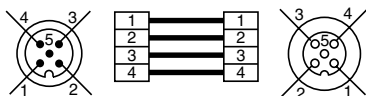

# OsiSense™ XZ Machine cabling accessories

Pre-wired connectors, Ø8 mm and M8  
PUR cable

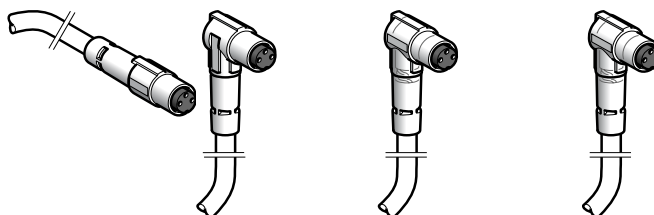

<b>Connector type</b>		Female, Ø8 mm, straight	Female, Ø8 mm, elbowed	Female, Ø8 mm, elbowed with PNP LED	Female, Ø8 mm, elbowed with NPN LED
<b>Number of pins</b>		3			
<b>Catalog numbers</b>					
<b>PUR cable</b> (see page 12)	2 m (6.6 ft)	<b>XZCP0166L2</b>	<b>XZCP0266L2</b>	<b>XZCP0366L2</b>	<b>XZCP0466L2</b>
	5 m (16.4 ft)	<b>XZCP0166L5</b>	<b>XZCP0266L5</b>	<b>XZCP0366L5</b>	<b>XZCP0466L5</b>
	10 m (32.8 ft)	<b>XZCP0166L10</b>	<b>XZCP0266L10</b>	<b>XZCP0366L10</b>	<b>XZCP0466L10</b>
<b>Weight</b>	2 m (6.6 ft)	0.050 (0.11)			
	5 m (16.4 ft)	0.110 (0.24)			
	10 m (32.8 ft)	0.215 (0.47)			

<b>Specifications</b>					
<b>Certifications</b>	cULus				
<b>Connection type</b>	Clip (clip-together connectors, without clamping ring)			Clip (clip-together connectors, without clamping ring)	
<b>Degree of protection</b>	IP67 (when correctly clipped together)			IP65 (when correctly clipped together)	
<b>Ambient air temperature</b>	Static cable	-35 to +90 °C (-31 to +194 °F)			-35 to +90 °C (-31 to +194 °F)
	Flexing cable	-5 to +90 °C (23 to +194 °F)			-5 to +90 °C (23 to +194 °F)
<b>Cabling</b>	Ø5.2 mm cable, conductor c.s.a.: 3 x 0.34 mm <sup>2</sup>			Ø5.2 mm cable, conductor c.s.a.: 3 x 0.34 mm <sup>2</sup>	
<b>LED indicators</b>	-			2 PNP LEDs	2 NPN LEDs
<b>Nominal voltage</b>	~ 60 V, --- 75 V			--- 10 to 30 V	
<b>Nominal current</b>	4 A			4 A	
<b>Insulation resistance</b>	> 10 <sup>9</sup> Ω			> 10 <sup>9</sup> Ω	
<b>Contact resistance</b>	≤ 5 mΩ			≤ 5 mΩ	

## Dimensions

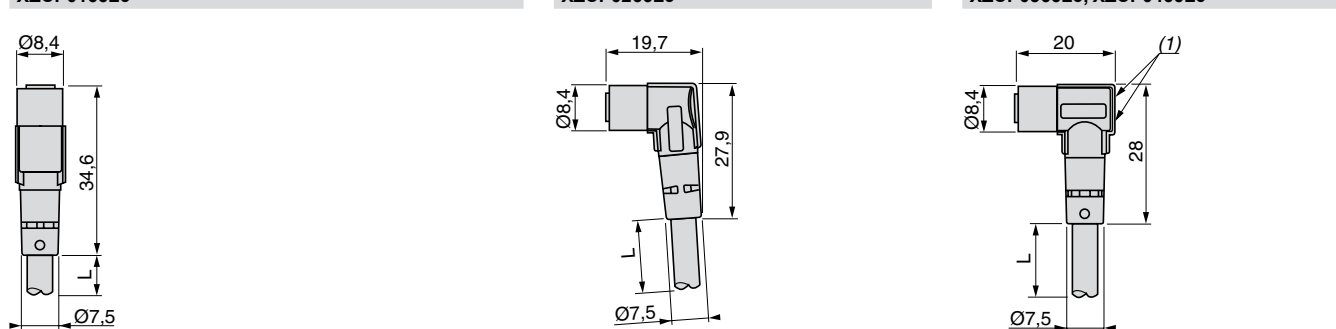

(1) 2 LEDs.  
Cable: 2, 5, or 10 m (6.6, 16.4, or 32.8 ft).

## Connections

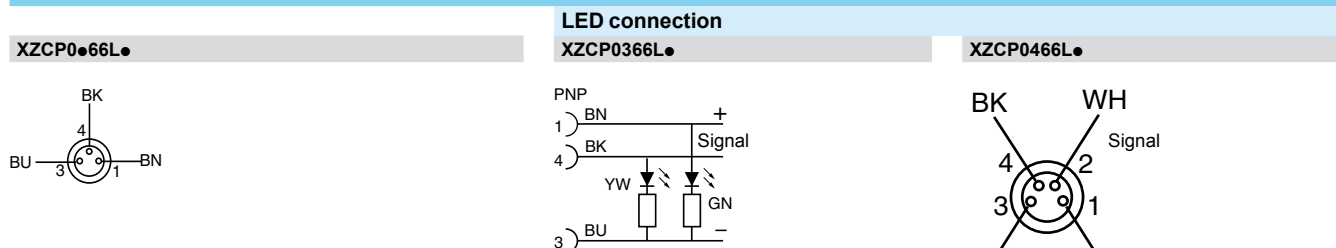



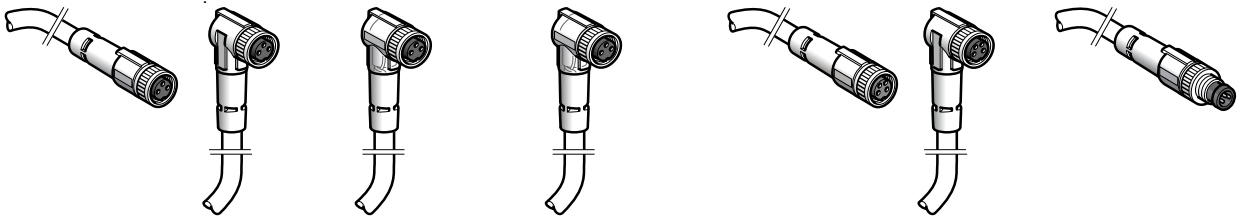

Female, M8, straight	Female, M8, elbowed	Female, M8, elbowed with PNP LED	Female, M8, elbowed with NPN LED	Female, M8, straight	Female, M8, elbowed	Male, M8, straight
3				4		3

<b>XZCP0566L2</b>	<b>XZCP0666L2</b>	<b>XZCP0766L2</b>	<b>XZCP0866L2</b>	<b>XZCP0941L2</b>	<b>XZCP1041L2</b>	<b>XZCP2737L05</b>
<b>XZCP0566L5</b>	<b>XZCP0666L5</b>	<b>XZCP0766L5</b>	<b>XZCP0866L5</b>	<b>XZCP0941L5</b>	<b>XZCP1041L5</b>	<b>XZCP2737L1</b>
<b>XZCP0566L10</b>	<b>XZCP0666L10</b>	<b>XZCP0766L10</b>	<b>XZCP0866L10</b>	<b>XZCP0941L10</b>	<b>XZCP1041L10</b>	<b>XZCP2737L2</b>
0.060 kg (0.13 lb)				0.080 kg (0.18 lb)		0.5 m (1.6 ft) = 0.030 (0.07), 1 m (3.3 ft) = 0.050 (0.11), 2 m (6.6 ft) = 0.080 (0.18)
0.120 kg (0.26 lb)				0.180 kg (0.40 lb)		
0.225 kg (0.50 lb)				0.360 kg (0.79 lb)		

cULus		Screw threaded (metal clamping ring)		Screw threaded (metal clamping ring)		Screw threaded (metal clamping ring)		Screw threaded and clip (metal clamping ring)	
IP67 (with clamping ring correctly tightened)		IP67 (with clamping ring correctly tightened)		IP67 (with clamping ring correctly tightened)		IP67 (with clamping ring correctly tightened)		IP67 (with clamping ring correctly tightened)	
-35 to +90 °C (-31 to +194 °F)		-35 to +90 °C (-31 to +194 °F)		-35 to +90 °C (-31 to +194 °F)		-35 to +90 °C (-31 to +194 °F)		-35 to +90 °C (-31 to +194 °F)	
-5 to +90 °C (23 to +194 °F)		-5 to +90 °C (23 to +194 °F)		-5 to +90 °C (23 to +194 °F)		-5 to +90 °C (23 to +194 °F)		-5 to +90 °C (23 to +194 °F)	
Ø5.2 mm cable, conductor c.s.a.: 3 x 0.34 mm <sup>2</sup>		Ø5.2 mm cable, conductor c.s.a.: 3 x 0.34 mm <sup>2</sup>		Ø5.2 mm cable, conductor c.s.a.: 3 x 0.34 mm <sup>2</sup>		Ø5.2 mm cable, conductor c.s.a.: 4 x 0.34 mm <sup>2</sup>		Ø5.2 mm cable, conductor c.s.a.: 3 x 0.34 mm <sup>2</sup>	
-		2 PNP LEDs		2 NPN LEDs		-		-	
~ 60 V, --- 75 V		--- 10 to 30 V		~ 60 V, --- 75 V		~ 60 V, --- 75 V		~ 60 V, --- 75 V	
4 A		4 A		4 A		4 A		4 A	
> 10 <sup>9</sup> Ω		> 10 <sup>9</sup> Ω		> 10 <sup>9</sup> Ω		> 10 <sup>9</sup> Ω		> 10 <sup>9</sup> Ω	
≤ 5 mΩ		≤ 5 mΩ		≤ 5 mΩ		≤ 5 mΩ		≤ 5 mΩ	

**XZCP0566L●**    **XZCP0666L●**    **XZCP0766L●, XZCP0866L●**    **XZCP0941L●**    **XZCP1041L●**    **XZCP2737L●**

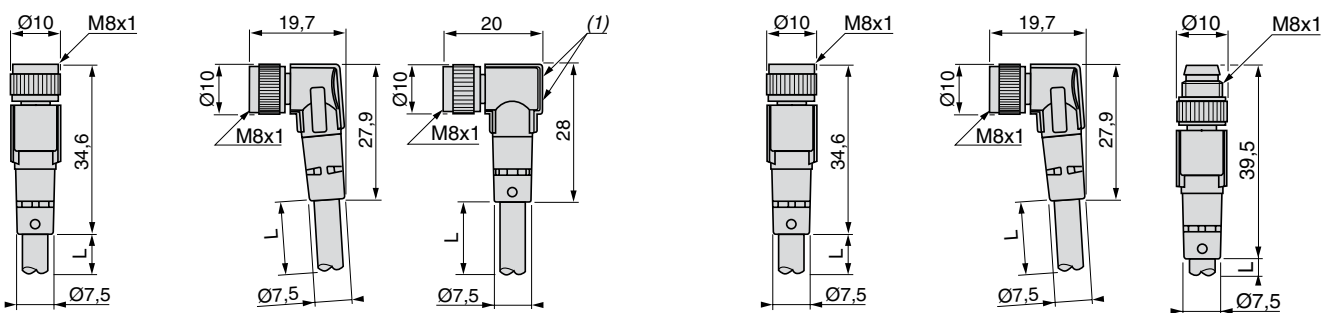

(1) 2 LEDs

Cable: 2, 5, or 10 m (6.6, 16.4, or 32.8 ft).

Cable: 0.5, 1, or 2 m (1.6, 3.3, or 6.6 ft).

**XZCP0●66L●**    **LED connection**    **XZCP0766L●**    **XZCP0866L●**    **XZCP●●41L●**    **XZCP2737L●**

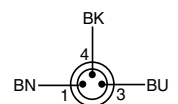
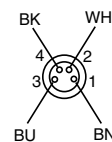
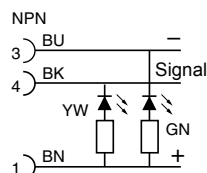
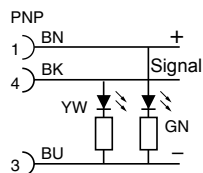
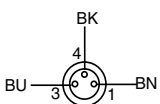

# OsiSense™ XZ Machine cabling accessories

Pre-wired connectors, M12  
PUR cable

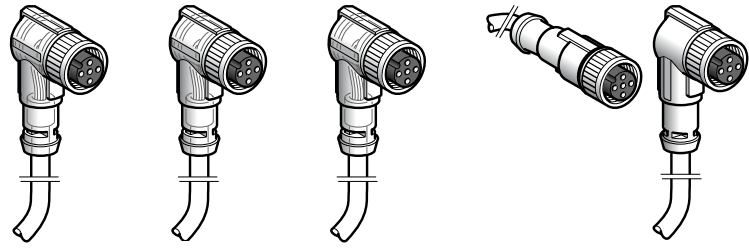

Connector type	Female, M12, elbowed with LED	Female, M12, elbowed with LED	Female, M12, elbowed with LED	Female, M12, straight	Female, M12, elbowed
Number of pins	3			4	

## Catalog numbers

PUR cable (see page 12)	0.5 m (1.6 ft)	-				
	1 m (3.3 ft)	-				
	2 m (6.6 ft)	XZCP2540L2	XZCP1340L2	XZCP1440L2	XZCP1141L2	XZCP1241L2
	5 m (16.4 ft)	XZCP2540L5	XZCP1340L5	XZCP1440L5	XZCP1141L5	XZCP1241L5
	10 m (32.8 ft)	XZCP2540L10	XZCP1340L10	XZCP1440L10	XZCP1141L10	XZCP1241L10
	15 m (49.2 ft)	-	-	-	XZCP1141L15	XZCP1241L15
Weight, kg (lb)	20 m (65.6 ft)	-	-	-	XZCP1141L20	XZCP1241L20
	2 m (6.6 ft)	0.080 (0.18)			0.090 kg (0.20 lb)	
	5 m (16.4 ft)	0.180 (0.40)			0.190 kg (0.42 lb)	
	10 m (32.8 ft)	0.350 (0.77)			0.370 kg (0.82 lb)	
	15 m (49.2 ft)	-			0.500 kg (1.10 lb)	
20 m (65.6 ft)	-			0.750 kg (1.65 lb)		

## Specifications

Certifications	cULus				
Connection type	Screw threaded (stainless steel clamping ring)		Screw threaded (metal clamping ring)		Screw threaded (metal clamping ring)
Degree of protection	IP67 (with clamping ring correctly tightened)				IP67 (with clamping ring correctly tightened)
Ambient air temperature	Static cable	-35 to +90 °C (-31 to +194 °F)			-35 to +90 °C (-31 to +194 °F)
	Flexing cable	-5 to +90 °C (23 to +194 °F)			-5 to +90 °C (23 to +194 °F)
Cabling	Ø5.2 mm cable, conductor c.s.a.: 3 x 0.34 mm <sup>2</sup>				Ø5.2 mm cable, conductor c.s.a.: 4 x 0.34 mm <sup>2</sup>
LED indicators	2 PNP LEDs	2 PNP LEDs	2 NPN LEDs	-	
Nominal voltage	~ 10 to 30 V				~ 250 V, ~ 300 V
Nominal current	4 A				4 A
Insulation resistance	> 10 <sup>9</sup> Ω				> 10 <sup>9</sup> Ω
Contact resistance	≤ 5 mΩ				≤ 5 mΩ

## Dimensions

XZCP2540L●, XZCP1340L●, XZCP1440L●

XZCP1141L●

XZCP1241L●

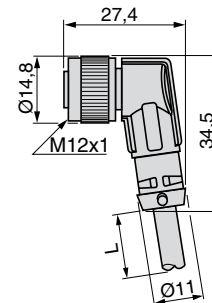
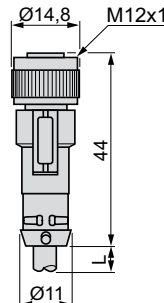
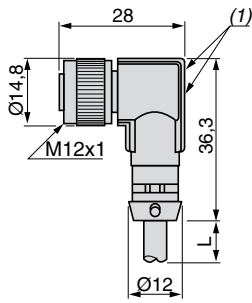

(1) 2 LEDs. Cable: 2, 5, or 10 m (6.6, 16.4, or 32.8 ft).

## Connections

### LED connection

XZCP2540L●, XZCP1440L●

XZCP2540L●, XZCP1340L●

XZCP1440L●

XZCP1241L●

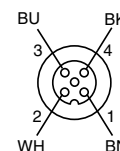
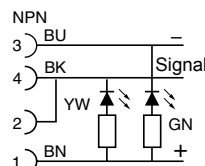
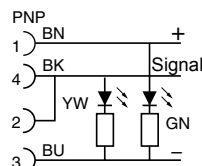
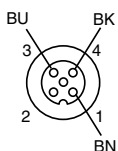

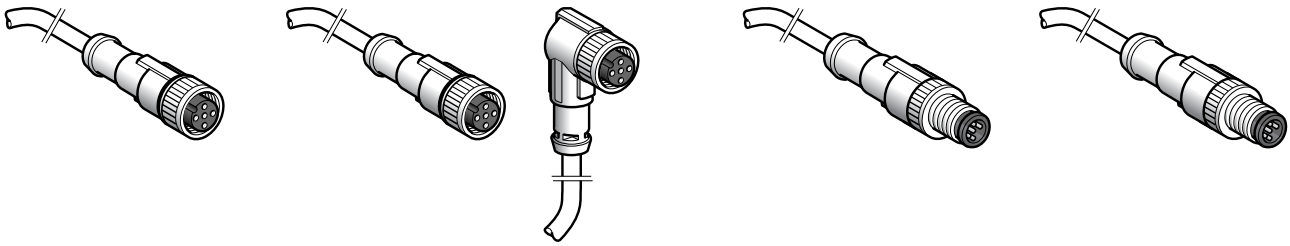

Female, M12, straight	Female, M12, straight	Female, M12, elbowed	Male, M12, straight	Male, M12, straight
4	5	5	4	5
-	-	-	XZCP1541L05	XZCP1564L05
-	-	-	XZCP1541L1	XZCP1564L1
XZCP1169L2	XZCP1164L2	XZCP1264L2	XZCP1541L2	XZCP1564L2
XZCP1169L5	XZCP1164L5	XZCP1264L5	-	-
XZCP1169L10	XZCP1164L10	XZCP1264L10	-	-
-	-	-	-	-
-	-	-	-	-
0.105 (0.23)	0.115 (0.25)	-	0.5 m (1.6 ft) = 0.030 (0.07)	0.5 m (1.6 ft) = 0.040 (0.09)
0.260 (0.57)	0.270 (0.60)	-	1 m (3.3 ft) = 0.050 (0.11)	1 m (3.3 ft) = 0.065 (0.14)
0.500 (1.10)	0.520 (1.15)	-	2 m (6.6 ft) = 0.085 (0.19)	2 m (6.6 ft) = 0.115 (0.25)
-	-	-	-	-
-	-	-	-	-

cULus		cULus	
Screw threaded (metal clamping ring)		Screw threaded (metal clamping ring)	
IP67 (with clamping ring correctly tightened)		IP67 (with clamping ring correctly tightened)	
-35 to +90 °C (-31 to +194 °F)		-35 to +90 °C (-31 to +194 °F)	
-5 to +90 °C (23 to +194 °F)		-5 to +90 °C (23 to +194 °F)	
Ø5.7 mm cable, conductor c.s.a.: 4 x 0.34 mm <sup>2</sup>	Ø5.9 mm cable, conductor c.s.a.: 5 x 0.34 mm <sup>2</sup>	Ø5.2 mm cable, conductor c.s.a.: 4 x 0.34 mm <sup>2</sup>	Ø5.9 mm cable, conductor c.s.a.: 4 x 0.34 mm <sup>2</sup> + 1 x 0.5 mm <sup>2</sup>
-	-	-	-
~ 250 V, ~ 300 V	~ 30 V, ~ 36 V	~ 250 V, ~ 300 V	~ 30 V, ~ 36 V
4 A	4 A	4 A	4 A
> 10 <sup>9</sup> Ω	> 10 <sup>9</sup> Ω	> 10 <sup>9</sup> Ω	> 10 <sup>9</sup> Ω
≤ 5 mΩ	≤ 5 mΩ	≤ 5 mΩ	≤ 5 mΩ

**XZCP1169L, XZCP1164L**      **XZCP1264L**      **XZCP1541L, XZCP1564L**

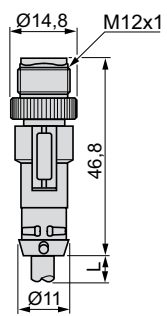
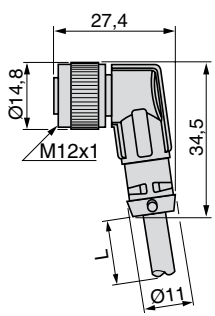
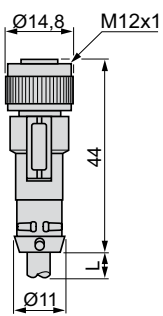

Cable: 2, 5, or 10 m (6.6, 16.4, or 32.8 ft).

Cable: 0.5, 1, or 2 m (1.6, 3.3, or 6.6 ft).

**XZCP1169L**      **XZCP1164L**      **XZCP1541L**      **XZCP1564L**

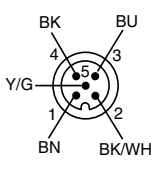
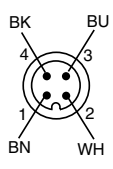
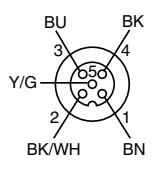
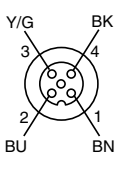

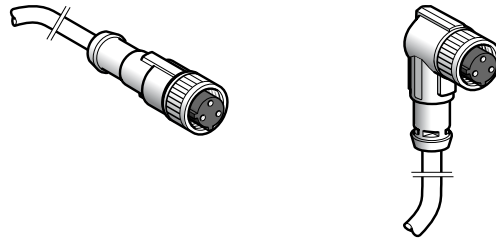

<b>Connector type</b>	Female, 1/2"-20UNF, straight	Female, 1/2"-20UNF, elbowed	
<b>Number of pins</b>	3		
<b>Catalog numbers</b>			
<b>PUR cable</b> (see page 12)	2 m (6.6 ft)	<b>XZCP1865L2</b>	<b>XZCP1965L2</b>
	5 m (16.4 ft)	<b>XZCP1865L5</b>	<b>XZCP1965L5</b>
	10 m (32.8 ft)	<b>XZCP1865L10</b>	<b>XZCP1965L10</b>
<b>Weight, kg (lb)</b>	2 m (6.6 ft)	0.080 (0.18)	
	5 m (16.4 ft)	0.180 (0.40)	
	10 m (32.8 ft)	0.350 (0.77)	

<b>Specifications</b>	
<b>Certifications</b>	cULus
<b>Connection type</b>	Screw threaded (metal clamping ring)
<b>Degree of protection</b>	IP67 (with clamping ring correctly tightened)
<b>Ambient air temperature</b>	-35 to +80 °C (-31 to +176 °F)
<b>Cabling</b>	Ø5.2 mm cable, conductor c.s.a.: 3 x 0.34 mm <sup>2</sup>
<b>LED indicators</b>	-
<b>Nominal voltage</b>	~ 250 V, --- 300 V
<b>Nominal current</b>	4 A
<b>Insulation resistance</b>	> 10 <sup>9</sup> Ω
<b>Contact resistance</b>	≤ 5 mΩ

### Dimensions

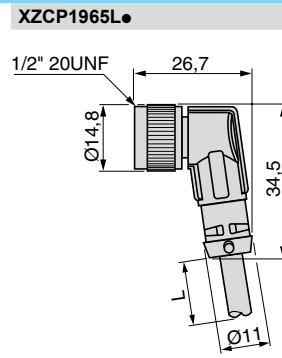
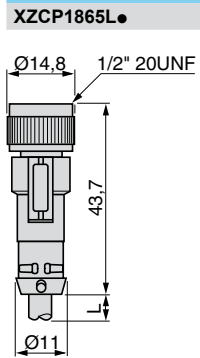

Cable: 2, 5, or 10 m (6.6, 16.4, or 32.8 ft).

### Connections

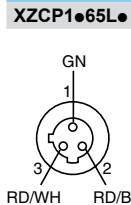

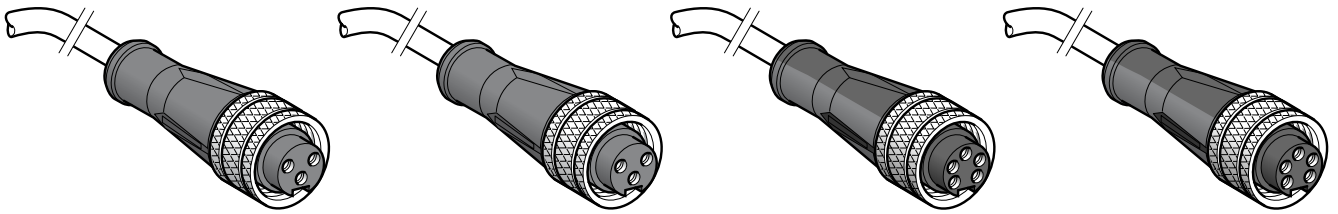

Female, 7/8"-16UN, straight 3	Female, 7/8"-16UN, straight	Female, 7/8"-16UN, straight 5	Female, 7/8"-16UN, straight
<b>XZCP1662L2</b>	<b>XZCP1670L2</b>	<b>XZCP1764L2</b>	<b>XZCP1771L2</b>
<b>XZCP1662L5</b>	<b>XZCP1670L5</b>	<b>XZCP1764L5</b>	<b>XZCP1771L5</b>
–	<b>XZCP1670L10</b>	<b>XZCP1764L10</b>	<b>XZCP1771L10</b>
0.180 kg (0.40 lb)	0.180 kg (0.40 lb)	0.185 kg (0.41 lb)	0.190 kg (0.42 lb)
0.420 kg (0.93 lb)	0.420 kg (0.93 lb)	0.460 kg (1.01 lb)	0.475 kg (1.04 lb)
–	0.820 kg (1.81 lb)	0.900 kg (1.98 lb)	0.950 kg (2.09 lb)
Screw threaded (metal clamping ring) IP67 (with clamping ring correctly tightened) –35 to +80 °C (–31 to +176 °F)		Screw threaded (metal clamping ring) IP67 (with clamping ring correctly tightened) –35 to +80 °C (–31 to +176 °F)	
Ø5 mm cable conductor c.s.a.: 3 x 0.5 mm <sup>2</sup>	Ø5 mm cable conductor c.s.a.: 3 x 0.5 mm <sup>2</sup>	Ø5.9 mm cable conductor c.s.a.: 5 x 0.34 mm <sup>2</sup>	Ø6.7 mm cable conductor c.s.a.: 5 x 0.5 mm <sup>2</sup>
–	–	–	–
~ 250 V	~ 250 V	~ 250 V	~ 250 V
6 A	6 A	4 A	6 A
> 10 <sup>9</sup> Ω	> 10 <sup>9</sup> Ω	> 10 <sup>9</sup> Ω	> 10 <sup>9</sup> Ω
≤ 5 mΩ	≤ 5 mΩ	≤ 5 mΩ	≤ 5 mΩ

**XZCP1662L●, XZCP1670L●, XZCP1764L●, XZCP1771L●**

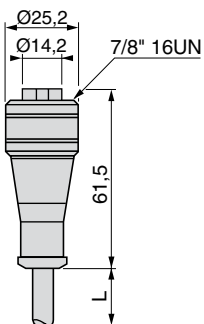

Cable: 2, 5, or 10 m (6.6, 16.4, or 32.8 ft).

<b>XZCP1662L●</b>	<b>XZCP1670L●</b>	<b>XZCP1764L●</b>	<b>XZCP1771L●</b>

# OsiSense™ XZ Machine cabling accessories

Jumper cables, M8-M8 and M8-M12  
PUR cable

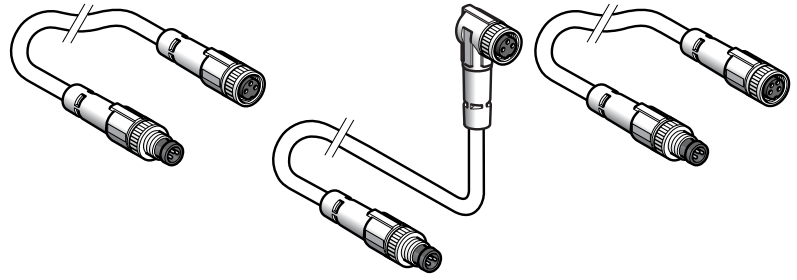

Male connector type	M8, 3-pin, straight		
Female connector type	M8, 3-pin, straight	M8, 3-pin, elbowed	M8, 4-pin, straight
Number of conductors	3	3	3

## Catalog numbers

PUR cable	1 m (3.3 ft)	<b>XZCR2705037R1</b>	<b>XZCR2706037R1</b>	<b>XZCR2709037S1</b>
	2 m (6.6 ft)	<b>XZCR2705037R2</b>	<b>XZCR2706037R2</b>	<b>XZCR2709037S2</b>
Weight, kg (lb)	1 m (3.3 ft)	0.060 (0.13)		
	2 m (6.6 ft)	0.090 (0.20)		

## Specifications

Certifications	cULus		
Connection type	Male: screw threaded and clip. Female: screw threaded. Metal clamping ring.		
Degree of protection	IP67		
Ambient air temperature	Static cable	-35 to +90 °C (-31 to +194 °F)	
	Flexing cable	-5 to +90 °C (23 to +194 °F)	
Conductor c.s.a.	3 x 0.34 mm <sup>2</sup>		
Cable diameter	5.2 mm		
Nominal voltage	~ 60 V, ~ 45 V		
Nominal current	4 A		
Insulation resistance	> 10 <sup>9</sup> Ω		
Contact resistance	≤ 5 mΩ		

## Dimensions

### XZCR2705037R●

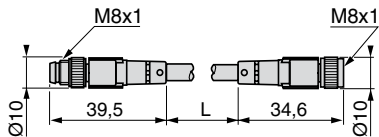

### XZCR2706037R●

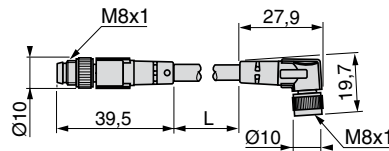

### XZCR2709037S●

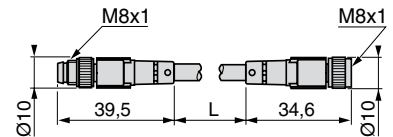

Cable: 1 or 2 m (3.3 or 6.6 ft).

## Connections

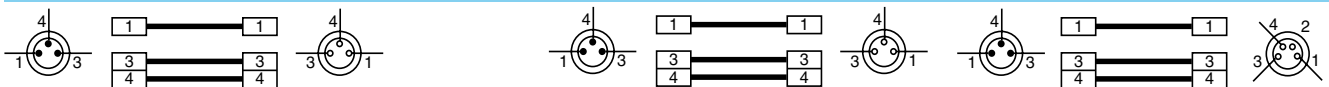

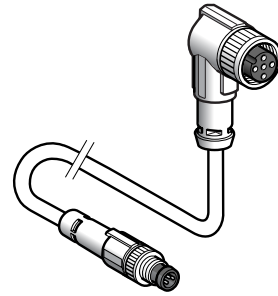
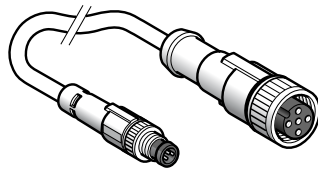
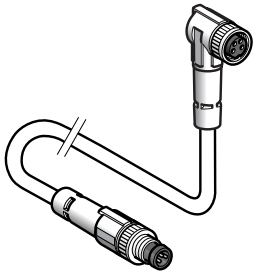

M8, 3-pin, straight

M8, 4-pin, elbowed

M12, 5-pin, straight

M12, 5-pin, elbowed

3

3

3

**XZCR2710037S1**

**XZCR2711037T1**

**XZCR2712037T1**

**XZCR2710037S2**

**XZCR2711037T2**

**XZCR2712037T2**

0.060 (0.13)

0.065 (0.14)

0.065 (0.14)

0.090 (0.20)

0.093 (0.21)

0.093 (0.21)

cULus

Male: screw threaded and clip. Female: screw threaded. Metal clamping ring.

IP67

-35 to +90 °C (-31 to +194 °F)

-5 to +90 °C (23 to +194 °F)

3 x 0.34 mm<sup>2</sup>

5.2 mm

~ 60 V, ~ 45 V

4 A

> 10<sup>9</sup> Ω

≤ 5 mΩ

**XZCR2710037S●**

**XZCR2711037T●**

**XZCR2712037T●**

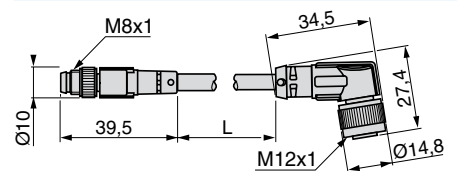
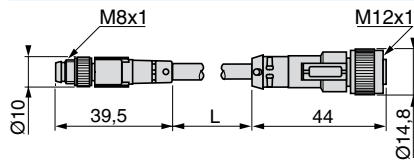
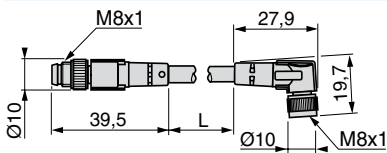

Cable: 1 or 2 m (3.3 or 6.6 ft).

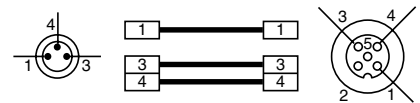
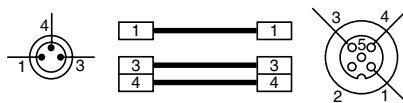
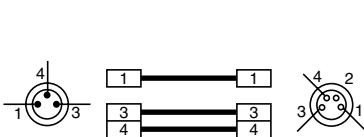



# OsiSense™ XZ Machine cabling accessories

Jumper cables, Ø8 mm-M12 and M8-M12  
PUR cable

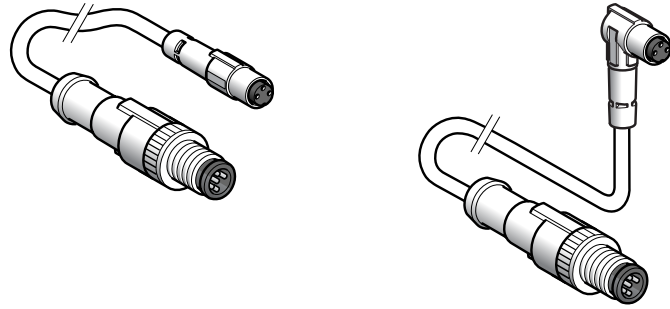

		<b>Clip</b>	
<b>Male connector type</b>		M12, 3-pin, straight	
<b>Female connector type</b>		Ø8 mm, 3-pin, straight	Ø8 mm, 3-pin, elbowed
<b>Number of conductors</b>		3	
<b>Catalog numbers</b>			
<b>PUR cable</b> (see page 12)	1 m (3.3 ft)	<b>XZCR1501040G1</b>	<b>XZCR1502040G1</b>
	2 m (6.6 ft)	<b>XZCR1501040G2</b>	<b>XZCR1502040G2</b>
<b>Weight, kg (lb)</b>	1 m (3.3 ft)	0.050 (0.11)	
	2 m (6.6 ft)	0.080 kg (0.18 lb)	

<b>Specifications</b>	
<b>Certifications</b>	cULus
<b>Connection type</b>	Male: screw threaded. Female: clip (1).
<b>Degree of protection</b>	IP67 (when correctly clipped together or with clamping ring correctly tightened)
<b>Ambient air temperature</b>	Static cable Flexing cable
	-35 to +90 °C (-31 to +194 °F) -5 to +90 °C (+23 to +194 °F)
<b>Conductor c.s.a.</b>	3 x 0.34 mm <sup>2</sup>
<b>Cable diameter</b>	5.2 mm
<b>Nominal voltage</b>	~ 60 V, --- 75 V
<b>Nominal current</b>	4 A
<b>Insulation resistance</b>	> 10 <sup>9</sup> Ω
<b>Contact resistance</b>	≤ 5 mΩ

## Dimensions

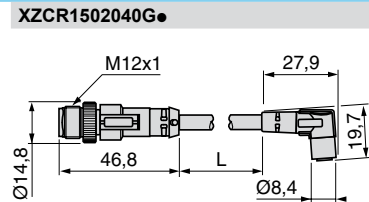
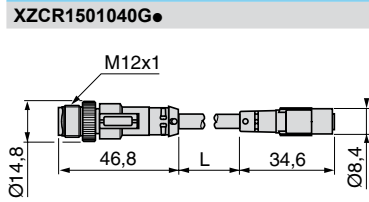

Cable: 1 or 2 m (3.3 or 6.6 ft).

## Connections

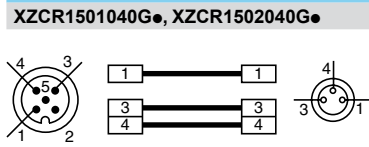

(1) Clip-together connector, without clamping ring.

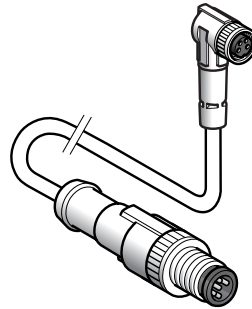
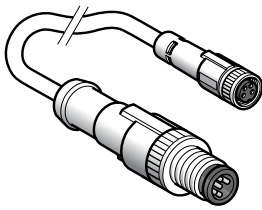

**Screw threaded**

M12, 3-pin, straight		M12, 4-pin, straight	
M8, 3-pin, straight	M8, 3-pin, elbowed	M8, 4-pin, straight	M8, 4-pin, elbowed
3		4	

<b>XZCR1509040H1</b>	<b>XZCR1510040H1</b>	<b>XZCR1509041J1</b>	<b>XZCR1510041J1</b>
<b>XZCR1509040H2</b>	<b>XZCR1510040H2</b>	<b>XZCR1509041J2</b>	<b>XZCR1510041J2</b>
0.050 (0.11)		0.055 (0.12)	
0.080 (0.18)		0.090 (0.20)	

**cULus**

Male and female: screw threaded	
IP67 (with clamping ring correctly tightened)	
-35 to +90 °C (-31 to +194 °F)	
-5 to +90 °C (23 to +194 °F)	
3 x 0.34 mm <sup>2</sup>	4 x 0.34 mm <sup>2</sup>
5.2 mm	
~ 60 V, ~ 75 V	
4 A	
> 10 <sup>9</sup> Ω	
≤ 5 mΩ	

**XZCR1509040H●, XZCR1509041J●**

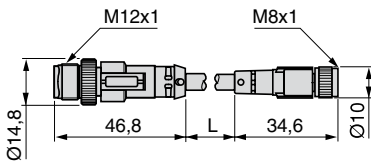

**XZCR1510040H●, XZCR1510041J●**

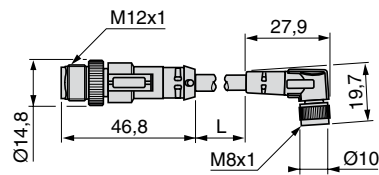

Cable: 1 or 2 m (3.3 or 6.6 ft).

**XZCR1509040H●, XZCR1510040H●**

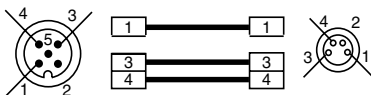

**XZCR1509041J●, XZCR1510041J●**

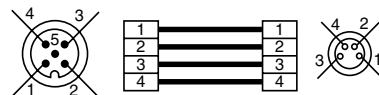

# OsiSense™ XZ Machine cabling accessories

Jumper cables, M12-M12 and EN 175301-803-A-M12 (1)  
PUR cable

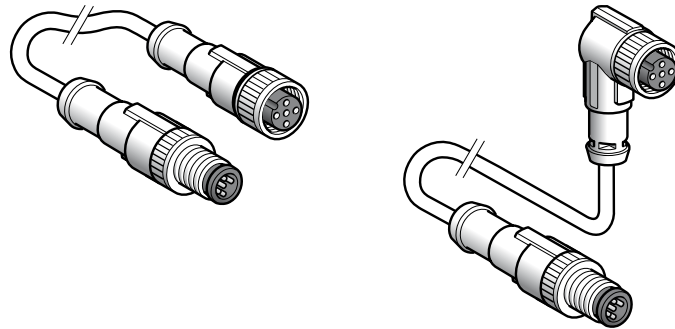

<b>Male connector type</b>	M12, 3-pin, straight				
<b>Female connector type</b>	M12, 3-pin, straight	M12, 3-pin, elbowed	M12, 3-pin, straight	M12, 3-pin, elbowed	
<b>Number of conductors</b>	3				
<b>Catalog numbers</b>					
<b>PUR cable</b> (see page 12)	1 m (3.3 ft)	<b>XZCR1511040A1</b>	<b>XZCR1512040A1</b>	<b>XZCR1511040E1</b>	<b>XZCR1512040E1</b>
	2 m (6.6 ft)	<b>XZCR1511040A2</b>	<b>XZCR1512040A2</b>	<b>XZCR1511040E2</b>	<b>XZCR1512040E2</b>
<b>Weight</b>	1 m (3.3 ft)	0.065 (0.14)			
	2 m (6.6 ft)	0.095 (0.21)			

## Specifications

<b>Certifications</b>	cULus	
<b>Connection type</b>	Male and female: screw threaded	
<b>Degree of protection</b>	IP67 (with clamping ring correctly tightened)	
<b>Ambient air temperature</b>	Static cable	-35 to +90 °C (-31 to +194 °F)
	Flexing cable	-5 to +90 °C (+23 to +194 °F)
<b>Conductor c.s.a.</b>	3 x 0.34 mm <sup>2</sup>	
<b>Cable diameter</b>	5.2 mm	
<b>Nominal voltage</b>	~ 250 V, ~ 300 V	
<b>Nominal current</b>	4 A	
<b>Insulation resistance</b>	> 10 <sup>9</sup> Ω	
<b>Contact resistance</b>	≤ 5 mΩ	

## Dimensions

XZCR1511040A●, XZCR1511040E●

XZCR1512040A●, XZCR1512040E●

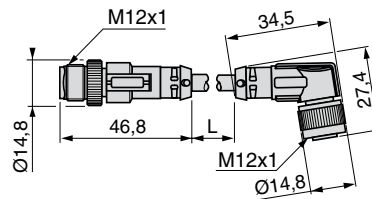
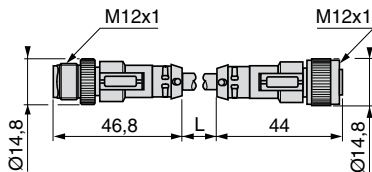

Cable: 1 or 2 m (3.3 or 6.6 ft).

## Connections

XZCR1511040A●, XZCR1512040A●

XZCR1511040E●, XZCR1512040E●

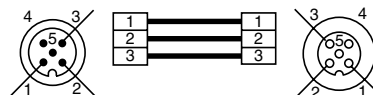
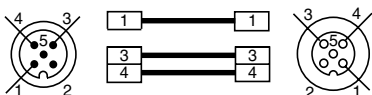

(1) EN 175301-803-A: ex-DIN 43650 A.

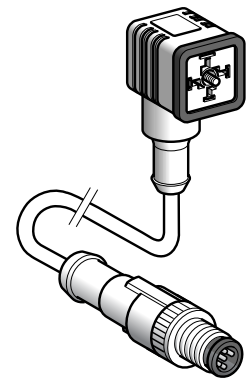
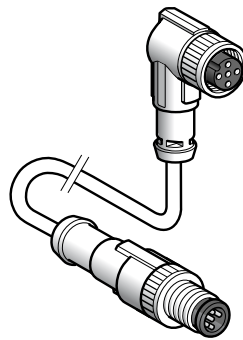
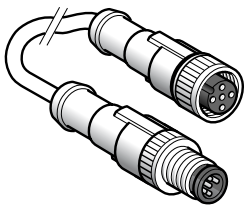

M12, 3-pin, straight	M12, 3-pin, straight	M12, 3-pin, elbowed	M12, 3-pin, straight	M12, 3-pin, elbowed	EN 175301-803-A, elbowed (1)
----------------------	----------------------	---------------------	----------------------	---------------------	------------------------------

3

<b>XZCR1511062B1</b>	<b>XZCR1512062B1</b>	<b>XZCR1511062F1</b>	<b>XZCR1512062F1</b>	<b>XZCR1523062K1</b>
<b>XZCR1511062B2</b>	<b>XZCR1512062B2</b>	<b>XZCR1511062F2</b>	<b>XZCR1512062F2</b>	<b>XZCR1523062K2</b>
0.065 kg (0.14)				0.110 (0.24)
0.095 kg (0.21)				0.140 (0.31)

cULus	-
Male and female: screw threaded	
IP67 (with clamping ring correctly tightened)	
-35 to +90 °C (-31 to +194 °F)	
-5 to +90 °C (+23 to +194 °F)	
3 x 0.5 mm <sup>2</sup>	3 x 0.50 mm <sup>2</sup>
5.2 mm	4.5 mm
~ 30 V, ~ 36 V	
4 A	
> 10 <sup>9</sup> Ω	
≤ 5 mΩ	

<b>XZCR1511062B●, XZCR1511062F●</b>	<b>XZCR1512062B●, XZCR1512062F●</b>	<b>XZCR1523062K●</b>
-------------------------------------	-------------------------------------	----------------------

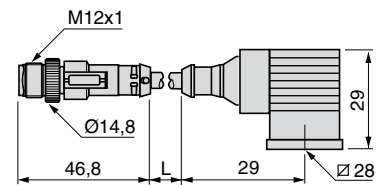
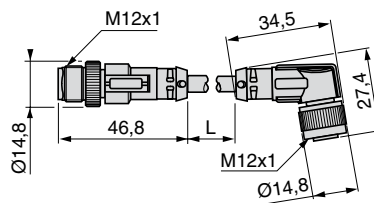
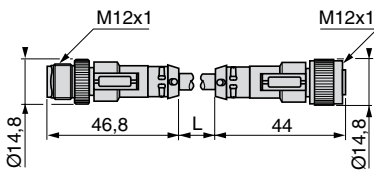

Cable: 1 or 2 m (3.3 or 6.6 ft).

<b>XZCR1511062B●, XZCR1512062B●</b>	<b>XZCR1511062F●, XZCR1512062F●</b>	<b>XZCR1523062K●</b>
-------------------------------------	-------------------------------------	----------------------

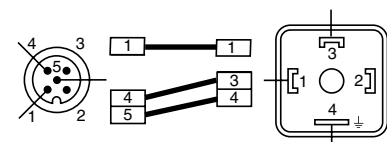
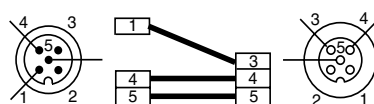
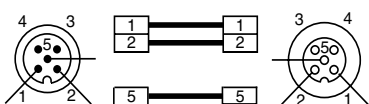

(1) EN 175301-803-A: ex-DIN 43650 A.

# OsiSense™ XZ Machine cabling accessories

Jumper cables, M12-M12  
PUR cable

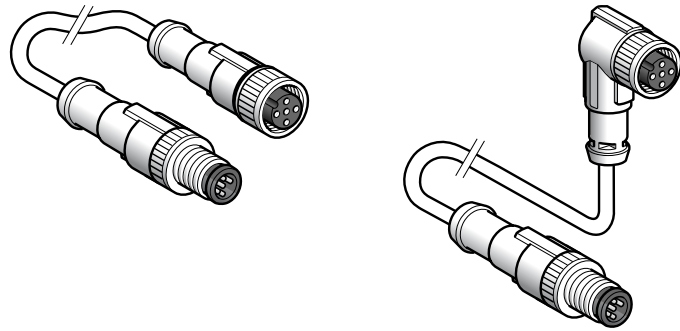

<b>Male connector type</b>	M12, 4-pin, straight	
<b>Female connector type</b>	M12, 4-pin, straight	M12, 4-pin, elbowed
<b>Number of conductors</b>	4	

## Catalog numbers

<b>PUR cable</b> (see page 12)	1 m (3.3 ft)	<b>XZCR1511041C1</b>	<b>XZCR1512041C1</b>
	2 m (6.6 ft)	<b>XZCR1511041C2</b>	<b>XZCR1512041C2</b>
<b>Weight, kg (lb)</b>	1 m (3.3 ft)	0.065 (0.14)	
	2 m (6.6 ft)	0.095 (0.21)	

## Specifications

<b>Certifications</b>	cULus	
<b>Connection type</b>	Male and female: screw threaded	
<b>Degree of protection</b>	IP67 (with clamping ring correctly tightened)	
<b>Ambient air temperature</b>	Static cable	-35 to +90 °C (-31 to +194 °F)
	Flexing cable	-5 to +90 °C (+23 to +194 °F)
<b>Conductor c.s.a.</b>	4 x 0.34 mm <sup>2</sup>	
<b>Cable diameter</b>	5.2 mm	
<b>Nominal voltage</b>	~ 250 V, --- 300 V	
<b>Nominal current</b>	4 A	
<b>Insulation resistance</b>	> 10 <sup>9</sup> Ω	
<b>Contact resistance</b>	≤ 5 mΩ	

## Dimensions

XZCR1511041C●

XZCR1512041C●

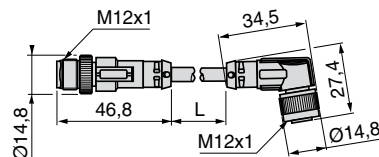
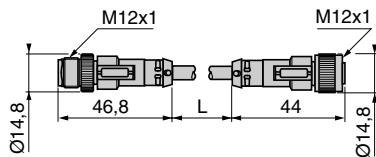

Cable: 1 or 2 m (3.3 or 6.6 ft).

## Connections

XZCR1511041C●, XZCR1512041C●

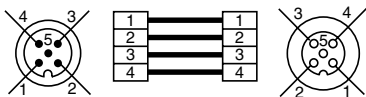

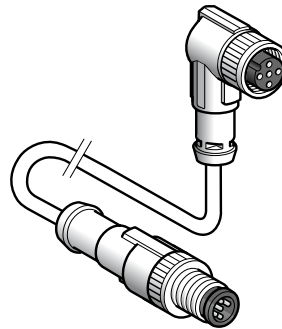
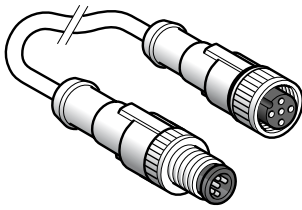

M12, 5-pin, straight

M12, 5-pin, straight

5

M12, 5-pin, elbowed

**XZCR1511064D1**

**XZCR1511064D2**

0.080 (0.18)

0.130 (0.29)

**XZCR1512064D1**

**XZCR1512064D2**

cULus

Male and female: screw threaded

IP67 (with clamping ring correctly tightened)

-35 to +90 °C (-31 to +194 °F)

-5 to +90 °C (23 to +194 °F)

4 x 0.34 mm<sup>2</sup> + 1 x 0.5 mm<sup>2</sup>

5.9 mm

~ 30 V, ~ 36 V

4 A

> 10<sup>9</sup> Ω

≤ 5 mΩ

**XZCR1511064D●**

**XZCR1512064D●**

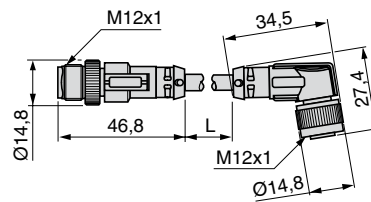
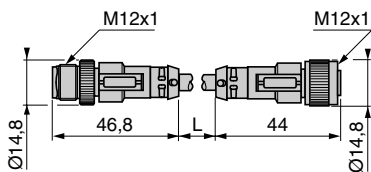

Cable: 1 or 2 m (3.3 or 6.6 ft).

**XZCR1511064D●, XZCR1512064D●**

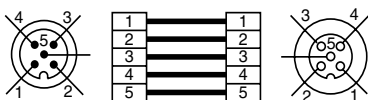

# OsiSense™ XZ Machine cabling accessories

Pre-wired connectors, Application series  
M8, M12 and 1/2"-20UNF  
PVC cable

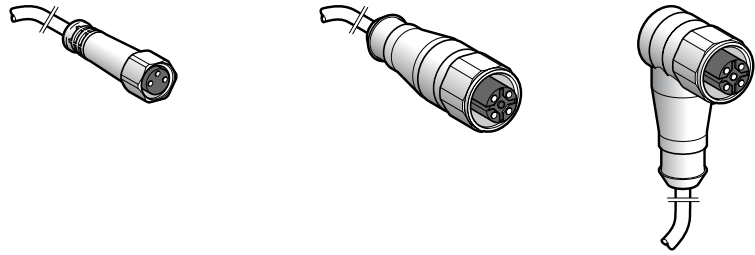

<b>Connector type</b>		Female, M8, straight	Female, M8, straight	Female, M12, straight	Female, M12, elbowed	Female, M12, elbowed
<b>Number of pins</b>		3	4	4	4	5
<b>Catalog numbers</b>						
<b>PVC cable</b> (see page 14)	2 m (6.6 ft)	–	–	XZCPA1141L2	XZCPA1241L2	XZCPA1164L2
	5 m (16.4 ft)	XZCPA0566L5	XZCPA0941L5	XZCPA1141L5	XZCPA1241L5	XZCPA1164L5
	10 m (32.8 ft)	XZCPA0566L10	XZCPA0941L10	XZCPA1141L10	XZCPA1241L10	XZCPA1164L10
<b>Weight, kg (lb)</b>	2 m (6.6 ft)	–	–	0.090 (0.20)	0.090 (0.20)	0.110 (0.24)
	5 m (16.4 ft)	0.175 (0.39)	0.200 (0.44)	0.210 (0.46)	0.210 (0.46)	0.250 (0.55)
	10 m (32.8 ft)	0.340 (0.75)	0.400 (0.88)	0.410 (0.90)	0.410 (0.90)	0.485 (1.07)

## Specifications

<b>Connection type</b>	Clamping ring: screw threaded, smooth, hexagonal, stainless steel 316L, hand-tightening recommended					
<b>Clamping ring dimension</b>	9 mm (0.35 in.)			14 mm (0.55 in.)		
<b>Degree of protection</b>	IP68			IP69K		
<b>Ambient air temperature</b>	Static cable usage	–25 to +85 °C (–13 to +185 °F)				
<b>Cabling</b>	Cable	Ø5.0 mm	Ø5.3 mm	Ø5.3 mm	Ø5.3 mm	Ø5.7 mm
	Conductor c.s.a.	3 x 0.34 mm <sup>2</sup>	4 x 0.34 mm <sup>2</sup>	4 x 0.34 mm <sup>2</sup>	4 x 0.34 mm <sup>2</sup>	5 x 0.34 mm <sup>2</sup>
<b>Nominal voltage</b>	~ 60 V, ~ 75 V			~ 250 V, ~ 300 V		
<b>Nominal current</b>	4 A			4 A		
<b>Insulation resistance</b>	> 10 <sup>9</sup> Ω			> 10 <sup>9</sup> Ω		
<b>Contact resistance</b>	≤ 5 mΩ			≤ 5 mΩ		

## Dimensions

XZCPA0566L●, XZCPA0941L●

XZCPA1141L●

XZCPA1241L●, XZCPA1164L●

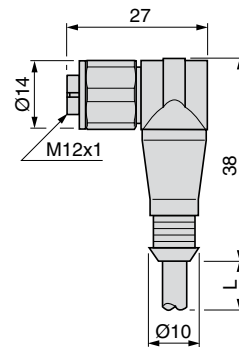
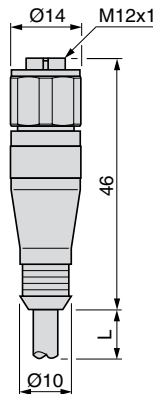
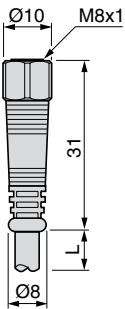

Cable: 2, 5, or 10 m (6.6, 16.4, or 32.8 ft).

## Connections

XZCPA0566L●

XZCPA0941L●

XZCPA1141L●, XZCPA1241L●

XZCPA1164L●

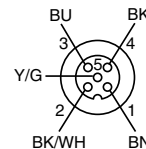
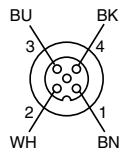
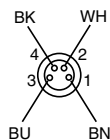
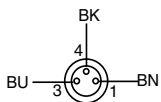



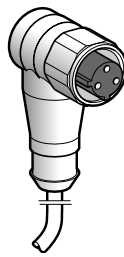
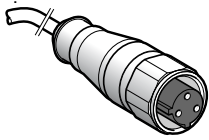

Female, 1/2"-20UNF,  
straight  
3

Female, 1/2"-20UNF,  
elbowed  
3

-

-

**XZCPA1865L5**  
**XZCPA1865L10**

**XZCPA1965L5**  
**XZCPA1965L10**

-

-

0.210 (0.46)  
0.410 (0.90)

0.250 (0.55)  
0.485 (1.07)

Clamping ring: screw threaded, smooth, hexagonal, stainless steel 316L, hand-tightening recommended

14 mm (0.55 in.)

IP69K

-25 to +85 °C (-13 to +185 °F)

Ø5.0 mm

3 x 0.34 mm<sup>2</sup>

3 x 0.34 mm<sup>2</sup>

~ 250 V, --- 300 V

~ 250 V, --- 300 V

4 A

4 A

> 10<sup>9</sup> Ω

> 10<sup>9</sup> Ω

≤ 5 mΩ

≤ 5 mΩ

**XZCPA1865L●**

**XZCPA1965L●**

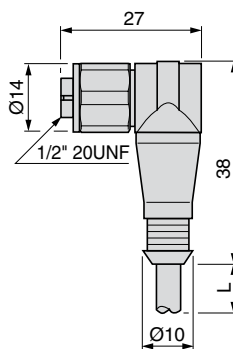
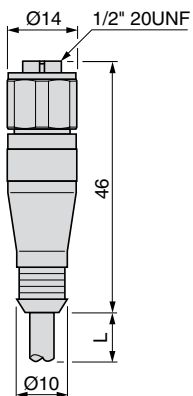

Cable: 5 or 10 m (16.4 or 32.8 ft).

**XZCPA1865L●, XZCPA1965L●**

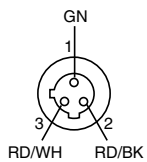

# OsiSense™ XZ Machine cabling accessories

Jumper cables, Application series  
M8-M12 and M12-M12  
PVC cable



<b>Male connector type</b>	M12, 4-pin, straight	M12, 3-pin, straight	
<b>Female connector type</b>	M8, 4-pin, straight	M12, 3-pin, straight	
<b>Number of conductors</b>	4	3	
<b>Catalog numbers</b>			
<b>PVC cable</b> (see page 14)	2 m (6.6 ft)	<b>XZCRA150941J2</b>	<b>XZCRA151140A2</b>
	5 m (16.4 ft)	<b>XZCRA150941J5</b>	<b>XZCRA151140A5</b>
<b>Weight, kg (lb)</b>	2 m (6.6 ft)	0.100 (0.22)	0.095 (0.21)
	5 m (16.4 ft)	0.210 (0.46)	0.200 (0.44)
<b>Specifications</b>			
<b>Certifications</b>	CE		
<b>Connection type</b>	Clamping ring: screw threaded, smooth, hexagonal, stainless steel 316L, hand-tightening recommended		
<b>Clamping ring dimension</b>	14/9 mm (0.55/0.35 in.)	14 mm (0.55 in.)	
<b>Degree of protection</b>	IP68		IP69K
<b>Ambient air temperature</b>	Static cable usage	-25 to +85 °C (-13 to +185 °F)	
<b>Cabling</b>	Cable	Ø5.3 mm	Ø5.0 mm
	Conductor c.s.a.	4 x 0.34 mm <sup>2</sup>	3 x 0.34 mm <sup>2</sup>
<b>Nominal voltage</b>	~ 60 V, --- 75 V		~ 250 V, --- 300 V
<b>Nominal current</b>	4 A		
<b>Insulation resistance</b>	> 10 <sup>9</sup> Ω		
<b>Contact resistance</b>	≤ 5 mΩ		

## Dimensions

**XZCRA150941J●**

**XZCRA151140A●**

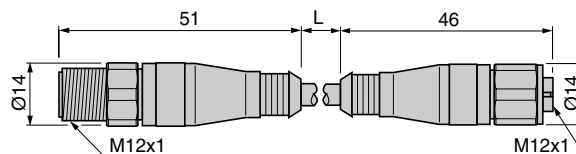
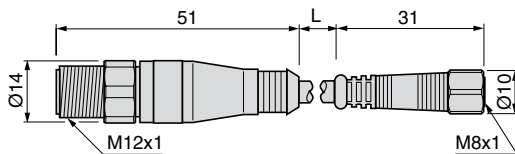

Cable: 2 or 5 m (6.6 or 16.4 ft).

## Connections

**XZCRA150941J●**

**XZCRA151140A●**

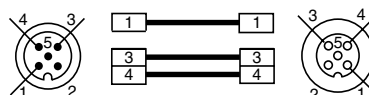
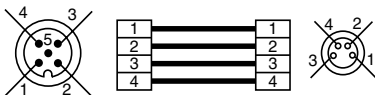

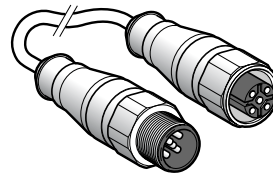
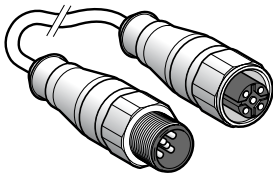

M12, 4-pin, straight	M12, 5-pin, straight
M12, 4-pin, straight	M12, 5-pin, straight
4	5

<b>XZCRA151141C2</b>	<b>XZCRA151164D2</b>
<b>XZCRA151141C5</b>	<b>XZCRA151164D5</b>

0.105 (0.23)	0.120 (0.26)
0.220 (0.49)	0.260 (0.57)

Clamping ring: screw threaded, smooth, hexagonal, stainless steel 316L, hand-tightening recommended

14 mm (0.55 in.)	
IP69K	
-25 to +85 °C (-13 to +185 °F)	
Ø5.3 mm	Ø5.7 mm
4 x 0.34 mm <sup>2</sup>	5 x 0.34 mm <sup>2</sup>
~ 250 V, ~ 300 V	
4 A	
> 10 <sup>9</sup> Ω	
≤ 5 mΩ	

**XZCRA151141C●**

**XZCRA151164D●**

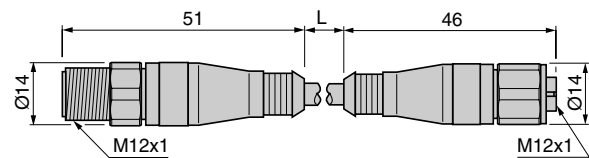
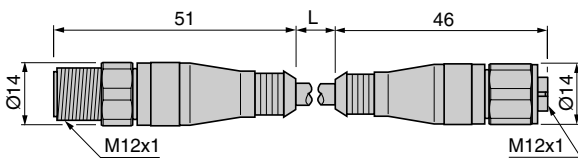

Cable: 2 or 5 m (6.6 or 16.4 ft).

**XZCRA151141C●**

**XZCRA151164D●**

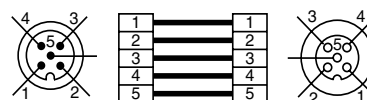
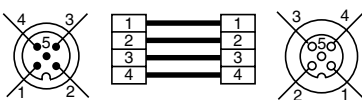

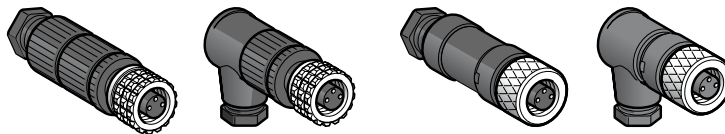

Connector type	Female, M8, straight	Female, M8, elbowed	Female, M8, straight	Female, M8, elbowed
Number of pins	3			
Cable connection	By axial IDC (insulation displacement connector)		Solder terminals	

### Catalog numbers

Plastic body	Metal clamping ring	<b>XZCC8FDM30V</b>	<b>XZCC8FCM30V</b>	<b>XZCC8FDM30S</b>	<b>XZCC8FCM30S</b>
	Plastic clamping ring	-			
Weight, kg (lb)	0.010 (0.02)				

### Specifications

Connection type	Screw threaded (metal clamping ring)	Screw threaded (metal clamping ring)
Degree of protection	IP67 (with clamping ring correctly tightened)	IP67 (with clamping ring correctly tightened)
Ambient air temperature	-25 to +70 °C (-13 to +158 °F)	-40 to +85 °C (-40 to +185 °F)
Cabling	By IDC (insulation displacement connector). Conductor diameter: 1 to 1.55 mm. Cable gland: M9.5 x 1. Maximum clamping capacity: 5 mm.	Solder terminals. Maximum conductor c.s.a.: 0.25 mm <sup>2</sup> . Cable gland: M9.5 x 1. Maximum clamping capacity: 5 mm.
LED indicators	-	
Nominal voltage	~ 60 V, ~ 75 V	~ 60 V, ~ 75 V
Nominal current	4 A	4 A
Insulation resistance	> 10 <sup>9</sup> Ω	> 10 <sup>9</sup> Ω
Contact resistance	≤ 10 mΩ	≤ 5 mΩ

### Dimensions

XZCC8FDM30V	XZCC8FCM30V	XZCC8FDM30S	XZCC8FCM30S

(1) Cable gland: M9.5 x 1.

### Connections

XZCC8FDM30●, XZCC8FCM30●





Female, M8, straight	Female, M8, elbowed	Female, M8, straight	Female, M8, elbowed	Male, M8, straight
4				3
By axial IDC (insulation displacement connector)		Solder terminals		By axial IDC (insulation displacement connector)

<b>XZCC8FDM40V</b>	<b>XZCC8FCM40V</b>	<b>XZCC8FDM40S</b>	<b>XZCC8FCM40S</b>	<b>XZCC8MDM30V</b>
--------------------	--------------------	--------------------	--------------------	--------------------

-	-	-	-	-
0.010 (0.02)				
Screw threaded (metal clamping ring)	Screw threaded (metal clamping ring)	Screw threaded (metal clamping ring)	Screw threaded (metal clamping ring)	Screw threaded (metal clamping ring)
IP67 (with clamping ring correctly tightened)	IP67 (with clamping ring correctly tightened)	IP67 (with clamping ring correctly tightened)	IP67 (with clamping ring correctly tightened)	IP67 (with clamping ring correctly tightened)
-25 to +70 °C (-13 to +158 °F)	-40 to +85 °C (-40 to +185 °F)	-40 to +85 °C (-40 to +185 °F)	-40 to +85 °C (-40 to +185 °F)	-40 to +85 °C (-40 to +185 °F)
By IDC. Conductor diameter: 1 to 1.55 mm (0.04 to 0.06 in.). Cable gland: M9.5 x 1. Maximum clamping capacity: 5 mm.	Solder terminals. Maximum conductor c.s.a.: 0.25 mm <sup>2</sup> . Cable gland: M9.5 x 1. Maximum clamping capacity: 5 mm.	Solder terminals. Maximum conductor c.s.a.: 0.25 mm <sup>2</sup> . Cable gland: M9.5 x 1. Maximum clamping capacity: 5 mm.	Solder terminals. Maximum conductor c.s.a.: 0.25 mm <sup>2</sup> . Cable gland: M9.5 x 1. Maximum clamping capacity: 5 mm.	By IDC. Maximum conductor c.s.a.: 0.25 mm <sup>2</sup> . Cable gland: M9.5 x 1. Maximum clamping capacity: 5 mm.
-	-	-	-	-
~ 60 V, ≐ 75 V	~ 60 V, ≐ 75 V	~ 60 V, ≐ 75 V	~ 60 V, ≐ 75 V	~ 60 V, ≐ 75 V
4 A	4 A	4 A	4 A	4 A
> 10 <sup>9</sup> Ω	> 10 <sup>9</sup> Ω	> 10 <sup>9</sup> Ω	> 10 <sup>9</sup> Ω	> 10 <sup>9</sup> Ω
≤ 10 mΩ	≤ 5 mΩ	≤ 5 mΩ	≤ 5 mΩ	≤ 5 mΩ

<b>XZCC8FDM40V</b>	<b>XZCC8FCM40V</b>	<b>XZCC8FDM40S</b>	<b>XZCC8FCM40S</b>	<b>XZCC8MDM30V</b>
--------------------	--------------------	--------------------	--------------------	--------------------

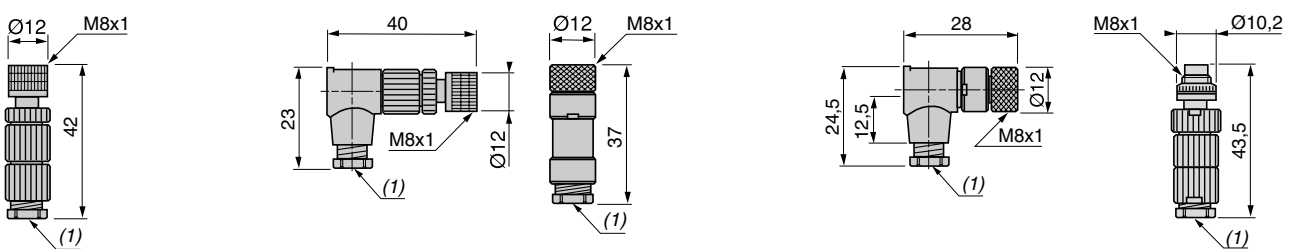

(1) Cable gland: M9.5 x 1.

<b>XZCC8FDM40●, XZCC8FCM40●</b>	<b>XZCC8MDM30V</b>
---------------------------------	--------------------



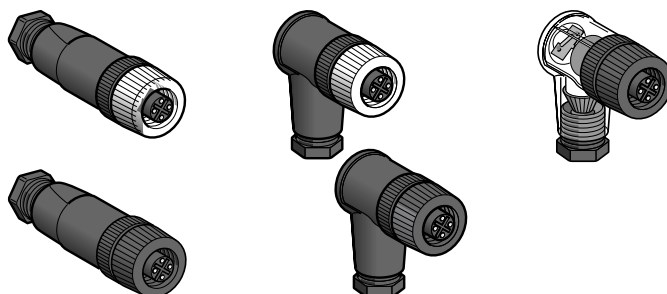

Connector type	Female, M12, straight	Female, M12, elbowed	Female, M12, elbowed
Number of pins	4		
Cable connection	Screw terminals		

### Catalog numbers

Plastic body	Metal clamping ring	<b>XZCC12FDM40B</b>	<b>XZCC12FCM40B</b>	–
	Plastic clamping ring	<b>XZCC12FDP40B</b>	<b>XZCC12FCP40B</b>	<b>XZCC12FCP42B</b>
Weight, kg (lb)	0.020 (0.04)			

### Specifications

Connection type	Screw threaded (plastic or metal clamping ring, depending on the model)		
Degree of protection	IP67 (with clamping ring correctly tightened)		
Ambient air temperature	–40 to +85 °C (–40 to +185 °F)		
Cabling	Screw terminals. Maximum conductor c.s.a.: 0.75 mm <sup>2</sup> . Cable gland: n° 7 plastic (Pg 7). Clamping capacity: 3 to 6 mm.		
LED indicators	–	2 PNP LEDs	
Nominal voltage	~ 125 V, ~ 150 V	~ 10 to 30 V	
Nominal current	3 A	3 A	
Insulation resistance	> 10 <sup>12</sup> Ω	> 10 <sup>12</sup> Ω	
Contact resistance	≤ 8 mΩ	≤ 8 mΩ	

### Dimensions

XZCC12FD●40B

XZCC12FC●40B, XZCC12FCP42B

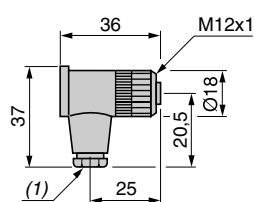
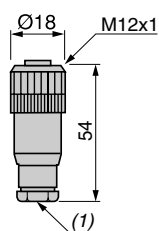

(1) Cable gland: n° 7 plastic (Pg 7).

### Connections

XZCC12FD●40B, XZCC12FC●40B, XZCC12FCP42B

LED connection for XZCC12FCP42B

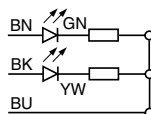

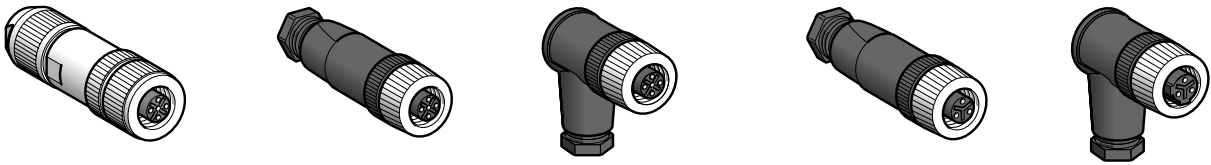

Female, M12, straight, shielded	Female, M12, straight	Female, M12, elbowed	Female, 1/2"-20UNF, straight	Female, 1/2"-20UNF, elbowed
5	5		3	
Spring terminals	Screw terminals			

<b>XZCC12FDB50R</b>	<b>XZCC12FDM50B</b>	<b>XZCC12FCM50B</b>	<b>XZCC20FDM30B</b>	<b>XZCC20FCM30B</b>
-	-			
0.050 (0.11)	0.020 (0.04)			

Screw threaded (metal clamping ring)		
IP67 (with clamping ring correctly tightened)		IP67 (with clamping ring correctly tightened)
-40 to +85 °C (-40 to +185 °F)		-40 to +85 °C (-40 to +185 °F)
Spring terminals. Maximum conductor c.s.a.: 0.5 mm <sup>2</sup> . Clamping capacity: 4 to 8 mm.	Screw terminals. Maximum conductor c.s.a.: 0.75 mm <sup>2</sup> . Cable gland: n° 7 plastic (Pg 7). Clamping capacity: 3 to 6 mm.	
-	-	-
~ 30 V, --- 36 V	~ 30 V, --- 36 V	~ 250 V
4 A	3 A	4 A
> 10 <sup>12</sup> Ω	> 10 <sup>12</sup> Ω	> 10 <sup>12</sup> Ω
≤ 8 mΩ	≤ 8 mΩ	≤ 8 mΩ

<b>XZCC12FDB50R</b>	<b>XZCC12FDM50B</b>	<b>XZCC12FCM50B</b>	<b>XZCC20FDM30B</b>	<b>XZCC20FCM30B</b>
---------------------	---------------------	---------------------	---------------------	---------------------

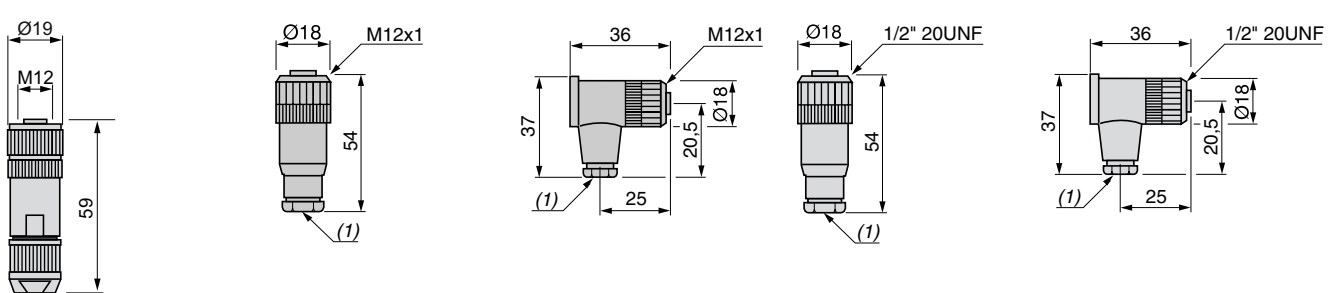

(1) Cable gland: n° 7 plastic (Pg 7).

<b>XZCC12FDB50R, XZCC12F•M50B</b>	<b>XZCC20F•M30B</b>
-----------------------------------	---------------------

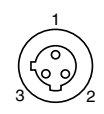
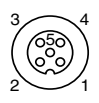



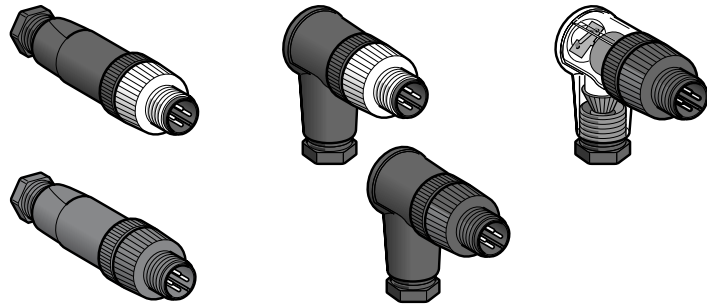

Connector type	Male, M12, straight	Male, M12, elbowed	Male, M12, elbowed
Number of pins	4		
Cable connection	Screw terminals		

### Catalog numbers

Plastic body	Metal clamping ring	<b>XZCC12MDM40B</b>	<b>XZCC12MCM40B</b>	–
	Plastic clamping ring	<b>XZCC12MDP40B</b>	<b>XZCC12MCP40B</b>	<b>XZCC12MCP42B</b>
Weight, kg (lb)	0.025 (0.06)			

### Specifications

Connection type	Screw threaded (plastic or metal clamping ring, depending on the model)		
Degree of protection	IP67 (with clamping ring correctly tightened)		
Ambient air temperature	–40 to +85 °C (–40 to +185 °F)		
Cabling	Screw terminals. Maximum conductor c.s.a.: 0.75 mm <sup>2</sup> . Cable gland: n° 7 plastic (Pg 7). Clamping capacity: 3 to 6 mm.		
LED indicators	–	2 PNP LEDs	
Nominal voltage	~ 125 V, ~ 150 V	~ 10 to 30 V	
Nominal current	3 A	3 A	
Insulation resistance	> 10 <sup>12</sup> Ω	> 10 <sup>12</sup> Ω	
Contact resistance	≤ 8 mΩ	≤ 8 mΩ	

### Dimensions

XZCC12MD●40B

XZCC12MC●40B, XZCC12MCP42B

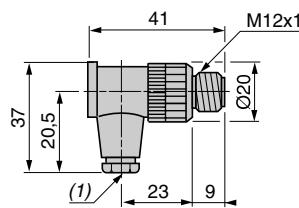
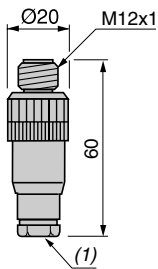

(1) Cable gland: n° 7 plastic (Pg 7).

### Connections

XZCC12MD●40B, XZCC12MC●40B, XZCC12MCP42B

LED connection for XZCC12MCP42B

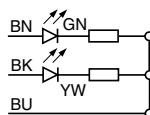

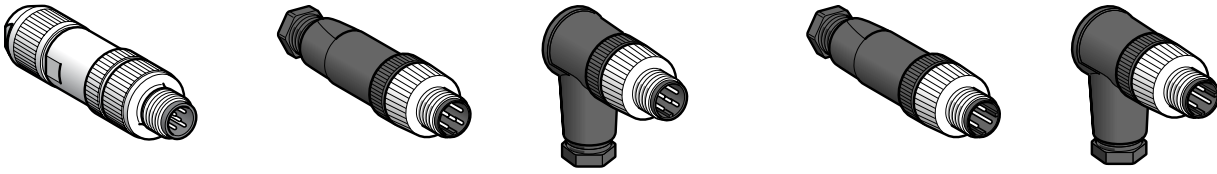

Male, M12, straight, shielded	Male, M12, straight	Male, M12, elbowed	Male, 1/2"-20UNF, straight	Male, 1/2"-20UNF, elbowed
5	5		3	
Spring terminals	Screw terminals			

<b>XZCC12MDB50R</b>	<b>XZCC12MDM50B</b>	<b>XZCC12MCM50B</b>	<b>XZCC20MDM30B</b>	<b>XZCC20MCM30B</b>
-	-			
0.050 (0.11)	0.025 (0.06)			

Screw threaded (metal clamping ring)

IP67 (with clamping ring correctly tightened)

-40 to +85 °C (-40 to +185 °F)

Spring terminals. Maximum conductor c.s.a.: 0.5 mm <sup>2</sup> . Clamping capacity: 4 to 8 mm.	Screw terminals. Maximum conductor c.s.a.: 0.75 mm <sup>2</sup> . Cable gland: n° 7 plastic (Pg 7). Clamping capacity: 3 to 6 mm.	
-	-	-

~ 30 V, --- 36 V	~ 30 V, --- 36 V	~ 250 V
4 A	3 A	4 A
> 10 <sup>12</sup> Ω	> 10 <sup>12</sup> Ω	> 10 <sup>12</sup> Ω
≤ 8 mΩ	≤ 8 mΩ	≤ 8 mΩ

<b>XZCC12MDB50R</b>	<b>XZCC12MDM50B</b>	<b>XZCC12MCM50B</b>	<b>XZCC20MDM30B</b>	<b>XZCC20FCM30B</b>
---------------------	---------------------	---------------------	---------------------	---------------------

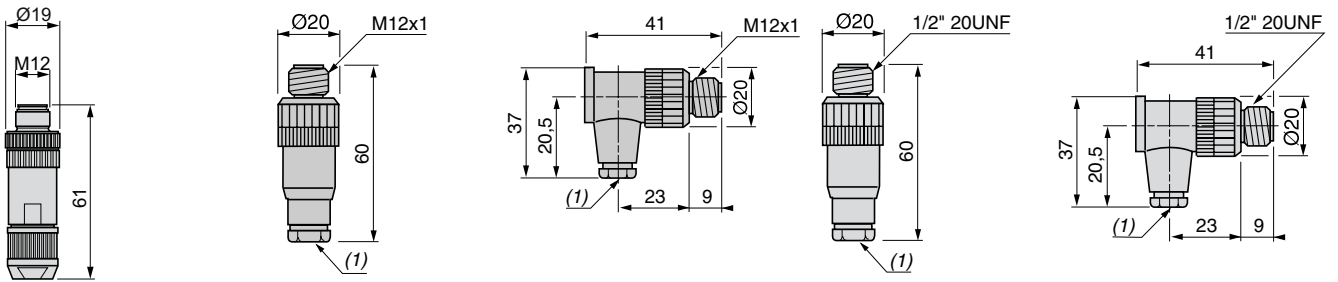

(1) Cable gland: n° 7 plastic (Pg 7).

<b>XZCC12MDB50R, XZCC12M●M50B</b>	<b>XZCC20M●M30B</b>
-----------------------------------	---------------------



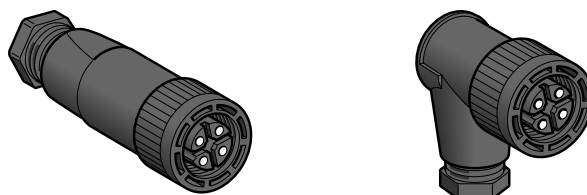

Connector type	Female, M18, straight	Female, M18, elbowed
Number of pins	4	
Cable connection	Screw terminals	

### Catalog numbers

Plastic body	Metal clamping ring	–	
	Plastic clamping ring	<b>XZCC18FDP40B</b>	<b>XZCC18FCP40B</b>
Weight, kg (lb)	0.035 (0.08)		

### Specifications

Connection type	Screw threaded (plastic clamping ring)
Degree of protection	IP65 (with clamping ring correctly tightened)
Ambient air temperature	–40 to +85 °C (–40 to +185 °F)
Cabling	Screw terminals. Maximum conductor c.s.a.: 1.5 mm <sup>2</sup> . Cable gland: n° 9 plastic (Pg 9). Clamping capacity: 5 to 8 mm.
LED indicators	–
Nominal voltage	~ 250 V
Nominal current	16 A
Insulation resistance	> 10 <sup>12</sup> Ω
Contact resistance	≤ 10 mΩ

### Dimensions

**XZCC18FDP40B**

**XZCC18FCP40B**

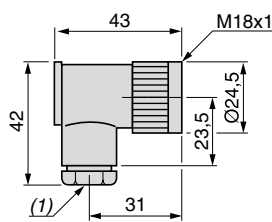
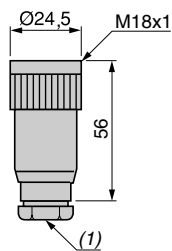

(1) Cable gland: n° 9 plastic (Pg 9).

### Connections

**XZCC18F●P40B**

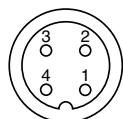

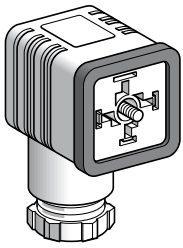

Female, EN 175301-803-A (ex-DIN 43650 A), elbowed

4

Screw terminals

**XZCC43FCP40B**

-

0.035 (0.08)

With locking screw

IP65 (with connector correctly locked)

-40 to +125 °C (-40 to +257 °F)

Screw terminals.  
 Maximum conductor c.s.a.: 1.5 mm<sup>2</sup>.  
 Cable gland: n° 11 plastic (Pg 11).  
 Clamping capacity: 7 to 10 mm.

-

~ 250 V

16 A

> 10<sup>8</sup> Ω

≤ 4 mΩ

**XZCC43FCP40B**

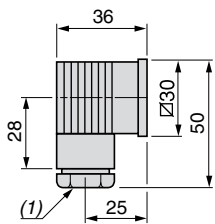

(1) Cable gland: n° 11 plastic (Pg 11).

**XZCC43FCP40B**

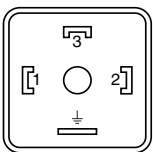

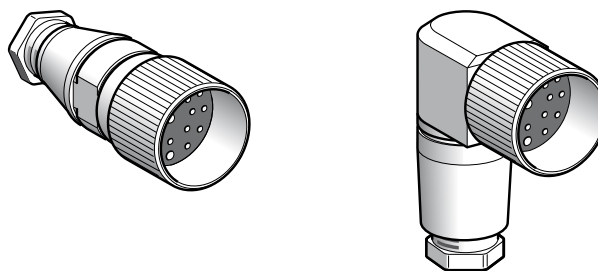

Connector type	Female, M23, straight	Female, M23, elbowed
Number of pins	19	
Cable connection	Solder terminals	

### Catalog numbers

Metal body and metal clamping ring	Contacts numbered counter-clockwise	<b>XZCC23FDM190S</b>	<b>XZCC23FCM190S</b>
Weight, kg (lb)		0.080 (0.18)	0.150 (0.33)

### Specifications

Connection type	Screw threaded (metal clamping ring)
Degree of protection	IP65 (with clamping ring correctly tightened)
Ambient air temperature	-25 to +110 °C (-13 to +230 °F)
Cabling	Solder terminals. Maximum conductor c.s.a.: 1 mm <sup>2</sup> . Cable gland: n° 13 metal (Pg 13.5). Clamping capacity: 9 to 12 mm.
LED indicators	-
Nominal voltage	~ 60 V, --- 75 V
Nominal current	7.5 A
Insulation resistance	> 10 <sup>16</sup> Ω
Contact resistance	≤ 5 mΩ

### Dimensions

**XZCC23FDM190S**

**XZCC23FCM190S**

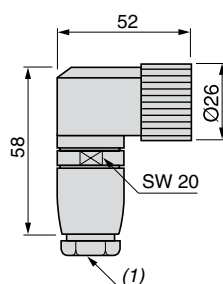
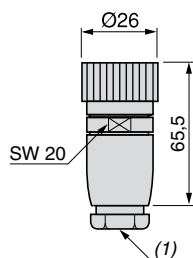

(1) Cable gland: n° 13 metal (Pg 13.5).

### Connections

**XZCC23F●M190S**

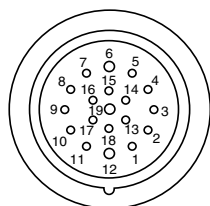

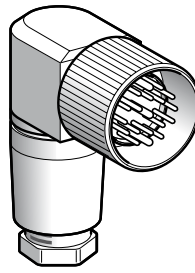
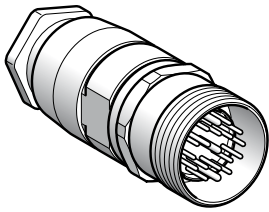

Male, M23, straight

Male, M23, elbowed (compatible with enclosure feed-throughs ABE 7ACC82)

19

Solder terminals

**XZCC23MDM190S**

**XZCC23MCM190S**

0.080 (0.18)

0.150 (0.33)

Screw threaded (metal clamping ring)

IP65 (with clamping ring correctly tightened)

-25 to +110 °C (-13 to +230 °F)

Solder terminals.  
Maximum conductor c.s.a.: 1 mm<sup>2</sup>.  
Cable gland: n° 13 metal (Pg 13.5).  
Clamping capacity: 9 to 12 mm.

-

~ 60 V, --- 75 V

7.5 A

> 10<sup>16</sup> Ω

≤ 5 mΩ

**XZCC23MDM190S**

**XZCC23MCM190S**

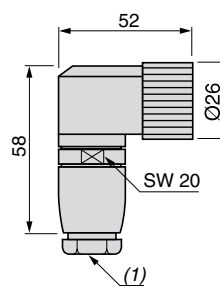
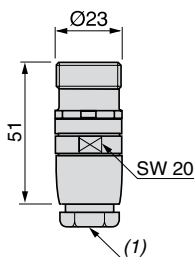

(1) Cable gland: n° 13 metal (Pg 13.5).

**XZCC23M●M190S**

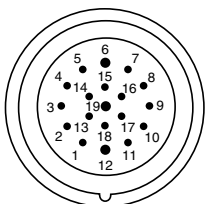

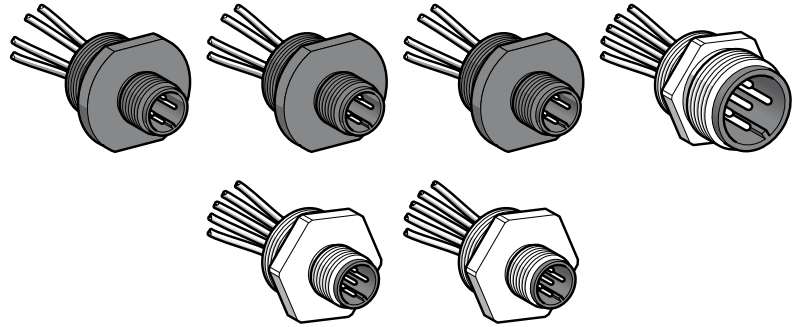

Type of 5-pin connector	M12, male		7/8"-16UN, male
Size of tapped hole	11 (Pg 11)	13 (Pg 13.5)	M20 x 1.5

### Catalog numbers

4-wire connector adapters, plastic body	XZCE11P124M	XZCE13P124M	XZCE03P124M	–
5-wire connector adapters, metal body	–	XZCE13M125M	XZCE03M125M	XZCE13M785M
Weight, kg (lb)	0.020 (0.04)	0.020 (0.04) (4-wire), 0.025 (0.06) (5-wire)		0.050 (0.11)

### Specifications

Connection type	Screw threaded		
Degree of protection	IP67		
Ambient air temperature	–25 to +80 °C (–13 to +176 °F)		
Cabling	Via 100 mm (3.94 in.) long wires		
Conductor c.s.a.	4 x 0.34 mm <sup>2</sup>	XZCE●3P124M: 4 x 0.34 mm <sup>2</sup> XZCE●3M125M: 4 x 0.34 mm <sup>2</sup> + 1 x 0.5 mm <sup>2</sup>	5 x 1 mm <sup>2</sup>
Nominal voltage	~ 250 V, ≐ 300 V	XZCE●3P124M: ~ 250 V, ≐ 300 V XZCE●3M125M: ~ 30 V, ≐ 36 V	~ 250 V, ≐ 300 V
Nominal current	4 A		6 A
Insulation resistance	> 10 <sup>9</sup> Ω		
Contact resistance	≤ 5 mΩ		

### Dimensions

XZCE11P124M	XZCE●3P124M	XZCE●3M125M	XZCE13M785M
-------------	-------------	-------------	-------------

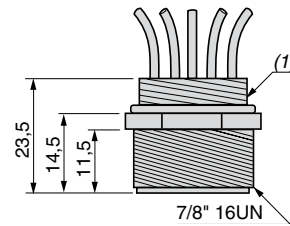
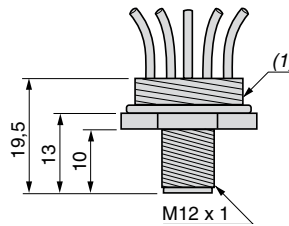
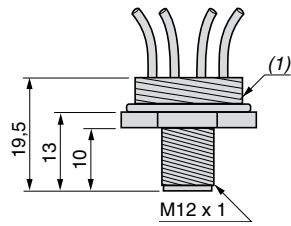
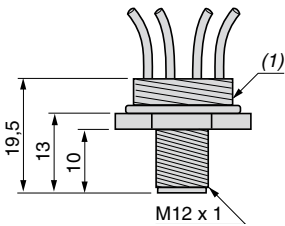

(1) Thread size 11.

(1) Thread size 13 or M20 x 1.5.

(1) Thread size 13 or M20 x 1.5.

(1) Thread size 13.

### Connections

XZCE●●P124M	XZCE●●P125M	XZCE13M785M
-------------	-------------	-------------

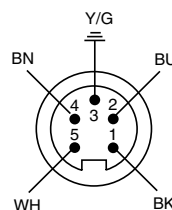
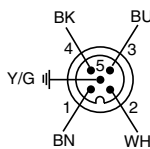
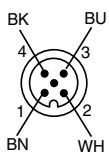



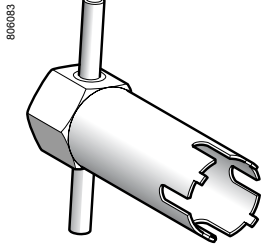

XZCG0223



XZLG102

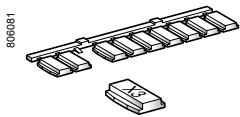

XZLG101

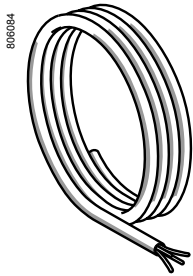

XZCB4L



DE9RA1012

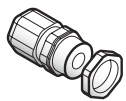

DE9PEM20010

### Accessories

Description	Unit catalog number	Weight kg (lb)
<b>Mounting tool</b> for M23 connector	<b>XZCG0223</b>	0.120 (0.26)
<b>Blanking plugs</b> for M12 female connectors (Sold in lots of 10)	<b>XZLG102</b>	0.005 (0.01)
<b>Markers for splitter boxes</b> (Strips of 10 units)	<b>XZLG101</b>	0.010 (0.02)
<b>PvR cables, 4 x 0.5 mm<sup>2</sup></b> (see specifications, page 13)	25 m (82.0 ft) <b>XZCB4L0025</b>	1.115 (2.46)
	50 m (164.0 ft) <b>XZCB4L0050</b>	2.220 (4.89)
	100 m (328.1 ft) <b>XZCB4L0100</b>	4.490 (9.90)

### Conduit adapters

Description	Threaded outside sleeve	Tapped inside sleeve	Mounting nut?	Sold in lots of	Material	Catalog number	Weight kg (lb)
Cable gland	Pg 13.5	Rubber grommet	Y	10	Plastic	<b>DE9PEM20010</b>	0.01 (0.02)
Conduit adapter	CM10 (Pg 11)	1/2"-14 NPT	N	1	Zamak	<b>DE9RA1012</b>	0.11 (0.24)
Conduit adapter	CM10 (Pg 11)	1/2"-14 NPT	Y	10	Zamak	<b>DE9RA10121</b>	0.11 (0.24)
Conduit adapter	CM12 (Pg 13.5)	1/2"-14 NPT	N	10	Zamak	<b>DE9RA1212</b>	0.11 (0.24)
Conduit adapter	CM12 (Pg 13.5)	1/2"-14 NPT	Y	10	Zamak	<b>DE9RA12121</b>	0.11 (0.24)
Conduit adapter	CM20	1/2"-14 NPT	N	10	Zamak	<b>DE9RA2012</b>	0.11 (0.24)

The **DE9RA** series of conduit adapters are made of Zamak and come with rubber grommet to provide a watertight seal. No tools are required to mount the adapter to a threaded hole, since the DE9 has a knurled round outer shape to allow for hand-tightening. An optional mounting nut is available so you can use the adapters with devices that have blank, unthreaded metric holes.

The **DE9PEM** style is a plastic cable gland used to fasten a cable to a device with an unthreaded hole. Rubber grommets create a watertight seal between the device and the cable.

# IP67 passive splitter boxes

## Telefast™ ABE9 splitter boxes

### Introduction

Passive ABE9 splitter boxes for M12 connectors make it possible to eliminate long and difficult cabling operations. Due their modularity and their dimensions, they are the ideal solution for a wide variety of customer applications.

Connection to the processing unit can be made either by connector or by multicore cable of different lengths.

IP67 protection allows these products to be used within processes or machines in harsh environments (splashing water, oil, dust, etc.).

The splitter boxes, available in 4 or 8 channel versions, allow connection of up to 16 signals maximum, depending on the version (2 per channel).

The specifications of ABE9 splitter boxes C12 are as follows:

- Connection of sensors and actuators using M12, 5-pin connectors.

- Modularity: 4 or 8 channels.

- Mounting system and connection to the processing unit conforming to market standards:

- mounting centers,

- M23, 19-pin connector, enabling the use of pre-formed cables in order to reduce installation time and the risk of error,

- multicore cable, 5 or 10 m. The splitter box, consisting of a connection cover fitted with plug-in terminals, provides considerable flexibility for:

- the replacement of damaged parts,

- modification of cable length.

Base units ABE9C12●●L●● enable the use of 2 separate commons which, for example, can be used for the management of an emergency stop. This function is accessible beneath the terminal cover using 2 removable links. If both links are removed, the 2 supplies become independent.

The use of a Y-connector allows 2 signals to be connected to the same M12 channel on the splitter box.

Example: splitter box ABE9C1281 (8 channels) enables the connection of 16 signals to the processing unit.

The Y-connector is available in 2 versions:

- M12-M12 for connection of two M12 connectors to a single M12 channel on the splitter box,

- M8-M12 for connection of two M8 connectors to a single M12 channel on the splitter box.

Complete catalog number	=	Splitter box only	+	Connector with cable
ABE9C1240L05	=	ABE9C1240M	+	ABE9XCA1405
ABE9C1240L10	=	ABE9C1240M	+	ABE9XCA1410
ABE9C1241L05	=	ABE9C1241M	+	ABE9XCA1405
ABE9C1241L10	=	ABE9C1241M	+	ABE9XCA1410
ABE9C1280L05	=	ABE9C1280M	+	ABE9XCA1805
ABE9C1280L10	=	ABE9C1280M	+	ABE9XCA1810
ABE9C1281L05	=	ABE9C1281M	+	ABE9XCA1805
ABE9C1281L10	=	ABE9C1281M	+	ABE9XCA1810

### Connector only

ABE9CM12C

# IP67 passive splitter boxes

Telefast™ ABE9 splitter boxes

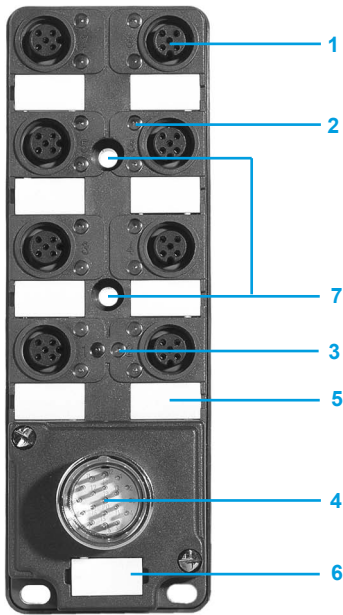

## Description

Passive ABE9 splitter boxes C12●●C23 have the following on the front face:

- 1 4 or 8 M12 female connectors (depending on the model) for connection of sensors and actuators (2 channels per connector).
- 2 8 or 16 channel status indicator lights (depending on the model).
- 3 1 Power On indicator light on the splitter box (depending on the model).
- 4 1 M23, 19-pin male connector.
- 5 4 or 8 channel marker labels.
- 6 1 splitter box marker label.
- 7 Splitter box mounting holes.

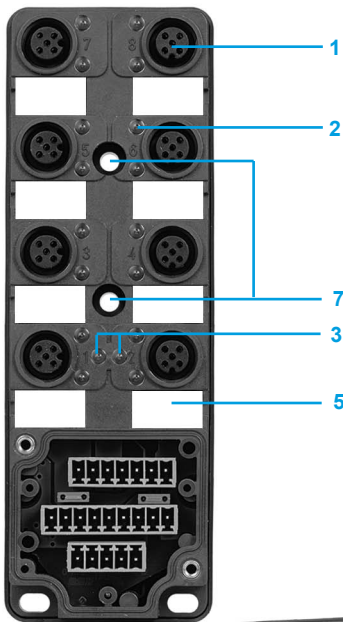

Passive ABE9 splitter boxes C12●●L●● have the following on the front face:

- 1 4 or 8 M12 female connectors (depending on the model) for connection of sensors and actuators (2 channels per connector).
- 2 8 or 16 channel status indicator lights (depending on the model).
- 3 2 Power On indicator lights on the splitter box (depending on the model).
- 4 1 removable connection cover fitted with plug-in terminals.
- 5 4 or 8 channel marker labels.
- 6 1 splitter box marker label.
- 7 Splitter box mounting holes.

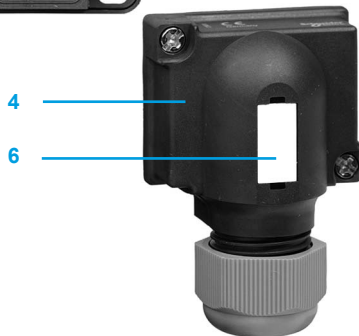

Splitter box type		ABE9C12●0C23	ABE9C12●1C23	ABE9C12●0L●●, ABE9C12●0M	ABE9C12●1L●●, ABE9C12●1M
<b>Environmental specifications</b>					
Product certifications		cULus			
Temperature	Operation	°C (°F)	- 20 to +80 (- 4 to +176)		
	Storage	°C (°F)	- 40 to +85 (- 40 to +185)		
Degree of protection	Conforming to IEC 529		IP67		
Vibration resistance	Conforming to IEC 68-2-6, test Fc	Hz	10–57 (constant amplitude = 1.5 mm) 57–150 (constant acceleration = 0.20 gn)		
Shock resistance	Conforming to IEC/EN 68-2-2		30 gn, 11 ms		
Insulation group	VDE 0110		Category 3		
Mounting			All positions		
Mechanical mounting			M4 screw mounting		
<b>Channel specifications</b>					
Number of channels		4 or 8 (depending on the model)			
Type of connection per channel		M12, 5-pin female connectors			
Nominal voltage		~ V	24		
Current per channel		A	4 maximum		
Contact resistance		m Ω	5		
Power supply status indication		–	Green LED	–	Green LED
Channel status indication		–	Yellow LED	–	Yellow LED
<b>Connection specifications</b>					
Type of connection		M23, 19-pin male connector	Multicore cable		
Total current in commons	1 mm <sup>2</sup> supply wire	A	16		
	0.75 mm <sup>2</sup> supply wire	A	12		
Separation of commons		Without	Without or with (by removing links BR1 and BR2)		

### Substitution table

Old range	New range
<b>Splitter boxes with connection by M23 connector</b>	
XZLC1241C3	ABE9C1241C23
XZLC1240C3	ABE9C1240C23
XZLC1281C3	ABE9C1281C23
XZLC1280C3	ABE9C1280C23
<b>Splitter boxes with connection by cable</b>	
XZLC1241L5	ABE9C1241L05
XZLC1240L5	ABE9C1240L05
XZLC1241L10	ABE9C1241L10
XZLC1240L10	ABE9C1240L10
XZLC1281L5	ABE9C1281L05
XZLC1280L5	ABE9C1280L05
XZLC1281L10	ABE9C1281L10
XZLC1280L10	ABE9C1280L10
<b>Accessories</b>	
XZLG102	FTXCM12B
XZLC1220C1	FTXCY1212



ABE9C124●C2:



ABE9C128●C2



ABE9C124●L●



ABE9C128●L●



ABE9C128●M



ABE9XCA1●●



### Catalog Numbers

#### Splitter boxes with connection by M23 connector

Number of channels	Connection by	LED indicator	Catalog number	Weight kg (lb)
4	4 x M12 female connectors	With	ABE9C1241C23	0.080 (0.200)
		Without	ABE9C1240C23	0.080 (0.200)
8	8 x M12 female connectors	With	ABE9C1281C23	0.140 (0.300)
		Without	ABE9C1280C23	0.140 (0.300)

#### Splitter boxes with connection by cable

Number of channels	Connection by	Length m	LED indicator	Catalog number	Weight kg (lb)
4	4 x M12 female connectors	5	With	ABE9C1241L05	0.680 (1.500)
			Without	ABE9C1240L05	0.680 (1.500)
		10	With	ABE9C1241L10	1.700 (3.700)
			Without	ABE9C1240L10	1.700 (3.700)
8	8 x M12 female connectors	5	With	ABE9C1281L05	1.610 (3.500)
			Without	ABE9C1280L05	1.610 (3.500)
		10	With	ABE9C1281L10	3.060 (6.700)
			Without	ABE9C1280L10	3.060 (6.700)

#### Splitter boxes only, M12

Number of channels	For use with connector terminal	with cable	LED indicator	Catalog number	Weight kg (lb)
4	ABE9CM12C	ABE9XCA14●●	With	ABE9C1241M	0.060 (0.100)
			Without	ABE9C1240M	0.060 (0.100)
8	ABE9CM12C	ABE9XCA18●●	With	ABE9C1281M	0.100 (0.200)
			Without	ABE9C1280M	0.100 (0.200)

#### Separate components

Type	No. of channels	For use with splitter box	Length m	Catalog number	Weight kg (lb)
Terminal block connector (1)	-	ABE9C124●M	-	ABE9CM12C	0.040 (0.088)
		ABE9C128●M	-	ABE9CM12C	0.040 (0.088)
Connectors with cable	4	ABE9C124●M	5	ABE9XCA1405	1.060 (2.300)
			10	ABE9XCA1410	2.080 (4.600)
	8	ABE9C128●M	5	ABE9XCA1805	1.510 (3.300)
			10	ABE9XCA1810	2.240 (4.900)

#### Accessories

Description	Composition	Catalog number	Weight kg (lb)
Sealing plugs	For M8 connector (lot of 10)	FTX CM08B	0.100 (0.200)
	For M12 connector (lot of 10)	FTX CM12B	0.100 (0.200)
Y-connectors	Connection of 2 x M8 connectors to M12 connector on splitter box	FTX CY1208	0.020 (0.044)
	Connection of 2 x M12 connectors to M12 connector on splitter box	FTX CY1212	0.030 (0.066)
Marker labels	Lot of 12	ABE9XLA10	-

(1) To be cabled by user.

## Dimensions

ABE9C124●C23

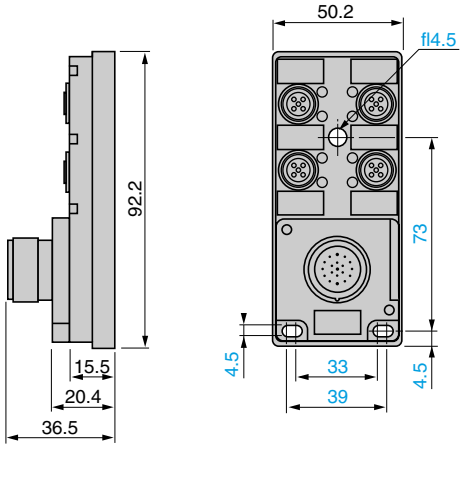

ABE9C124●L●●

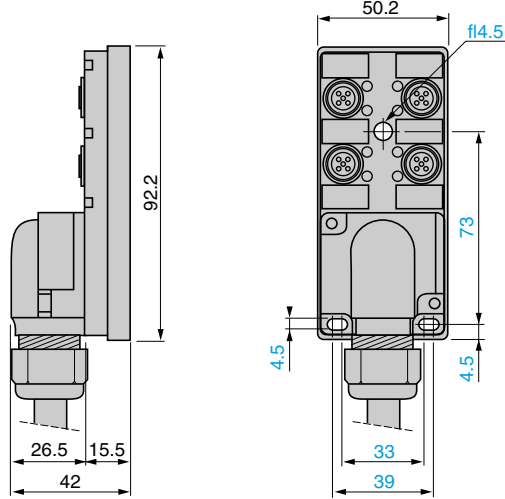

ABE9C128●C23

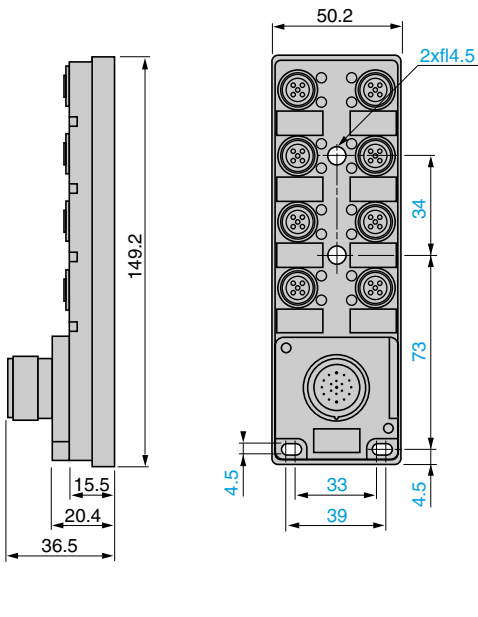

ABE9C128●L●●

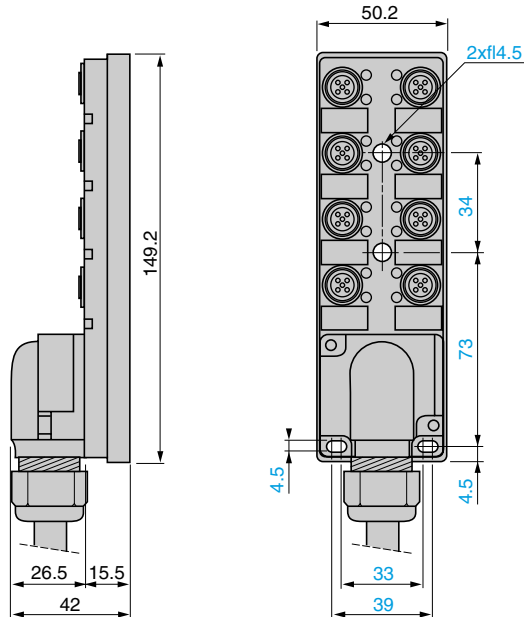

FTX CY1208

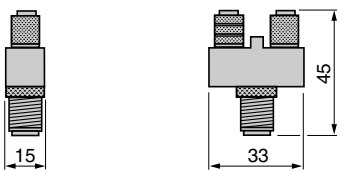

FTX CY1212

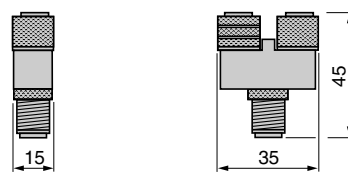

## Y-connector connection

FTX CY1208

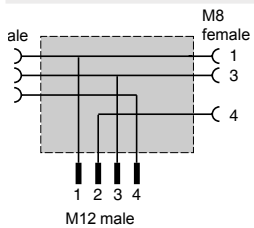

FTX CY1212

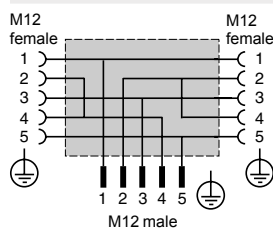

### ABE9C124●C23

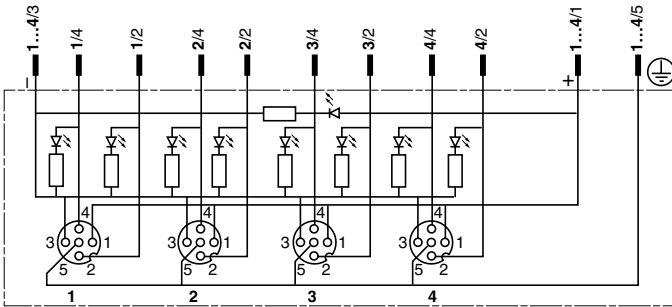

Item	Contact
1/4	15
1/2	7
2/4	5
2/2	4
3/4	16
3/2	8
4/4	3
4/2	14
1 and 3/1	19
2 and 4/1	19
1 and 3/3	6
2 and 4/3	6
1 to 4/5	12

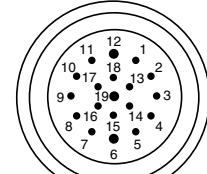

M23 connector

### ABE9C128●C23

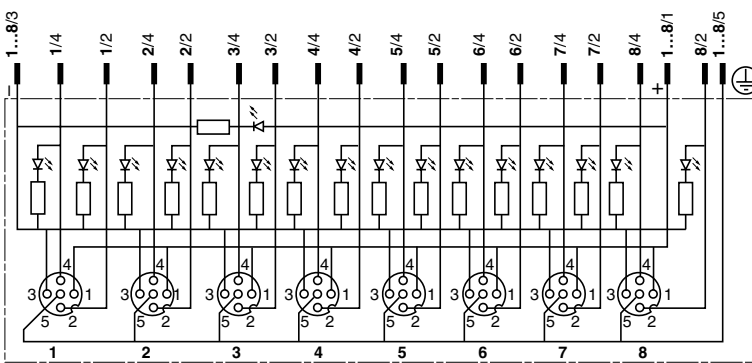

Item	Contact
1/4	15
1/2	7
2/4	5
2/2	4
3/4	16
3/2	8
4/4	3
4/2	14
5/4	17
5/2	9
6/4	2
6/2	13
7/4	11
7/2	10
8/4	1
8/2	18
1, 3, 5 & 7/1	19
2, 4, 6 & 8/1	19
1, 3, 5 & 7/3	6
2, 4, 6 & 8/3	6
1 to 8/5	12

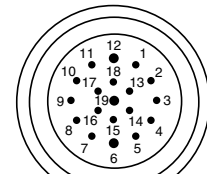

M23 connector

### ABE9C124●L●●

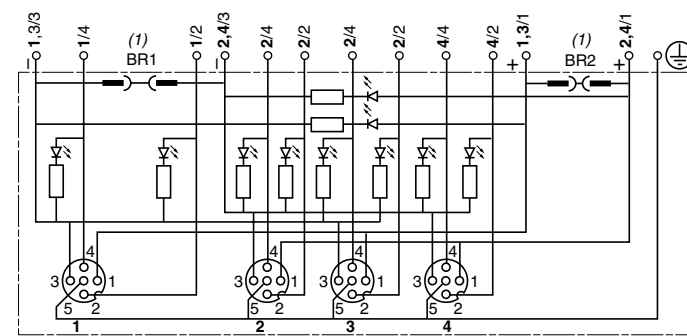

Item	Terminal	Wire
1/4	1	White
1/2	9	Gray/pink
2/4	2	Green
2/2	10	Red/blue
3/4	3	Yellow
3/2	11	White/green
4/4	4	Gray
4/2	12	Brown/green
1 and 3/1	+1	Brown 1
2 and 4/1	+2	Brown 2
1 and 3/3	-1	Blue 1
2 and 4/3	-2	Blue 2
1 to 4/5	PE	Green/yellow

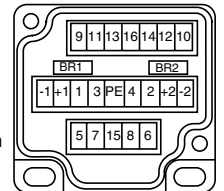

(1) BR1 and BR2: removable link.

### ABE9C128●L●●

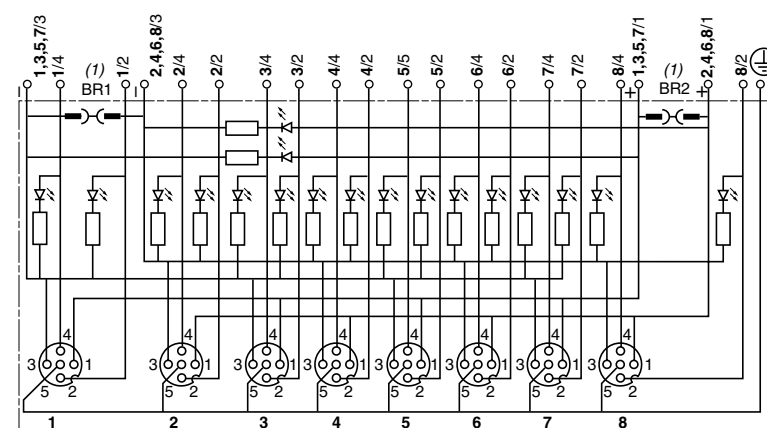

Item	Terminal	Wire
1/4	1	White
1/2	9	Gray/pink
2/4	2	Green
2/2	10	Red/blue
3/4	3	Yellow
3/2	11	White/green
4/4	4	Gray
4/2	12	Brown/green
5/4	5	Pink
5/2	13	White/yellow
6/4	6	Red
6/2	14	Yellow/brown
7/4	7	Black
7/2	15	White/gray
8/4	8	Violet
8/2	16	Gray/brown
1, 3, 5 & 7/1	+1	Brown 1
2, 4, 6 & 8/1	+2	Brown 2
1, 3, 5 & 7/3	-1	Blue 1
2, 4, 6 & 8/3	-2	Blue 2
1 to 8/5	PE	Green/yellow

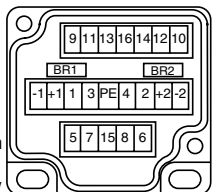

(1) BR1 and BR2: removable links.

Telemecanique Sensors

[www.tesensors.com](http://www.tesensors.com)

**Schneider Electric USA, Inc.**  
1875 Founders Drive  
Dayton, Ohio 45420  
(800) 435-2121  
[www.tesensors.us](http://www.tesensors.us)

**Schneider Electric  
Canada, Inc.**  
5985 McLaughlin Road  
Mississauga, Ontario L5R 1B8  
(800) 435-2121  
[www.tesensors.ca](http://www.tesensors.ca)

The information provided in this documentation contains general descriptions and/or technical characteristics of the performance of the products contained herein. This documentation is not intended as a substitute for and is not to be used for determining suitability or reliability of these products for specific user applications. It is the duty of any such user or integrator to perform the appropriate and complete risk analysis, evaluation and testing of the products with respect to the relevant specific application or use thereof. Neither Schneider Electric nor any of its affiliates or subsidiaries shall be responsible or liable for misuse of the information contained herein.

9006CT1208

© 2012 Schneider Electric. All Rights Reserved.





## Стандарт Электрон Связь

Мы молодая и активно развивающаяся компания в области поставок электронных компонентов. Мы поставляем электронные компоненты отечественного и импортного производства напрямую от производителей и с крупнейших складов мира.

Благодаря сотрудничеству с мировыми поставщиками мы осуществляем комплексные и плановые поставки широчайшего спектра электронных компонентов.

Собственная эффективная логистика и склад в обеспечивает надежную поставку продукции в точно указанные сроки по всей России.

Мы осуществляем техническую поддержку нашим клиентам и предпродажную проверку качества продукции. На все поставляемые продукты мы предоставляем гарантию .

Осуществляем поставки продукции под контролем ВП МО РФ на предприятия военно-промышленного комплекса России , а также работаем в рамках 275 ФЗ с открытием отдельных счетов в уполномоченном банке. Система менеджмента качества компании соответствует требованиям ГОСТ ISO 9001.

Минимальные сроки поставки, гибкие цены, неограниченный ассортимент и индивидуальный подход к клиентам являются основой для выстраивания долгосрочного и эффективного сотрудничества с предприятиями радиоэлектронной промышленности, предприятиями ВПК и научно-исследовательскими институтами России.

С нами вы становитесь еще успешнее!

### Наши контакты:

**Телефон:** +7 812 627 14 35

**Электронная почта:** [sales@st-electron.ru](mailto:sales@st-electron.ru)

**Адрес:** 198099, Санкт-Петербург,  
Промышленная ул, дом № 19, литера Н,  
помещение 100-Н Офис 331