

BFP640FESD

Robust High Performance Low Noise Bipolar RF Transistor

Data Sheet

Revision 1.1, 2010-06-29

Edition 2010-06-29

**Published by
Infineon Technologies AG
81726 Munich, Germany**

**© 2010 Infineon Technologies AG
All Rights Reserved.**

Legal Disclaimer

The information given in this document shall in no event be regarded as a guarantee of conditions or characteristics. With respect to any examples or hints given herein, any typical values stated herein and/or any information regarding the application of the device, Infineon Technologies hereby disclaims any and all warranties and liabilities of any kind, including without limitation, warranties of non-infringement of intellectual property rights of any third party.

Information

For further information on technology, delivery terms and conditions and prices, please contact the nearest Infineon Technologies Office (www.infineon.com).

Warnings

Due to technical requirements, components may contain dangerous substances. For information on the types in question, please contact the nearest Infineon Technologies Office.

Infineon Technologies components may be used in life-support devices or systems only with the express written approval of Infineon Technologies, if a failure of such components can reasonably be expected to cause the failure of that life-support device or system or to affect the safety or effectiveness of that device or system. Life support devices or systems are intended to be implanted in the human body or to support and/or maintain and sustain and/or protect human life. If they fail, it is reasonable to assume that the health of the user or other persons may be endangered.

BFP640FESD, Robust High Performance Low Noise Bipolar RF Transistor

Revision History: 2010-06-29, Revision 1.1

Previous Revision Rev.1.0:

Page	Subjects (major changes since last revision)
10	PRFIn value added
18-21	Characteristic DC diagrams and OIP3 diagram added

Trademarks of Infineon Technologies AG

BlueMoon™, COMNEON™, C166™, CROSSAVE™, CanPAK™, CIPOS™, CoolMOS™, CoolSET™, CORECONTROL™, DAVE™, EasyPIM™, EconoBRIDGE™, EconoDUAL™, EconoPACK™, EconoPIM™, EiceDRIVER™, EUPEC™, FCOS™, HITFET™, HybridPACK™, ISOFACE™, I²RF™, IsoPACK™, MIPAQ™, ModSTACK™, my-d™, NovalithIC™, OmniTune™, OptiMOS™, ORIGA™, PROFET™, PRO-SIL™, PRIMARION™, PrimePACK™, RASIC™, ReverSave™, SatRIC™, SensoNor™, SIEGET™, SINDRION™, SMARTi™, SmartLEWIS™, TEMPFET™, thinQ!™, TriCore™, TRENCHSTOP™, X-GOLD™, XMM™, X-PMU™, XPOSYS™.

Other Trademarks

Advance Design System™ (ADS) of Agilent Technologies, AMBA™, ARM™, MULTI-ICE™, PRIMECELL™, REALVIEW™, THUMB™ of ARM Limited, UK. AUTOSAR™ is licensed by AUTOSAR development partnership. Bluetooth™ of Bluetooth SIG Inc. CAT-iq™ of DECT Forum. COLOSSUS™, FirstGPS™ of Trimble Navigation Ltd. EMV™ of EMVCo, LLC (Visa Holdings Inc.). EPCOS™ of Epcos AG. FLEXGO™ of Microsoft Corporation. FlexRay™ is licensed by FlexRay Consortium. HYPERTERMINAL™ of Hilgraeve Incorporated. IEC™ of Commission Electrotechnique Internationale. IrDA™ of Infrared Data Association Corporation. ISO™ of INTERNATIONAL ORGANIZATION FOR STANDARDIZATION. MATLAB™ of MathWorks, Inc. MAXIM™ of Maxim Integrated Products, Inc. MICROTEC™, NUCLEUS™ of Mentor Graphics Corporation. Mifare™ of NXP. MIPI™ of MIPI Alliance, Inc. MIPS™ of MIPS Technologies, Inc., USA. muRata™ of MURATA MANUFACTURING CO., MICROWAVE OFFICE™ (MWO) of Applied Wave Research Inc., OmniVision™ of OmniVision Technologies, Inc. Openwave™ Openwave Systems Inc. RED HAT™ Red Hat, Inc. RFMD™ RF Micro Devices, Inc. SIRIUS™ of Sirius Sattelite Radio Inc. SOLARIS™ of Sun Microsystems, Inc. SPANSION™ of Spansion LLC Ltd. Symbian™ of Symbian Software Limited. TAIYO YUDEN™ of Taiyo Yuden Co. TEAKLITE™ of CEVA, Inc. TEKTRONIX™ of Tektronix Inc. TOKO™ of TOKO KABUSHIKI KAISHA TA. UNIX™ of X/Open Company Limited. VERILOG™, PALLADIUM™ of Cadence Design Systems, Inc. VLYNQ™ of Texas Instruments Incorporated. VXWORKS™, WIND RIVER™ of WIND RIVER SYSTEMS, INC. ZETEX™ of Diodes Zetex Limited.

Last Trademarks Update 2010-03-22

Table of Contents

	Table of Contents	4
	List of Figures	5
	List of Tables	6
1	Features	7
2	Product Brief	8
3	Maximum Ratings	10
4	Thermal Characteristics	11
5	Electrical Characteristics	12
5.1	DC Characteristics	12
5.2	General AC Characteristics	12
5.3	Frequency Dependent AC Characteristics	13
5.4	Characteristic DC Diagrams	18
5.5	Characteristic AC Diagrams	21
6	Simulation Data	27
7	Package Information TSFP-4-1	28

List of Figures

Figure 1	Total Power Dissipation $P_{tot} = f(T_s)$	11
Figure 2	BFP640FESD Testing Circuit	13
Figure 3	Collector Current vs. Collector Emitter Voltage $I_C = f(V_{CE}), I_B = \text{Parameter}$	18
Figure 4	DC Current Gain $h_{FE} = f(I_C), V_{CE} = 3 \text{ V}$	18
Figure 5	Collector Current vs. Base-Emitter Voltage $I_C = f(V_{BE}), V_{CE} = 2 \text{ V}$	19
Figure 6	Base Current vs. Base Emitter Forward Voltage $I_B = f(V_{BE}), V_{CE} = 2 \text{ V}$	19
Figure 7	Base Current vs. Base Emitter Reverse Voltage $I_B = f(V_{EB}), V_{CE} = 2 \text{ V}$	20
Figure 8	Transition Frequency $f_T = f(I_C), f = 1 \text{ GHz}, V_{CE} = \text{Parameter}$	21
Figure 9	3rd Order Intercept Point $OIP_3 = f(I_C), Z_S = Z_L = 50 \Omega, V_{CE}, f = \text{Parameters}$	21
Figure 10	Collector Base Capacitance $C_{CB} = f(V_{CB}), f = 1 \text{ MHz}$	22
Figure 11	Gain $G_{ma}, G_{ms}, S_{21} ^2 = f(f), V_{CE} = 3 \text{ V}, I_C = 30 \text{ mA}$	22
Figure 12	Maximum Power Gain $G_{max} = f(I_C), V_{CE} = 3 \text{ V}, f = \text{Parameter in GHz}$	23
Figure 13	Maximum Power Gain $G_{max} = f(V_{CE}), I_C = 30 \text{ mA}, f = \text{Parameter in GHz}$	23
Figure 14	Input Matching $S_{11} = f(f), V_{CE} = 3 \text{ V}, I_C = 6 / 30 \text{ mA}$	24
Figure 15	Source Impedance for Minimum Noise Figure $Z_{opt} = f(f), V_{CE} = 3 \text{ V}, I_C = 6 / 30 \text{ mA}$	24
Figure 16	Output Matching $S_{22} = f(f), V_{CE} = 3 \text{ V}, I_C = 6 / 30 \text{ mA}$	25
Figure 17	Noise Figure $NF_{min} = f(f), V_{CE} = 3 \text{ V}, I_C = 6 / 30 \text{ mA}, Z_S = Z_{opt}$	25
Figure 18	Noise Figure $NF_{min} = f(I_C), V_{CE} = 3 \text{ V}, Z_S = Z_{opt}, f = \text{Parameter in GHz}$	26
Figure 19	Noise Figure $NF_{50} = f(\text{freq}), V_{CE} = 3 \text{ V}, Z_S = 50 \Omega, f = \text{Parameter in GHz}$	26
Figure 20	Package Outline	28
Figure 21	Package Foot Print	28
Figure 22	Marking Description (Marking BFP640FESD: T4s)	28
Figure 23	Tape Dimensions	28

List of Tables

Table 1	Quick Reference DC Characteristics at $T_A = 25^\circ\text{C}$	8
Table 2	Quick Reference AC Characteristics at $T_A = 25^\circ\text{C}$	9
Table 3	Maximum Ratings at $T_A = 25^\circ\text{C}$ (unless otherwise specified).....	10
Table 4	Thermal Resistance	11
Table 5	DC Characteristics at $T_A = 25^\circ\text{C}$	12
Table 6	General AC Characteristics at $T_A = 25^\circ\text{C}$	12
Table 7	AC Characteristics, $V_{CE} = 3\text{ V}$, $f = 150\text{ MHz}$	13
Table 8	AC Characteristics, $V_{CE} = 3\text{ V}$, $f = 450\text{ MHz}$	14
Table 9	AC Characteristics, $V_{CE} = 3\text{ V}$, $f = 900\text{ MHz}$	14
Table 10	AC Characteristics, $V_{CE} = 3\text{ V}$, $f = 1.5\text{ GHz}$	15
Table 11	AC Characteristics, $V_{CE} = 3\text{ V}$, $f = 1.9\text{ GHz}$	15
Table 12	AC Characteristics, $V_{CE} = 3\text{ V}$, $f = 2.4\text{ GHz}$	16
Table 13	AC Characteristics, $V_{CE} = 3\text{ V}$, $f = 3.5\text{ GHz}$	16
Table 14	AC Characteristics, $V_{CE} = 3\text{ V}$, $f = 5.5\text{ GHz}$	17
Table 15	AC Characteristics, $V_{CE} = 3\text{ V}$, $f = 10\text{ GHz}$	17

1 Features

- Robust high performance low noise amplifier based on Infineon’s reliable, high volume SiGe:C wafer technology
- 2 kV ESD robustness (HBM) due to integrated protection circuits
- High maximum RF input power of 21 dBm
- 0.6 dB minimum noise figure typical at 1.5 GHz, 0.65 dB at 2.4 GHz, 6 mA
- 28.5 dB maximum gain G_{ms} typical at 1.5 GHz, 25 dB at 2.4 GHz, 30 mA
- 26 dBm OIP_3 typical at 2.4 GHz, 30 mA
- Accurate SPICE GP model available to enable effective design in process (see chapter 6)
- Thin, small, flat, Pb- and halogen free (RoHS compliant) package with visible leads

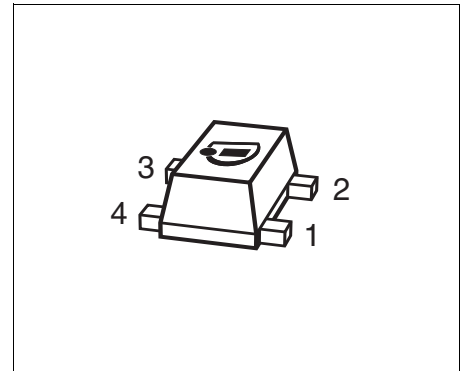

Applications

As Low Noise Amplifier (LNA) in

- Mobile, portable and fixed connectivity applications: WLAN 802.11a/b/g/n, WiMax 2.5/3.5/5GHz, UWB, Bluetooth
- Satellite communication systems: Navigation systems (GPS, Glonass), satellite radio (SDARs, DAB) and C-band LNB
- Multimedia applications such as mobile/portable TV, CATV, FM radio
- 3G/4G UMTS/LTE mobile phone applications
- ISM applications like RKE, AMR and Zigbee, as well as for emerging wireless applications.

As discrete active mixer, amplifier in VCOs and buffer amplifier

Attention: ESD (Electrostatic discharge) sensitive device, observe handling precautions

Product Name	Package	Pin Configuration				Marking
BFP640FESD	TSFP-4-1	1 = B	2 = E	3 = C	4 = E	T4s

2 Product Brief

The BFP640FESD is a Silicon Germanium Carbon (SiGe:C) NPN Heterojunction wideband Bipolar RF Transistor (HBT) in a plastic thin small flat 4-pin dual emitter package with visible leads. The device is fitted with internal protection circuits, which enhance robustness against ESD and high RF input power strongly. The device combines robustness with very high RF gain and lowest noise figure at low operation current for use in a wide range of wireless applications.

The BFP640FESD is especially well-suited for portable battery-powered applications in which reduced power consumption is a key requirement. Device design supports collector voltages up to 4.1 V.

Table 1 Quick Reference DC Characteristics at $T_A = 25^\circ\text{C}$

Parameter	Symbol	Values			Unit	Note / Test Condition
		Min.	Typ.	Max.		
Collector emitter breakdown voltage	$V_{(BR)CEO}$	4.1	4.7	–	V	$I_C = 1 \text{ mA}, I_B = 0$
Collector base leakage current	I_{CBO}	–	–	500	nA	$V_{CB} = 2 \text{ V}, I_E = 0$ Open emitter
DC current gain	h_{FE}	110	180	270		$V_{CE} = 3 \text{ V}, I_C = 30 \text{ mA}$
Collector current	I_C	–	–	50	mA	
Total power dissipation	P_{tot}	–	–	200	mW	$T_S \leq 90^\circ\text{C}$

Table 2 Quick Reference AC Characteristics at $T_A = 25^\circ\text{C}$

Parameter	Symbol	Values			Unit	Note / Test Condition
		Min.	Typ.	Max.		
Transition frequency	f_T	–	46	–	GHz	$V_{CE} = 3\text{ V}, I_C = 30\text{ mA}$ $f = 1\text{ GHz}$
$V_{CE} = 3\text{ V}, f = 1.5\text{ GHz}$						
Maximum Power Gain						
Low noise operation point	G_{ms}	–	24	–	dB	$I_C = 6\text{ mA}$
High linearity operation point	G_{ms}	–	28.5	–		$I_C = 30\text{ mA}$
Transducer Gain						
Low noise operation point	S_{21}	–	21.5	–	dB	$Z_S = Z_L = 50\ \Omega$ $I_C = 6\text{ mA}$
High linearity operation point	S_{21}	–	25.5	–		$I_C = 30\text{ mA}$
Minimum Noise Figure						
Minimum noise figure	NF_{min}	–	0.6	–	dB	$Z_S = Z_{opt}$ $I_C = 6\text{ mA}$
Associated gain	G_{ass}	–	22.5	–		$I_C = 6\text{ mA}$
Linearity						
1 dB gain compression point	OP_{1dB}	–	11.5	–	dBm	$Z_S = Z_L = 50\ \Omega$ $I_C = 30\text{ mA}$
3rd order intercept point	OIP_3	–	25.5	–		$I_C = 30\text{ mA}$
$V_{CE} = 3\text{ V}, f = 2.4\text{ GHz}$						
Maximum Power Gain						
Low noise operation point	G_{ms}	–	21.5	–	dB	$I_C = 6\text{ mA}$
High linearity operation point	G_{ma}	–	25	–		$I_C = 30\text{ mA}$
Transducer Gain						
Low noise operation point	S_{21}	–	18.5	–	dB	$Z_S = Z_L = 50\ \Omega$ $I_C = 6\text{ mA}$
High linearity operation point	S_{21}	–	21.5	–		$I_C = 30\text{ mA}$
Minimum Noise Figure						
Minimum noise figure	NF_{min}	–	0.65	–	dB	$Z_S = Z_{opt}$ $I_C = 6\text{ mA}$
Associated gain	G_{ass}	–	19.5	–		$I_C = 6\text{ mA}$
Linearity						
1 dB gain compression point	OP_{1dB}	–	11.5	–	dBm	$Z_S = Z_L = 50\ \Omega$ $I_C = 30\text{ mA}$
3rd order intercept point	OIP_3	–	26	–		$I_C = 30\text{ mA}$

3 Maximum Ratings

Table 3 Maximum Ratings at $T_A = 25^\circ\text{C}$ (unless otherwise specified)

Parameter	Symbol	Values		Unit	Note / Test Condition
		Min.	Max.		
Collector emitter voltage	V_{CEO}	–	4.1	V	Open base $T_A = 25^\circ\text{C}$
		–	3.6	V	$T_A = -55^\circ\text{C}$
Collector base voltage ¹⁾	V_{CBO}	–	4.8	V	Open emitter $T_A = 25^\circ\text{C}$
		–	4.3	V	$T_A = -55^\circ\text{C}$
Collector emitter voltage ²⁾	V_{CES}	–	4.1	V	Emitter / base shortened $T_A = 25^\circ\text{C}$
		–	3.6	V	$T_A = -55^\circ\text{C}$
Base current ³⁾	I_B	-10	6	mA	–
Collector current	I_C	–	50	mA	–
RF input power	P_{RFin}	–	21	dBm	–
ESD stress pulse ⁴⁾	V_{ESD}	-2	2	kV	HBM, all pins, acc. to JESD22-A114
Total power dissipation ⁵⁾	P_{tot}	–	200	mW	$T_S \leq 90^\circ\text{C}$
Junction temperature	T_J	–	150	$^\circ\text{C}$	–
Storage temperature	T_{Stg}	-55	150	$^\circ\text{C}$	–

1) Low V_{CBO} due to integrated protection circuits.

2) V_{CES} is identical to V_{CEO} due to integrated protection circuits.

3) Sustainable reverse bias current is high due to integrated protection circuits.

4) ESD robustness is high due to integrated protection circuits.

5) T_S is the soldering point temperature. T_S measured on the emitter lead at the soldering point of the pcb.

Attention: Stresses above the max. values listed here may cause permanent damage to the device. Exposure to absolute maximum rating conditions for extended periods may affect device reliability. Maximum ratings are absolute ratings; exceeding only one of these values may cause irreversible damage to the integrated circuit.

4 Thermal Characteristics

Table 4 Thermal Resistance

Parameter	Symbol	Values			Unit	Note / Test Condition
		Min.	Typ.	Max.		
Junction - soldering point ¹⁾	R_{thJS}	–	300	–	K/W	–

1) For calculation of R_{thJA} please refer to Application Note Thermal Resistance AN 077

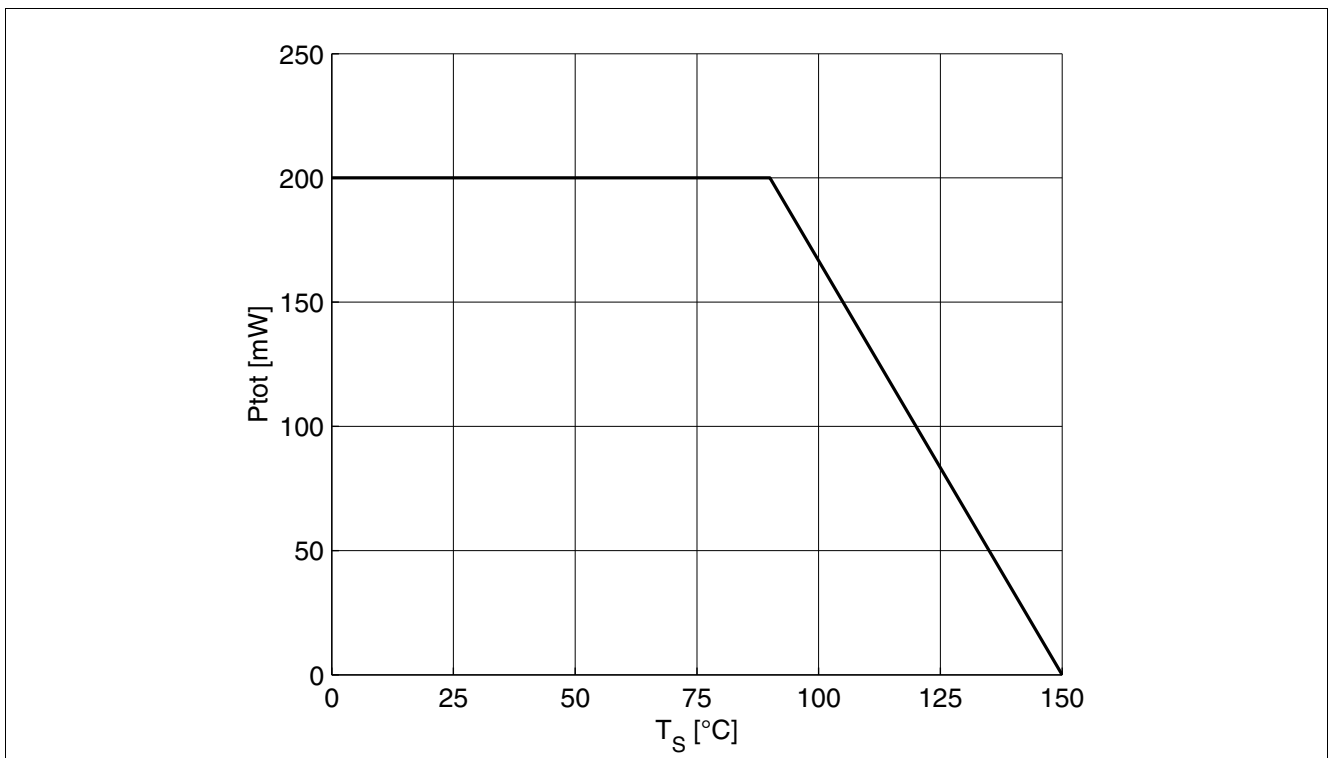

Figure 1 Total Power Dissipation $P_{tot} = f(T_s)$

5 Electrical Characteristics

5.1 DC Characteristics

Table 5 DC Characteristics at $T_A = 25\text{ °C}$

Parameter	Symbol	Values			Unit	Note / Test Condition
		Min.	Typ.	Max.		
Collector emitter breakdown voltage	$V_{(BR)CEO}$	4.1	4.7	–	V	$I_C = 1\text{ mA}$, $I_B = 0$ Open base
Collector emitter leakage current	I_{CES}	–	–	500	nA	$V_{CE} = 2\text{ V}$, $V_{BE} = 0$ Emitter/base shortened
Collector base leakage current	I_{CBO}	–	–	500	nA	$V_{CB} = 2\text{ V}$, $I_E = 0$ Open emitter
Emitter base leakage current	I_{EBO}	–	–	10	μA	$V_{EB} = 0.5\text{ V}$, $I_C = 0$ Open collector
DC current gain	h_{FE}	110	180	270		$V_{CE} = 3\text{ V}$, $I_C = 30\text{ mA}$ Pulse measured

5.2 General AC Characteristics

Table 6 General AC Characteristics at $T_A = 25\text{ °C}$

Parameter	Symbol	Values			Unit	Note / Test Condition
		Min.	Typ.	Max.		
Transition frequency	f_T	–	46	–	GHz	$V_{CE} = 3\text{ V}$, $I_C = 30\text{ mA}$, $f = 1\text{ GHz}$
Collector base capacitance	C_{CB}	–	0.08	–	pF	$V_{CB} = 3\text{ V}$, $V_{BE} = 0\text{ V}$ $f = 1\text{ MHz}$ Emitter grounded
Collector emitter capacitance	C_{CE}	–	0.35	–	pF	$V_{CE} = 3\text{ V}$, $V_{BE} = 0\text{ V}$ $f = 1\text{ MHz}$ Base grounded
Emitter base capacitance	C_{EB}	–	0.6	–	pF	$V_{EB} = 0.4\text{ V}$, $V_{CB} = 0\text{ V}$ $f = 1\text{ MHz}$ Collector grounded

5.3 Frequency Dependent AC Characteristics

Measurement setup is a test fixture with Bias T's in a $50\ \Omega$ system, $T_A = 25\ ^\circ\text{C}$

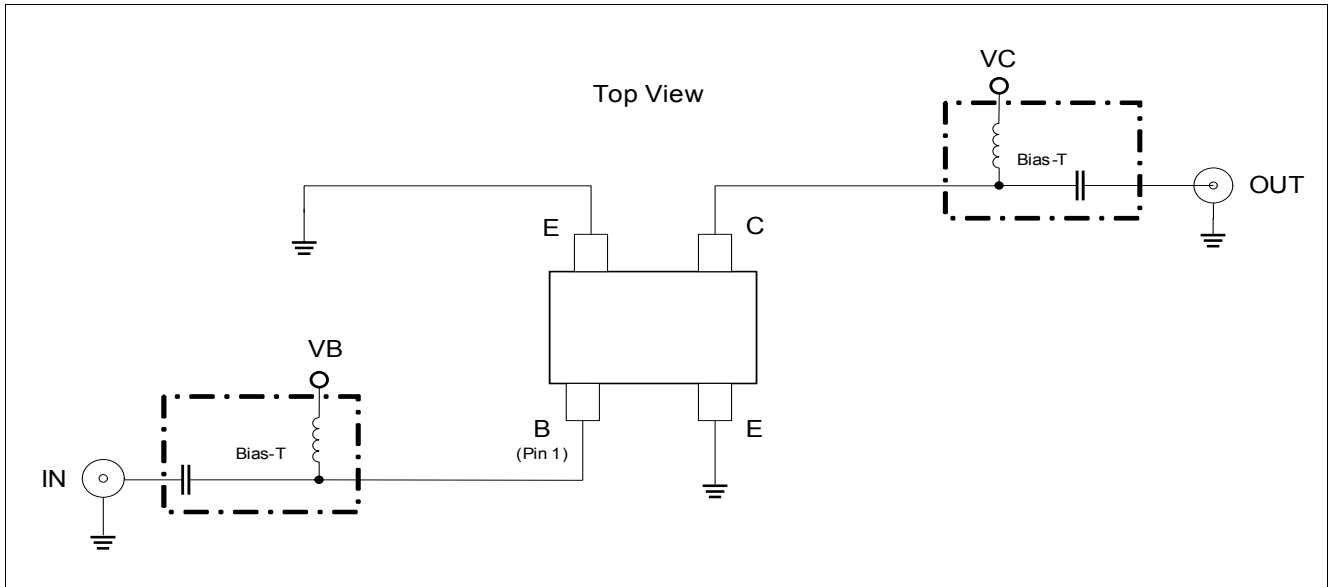

Figure 2 BFP640FESD Testing Circuit

Table 7 AC Characteristics, $V_{CE} = 3\ \text{V}$, $f = 150\ \text{MHz}$

Parameter	Symbol	Values			Unit	Note / Test Condition
		Min.	Typ.	Max.		
Maximum power gain					dB	
Low noise operation point	G_{ms}	–	34	–		$I_C = 6\ \text{mA}$
High linearity operation point	G_{ms}	–	40	–		$I_C = 30\ \text{mA}$
Transducer gain					dB	$Z_S = Z_L = 50\ \Omega$
Low noise operation point	S_{21}	–	25.5	–		$I_C = 6\ \text{mA}$
High linearity operation point	S_{21}	–	35.5	–		$I_C = 30\ \text{mA}$
Minimum noise figure					dB	$Z_S = Z_{opt}$
Minimum noise figure	NF_{min}	–	0.55	–		$I_C = 6\ \text{mA}$
Associated gain	G_{ass}	–	30.5	–		$I_C = 6\ \text{mA}$
Linearity					dBm	$Z_S = Z_L = 50\ \Omega$
1 dB gain compression point	OP_{1dB}	–	11	–		$I_C = 30\ \text{mA}$
3rd order intercept point	OIP_3	–	24.5	–		$I_C = 30\ \text{mA}$

Electrical Characteristics
Table 8 AC Characteristics, $V_{CE} = 3\text{ V}$, $f = 450\text{ MHz}$

Parameter	Symbol	Values			Unit	Note / Test Condition
		Min.	Typ.	Max.		
Maximum power gain						
Low noise operation point	G_{ms}	–	29	–	dB	$I_C = 6\text{ mA}$
High linearity operation point	G_{ms}	–	35	–		$I_C = 30\text{ mA}$
Transducer gain						
Low noise operation point	S_{21}	–	25	–	dB	$Z_S = Z_L = 50\ \Omega$ $I_C = 6\text{ mA}$
High linearity operation point	S_{21}	–	33	–		$I_C = 30\text{ mA}$
Minimum noise figure						
Minimum noise figure	NF_{min}	–	0.55	–	dB	$Z_S = Z_{opt}$ $I_C = 6\text{ mA}$
Associated gain	G_{ass}	–	28.5	–		$I_C = 6\text{ mA}$
Linearity						
1 dB gain compression point	OP_{1dB}	–	11	–	dBm	$Z_S = Z_L = 50\ \Omega$ $I_C = 30\text{ mA}$
3rd order intercept point	OIP_3	–	24.5	–		$I_C = 30\text{ mA}$

Table 9 AC Characteristics, $V_{CE} = 3\text{ V}$, $f = 900\text{ MHz}$

Parameter	Symbol	Values			Unit	Note / Test Condition
		Min.	Typ.	Max.		
Maximum power gain						
Low noise operation point	G_{ms}	–	26	–	dB	$I_C = 6\text{ mA}$
High linearity operation point	G_{ms}	–	31.5	–		$I_C = 30\text{ mA}$
Transducer gain						
Low noise operation point	S_{21}	–	23.5	–	dB	$Z_S = Z_L = 50\ \Omega$ $I_C = 6\text{ mA}$
High linearity operation point	S_{21}	–	29.5	–		$I_C = 30\text{ mA}$
Minimum noise figure						
Minimum noise figure	NF_{min}	–	0.55	–	dB	$Z_S = Z_{opt}$ $I_C = 6\text{ mA}$
Associated gain	G_{ass}	–	26	–		$I_C = 6\text{ mA}$
Linearity						
1 dB gain compression point	OP_{1dB}	–	11	–	dBm	$Z_S = Z_L = 50\ \Omega$ $I_C = 30\text{ mA}$
3rd order intercept point	OIP_3	–	25	–		$I_C = 30\text{ mA}$

Electrical Characteristics
Table 10 AC Characteristics, $V_{CE} = 3\text{ V}$, $f = 1.5\text{ GHz}$

Parameter	Symbol	Values			Unit	Note / Test Condition
		Min.	Typ.	Max.		
Maximum power gain					dB	
Low noise operation point	G_{ms}	–	24	–		$I_C = 6\text{ mA}$
High linearity operation point	G_{ms}	–	28.5	–		$I_C = 30\text{ mA}$
Transducer gain					dB	$Z_S = Z_L = 50\ \Omega$
Low noise operation point	S_{21}	–	21.5	–		$I_C = 6\text{ mA}$
High linearity operation point	S_{21}	–	25.5	–		$I_C = 30\text{ mA}$
Minimum noise figure					dB	$Z_S = Z_{opt}$
Minimum noise figure	NF_{min}	–	0.6	–		$I_C = 6\text{ mA}$
Associated gain	G_{ass}	–	22.5	–		$I_C = 6\text{ mA}$
Linearity					dBm	$Z_S = Z_L = 50\ \Omega$
1 dB gain compression point	OP_{1dB}	–	11.5	–		$I_C = 30\text{ mA}$
3rd order intercept point	OIP_3	–	25.5	–		$I_C = 30\text{ mA}$

Table 11 AC Characteristics, $V_{CE} = 3\text{ V}$, $f = 1.9\text{ GHz}$

Parameter	Symbol	Values			Unit	Note / Test Condition
		Min.	Typ.	Max.		
Maximum power gain					dB	
Low noise operation point	G_{ms}	–	23	–		$I_C = 6\text{ mA}$
High linearity operation point	G_{ms}	–	26.5	–		$I_C = 30\text{ mA}$
Transducer gain					dB	$Z_S = Z_L = 50\ \Omega$
Low noise operation point	S_{21}	–	20.5	–		$I_C = 6\text{ mA}$
High linearity operation point	S_{21}	–	23.5	–		$I_C = 30\text{ mA}$
Minimum noise figure					dB	$Z_S = Z_{opt}$
Minimum noise figure	NF_{min}	–	0.6	–		$I_C = 6\text{ mA}$
Associated gain	G_{ass}	–	21	–		$I_C = 6\text{ mA}$
Linearity					dBm	$Z_S = Z_L = 50\ \Omega$
1 dB gain compression point	OP_{1dB}	–	11.5	–		$I_C = 30\text{ mA}$
3rd order intercept point	OIP_3	–	26	–		$I_C = 30\text{ mA}$

Electrical Characteristics
Table 12 AC Characteristics, $V_{CE} = 3\text{ V}$, $f = 2.4\text{ GHz}$

Parameter	Symbol	Values			Unit	Note / Test Condition
		Min.	Typ.	Max.		
Maximum power gain						
Low noise operation point	G_{ms}	–	21.5	–	dB	$I_C = 6\text{ mA}$
High linearity operation point	G_{ms}	–	25	–		$I_C = 30\text{ mA}$
Transducer gain						
Low noise operation point	S_{21}	–	18.5	–	dB	$Z_S = Z_L = 50\ \Omega$ $I_C = 6\text{ mA}$
High linearity operation point	S_{21}	–	21.5	–		$I_C = 30\text{ mA}$
Minimum noise figure						
Minimum noise figure	NF_{min}	–	0.65	–	dB	$Z_S = Z_{opt}$ $I_C = 6\text{ mA}$
Associated gain	G_{ass}	–	19.5	–		$I_C = 6\text{ mA}$
Linearity						
1 dB gain compression point	OP_{1dB}	–	11.5	–	dBm	$Z_S = Z_L = 50\ \Omega$ $I_C = 30\text{ mA}$
3rd order intercept point	OIP_3	–	26	–		$I_C = 30\text{ mA}$

Table 13 AC Characteristics, $V_{CE} = 3\text{ V}$, $f = 3.5\text{ GHz}$

Parameter	Symbol	Values			Unit	Note / Test Condition
		Min.	Typ.	Max.		
Maximum power gain						
Low noise operation point	G_{ms}	–	20	–	dB	$I_C = 6\text{ mA}$
High linearity operation point	G_{ma}	–	21.5	–		$I_C = 30\text{ mA}$
Transducer gain						
Low noise operation point	S_{21}	–	15.5	–	dB	$Z_S = Z_L = 50\ \Omega$ $I_C = 6\text{ mA}$
High linearity operation point	S_{21}	–	18	–		$I_C = 30\text{ mA}$
Minimum noise figure						
Minimum noise figure	NF_{min}	–	0.75	–	dB	$Z_S = Z_{opt}$ $I_C = 6\text{ mA}$
Associated gain	G_{ass}	–	15.5	–		$I_C = 6\text{ mA}$
Linearity						
1 dB gain compression point	OP_{1dB}	–	11.5	–	dBm	$Z_S = Z_L = 50\ \Omega$ $I_C = 30\text{ mA}$
3rd order intercept point	OIP_3	–	26	–		$I_C = 30\text{ mA}$

Table 14 AC Characteristics, $V_{CE} = 3\text{ V}$, $f = 5.5\text{ GHz}$

Parameter	Symbol	Values			Unit	Note / Test Condition
		Min.	Typ.	Max.		
Maximum power gain					dB	
Low noise operation point	G_{ms}	–	17.5	–		$I_C = 6\text{ mA}$
High linearity operation point	G_{ma}	–	16.5	–		$I_C = 30\text{ mA}$
Transducer gain					dB	$Z_S = Z_L = 50\ \Omega$
Low noise operation point	S_{21}	–	12	–		$I_C = 6\text{ mA}$
High linearity operation point	S_{21}	–	14	–		$I_C = 30\text{ mA}$
Minimum noise figure					dB	$Z_S = Z_{opt}$
Minimum noise figure	NF_{min}	–	0.95	–		$I_C = 6\text{ mA}$
Associated gain	G_{ass}	–	13	–		$I_C = 6\text{ mA}$
Linearity					dBm	$Z_S = Z_L = 50\ \Omega$
1 dB gain compression point	OP_{1dB}	–	11	–		$I_C = 30\text{ mA}$
3rd order intercept point	OIP_3	–	25.5	–		$I_C = 30\text{ mA}$

Table 15 AC Characteristics, $V_{CE} = 3\text{ V}$, $f = 10\text{ GHz}$

Parameter	Symbol	Values			Unit	Note / Test Condition
		Min.	Typ.	Max.		
Maximum power gain					dB	
Low noise operation point	G_{ma}	–	10	–		$I_C = 6\text{ mA}$
High linearity operation point	G_{ma}	–	11	–		$I_C = 30\text{ mA}$
Transducer gain					dB	$Z_S = Z_L = 50\ \Omega$
Low noise operation point	S_{21}	–	6	–		$I_C = 6\text{ mA}$
High linearity operation point	S_{21}	–	8	–		$I_C = 30\text{ mA}$
Minimum noise figure					dB	$Z_S = Z_{opt}$
Minimum noise figure	NF_{min}	–	1.7	–		$I_C = 6\text{ mA}$
Associated gain	G_{ass}	–	8	–		$I_C = 6\text{ mA}$
Linearity					dBm	$Z_S = Z_L = 50\ \Omega$
1 dB gain compression point	OP_{1dB}	–	11	–		$I_C = 30\text{ mA}$
3rd order intercept point	OIP_3	–	24.5	–		$I_C = 30\text{ mA}$

Note:

- $G_{ms} = |S_{21} / S_{12}|$ for $k < 1$; $G_{ma} = |S_{21} / S_{12}|(k - (k^2 - 1)^{1/2})$ for $k > 1$
- In order to get the NF_{min} values stated in this chapter the test fixture losses have been subtracted from all measured result
- OIP_3 value depends on termination of all intermodulation frequency components. Termination used for this measurement is $50\ \Omega$ from 0.2 MHz to 12 GHz.

5.4 Characteristic DC Diagrams

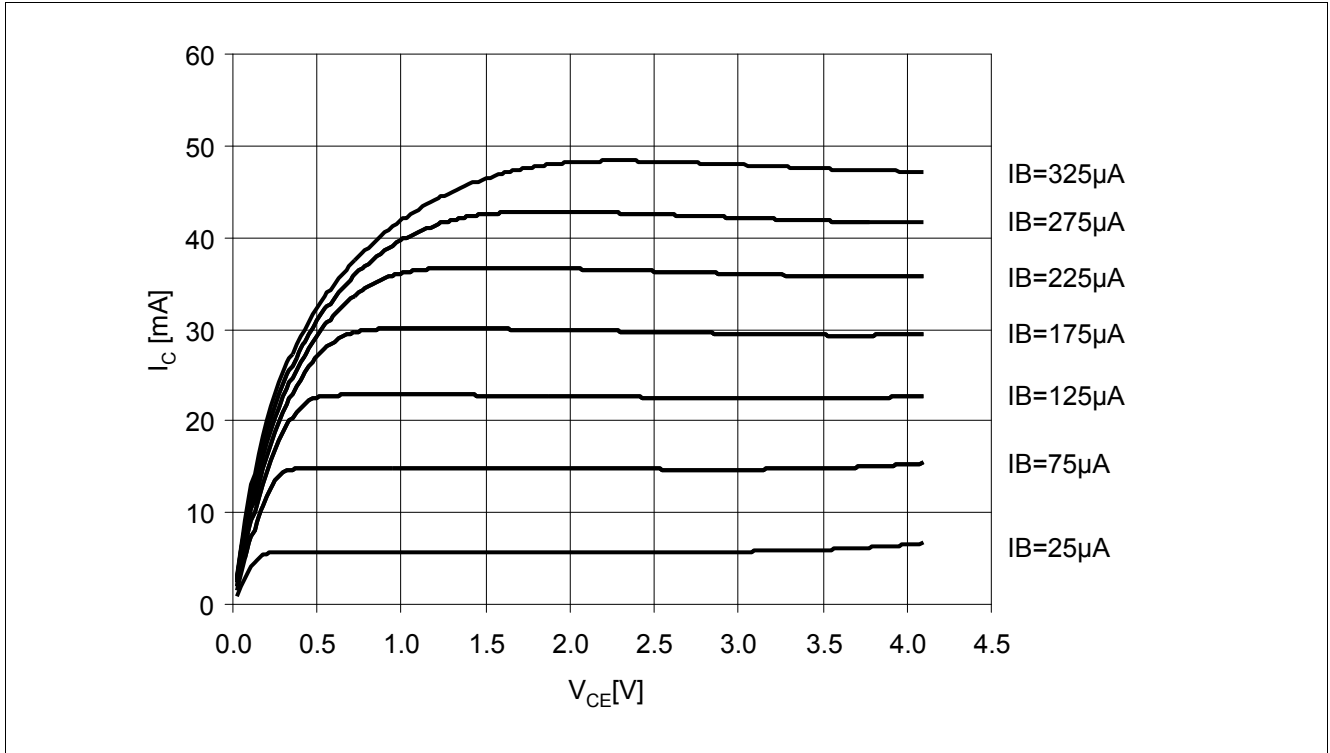

Figure 3 Collector Current vs. Collector Emitter Voltage $I_C = f(V_{CE})$, $I_B = \text{Parameter}$

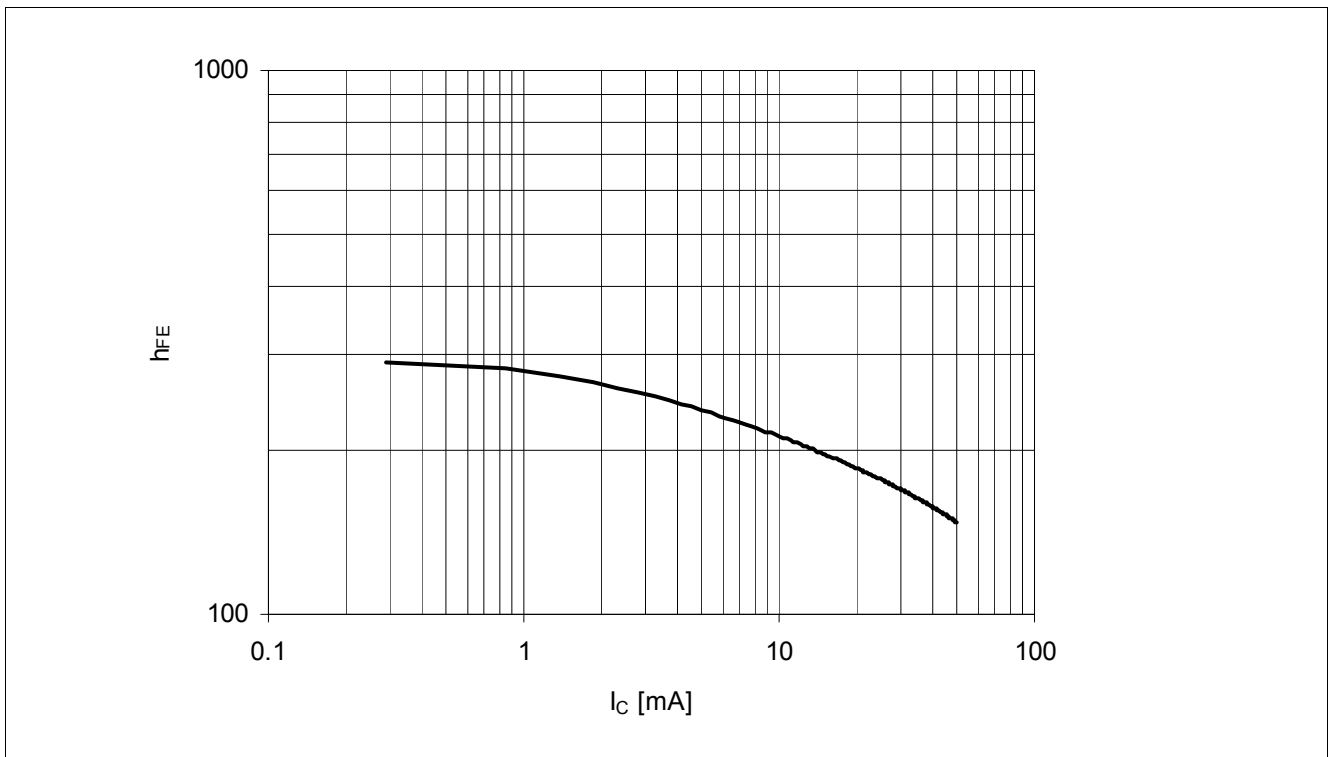

Figure 4 DC Current Gain $h_{FE} = f(I_C)$, $V_{CE} = 3 \text{ V}$

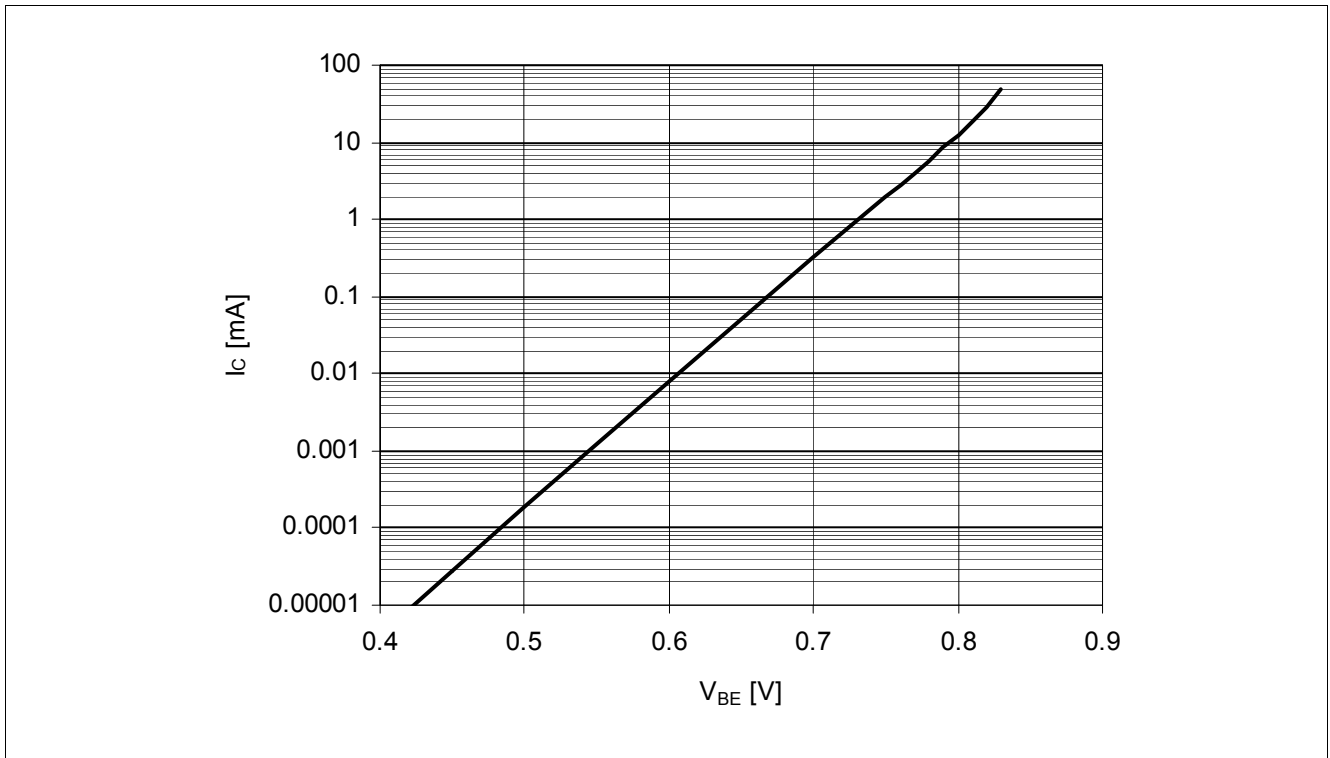

Figure 5 Collector Current vs. Base-Emitter Voltage $I_C = f(V_{BE})$, $V_{CE} = 2\text{ V}$

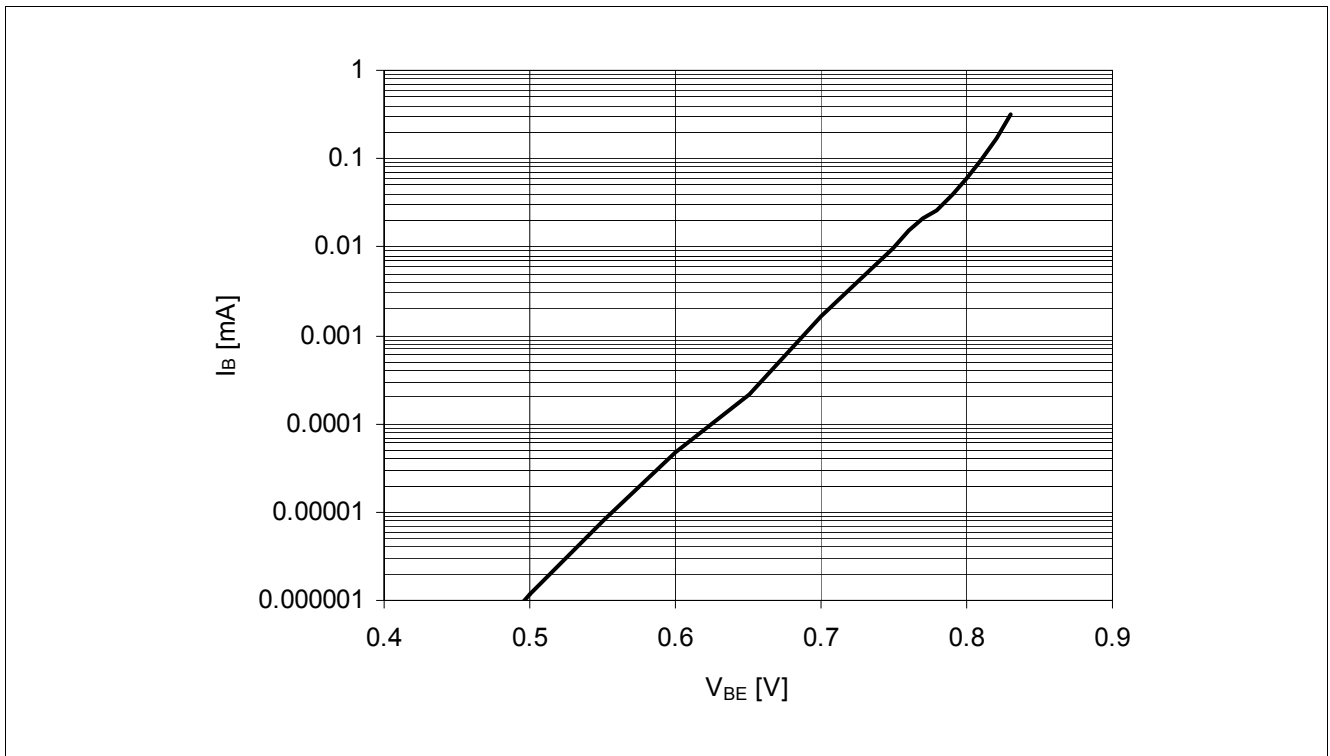

Figure 6 Base Current vs. Base Emitter Forward Voltage $I_B = f(V_{BE})$, $V_{CE} = 2\text{ V}$

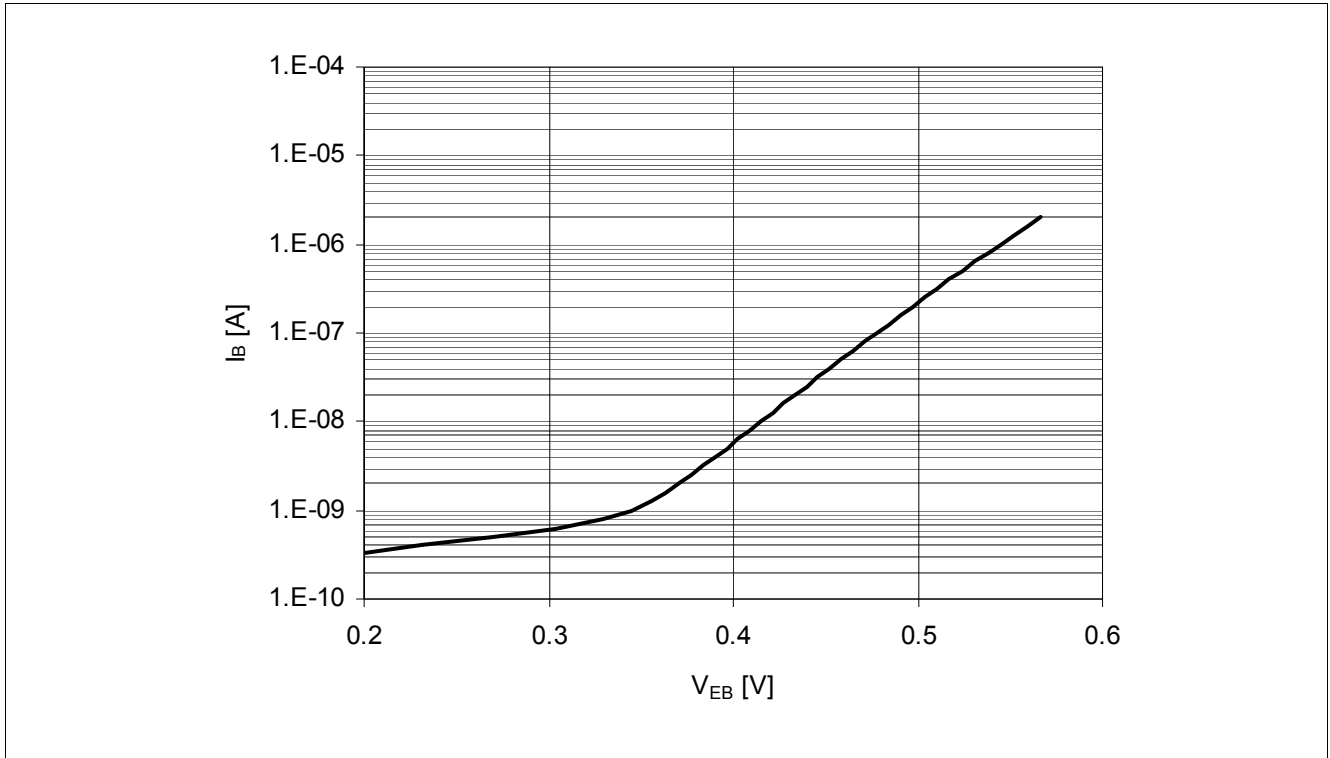

Figure 7 Base Current vs. Base Emitter Reverse Voltage $I_B = f(V_{EB})$, $V_{CE} = 2\text{ V}$

5.5 Characteristic AC Diagrams

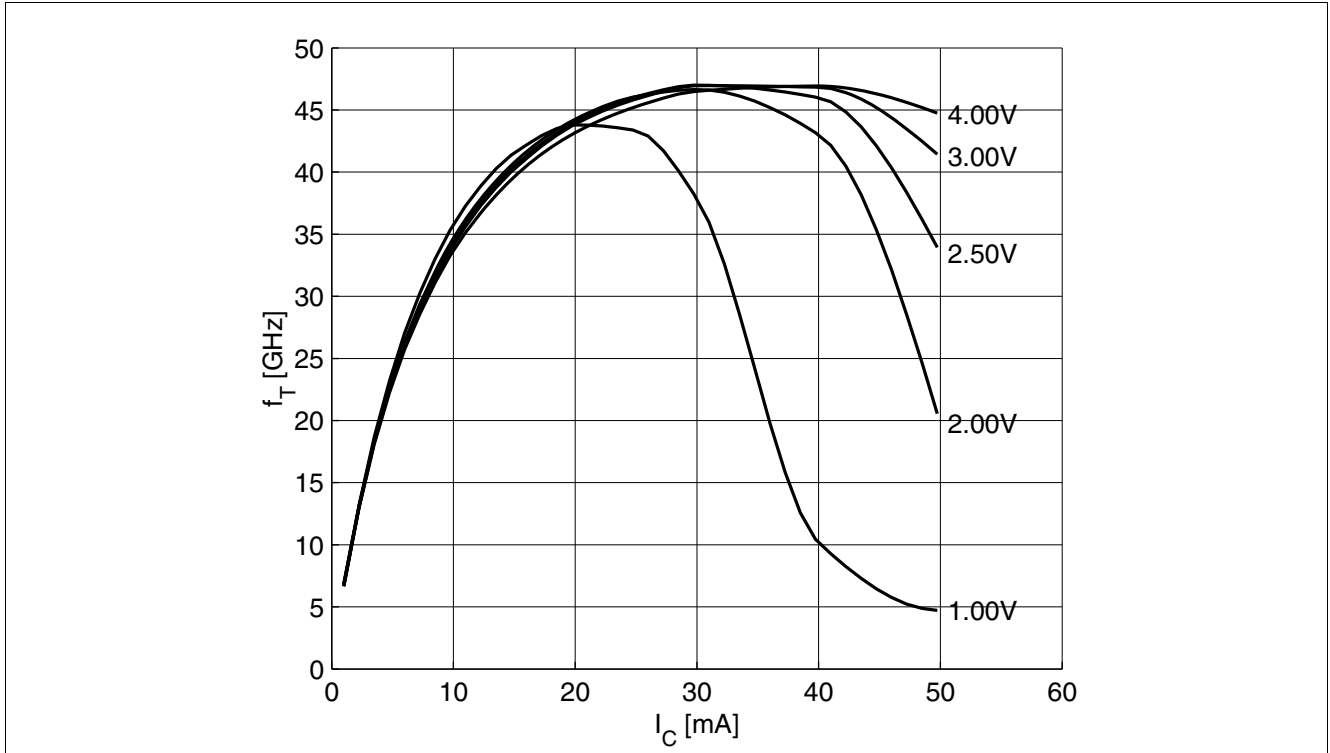

Figure 8 Transition Frequency $f_T = f(I_C)$, $f = 1 \text{ GHz}$, $V_{CE} = \text{Parameter}$

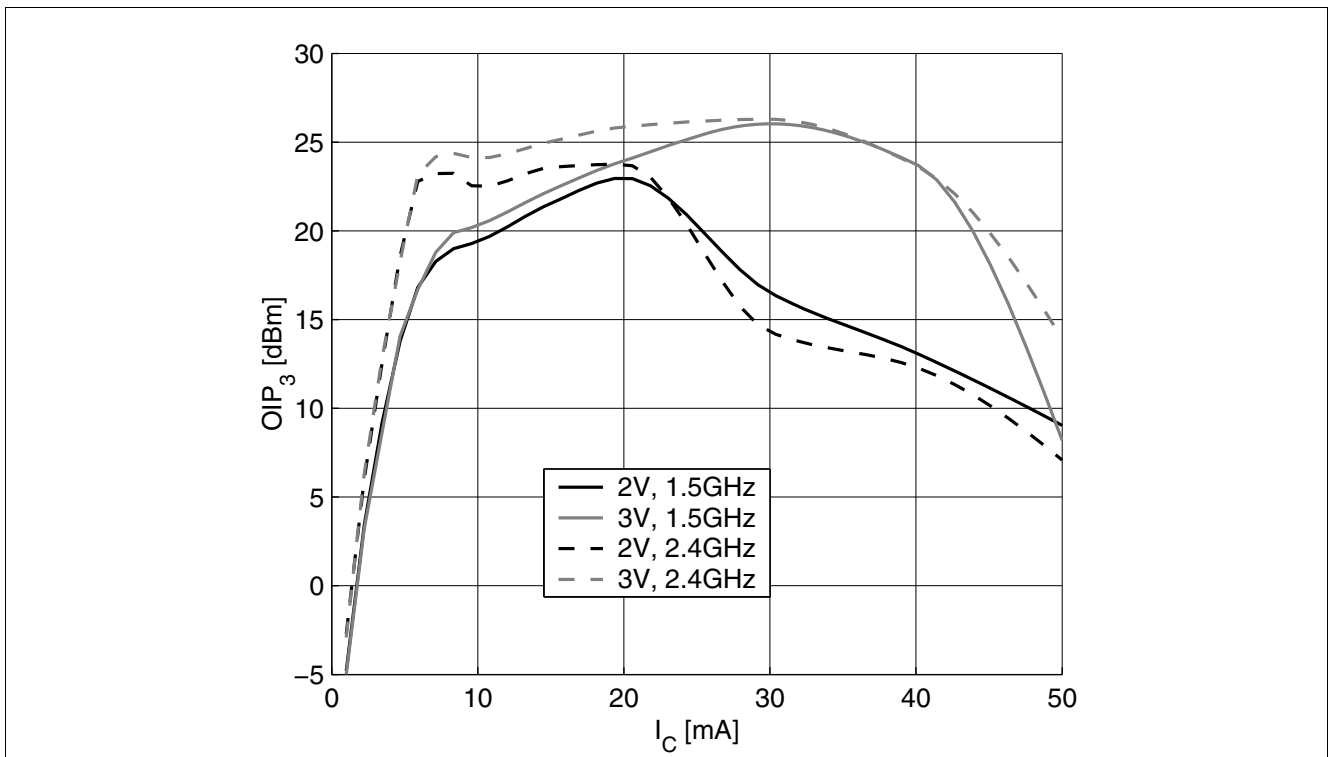

Figure 9 3rd Order Intercept Point $OIP_3 = f(I_C)$, $Z_S = Z_L = 50 \Omega$, $V_{CE}, f = \text{Parameters}$

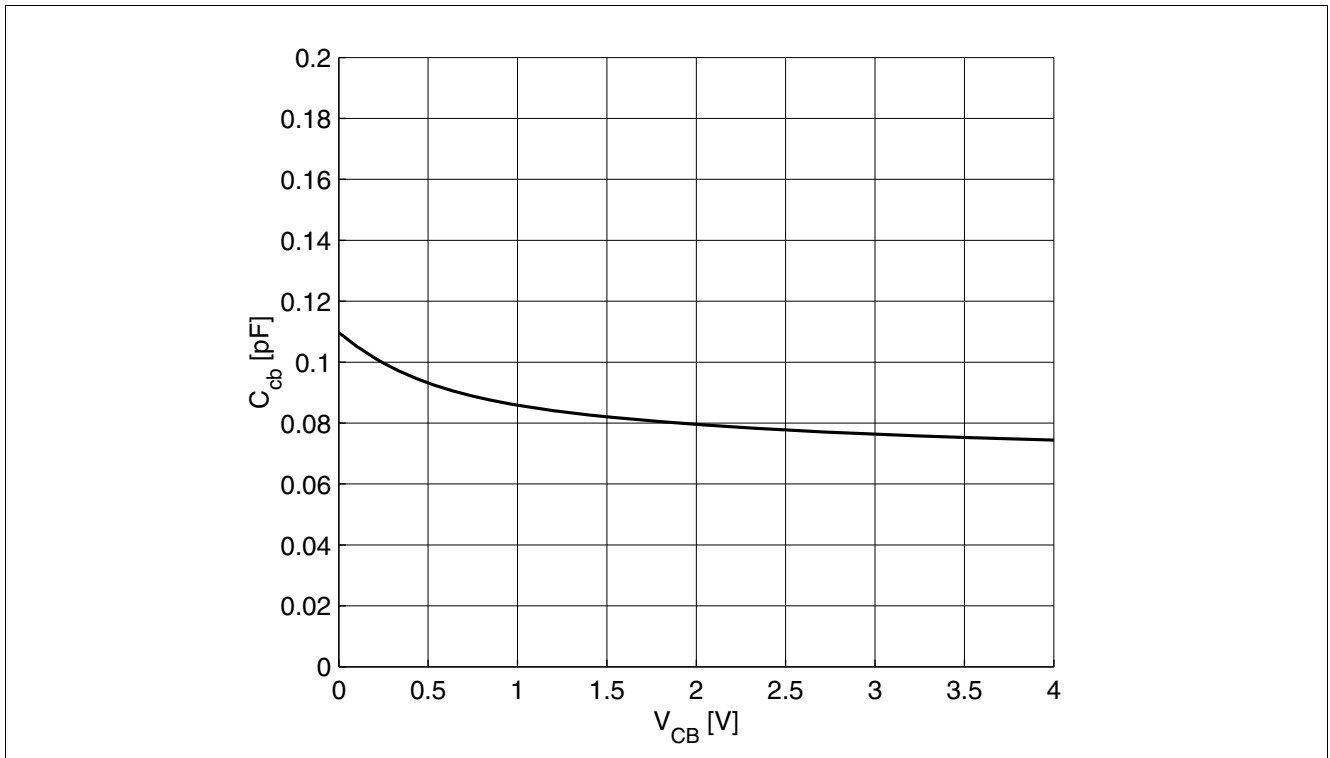

Figure 10 Collector Base Capacitance $C_{CB} = f(V_{CB})$, $f = 1$ MHz

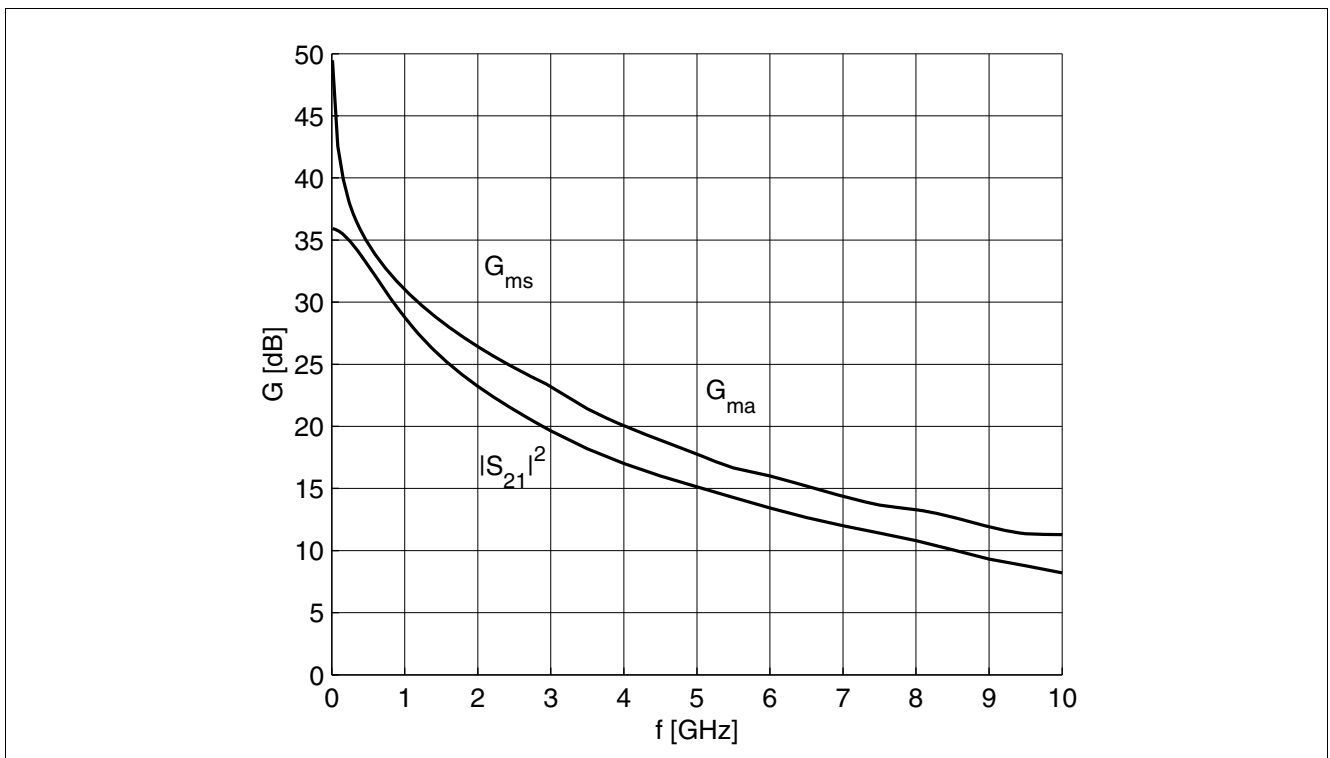

Figure 11 Gain G_{ma} , G_{ms} , $|S_{21}|^2 = f(f)$, $V_{CE} = 3$ V, $I_C = 30$ mA

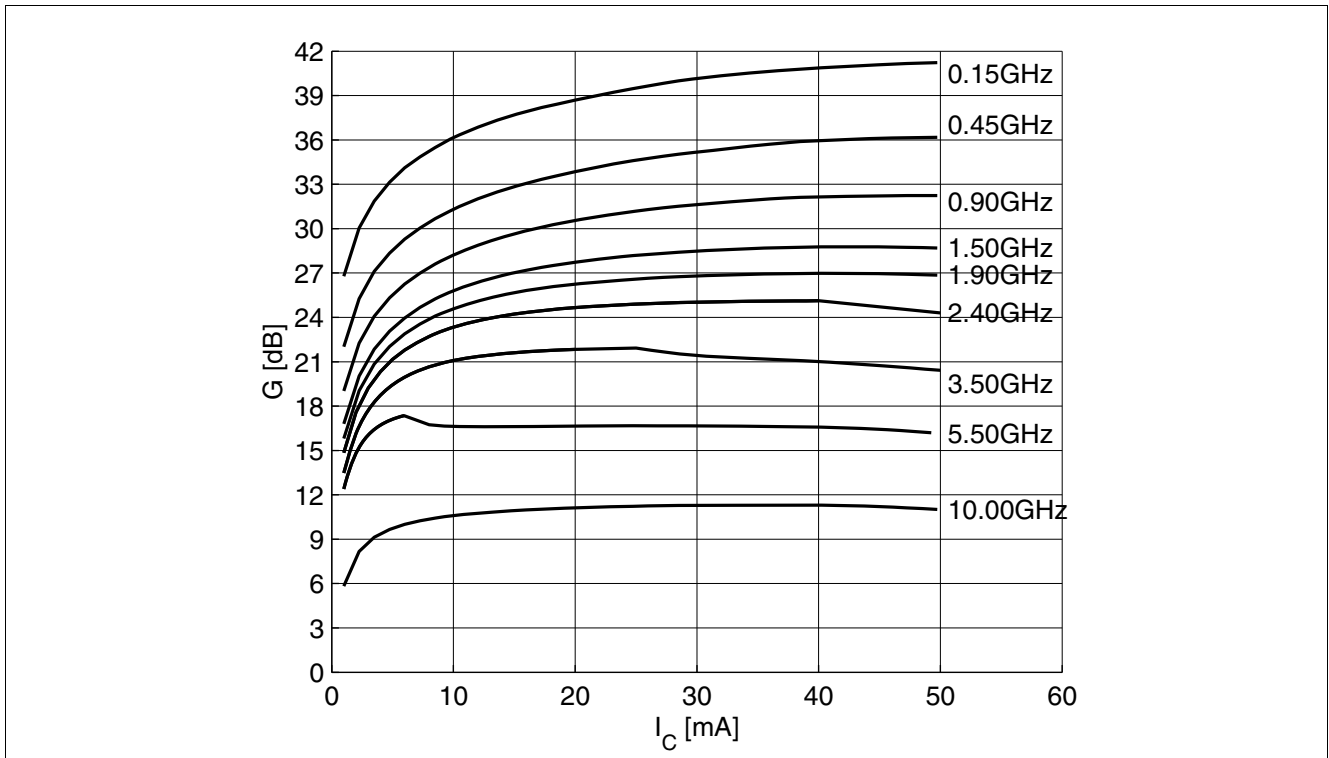

Figure 12 Maximum Power Gain $G_{max} = f(I_C)$, $V_{CE} = 3\text{ V}$, $f = \text{Parameter in GHz}$

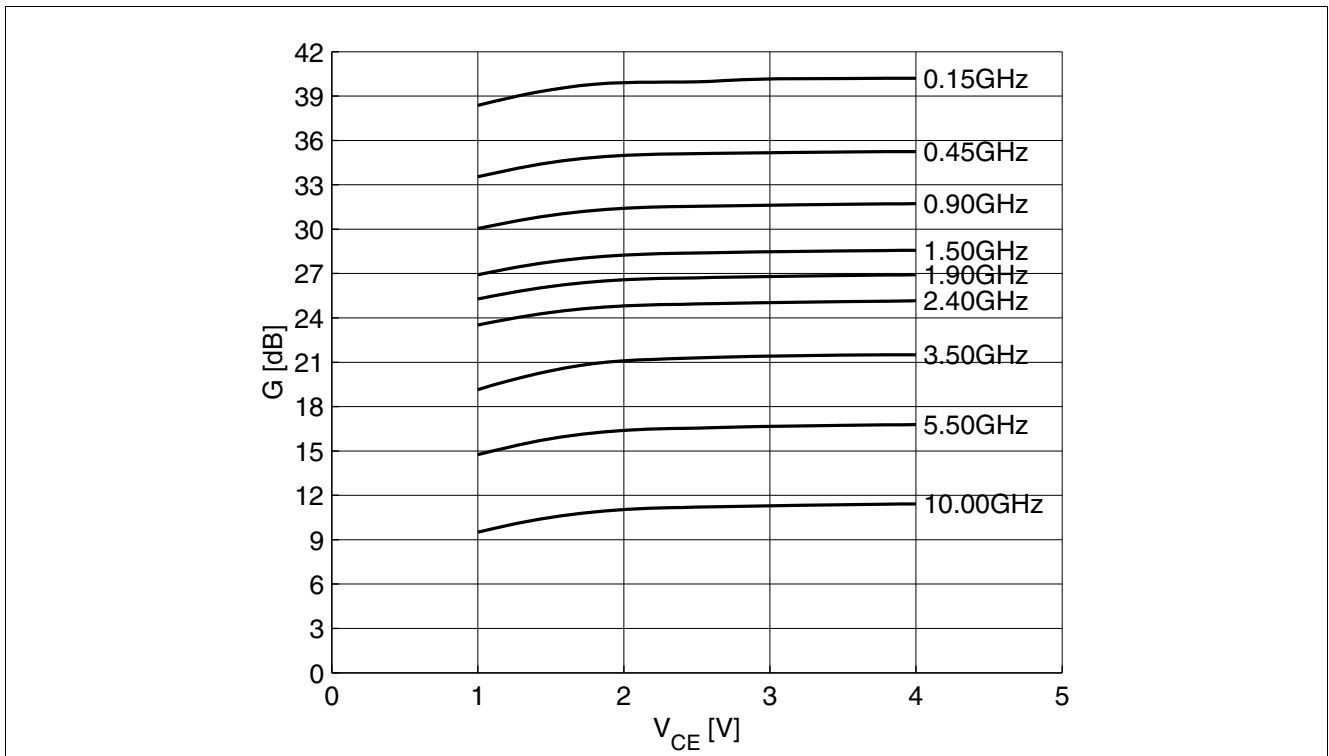

Figure 13 Maximum Power Gain $G_{max} = f(V_{CE})$, $I_C = 30\text{ mA}$, $f = \text{Parameter in GHz}$

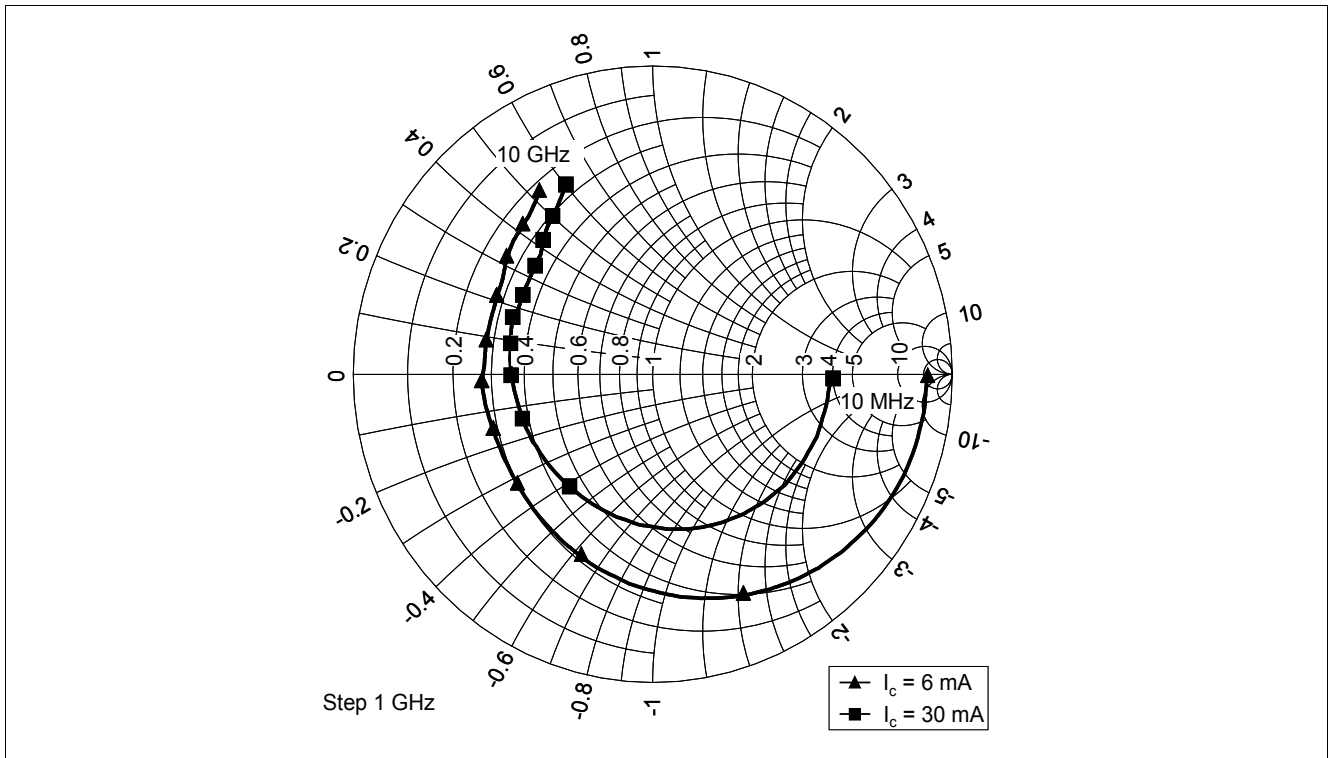

Figure 14 Input Matching $S_{11} = f(f)$, $V_{CE} = 3 \text{ V}$, $I_C = 6 / 30 \text{ mA}$

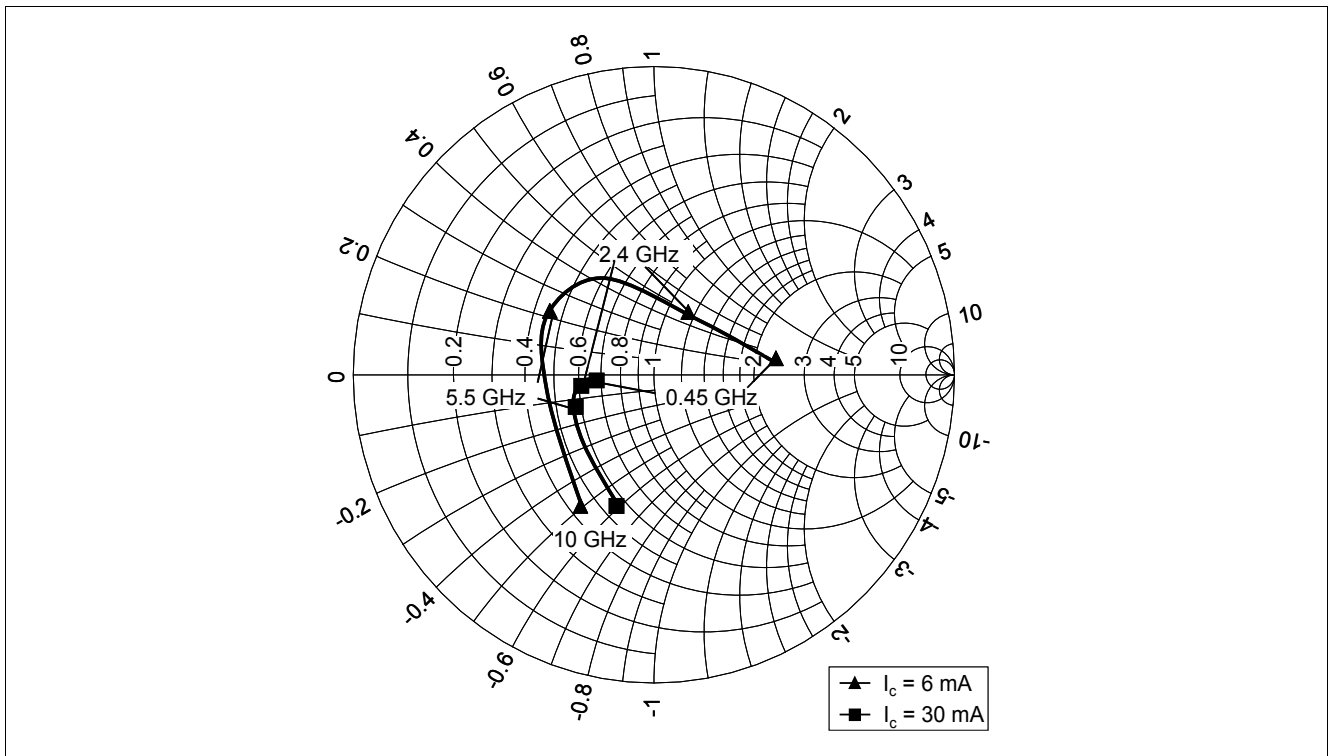

Figure 15 Source Impedance for Minimum Noise Figure $Z_{opt} = f(f)$, $V_{CE} = 3 \text{ V}$, $I_C = 6 / 30 \text{ mA}$

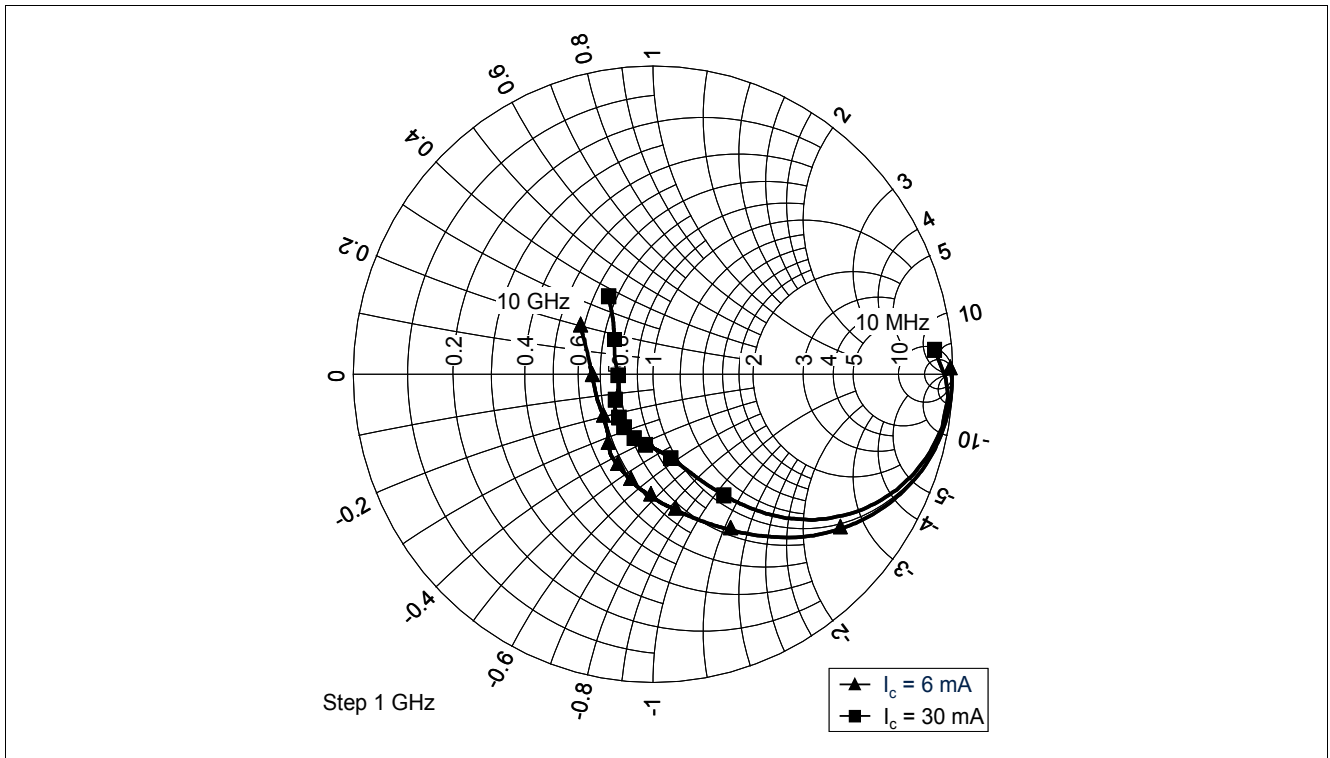

Figure 16 Output Matching $S_{22} = f(f)$, $V_{CE} = 3\text{ V}$, $I_C = 6 / 30\text{ mA}$

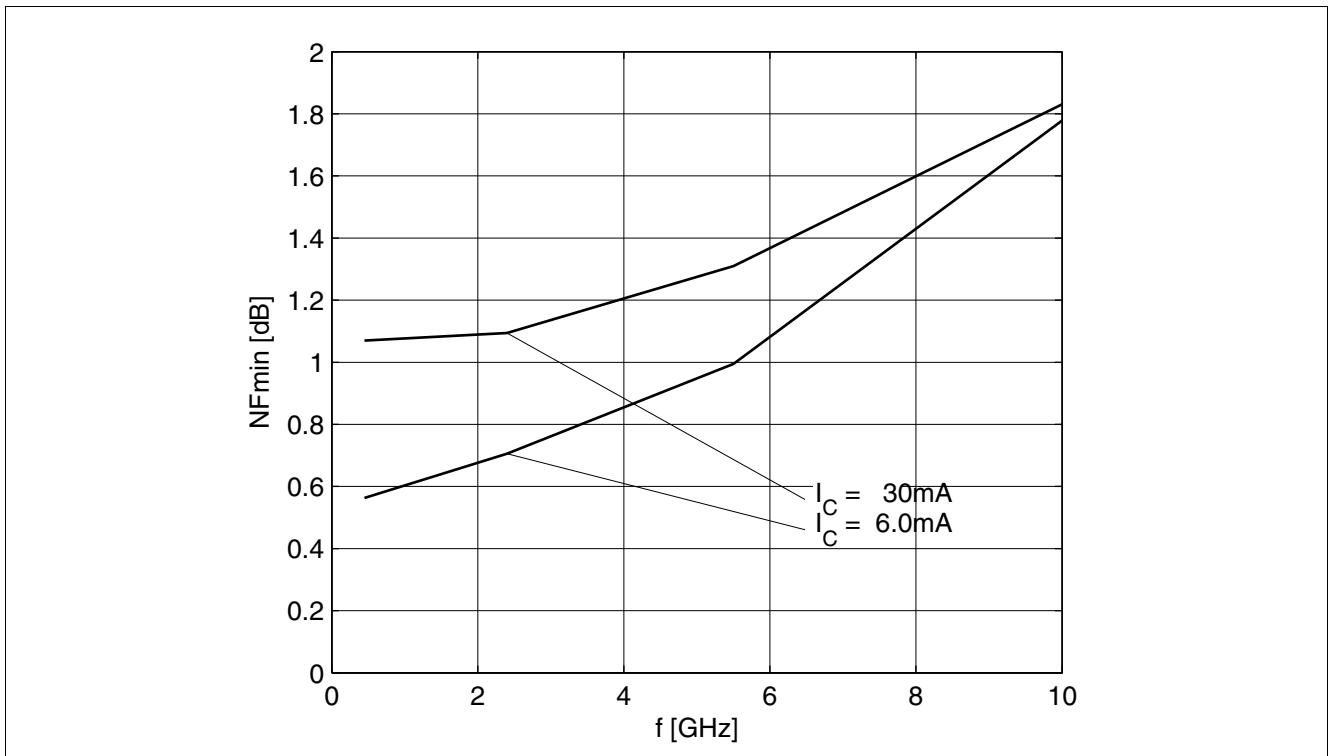

Figure 17 Noise Figure $NF_{min} = f(f)$, $V_{CE} = 3\text{ V}$, $I_C = 6 / 30\text{ mA}$, $Z_S = Z_{opt}$

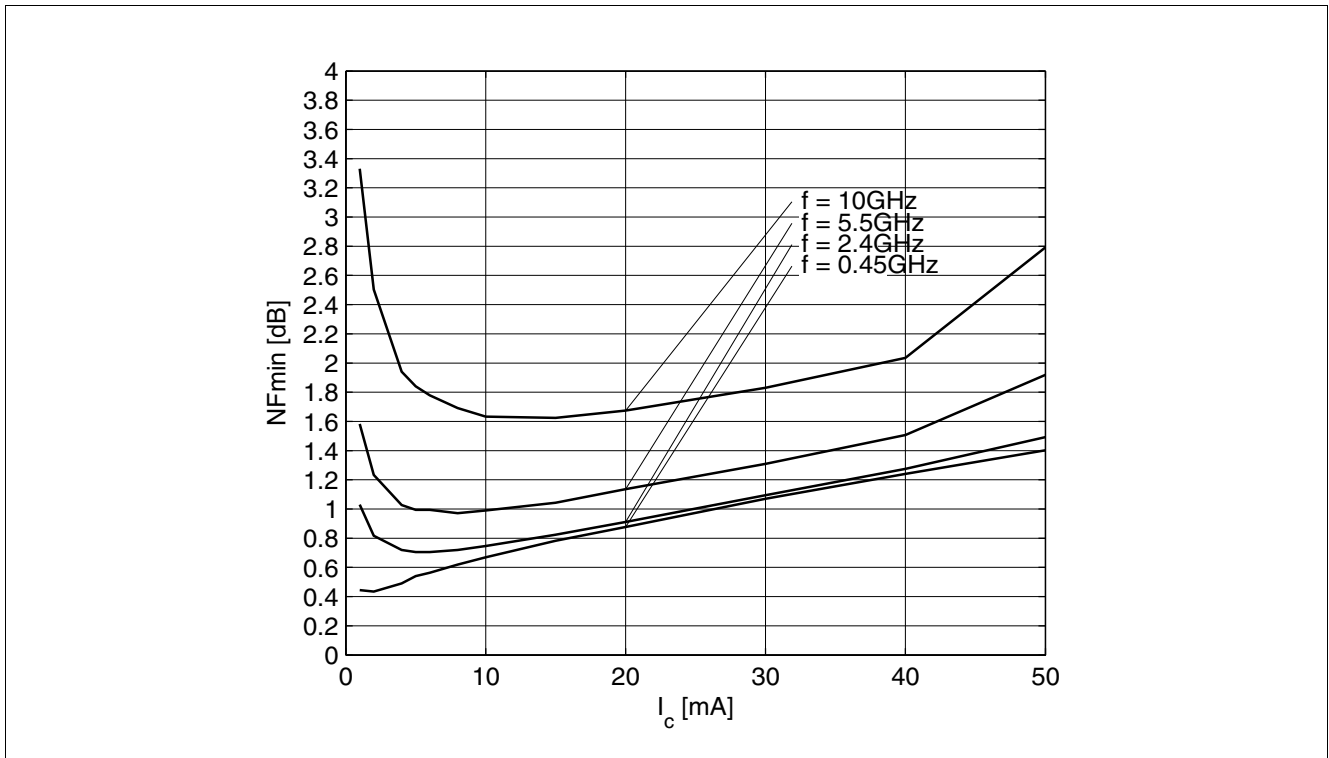

Figure 18 Noise Figure $NF_{min} = f(I_c)$, $V_{CE} = 3\text{ V}$, $Z_S = Z_{opt}$, $f = \text{Parameter in GHz}$

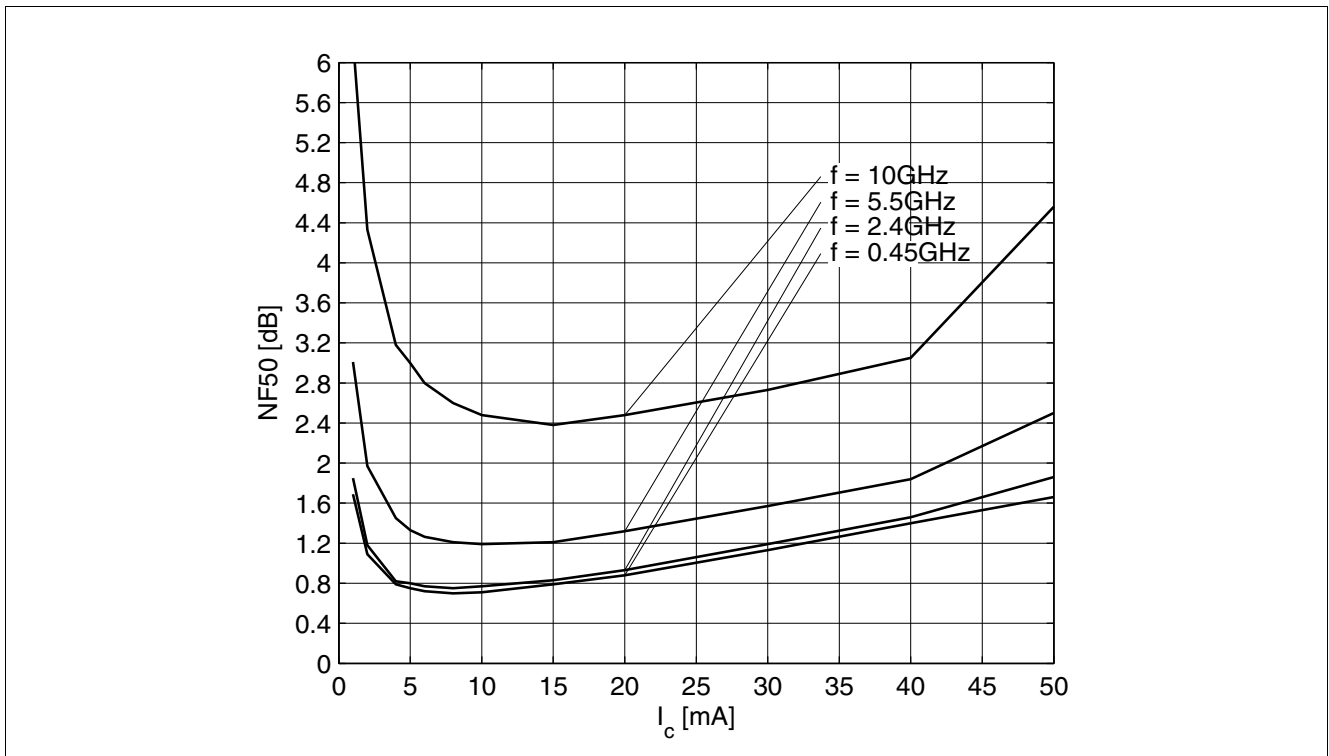

Figure 19 Noise Figure $NF_{50} = f(\text{freq})$, $V_{CE} = 3\text{ V}$, $Z_S = 50\ \Omega$, $f = \text{Parameter in GHz}$

Note: The curves shown in this chapter have been generated using typical devices but shall not be considered as a guarantee that all devices have identical characteristic curves. $T_A = 25^\circ\text{C}$.

6 Simulation Data

For the SPICE Gummel Poon (GP) model as well as for the S-parameters (including noise parameters) please refer to our internet website: www.infineon.com/rf.models. Please consult our website and download the latest versions before actually starting your design.

You find the BFP640FESD SPICE GP model in the internet in MWO- and ADS-format, which you can import into these circuit simulation tools very quickly and conveniently. The model already contains the package parasitics and is ready to use for DC- and high frequency simulations. The terminals of the model circuit correspond to the pin configuration of the device.

The model parameters have been extracted and verified up to 10 GHz using typical devices. The BFP640FESD SPICE GP model reflects the typical DC- and RF-performance within the limitations which are given by the SPICE GP model itself. Besides the DC characteristics all S-parameters in magnitude and phase, as well as noise figure (including optimum source impedance, equivalent noise resistance and flicker noise) and intermodulation have been extracted.

7 Package Information TSFP-4-1

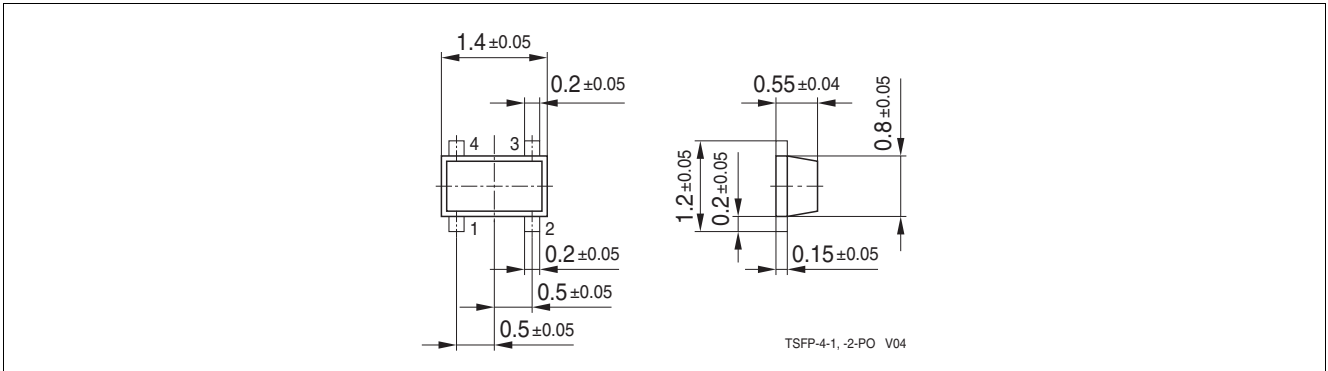

Figure 20 Package Outline

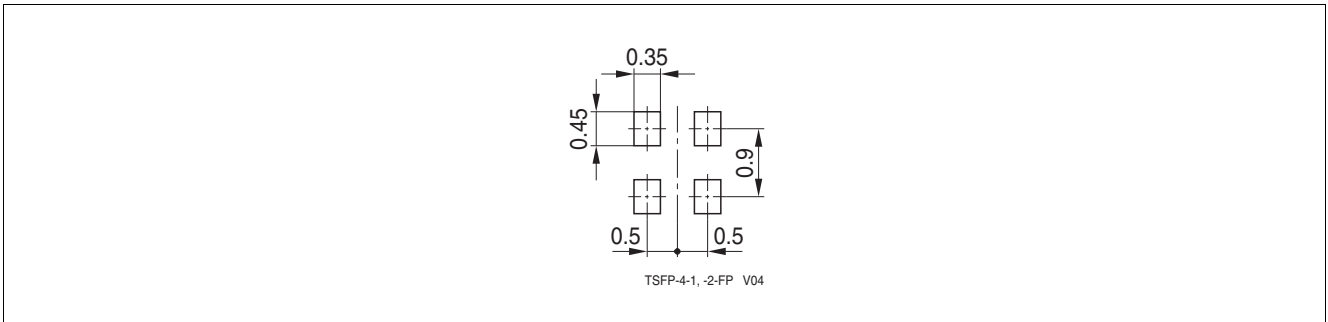

Figure 21 Package Foot Print

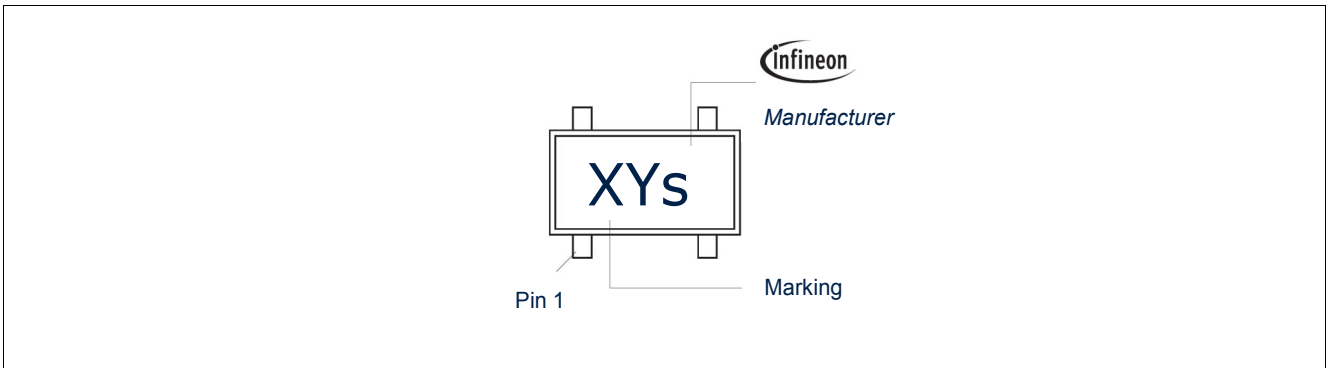

Figure 22 Marking Description (Marking BFP640FESD: T4s)

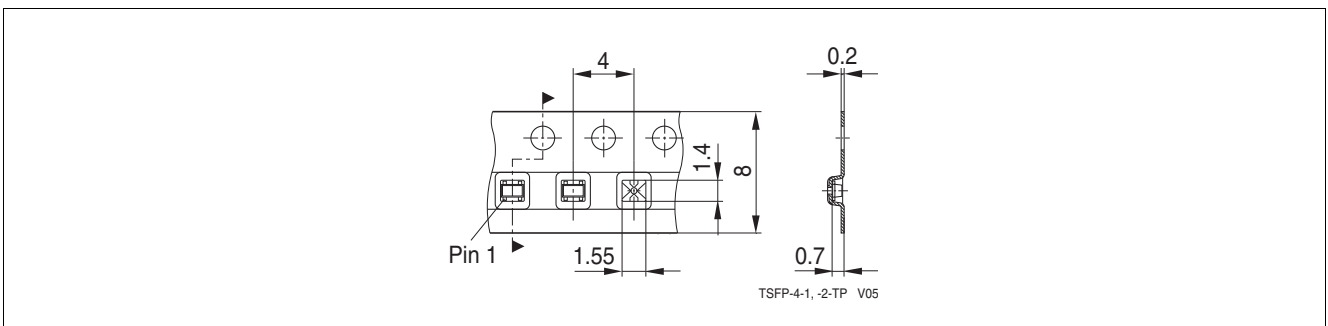

Figure 23 Tape Dimensions

www.infineon.com

Published by Infineon Technologies AG



Стандарт Электрон Связь

Мы молодая и активно развивающаяся компания в области поставок электронных компонентов. Мы поставляем электронные компоненты отечественного и импортного производства напрямую от производителей и с крупнейших складов мира.

Благодаря сотрудничеству с мировыми поставщиками мы осуществляем комплексные и плановые поставки широчайшего спектра электронных компонентов.

Собственная эффективная логистика и склад в обеспечивает надежную поставку продукции в точно указанные сроки по всей России.

Мы осуществляем техническую поддержку нашим клиентам и предпродажную проверку качества продукции. На все поставляемые продукты мы предоставляем гарантию .

Осуществляем поставки продукции под контролем ВП МО РФ на предприятия военно-промышленного комплекса России , а также работаем в рамках 275 ФЗ с открытием отдельных счетов в уполномоченном банке. Система менеджмента качества компании соответствует требованиям ГОСТ ISO 9001.

Минимальные сроки поставки, гибкие цены, неограниченный ассортимент и индивидуальный подход к клиентам являются основой для выстраивания долгосрочного и эффективного сотрудничества с предприятиями радиоэлектронной промышленности, предприятиями ВПК и научно-исследовательскими институтами России.

С нами вы становитесь еще успешнее!

Наши контакты:

Телефон: +7 812 627 14 35

Электронная почта: sales@st-electron.ru

Адрес: 198099, Санкт-Петербург,
Промышленная ул, дом № 19, литера Н,
помещение 100-Н Офис 331