

PART NUMBER	LED COLOR			
	POSITION 1	POSITION 2	POSITION 3	POSITION 4
568-2231-110F	RED NON-DIFFUSED	RED NON-DIFFUSED	RED NON-DIFFUSED	** BLANK **
568-2231-111F	RED NON-DIFFUSED	RED NON-DIFFUSED	RED NON-DIFFUSED	RED NON-DIFFUSED
568-2231-131F	RED NON-DIFFUSED	RED NON-DIFFUSED	YELLOW NON-DIFFUSED	RED NON-DIFFUSED
568-2231-310F	RED NON-DIFFUSED	YELLOW NON-DIFFUSED	RED NON-DIFFUSED	** BLANK **
568-2231-311F	RED NON-DIFFUSED	YELLOW NON-DIFFUSED	RED NON-DIFFUSED	RED NON-DIFFUSED
568-2231-222F	RED NON-DIFFUSED	GREEN NON-DIFFUSED	GREEN NON-DIFFUSED	GREEN NON-DIFFUSED
568-2231-322F	RED NON-DIFFUSED	YELLOW NON-DIFFUSED	GREEN NON-DIFFUSED	GREEN NON-DIFFUSED
568-2232-110F	GREEN NON-DIFFUSED	RED NON-DIFFUSED	RED NON-DIFFUSED	** BLANK **
568-2232-121F	GREEN NON-DIFFUSED	RED NON-DIFFUSED	GREEN NON-DIFFUSED	RED NON-DIFFUSED
568-2232-131F	GREEN NON-DIFFUSED	RED NON-DIFFUSED	YELLOW NON-DIFFUSED	RED NON-DIFFUSED
568-2232-210F	GREEN NON-DIFFUSED	GREEN NON-DIFFUSED	RED NON-DIFFUSED	** BLANK **
568-2232-222F	GREEN NON-DIFFUSED	GREEN NON-DIFFUSED	GREEN NON-DIFFUSED	GREEN NON-DIFFUSED
568-2232-323F	GREEN NON-DIFFUSED	YELLOW NON-DIFFUSED	GREEN NON-DIFFUSED	YELLOW NON-DIFFUSED
568-2233-120F	YELLOW NON-DIFFUSED	RED NON-DIFFUSED	GREEN NON-DIFFUSED	** BLANK **
568-2233-322F	YELLOW NON-DIFFUSED	YELLOW NON-DIFFUSED	GREEN NON-DIFFUSED	GREEN NON-DIFFUSED
568-2233-333F	YELLOW NON-DIFFUSED	YELLOW NON-DIFFUSED	YELLOW NON-DIFFUSED	YELLOW NON-DIFFUSED
568-2234-323F	YELLOW / GREEN	YELLOW NON-DIFFUSED	GREEN NON-DIFFUSED	YELLOW NON-DIFFUSED
568-2239-999F	BLUE NON-DIFFUSED	BLUE NON-DIFFUSED	BLUE NON-DIFFUSED	BLUE NON-DIFFUSED

ABSOLUTE MAXIMUM RATINGS AT 25°C AMBIENT							UNITS	RED	GREEN	YELLOW	Y/G BI-COLOR		BLUE
											YELLOW	GREEN	
POWER DISSIPATION							mW	100	100	60	60	100	140
FORWARD DC CURRENT							mA	30	30	20	20	30	30
LINEAR DERATION FROM 50°C / 25°C FOR BLUE							mA/°C	0.4	0.4	0.25	0.25	0.4	0.32
PEAK FORWARD CURRENT (1/10 DUTY CYCLE, 0.1ms PULSE WIDTH)							mA	120	120	80	80	120	100
OPERATING TEMPERATURE							°C	-55 TO +100					-35 TO +85
STORAGE TEMPERATURE							°C	-55 TO +100					-35 TO +85
LEAD SOLDERING TEMPERATURE, 5 SEC, 1/16" FROM BODY							°C	260					

REV	ECN NO	REVISIONS	DRN	CKD	APP	DATE
A		NEW RELEASE	TWC	TC	N.O.	7-7-05
B		ADDED P/N 568-2239-999F, ADDED ABSOLUTE MAX. RATINGS, CHANGED NOTE 4, REMOVED NOTE 6, NOTE 6 WAS NOTE 7, ADDED NOTE 7, ADDED RoHS COMPLIANT SPECIFICATION NOTE.	KLJ	N.O.	MES	12-17-07
C		UPDATED BLUE LED SPECS	KLJ	NO	MES	2-7-08
D		ADDED P/N 568-2233-322F	AJF	KLJ	NO	8-24-10

OPERATING CHARACTERISTICS AT 25°C AMBIENT						
CHARACTERISTICS	LED COLOR	MIN	TYP	MAX	UNITS	TEST CONDITIONS
LUMINOUS INTENSITY	RED	8.7	29		mcd	I _r = 10 mA
	GREEN	32	50			
	YELLOW	10		50		I _r = 20 mA
	BLUE	110		310		
FORWARD VOLTAGE	RED		2.0	2.8	V	I _r = 20 mA
	GREEN		2.1	2.8		
	YELLOW		2.1	2.8		
	BLUE		3.5	4.0		
REVERSE CURRENT	RED		100		µA	V _r = 5 V
	GREEN		100			
	YELLOW		100			
	BLUE			10		
DOMINANT WAVELENGTH	RED				nm	
	GREEN					
	YELLOW					
	BLUE	460	464	480		
PEAK WAVELENGTH	RED		635		nm	
	GREEN		565			
	YELLOW		585			
	BLUE		470			
VIEWING ANGLE	ALL		45		Degree	
CAPACITANCE	RED		20		pf	V _r = 0, f = 1 MHz
	GREEN		35			
	YELLOW		15			
	BLUE					

LED COLOR = YELLOW / GREEN BI-COLOR						
OPERATING CHARACTERISTICS AT 25°C AMBIENT						
CHARACTERISTICS	COLOR	MIN	TYP	MAX	UNITS	TEST CONDITIONS
LUMINOUS INTENSITY	GREEN	2.5	6.3		mcd	I _r = 10 mA
	YELLOW	2.5	4.3			
FORWARD VOLTAGE	GREEN		2.1	2.8	V	I _r = 20 mA
PEAK WAVELENGTH	GREEN		565		nm	
	YELLOW		585			
DOMINANT WAVELENGTH	GREEN		569		nm	MEASURED ON EXELTRON 2001
	YELLOW	583		589		
VIEWING ANGLE			80		Degree	
CAPACITANCE	GREEN		35		pf	V _r = 0, f = 1 MHz
	YELLOW		15			

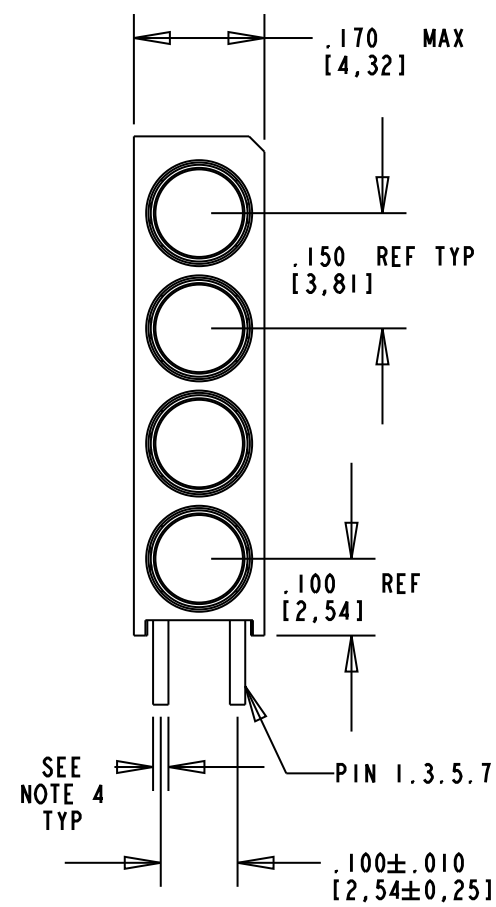

RoHS Compliant 568-223X-XXXX
Thru hole Quad-level CBI

Part Numbers with the "F" suffix ending are RoHS Compliant. For example: 568-2231-111F. The bag packaging is marked with "RoHS Compliant" label or equivalent markings. Parts can be wave soldered, dip soldered or hand soldered using typical lead-free soldering process with max 260°C temp. for 5 sec.

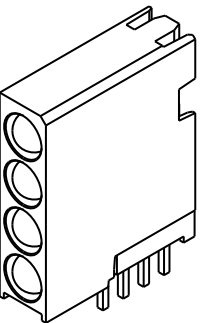
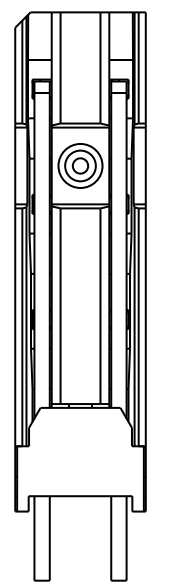
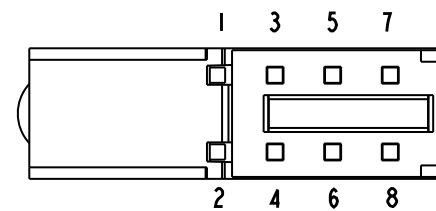
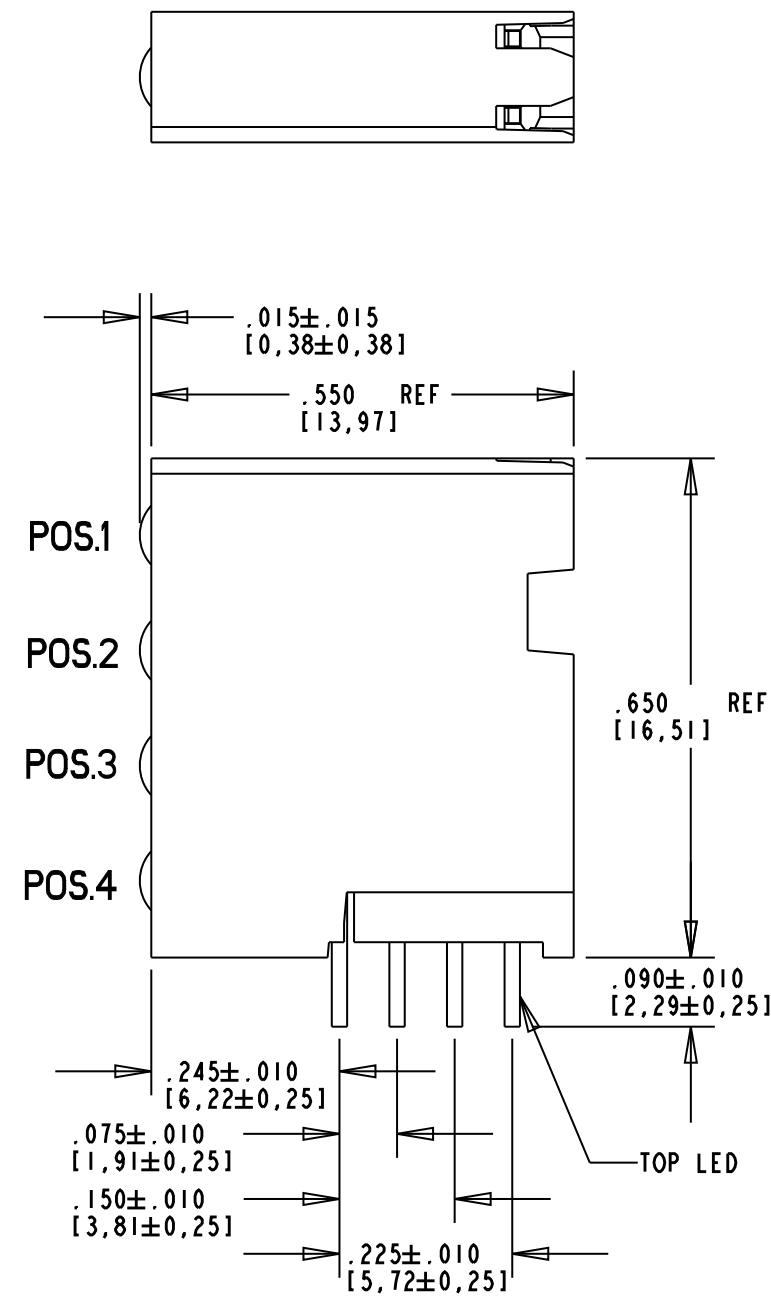

SCALE 2.000

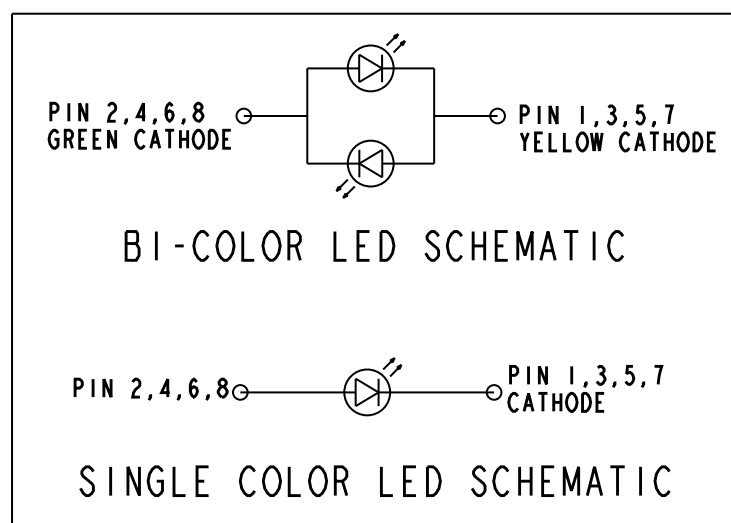
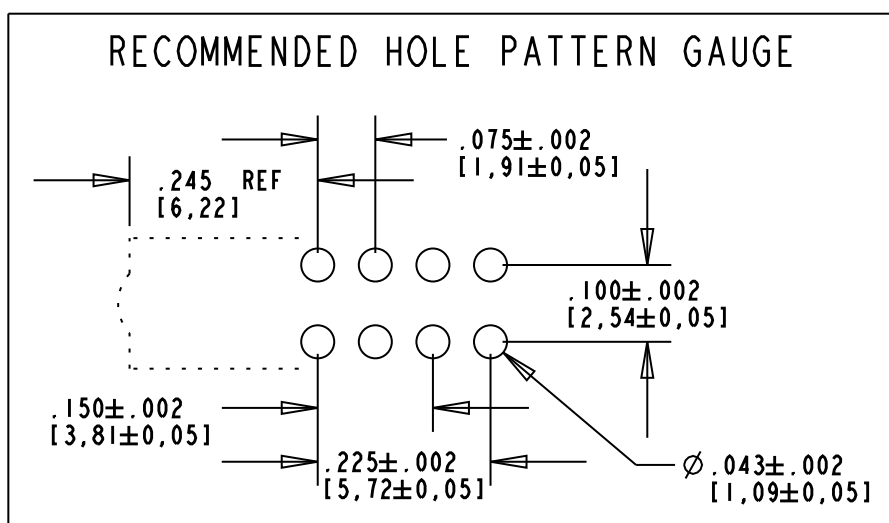

NOTES:

- LEADS TO FIT INTO HOLES SPACED AS PER HOLE PATTERN.
- LEADS TO BE FREE OF DEFORMATION AFTER BENDING AND CUTTING.
- LED LEAD DIMENSIONS SHOWN ARE MEASURED AT HOUSING EXIT
- LED LEAD THICKNESS:
BLUE = .022 MAX/.016 MIN SO.
OTHER = .018 X .016
- WHEN A ZERO APPEARS IN THE LAST 3 DIGITS OF THE PART NUMBER NO LAMP IS REQUIRED IN THAT POSITION.
- DIALIGHT PART NUMBERS: 568-223X-XXXX
- THIS ASSEMBLY CONTAINS ELECTROSTATIC DISCHARGE SENSITIVE DEVICES (ESDS). MAINTAIN ALL PRECAUTIONARY MEASURES DURING ASSEMBLY, HANDLING AND STORAGE IN ACCORDANCE WITH IPC-A-610.



ATTENTION:
OBSERVE PRECAUTIONS FOR
HANDLING ELECTROSTATIC
SENSITIVE DEVICES

THIS DRAWING AND THE CONTENTS HEREIN ARE CONFIDENTIAL AND THE SOLE PROPERTY OF DIALIGHT. REPRODUCTION OF THIS DRAWING OR CONSTRUCTION OF ANY PARTS WITHIN THIS DRAWING ARE FORBIDDEN WITHOUT THE WRITTEN CONSENT OF DIALIGHT.		
SCALE: 4.000	DRAWING NUMBER	REV
ALL DIM'S IN: INCHES (MM)	C-17263	D
TOLERANCES: UNLESS OTHERWISE SPECIFIED	TITLE 4x1 CBI BLOCK - .150 PITCH RoHS COMPLIANT	
FRACTIONS: ±1/64	MATERIAL	
DECIMALS (.XX): ±.01	FINISH:	
DECIMALS (.XXX): ±.005	FSCM 83330	
DECIMALS (.XXXX): ±.0005	SHEET 1 OF 1	
ANGLES: ±1°	FAMILY TABLE:	
	1501 ROUTE 34 SOUTH FARMINGDALE, NJ 07727	



Стандарт Электрон Связь

Мы молодая и активно развивающаяся компания в области поставок электронных компонентов. Мы поставляем электронные компоненты отечественного и импортного производства напрямую от производителей и с крупнейших складов мира.

Благодаря сотрудничеству с мировыми поставщиками мы осуществляем комплексные и плановые поставки широчайшего спектра электронных компонентов.

Собственная эффективная логистика и склад в обеспечивает надежную поставку продукции в точно указанные сроки по всей России.

Мы осуществляем техническую поддержку нашим клиентам и предпродажную проверку качества продукции. На все поставляемые продукты мы предоставляем гарантию .

Осуществляем поставки продукции под контролем ВП МО РФ на предприятия военно-промышленного комплекса России , а также работаем в рамках 275 ФЗ с открытием отдельных счетов в уполномоченном банке. Система менеджмента качества компании соответствует требованиям ГОСТ ISO 9001.

Минимальные сроки поставки, гибкие цены, неограниченный ассортимент и индивидуальный подход к клиентам являются основой для выстраивания долгосрочного и эффективного сотрудничества с предприятиями радиоэлектронной промышленности, предприятиями ВПК и научно-исследовательскими институтами России.

С нами вы становитесь еще успешнее!

Наши контакты:

Телефон: +7 812 627 14 35

Электронная почта: sales@st-electron.ru

Адрес: 198099, Санкт-Петербург,
Промышленная ул, дом № 19, литера Н,
помещение 100-Н Офис 331