

AD8278/AD8279

FEATURES

- Wide input range beyond supplies
- Rugged input overvoltage protection
- Low supply current: 200 μA maximum (per amplifier)
- Low power dissipation: 0.5 mW at $V_S = 2.5\text{ V}$
- Bandwidth: 1 MHz ($G = \frac{1}{2}$)
- CMRR: 80 dB minimum, dc to 20 kHz ($G = \frac{1}{2}$, B Grade)
- Low offset voltage drift: $\pm 1\ \mu\text{V}/^\circ\text{C}$ maximum (B Grade)
- Low gain drift: 1 ppm/ $^\circ\text{C}$ maximum (B Grade)
- Enhanced slew rate: 1.4 V/ μs
- Wide power supply range
 - Single supply: 2 V to 36 V
 - Dual supplies: $\pm 2\text{ V}$ to $\pm 18\text{ V}$
- 8-lead SOIC, 14-lead SOIC, and 8-lead MSOP packages

APPLICATIONS

- Voltage measurement and monitoring
- Current measurement and monitoring
- Instrumentation amplifier building block
- Portable, battery-powered equipment
- Test and measurement

GENERAL DESCRIPTION

The AD8278 and AD8279 are general-purpose difference amplifiers intended for precision signal conditioning in power critical applications that require both high performance and low power. The AD8278 and AD8279 provide exceptional common-mode rejection ratio (80 dB) and high bandwidth while amplifying input signals that are well beyond the supply rails. The on-chip resistors are laser trimmed for excellent gain accuracy and high CMRR. They also have extremely low gain drift vs. temperature.

The common-mode range of the amplifier extends to almost triple the supply voltage (for $G = \frac{1}{2}$), making the amplifier ideal for single-supply applications that require a high common-mode voltage range. The internal resistors and ESD circuitry at the inputs also provide overvoltage protection to the op amp.

The AD8278 and AD8279 can be used as difference amplifiers with $G = \frac{1}{2}$ or $G = 2$. They can also be connected in a high precision, single-ended configuration for non inverting and inverting gains of $-\frac{1}{2}$, -2 , $+3$, $+2$, $+1\frac{1}{2}$, $+1$, or $+\frac{1}{2}$. The AD8278 and AD8279 provide an integrated precision solution that has a smaller size, lower cost, and better performance than a discrete alternative.

The AD8278 and AD8279 operate on single supplies (2.0 V to 36 V) or dual supplies ($\pm 2\text{ V}$ to $\pm 18\text{ V}$). The maximum quiescent supply current is 200 μA , which is ideal for battery-operated and portable systems. For unity-gain difference amplifiers with similar performance, refer to the [AD8276](#) and [AD8277](#) data sheets.

Rev. C

Information furnished by Analog Devices is believed to be accurate and reliable. However, no responsibility is assumed by Analog Devices for its use, nor for any infringements of patents or other rights of third parties that may result from its use. Specifications subject to change without notice. No license is granted by implication or otherwise under any patent or patent rights of Analog Devices. Trademarks and registered trademarks are the property of their respective owners.

FUNCTIONAL BLOCK DIAGRAMS



Figure 1. AD8278

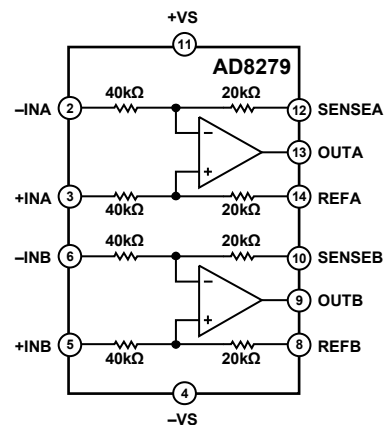

Figure 2. AD8279

Table 1. Difference Amplifiers by Category

| Low Distortion | High Voltage | Current Sensing ¹ | Low Power |
|----------------|--------------|------------------------------|-----------|
| AD8270 | AD628 | AD8202 (U) | AD8276 |
| AD8271 | AD629 | AD8203 (U) | AD8277 |
| AD8273 | | AD8205 (B) | |
| AD8274 | | AD8206 (B) | |
| AMP03 | | AD8216 (B) | |

¹U = unidirectional, B = bidirectional.

The AD8278 is available in the space-saving 8-lead MSOP and SOIC packages, and the AD8279 is offered in a 14-lead SOIC package. Both are specified for performance over the industrial temperature range of -40°C to $+85^\circ\text{C}$ and are fully RoHS compliant.

TABLE OF CONTENTS

| | | | |
|--|---|---|----|
| Features | 1 | Typical Performance Characteristics | 9 |
| Applications..... | 1 | Theory of Operation | 16 |
| General Description | 1 | Circuit Information..... | 16 |
| Functional Block Diagrams..... | 1 | Driving the AD8278 and AD8279 | 16 |
| Revision History | 2 | Input Voltage Range..... | 16 |
| Specifications..... | 3 | Power Supplies..... | 17 |
| Absolute Maximum Ratings..... | 7 | Applications Information | 18 |
| Thermal Resistance | 7 | Configurations..... | 18 |
| Maximum Power Dissipation | 7 | Differential Output | 19 |
| Short-Circuit Current | 7 | Instrumentation Amplifier..... | 19 |
| ESD Caution..... | 7 | Outline Dimensions | 20 |
| Pin Configurations and Function Descriptions | 8 | Ordering Guide | 21 |

REVISION HISTORY

1/11—Rev. B to Rev. C

| | |
|---|---|
| Change to Impedance/Differential Parameter, Table 3 | 4 |
| Change to Impedance/Differential Parameter, Table 5 | 6 |

4/10—Rev. A to Rev. B

| | |
|---|----|
| Changed Supply Current Parameters to AD8278 Supply Current Parameter and AD8279 Supply Current Parameter, Table 5 | 6 |
| Updated Outline Dimensions | 20 |

10/09—Rev. 0 to Rev. A

| | |
|---|-----------|
| Added AD8279 and 14-Lead SOIC Model | Universal |
| Changes to Features..... | 1 |
| Changes to General Description | 1 |
| Change to Table 2 | 3 |

| | |
|---|----|
| Change to Table 3 | 4 |
| Change to Table 4 | 5 |
| Change to Table 5 | 6 |
| Added Figure 6 and Table 9 | 8 |
| Changes to Figure 31 and Figure 32..... | 13 |
| Changes to Figure 40, Figure 41, and Figure 42..... | 14 |
| Added Figure 47; Renumbered Sequentially | 15 |
| Changes to Figure 51 to Figure 57..... | 18 |
| Added Differential Output Section | 19 |
| Changes to Figure 59..... | 19 |
| Updated Outline Dimensions..... | 21 |
| Changes to Ordering Guide | 21 |

7/09—Revision 0: Initial Version

SPECIFICATIONS

$V_S = \pm 5\text{ V}$ to $\pm 15\text{ V}$, $V_{REF} = 0\text{ V}$, $T_A = 25^\circ\text{C}$, $R_L = 10\text{ k}\Omega$ connected to ground, $G = \frac{1}{2}$ difference amplifier configuration, unless otherwise noted.

Table 2.

| Parameter | Conditions | G = 1/2 | | | | | | Unit |
|--------------------------------------|--|-----------------|----------|-----------------|-----------------|----------|-----------------|------------------------------|
| | | Grade B | | | Grade A | | | |
| | | Min | Typ | Max | Min | Typ | Max | |
| INPUT CHARACTERISTICS | | | | | | | | |
| System Offset ¹ | | | 50 | 100 | | 50 | 250 | μV |
| Over Temperature | $T_A = -40^\circ\text{C}$ to $+85^\circ\text{C}$ | | | 100 | | | 250 | μV |
| vs. Power Supply | $V_S = \pm 5\text{ V}$ to $\pm 18\text{ V}$ | | | 2.5 | | | 5 | $\mu\text{V/V}$ |
| Average Temperature Coefficient | $T_A = -40^\circ\text{C}$ to $+85^\circ\text{C}$ | | 0.3 | 1 | | 2 | 5 | $\mu\text{V}/^\circ\text{C}$ |
| Common-Mode Rejection Ratio (RTI) | $V_S = \pm 15\text{ V}$, $V_{CM} = \pm 27\text{ V}$, $R_S = 0\ \Omega$ | 80 | | | 74 | | | dB |
| Input Voltage Range ² | | $-3(V_S + 0.1)$ | | $+3(V_S - 1.5)$ | $-3(V_S + 0.1)$ | | $+3(V_S - 1.5)$ | V |
| Impedance ³ | | | | | | | | |
| Differential | | | 120 | | | 120 | | k Ω |
| Common Mode | | | 30 | | | 30 | | k Ω |
| DYNAMIC PERFORMANCE | | | | | | | | |
| Bandwidth | | | 1 | | | 1 | | MHz |
| Slew Rate | | 1.1 | 1.4 | | 1.1 | 1.4 | | V/ μs |
| Channel Separation | $f = 1\text{ kHz}$ | | 130 | | | 130 | | dB |
| Settling Time to 0.01% | 10 V step on output, $C_L = 100\text{ pF}$ | | | 9 | | | 9 | μs |
| Settling Time to 0.001% | | | | 10 | | | 10 | μs |
| GAIN | | | | | | | | |
| Gain Error | | | 0.005 | 0.02 | | 0.01 | 0.05 | % |
| Gain Drift | $T_A = -40^\circ\text{C}$ to $+85^\circ\text{C}$ | | | 1 | | | 5 | ppm/ $^\circ\text{C}$ |
| Gain Nonlinearity | $V_{OUT} = 20\text{ V p-p}$ | | | 7 | | | 12 | ppm |
| OUTPUT CHARACTERISTICS | | | | | | | | |
| Output Voltage Swing ⁴ | $V_S = \pm 15\text{ V}$, $R_L = 10\text{ k}\Omega$, $T_A = -40^\circ\text{C}$ to $+85^\circ\text{C}$ | $-V_S + 0.2$ | | $+V_S - 0.2$ | $-V_S + 0.2$ | | $+V_S - 0.2$ | V |
| Short-Circuit Current Limit | | | ± 15 | | | ± 15 | | mA |
| Capacitive Load Drive | | | 200 | | | 200 | | pF |
| NOISE⁵ | | | | | | | | |
| Output Voltage Noise | $f = 0.1\text{ Hz}$ to 10 Hz | | 1.4 | | | 1.4 | | $\mu\text{V p-p}$ |
| | $f = 1\text{ kHz}$ | | 47 | 50 | | 47 | 50 | nV/ $\sqrt{\text{Hz}}$ |
| POWER SUPPLY⁶ | | | | | | | | |
| AD8278 Supply Current | | | | 200 | | | 200 | μA |
| Over Temperature | $T_A = -40^\circ\text{C}$ to $+85^\circ\text{C}$ | | | 250 | | | 250 | μA |
| AD8279 Supply Current | | | 300 | 350 | | 300 | 350 | μA |
| Over Temperature | $T_A = -40^\circ\text{C}$ to $+85^\circ\text{C}$ | | | 400 | | | 400 | μA |
| Operating Voltage Range ⁷ | | ± 2 | | ± 18 | ± 2 | | ± 18 | V |
| TEMPERATURE RANGE | | | | | | | | |
| Operating Range | | -40 | | $+125$ | -40 | | $+125$ | $^\circ\text{C}$ |

¹ Includes input bias and offset current errors, RTO (referred to output).

² The input voltage range may also be limited by absolute maximum input voltage or by the output swing. See the Input Voltage Range for details.

³ Internal resistors are trimmed to be ratio matched and have $\pm 20\%$ absolute accuracy.

⁴ Output voltage swing varies with supply voltage and temperature. See Figure 22 through Figure 25 for details.

⁵ Includes amplifier voltage and current noise, as well as noise from internal resistors.

⁶ Supply current varies with supply voltage and temperature. See Figure 26 and Figure 28 for details.

⁷ Unbalanced dual supplies can be used, such as $-V_S = -0.5\text{ V}$ and $+V_S = +2\text{ V}$. The positive supply rail must be at least 2 V above the negative supply and reference voltage.

AD8278/AD8279

$V_S = \pm 5\text{ V}$ to $\pm 15\text{ V}$, $V_{REF} = 0\text{ V}$, $T_A = 25^\circ\text{C}$, $R_L = 10\text{ k}\Omega$ connected to ground, $G = 2$ difference amplifier configuration, unless otherwise noted.

Table 3.

| Parameter | Conditions | G = 2 | | | | | | Unit |
|--------------------------------------|---|-------------------|----------|-------------------|-------------------|----------|-------------------|---|
| | | Grade B | | | Grade A | | | |
| | | Min | Typ | Max | Min | Typ | Max | |
| INPUT CHARACTERISTICS | | | | | | | | |
| System Offset ¹ | | | 100 | 200 | | 100 | 500 | μV |
| Over Temperature vs. Power Supply | $T_A = -40^\circ\text{C}$ to $+85^\circ\text{C}$ $V_S = \pm 5\text{ V}$ to $\pm 18\text{ V}$ | | | 200 | | | 500 | μV |
| Average Temperature Coefficient | $T_A = -40^\circ\text{C}$ to $+85^\circ\text{C}$ | | 0.6 | 2 | | 2 | 5 | $\mu\text{V}/^\circ\text{C}$ |
| Common-Mode Rejection Ratio (RTI) | $V_S = \pm 15\text{ V}$, $V_{CM} = \pm 27\text{ V}$, $R_S = 0\ \Omega$ | 86 | | | 80 | | | dB |
| Input Voltage Range ² | | $-1.5(V_S + 0.1)$ | | $+1.5(V_S - 1.5)$ | $-1.5(V_S + 0.1)$ | | $+1.5(V_S - 1.5)$ | V |
| Impedance ³ | | | | | | | | |
| Differential | | | 30 | | | 30 | | k Ω |
| Common Mode | | | 30 | | | 30 | | k Ω |
| DYNAMIC PERFORMANCE | | | | | | | | |
| Bandwidth | | | 550 | | | 550 | | kHz |
| Slew Rate | | 1.1 | 1.4 | | 1.1 | 1.4 | | V/ μs |
| Channel Separation | $f = 1\text{ kHz}$ | | 130 | | | 130 | | dB |
| Settling Time to 0.01% | 10 V step on output, $C_L = 100\text{ pF}$ | | | 10 | | | 10 | μs |
| Settling Time to 0.001% | | | | 11 | | | 11 | μs |
| GAIN | | | | | | | | |
| Gain Error | | | 0.005 | 0.02 | | 0.01 | 0.05 | % |
| Gain Drift | $T_A = -40^\circ\text{C}$ to $+85^\circ\text{C}$ | | | 1 | | | 5 | ppm/ $^\circ\text{C}$ |
| Gain Nonlinearity | $V_{OUT} = 20\text{ V p-p}$ | | | 7 | | | 12 | ppm |
| OUTPUT CHARACTERISTICS | | | | | | | | |
| Output Voltage Swing ⁴ | $V_S = \pm 15\text{ V}$, $R_L = 10\text{ k}\Omega$, $T_A = -40^\circ\text{C}$ to $+85^\circ\text{C}$ | $-V_S + 0.2$ | | $+V_S - 0.2$ | $-V_S + 0.2$ | | $+V_S - 0.2$ | V |
| Short-Circuit Current Limit | | | ± 15 | | | ± 15 | | mA |
| Capacitive Load Drive | | | 350 | | | 350 | | pF |
| NOISE⁵ | | | | | | | | |
| Output Voltage Noise | $f = 0.1\text{ Hz}$ to 10 Hz $f = 1\text{ kHz}$ | | 2.8 | 95 | | 2.8 | 95 | $\mu\text{V p-p}$ nV/ $\sqrt{\text{Hz}}$ |
| POWER SUPPLY⁶ | | | | | | | | |
| AD8278 Supply Current | | | | 200 | | | 200 | μA |
| Over Temperature | $T_A = -40^\circ\text{C}$ to $+85^\circ\text{C}$ | | | 250 | | | 250 | μA |
| AD8279 Supply Current | | | 300 | 350 | | 300 | 350 | μA |
| Over Temperature | $T_A = -40^\circ\text{C}$ to $+85^\circ\text{C}$ | | | 400 | | | 400 | μA |
| Operating Voltage Range ⁷ | | ± 2 | | ± 18 | ± 2 | | ± 18 | V |
| TEMPERATURE RANGE | | | | | | | | |
| Operating Range | | -40 | | $+125$ | -40 | | $+125$ | $^\circ\text{C}$ |

¹ Includes input bias and offset current errors, RTO (referred to output).

² The input voltage range may also be limited by absolute maximum input voltage or by the output swing. See the Input Voltage Range section for details.

³ Internal resistors are trimmed to be ratio matched and have $\pm 20\%$ absolute accuracy.

⁴ Output voltage swing varies with supply voltage and temperature. See Figure 22 through Figure 25 for details.

⁵ Includes amplifier voltage and current noise, as well as noise from internal resistors.

⁶ Supply current varies with supply voltage and temperature. See Figure 26 and Figure 28 for details.

⁷ Unbalanced dual supplies can be used, such as $-V_S = -0.5\text{ V}$ and $+V_S = +2\text{ V}$. The positive supply rail must be at least 2 V above the negative supply and reference voltage.

$V_S = +2.7\text{ V}$ to $<\pm 5\text{ V}$, $V_{REF} = \text{midsupply}$, $T_A = 25^\circ\text{C}$, $R_L = 10\text{ k}\Omega$ connected to midsupply, $G = \frac{1}{2}$ difference amplifier configuration, unless otherwise noted.

Table 4.

| Parameter | Conditions | G = ½ | | | | | | Unit |
|--------------------------------------|---|-----------------|----------------|-----------------|-----------------|----------------|-----------------|---|
| | | Min | Grade B Typ | Max | Min | Grade A Typ | Max | |
| INPUT CHARACTERISTICS | | | | | | | | |
| System Offset ¹ | | | 75 | 150 | | 75 | 250 | μV |
| Over Temperature vs. Power Supply | $T_A = -40^\circ\text{C}$ to $+85^\circ\text{C}$ $V_S = \pm 5\text{ V}$ to $\pm 18\text{ V}$ | | | 150 | | | 250 | μV |
| Average Temperature Coefficient | $T_A = -40^\circ\text{C}$ to $+85^\circ\text{C}$ | | 0.3 | 1 | | 2 | 5 | $\mu\text{V}/^\circ\text{C}$ |
| Common-Mode Rejection Ratio (RTI) | $V_S = 2.7\text{ V}$, $V_{CM} = 0\text{ V}$ to 2.4 V , $R_S = 0\ \Omega$ $V_S = \pm 5\text{ V}$, $V_{CM} = -10\text{ V}$ to $+7\text{ V}$, $R_S = 0\ \Omega$ | 80 | | | 74 | | | dB |
| Input Voltage Range ² | | 80 | | | 74 | | | dB |
| Impedance ³ | | $-3(V_S + 0.1)$ | | $+3(V_S - 1.5)$ | $-3(V_S + 0.1)$ | | $+3(V_S - 1.5)$ | V |
| Differential | | | 120 | | | 120 | | k Ω |
| Common Mode | | | 30 | | | 30 | | k Ω |
| DYNAMIC PERFORMANCE | | | | | | | | |
| Bandwidth | | | 870 | | | 870 | | kHz |
| Slew Rate | | | 1.3 | | | 1.3 | | V/ μs |
| Channel Separation | $f = 1\text{ kHz}$ | | 130 | | | 130 | | dB |
| Settling Time to 0.01% | 2 V step on output, $C_L = 100\text{ pF}$, $V_S = 2.7\text{ V}$ | | 7 | | | 7 | | μs |
| GAIN | | | | | | | | |
| Gain Error | | | 0.005 | 0.02 | | 0.01 | 0.05 | % |
| Gain Drift | $T_A = -40^\circ\text{C}$ to $+85^\circ\text{C}$ | | | 1 | | | 5 | ppm/ $^\circ\text{C}$ |
| OUTPUT CHARACTERISTICS | | | | | | | | |
| Output Swing ⁴ | $R_L = 10\text{ k}\Omega$, $T_A = -40^\circ\text{C}$ to $+85^\circ\text{C}$ | $-V_S + 0.1$ | | $+V_S - 0.15$ | $-V_S + 0.1$ | | $+V_S - 0.15$ | V |
| Short-Circuit Current Limit | | | ± 10 | | | ± 10 | | mA |
| Capacitive Load Drive | | | 200 | | | 200 | | pF |
| NOISE ⁵ | | | | | | | | |
| Output Voltage Noise | $f = 0.1\text{ Hz}$ to 10 Hz $f = 1\text{ kHz}$ | | 1.4 | 50 | | 1.4 | 50 | $\mu\text{V p-p}$ nV/ $\sqrt{\text{Hz}}$ |
| POWER SUPPLY ⁶ | | | | | | | | |
| AD8278 Supply Current | $T_A = -40^\circ\text{C}$ to $+85^\circ\text{C}$ | | | 200 | | | 200 | μA |
| AD8279 Supply Current | $T_A = -40^\circ\text{C}$ to $+85^\circ\text{C}$ | | | 375 | | | 375 | μA |
| Operating Voltage Range | | 2.0 | | 36 | 2.0 | | 36 | V |
| TEMPERATURE RANGE | | | | | | | | |
| Operating Range | | -40 | | $+125$ | -40 | | $+125$ | $^\circ\text{C}$ |

¹ Includes input bias and offset current errors, RTO (referred to output).

² The input voltage range may also be limited by absolute maximum input voltage or by the output swing. See the Input Voltage Range section for details.

³ Internal resistors are trimmed to be ratio matched and have $\pm 20\%$ absolute accuracy.

⁴ Output voltage swing varies with supply voltage and temperature. See Figure 22 through Figure 25 for details.

⁵ Includes amplifier voltage and current noise, as well as noise from internal resistors.

⁶ Supply current varies with supply voltage and temperature. See Figure 27 and Figure 28 for details.

AD8278/AD8279

$V_S = +2.7\text{ V}$ to $<\pm 5\text{ V}$, $V_{REF} = \text{midsupply}$, $T_A = 25^\circ\text{C}$, $R_L = 10\text{ k}\Omega$ connected to midsupply, $G = 2$ difference amplifier configuration, unless otherwise noted.

Table 5.

| Parameter | Conditions | G = 2 | | | | | | Unit |
|-----------------------------------|---|-------------------|----------|-------------------|-------------------|----------|-------------------|------------------------------|
| | | Grade B | | | Grade A | | | |
| | | Min | Typ | Max | Min | Typ | Max | |
| INPUT CHARACTERISTICS | | | | | | | | |
| System Offset ¹ | | | 150 | 300 | | 150 | 500 | μV |
| Over Temperature vs. Power Supply | $T_A = -40^\circ\text{C}$ to $+85^\circ\text{C}$ $V_S = \pm 5\text{ V}$ to $\pm 18\text{ V}$ | | | 300 | | | 500 | μV |
| Average Temperature Coefficient | $T_A = -40^\circ\text{C}$ to $+85^\circ\text{C}$ | | 0.6 | 2 | | 3 | 5 | $\mu\text{V}/^\circ\text{C}$ |
| Common-Mode Rejection Ratio (RTI) | $V_S = 2.7\text{ V}$, $V_{CM} = 0\text{ V}$ to 2.4 V , $R_S = 0\ \Omega$ $V_S = \pm 5\text{ V}$, $V_{CM} = -10\text{ V}$ to $+7\text{ V}$, $R_S = 0\ \Omega$ | 86 | | | 80 | | | dB |
| Input Voltage Range ² | | 86 | | | 80 | | | dB |
| Impedance ³ | | $-1.5(V_S + 0.1)$ | | $+1.5(V_S - 1.5)$ | $-1.5(V_S + 0.1)$ | | $+1.5(V_S - 1.5)$ | V |
| Differential | | | 30 | | | 30 | | k Ω |
| Common Mode | | | 30 | | | 30 | | k Ω |
| DYNAMIC PERFORMANCE | | | | | | | | |
| Bandwidth | | | 450 | | | 450 | | kHz |
| Slew Rate | | | 1.3 | | | 1.3 | | V/ μs |
| Channel Separation | $f = 1\text{ kHz}$ | | 130 | | | 130 | | dB |
| Settling Time to 0.01% | 2 V step on output, $C_L = 100\text{ pF}$, $V_S = 2.7\text{ V}$ | | 9 | | | 9 | | μs |
| GAIN | | | | | | | | |
| Gain Error | | | 0.005 | 0.02 | | 0.01 | 0.05 | % |
| Gain Drift | $T_A = -40^\circ\text{C}$ to $+85^\circ\text{C}$ | | | 1 | | | 5 | ppm/ $^\circ\text{C}$ |
| OUTPUT CHARACTERISTICS | | | | | | | | |
| Output Swing ⁴ | $R_L = 10\text{ k}\Omega$, $T_A = -40^\circ\text{C}$ to $+85^\circ\text{C}$ | $-V_S + 0.1$ | | $+V_S - 0.15$ | $-V_S + 0.1$ | | $+V_S - 0.15$ | V |
| Short-Circuit Current Limit | | | ± 10 | | | ± 10 | | mA |
| Capacitive Load Drive | | | 200 | | | 200 | | pF |
| NOISE⁵ | | | | | | | | |
| Output Voltage Noise | $f = 0.1\text{ Hz}$ to 10 Hz $f = 1\text{ kHz}$ | | 2.8 | | | 2.8 | | $\mu\text{V p-p}$ |
| | | | 94 | 100 | | 94 | 100 | nV/ $\sqrt{\text{Hz}}$ |
| POWER SUPPLY⁶ | | | | | | | | |
| AD8278 Supply Current | $T_A = -40^\circ\text{C}$ to $+85^\circ\text{C}$ | | | 200 | | | 200 | μA |
| AD8279 Supply Current | $T_A = -40^\circ\text{C}$ to $+85^\circ\text{C}$ | | | 375 | | | 375 | μA |
| Operating Voltage Range | | 2.0 | | 36 | 2.0 | | 36 | V |
| TEMPERATURE RANGE | | | | | | | | |
| Operating Range | | -40 | | +125 | -40 | | +125 | $^\circ\text{C}$ |

¹ Includes input bias and offset current errors, RTO (referred to output).

² The input voltage range may also be limited by absolute maximum input voltage or by the output swing. See the Input Voltage Range section for details.

³ Internal resistors are trimmed to be ratio matched and have $\pm 20\%$ absolute accuracy.

⁴ Output voltage swing varies with supply voltage and temperature. See Figure 22 through Figure 25 for details.

⁵ Includes amplifier voltage and current noise, as well as noise from internal resistors.

⁶ Supply current varies with supply voltage and temperature. See Figure 27 and Figure 28 for details.

ABSOLUTE MAXIMUM RATINGS

Table 6.

| Parameter | Rating |
|--|---|
| Supply Voltage | $\pm 18\text{ V}$ |
| Maximum Voltage at Any Input Pin | $-V_S + 40\text{ V}$ |
| Minimum Voltage at Any Input Pin | $+V_S - 40\text{ V}$ |
| Storage Temperature Range | -65°C to $+150^\circ\text{C}$ |
| Specified Temperature Range | -40°C to $+85^\circ\text{C}$ |
| Package Glass Transition Temperature (T_G) | 150°C |

Stresses above those listed under Absolute Maximum Ratings may cause permanent damage to the device. This is a stress rating only; functional operation of the device at these or any other conditions above those indicated in the operational section of this specification is not implied. Exposure to absolute maximum rating conditions for extended periods may affect device reliability.

THERMAL RESISTANCE

The θ_{JA} values in Table 7 assume a 4-layer JEDEC standard board with zero airflow.

Table 7. Thermal Resistance

| Package Type | θ_{JA} | Unit |
|--------------|---------------|---------------------------|
| 8-Lead MSOP | 135 | $^\circ\text{C}/\text{W}$ |
| 8-Lead SOIC | 121 | $^\circ\text{C}/\text{W}$ |
| 14-Lead SOIC | 105 | $^\circ\text{C}/\text{W}$ |

MAXIMUM POWER DISSIPATION

The maximum safe power dissipation for the AD8278 and AD8279 are limited by the associated rise in junction temperature (T_J) on the die. At approximately 150°C , which is the glass transition temperature, the properties of the plastic change. Even temporarily exceeding this temperature limit may change the stresses that the package exerts on the die, permanently shifting the parametric performance of the amplifiers. Exceeding a temperature of 150°C for an extended period may result in a loss of functionality.



Figure 3. Maximum Power Dissipation vs. Ambient Temperature

SHORT-CIRCUIT CURRENT

The AD8278 and AD8279 have built-in, short-circuit protection that limits the output current (see Figure 29 for more information). While the short-circuit condition itself does not damage the part, the heat generated by the condition can cause the part to exceed its maximum junction temperature, with corresponding negative effects on reliability. Figure 3 and Figure 29, combined with knowledge of the supply voltages and ambient temperature of the part, can be used to determine whether a short circuit will cause the part to exceed its maximum junction temperature.

ESD CAUTION



ESD (electrostatic discharge) sensitive device. Charged devices and circuit boards can discharge without detection. Although this product features patented or proprietary protection circuitry, damage may occur on devices subjected to high energy ESD. Therefore, proper ESD precautions should be taken to avoid performance degradation or loss of functionality.

AD8278/AD8279

PIN CONFIGURATIONS AND FUNCTION DESCRIPTIONS



Figure 4. MSOP Pin Configuration



Figure 5. SOIC Pin Configuration

Table 8. AD8278 Pin Function Descriptions

| Pin No. | Mnemonic | Description |
|---------|----------|--------------------------|
| 1 | REF | Reference Voltage Input. |
| 2 | -IN | Inverting Input. |
| 3 | +IN | Noninverting Input. |
| 4 | -VS | Negative Supply. |
| 5 | SENSE | Sense Terminal. |
| 6 | OUT | Output. |
| 7 | +VS | Positive Supply. |
| 8 | NC | No Connect. |



Figure 6. 14-Lead SOIC Pin Configuration

Table 9. AD8279 Pin Function Descriptions

| Pin No. | Mnemonic | Description |
|---------|----------|------------------------------------|
| 1 | NC | No Connect. |
| 2 | -INA | Channel A Inverting Input. |
| 3 | +INA | Channel A Noninverting Input. |
| 4 | -VS | Negative Supply. |
| 5 | +INB | Channel B Noninverting Input. |
| 6 | -INB | Channel B Inverting Input. |
| 7 | NC | No Connect. |
| 8 | REFB | Channel B Reference Voltage Input. |
| 9 | OUTB | Channel B Output. |
| 10 | SENSEB | Channel B Sense Terminal. |
| 11 | +VS | Positive Supply. |
| 12 | SENSEA | Channel A Sense Terminal. |
| 13 | OUTA | Channel A Output. |
| 14 | REFA | Channel A Reference Voltage Input. |

TYPICAL PERFORMANCE CHARACTERISTICS

$V_S = \pm 15\text{ V}$, $T_A = 25^\circ\text{C}$, $R_L = 10\text{ k}\Omega$ connected to ground, $G = \frac{1}{2}$ difference amplifier configuration, unless otherwise noted.



Figure 7. Distribution of Typical System Offset Voltage, $G = 2$



Figure 10. System Offset vs. Temperature, Normalized at 25°C , $G = \frac{1}{2}$



Figure 8. Distribution of Typical Common-Mode Rejection, $G = 2$



Figure 11. Gain Error vs. Temperature, Normalized at 25°C , $G = \frac{1}{2}$



Figure 9. CMRR vs. Temperature, Normalized at 25°C , $G = \frac{1}{2}$



Figure 12. Input Common-Mode Voltage vs. Output Voltage, $\pm 15\text{ V}$ and $\pm 5\text{ V}$ Supplies, $G = \frac{1}{2}$



Figure 13. Input Common-Mode Voltage vs. Output Voltage, 5 V and 2.7 V Supplies, $V_{REF} = \text{Midsupply}$, $G = \frac{1}{2}$



Figure 16. Input Common-Mode Voltage vs. Output Voltage, 5 V and 2.7 V Supplies, $V_{REF} = \text{Midsupply}$, $G = 2$



Figure 14. Input Common-Mode Voltage vs. Output Voltage, 5 V and 2.7 V Supplies, $V_{REF} = 0V$, $G = \frac{1}{2}$



Figure 17. Input Common-Mode Voltage vs. Output Voltage, 5 V and 2.7 V Supplies, $V_{REF} = 0V$, $G = 2$



Figure 15. Input Common-Mode Voltage vs. Output Voltage, $\pm 15V$ and $\pm 5V$ Supplies, $G = 2$



Figure 18. Gain vs. Frequency, $\pm 15V$ Supplies



Figure 19. Gain vs. Frequency, +2.7 V Single Supply



Figure 22. Output Voltage Swing vs. Supply Voltage and Temperature, $R_L = 10\text{ k}\Omega$



Figure 20. CMRR vs. Frequency



Figure 23. Output Voltage Swing vs. Supply Voltage and Temperature, $R_L = 2\text{ k}\Omega$



Figure 21. PSRR vs. Frequency



Figure 24. Output Voltage Swing vs. R_L and Temperature, $V_S = \pm 15\text{ V}$



Figure 25. Output Voltage Swing vs. I_{OUT} and Temperature, $V_S = \pm 15\text{ V}$



Figure 28. Supply Current per Channel vs. Temperature

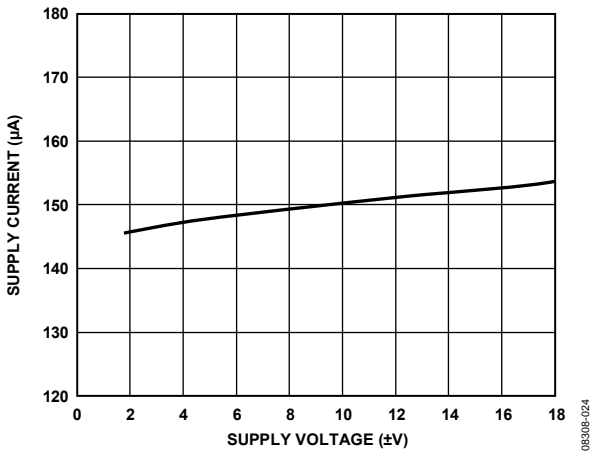

Figure 26. Supply Current per Channel vs. Dual-Supply Voltage, $V_{IN} = 0\text{ V}$

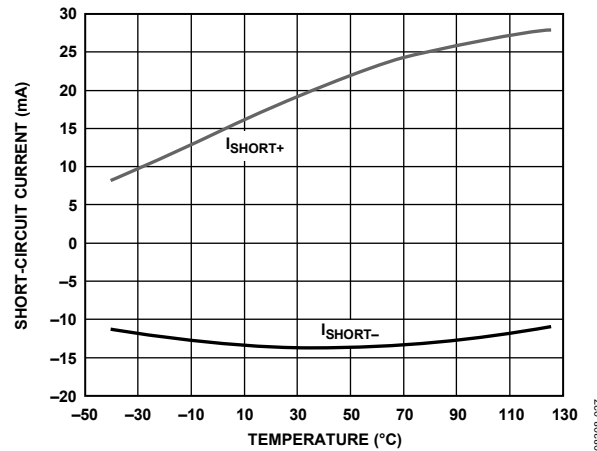

Figure 29. Short-Circuit Current per Channel vs. Temperature

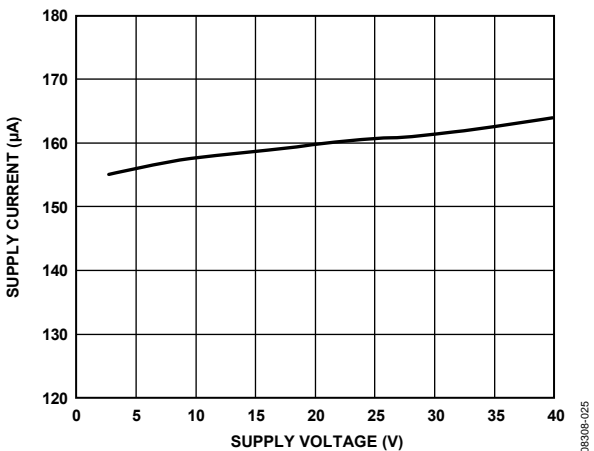

Figure 27. Supply Current per Channel vs. Single-Supply Voltage, $V_{IN} = 0\text{ V}$, $V_{REF} = 0\text{ V}$

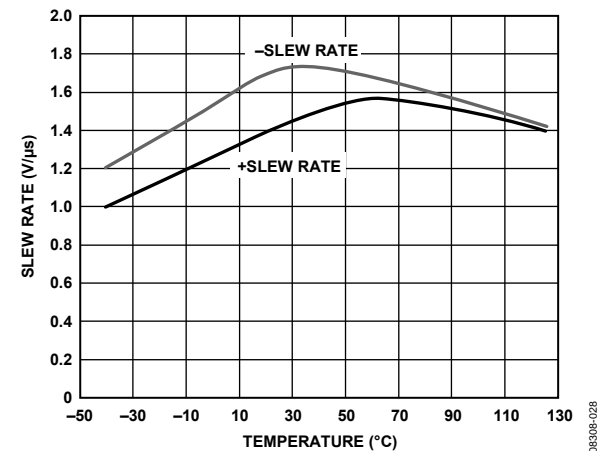

Figure 30. Slew Rate vs. Temperature, $V_{IN} = 20\text{ V p-p}$, 1 kHz



Figure 31. Gain Nonlinearity, $V_S = \pm 15\text{ V}$, $R_L \geq 2\text{ k}\Omega$, $G = \frac{1}{2}$



Figure 32. Gain Nonlinearity, $V_S = \pm 15\text{ V}$, $R_L \geq 2\text{ k}\Omega$, $G = 2$



Figure 33. Large Signal Pulse Response and Settling Time, 10 V Step, $V_S = \pm 15\text{ V}$, $G = \frac{1}{2}$



Figure 34. Large Signal Pulse Response and Settling Time, 2 V Step, $V_S = 2.7\text{ V}$, $G = \frac{1}{2}$



Figure 35. Large Signal Pulse Response and Settling Time, 10 V Step, $V_S = \pm 15\text{ V}$, $G = 2$



Figure 36. Large Signal Pulse Response and Settling Time, 2 V Step, $V_S = 2.7\text{ V}$



Figure 37. Large Signal Step Response, $G = \frac{1}{2}$



Figure 38. Large Signal Step Response, $G = 2$



Figure 39. Maximum Output Voltage vs. Frequency, $V_S = \pm 15\text{ V}$, $\pm 5\text{ V}$



Figure 40. Maximum Output Voltage vs. Frequency, $V_S = 5\text{ V}$, 2.7 V



Figure 41. Small Signal Step Response for Various Capacitive Loads, $G = \frac{1}{2}$



Figure 42. Small Signal Step Response for Various Capacitive Loads, $G = 2$



Figure 43. Small Signal Overshoot vs. Capacitive Load, $R_L \geq 2\text{ k}\Omega$, $G = \frac{1}{2}$



Figure 46. 0.1 Hz to 10 Hz Voltage Noise

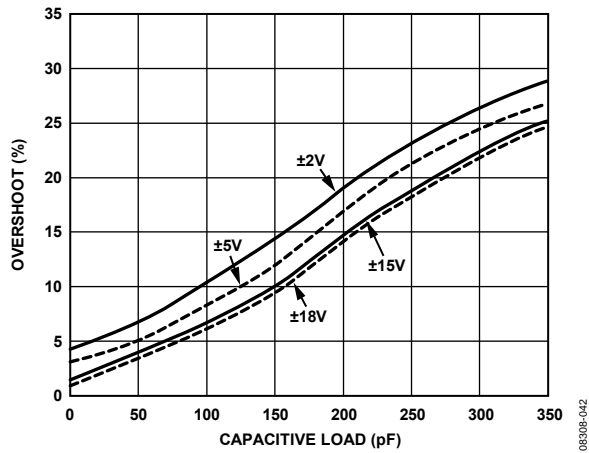

Figure 44. Small Signal Overshoot vs. Capacitive Load, $R_L \geq 2\text{ k}\Omega$, $G = 2$

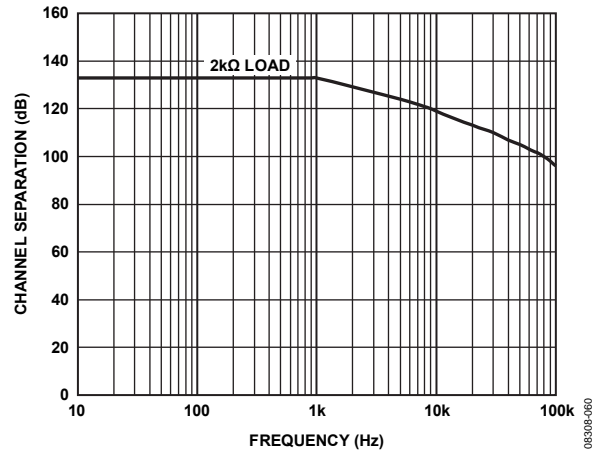

Figure 47. Channel Separation



Figure 45. Voltage Noise Density vs. Frequency

THEORY OF OPERATION

CIRCUIT INFORMATION

Each channel of the AD8278 and AD8279 consists of a low power, low noise op amp and four laser-trimmed on-chip resistors. These resistors can be externally connected to make a variety of amplifier configurations, including difference, noninverting, and inverting configurations. Taking advantage of the integrated resistors of the AD8278 and AD8279 provides the designer with several benefits over a discrete design, including smaller size, lower cost, and better ac and dc performance.



Figure 48. Functional Block Diagram

DC Performance

Much of the dc performance of op amp circuits depends on the accuracy of the surrounding resistors. Using superposition to analyze a typical difference amplifier circuit, as is shown in Figure 49, the output voltage is found to be

$$V_{OUT} = V_{IN+} \left(\frac{R2}{R1 + R2} \right) \left(1 + \frac{R4}{R3} \right) - V_{IN-} \left(\frac{R4}{R3} \right)$$

This equation demonstrates that the gain accuracy and common-mode rejection ratio of the AD8278 and AD8279 is determined primarily by the matching of resistor ratios. Even a 0.1% mismatch in one resistor degrades the CMRR to 69 dB for a $G = 2$ difference amplifier.

The difference amplifier output voltage equation can be reduced to

$$V_{OUT} = \frac{R4}{R3} (V_{IN+} - V_{IN-})$$

as long as the following ratio of the resistors is tightly matched:

$$\frac{R2}{R1} = \frac{R4}{R3}$$

The resistors on the AD8278 and AD8279 are laser trimmed to match accurately. As a result, the AD8278 and AD8279 provide superior performance over a discrete solution, enabling better CMRR, gain accuracy, and gain drift, even over a wide temperature range.

AC Performance

Component sizes and trace lengths are much smaller in an IC than on a PCB; therefore, the corresponding parasitic elements are also smaller. This results in better ac performance of the AD8278 and AD8279. For example, the positive and negative input terminals of the AD8278 and AD8279 op amps are intentionally not pinned out. By not connecting these nodes to the traces on the PCB, their capacitance remains low and balanced, resulting in improved loop stability and excellent common-mode rejection over frequency.

DRIVING THE AD8278 AND AD8279

Care should be taken to drive the AD8278 and AD8279 with a low impedance source, for example, another amplifier. Source resistance of even a few kilohms ($k\Omega$) can unbalance the resistor ratios and, therefore, significantly degrade the gain accuracy and common-mode rejection of the AD8278 and AD8279. Because all configurations present several kilohms ($k\Omega$) of input resistance, the AD8278 and AD8279 do not require a high current drive from the source and are easy to drive.

INPUT VOLTAGE RANGE

The AD8278 and AD8279 are able to measure input voltages beyond the supply rails. The internal resistors divide down the voltage before it reaches the internal op amp and provide protection to the op amp inputs. Figure 49 shows an example of how the voltage division works in a difference amplifier configuration. For the AD8278 and AD8279 to measure correctly, the input voltages at the input nodes of the internal op amp must stay below 1.5 V of the positive supply rail and can exceed the negative supply rail by 0.1 V. Refer to the Power Supplies section for more details.



Figure 49. Voltage Division in the Difference Amplifier Configuration

The AD8278 and AD8279 have integrated ESD diodes at the inputs that provide overvoltage protection. This feature simplifies system design by eliminating the need for additional external protection circuitry and enables a more robust system.

The voltages at any of the inputs of the parts can safely range from $+V_S - 40$ V up to $-V_S + 40$ V. For example, on ± 10 V supplies, input voltages can go as high as ± 30 V. Care should be taken to not exceed the $+V_S - 40$ V to $-V_S + 40$ V input limits to avoid damaging the parts.

POWER SUPPLIES

The AD8278 and AD8279 operate extremely well over a very wide range of supply voltages. They can operate on a single supply as low as 2 V and as high as 36 V, under appropriate setup conditions.

For best performance, the user should ensure that the internal op amp is biased correctly. The internal input terminals of the op amp must have sufficient voltage headroom to operate properly. Proper operation of the part requires at least 1.5 V between the positive supply rail and the op amp input terminals. This relationship is expressed in the following equation:

$$\frac{R1}{R1 + R2} V_{REF} < +V_S - 1.5 V$$

For example, when operating on a $+V_S = 2 V$ single supply and $V_{REF} = 0 V$, it can be seen from Figure 50 that the op amp input terminals are biased at 0 V, allowing more than the required 1.5 V headroom. However, if $V_{REF} = 1 V$ under the same conditions, the input terminals of the op amp are biased at 0.66 V ($G = \frac{1}{2}$). Now the op amp does not have the required 1.5 V headroom and cannot function. Therefore, the user must increase the supply voltage or decrease V_{REF} to restore proper operation.

The AD8278 and AD8279 are typically specified at single and dual supplies, but they can be used with unbalanced supplies as well; for example, $-V_S = -5 V$, $+V_S = +20 V$. The difference between the two supplies must be kept below 36 V. The positive supply rail must be at least 2 V above the negative supply.



Figure 50. Ensure Sufficient Voltage Headroom on the Internal Op Amp Inputs

Use a stable dc voltage to power the AD8278 and AD8279. Noise on the supply pins can adversely affect performance. Place a bypass capacitor of 0.1 μF between each supply pin and ground, as close as possible to each supply pin. Use a tantalum capacitor of 10 μF between each supply and ground. It can be farther away from the supply pins and, typically, it can be shared by other precision integrated circuits.

APPLICATIONS INFORMATION CONFIGURATIONS

The AD8278 and AD8279 can be configured in several ways (see Figure 51 to Figure 57). These configurations have excellent gain accuracy and gain drift because they rely on the internal matched resistors. Note that Figure 53 shows the AD8278 and AD8279 as difference amplifiers with a midsupply reference voltage at the noninverting input. This allows the AD8278 and AD8279 to be used as a level shifter, which is appropriate in single-supply applications that are referenced to midsupply. Table 10 lists several single-ended amplifier configurations that are not illustrated.



$$V_{OUT} = \frac{1}{2}(V_{IN+} - V_{IN-})$$

Figure 51. Difference Amplifier, Gain = 1/2



$$V_{OUT} = 2(V_{IN+} - V_{IN-})$$

Figure 52. Difference Amplifier, Gain = 2



$$V_{OUT} = \frac{1}{2}(V_{IN+} - V_{IN-}) + V_{REF}$$

Figure 53. Difference Amplifier, Gain = 1/2, Referenced to Midsupply



$$V_{OUT} = 2(V_{IN+} - V_{IN-}) + V_{REF}$$

Figure 54. Difference Amplifier, Gain = 2, Referenced to Midsupply



$$V_{OUT} = -\frac{1}{2}V_{IN}$$

Figure 55. Inverting Amplifier, Gain = -1/2



$$V_{OUT} = 1.5V_{IN}$$

Figure 56. Noninverting Amplifier, Gain = 1.5



$$V_{OUT} = 2V_{IN}$$

Figure 57. Noninverting Amplifier, Gain = 2

Table 10. AD8278 Difference and Single-Ended Amplifier Configurations

| Amplifier Configuration | Signal Gain | Pin 1 (REF) | Pin 2 (VIN-) | Pin 3 (VIN+) | Pin 5 (SENSE) |
|-------------------------------------|-------------|-------------|--------------|--------------|---------------|
| Difference Amplifier | +1/2 | GND | IN- | IN+ | OUT |
| Difference Amplifier | +2 | IN+ | OUT | GND | IN- |
| Single-Ended Inverting Amplifier | -1/2 | GND | IN | GND | OUT |
| Single-Ended Inverting Amplifier | -2 | GND | OUT | GND | IN |
| Single-Ended Noninverting Amplifier | +3/2 | IN | GND | IN | OUT |
| Single-Ended Noninverting Amplifier | +3 | IN | OUT | IN | GND |
| Single-Ended Noninverting Amplifier | +1/2 | GND | GND | IN | OUT |
| Single-Ended Noninverting Amplifier | +1 | IN | GND | GND | OUT |
| Single-Ended Noninverting Amplifier | +1 | GND | OUT | IN | GND |
| Single-Ended Noninverting Amplifier | +2 | IN | OUT | GND | GND |

The reference must be driven with a low impedance source to maintain the internal resistor ratio. An example using the low power, low noise OP1177 as a reference is shown in Figure 58.



Figure 58. Driving the Reference Pin

DIFFERENTIAL OUTPUT

The two difference amplifiers of the AD8279 can be configured to provide a differential output, as shown in Figure 59. This differential output configuration is suitable for various applications, such as strain gage excitation and single-ended-to-differential conversion. The differential output voltage has a gain twice that of a single AD8279 channel, as shown in the following equation:

$$V_{DIFF_OUT} = V_{+OUT} - V_{-OUT} = 2 \times G_{AD8279} \times (V_{IN+} - V_{IN-})$$

If the AD8279 amplifiers are each configured for $G = \frac{1}{2}$, the differential gain is $1\times$; if the AD8279 amplifiers are each configured for $G = 2$, the differential gain is $4\times$.



Figure 59. AD8279 Differential Output $G = 4$ Configuration

INSTRUMENTATION AMPLIFIER

The AD8278 and AD8279 can be used as building blocks for a low power, low cost instrumentation amplifier. An instrumentation amplifier provides high impedance inputs and delivers high common-mode rejection. Combining the AD8278 with an Analog Devices, Inc., low power amplifier (see Table 11) creates a precise, power efficient voltage measurement solution suitable for power critical systems.



Figure 60. Low Power Precision Instrumentation Amplifier

Table 11. Low Power Op Amps

| Op Amp (A1, A2) | Features |
|-----------------|---------------------------------------|
| AD8506 | Dual micropower op amp |
| AD8607 | Precision dual micropower op amp |
| AD8617 | Low cost CMOS micropower op amp |
| AD8667 | Dual precision CMOS micropower op amp |

It is preferable to use dual op amps for the high impedance inputs because they have better matched performance and track each other over temperature. The AD8278 and AD8279 difference amplifiers cancel out common-mode errors from the input op amps, if they track each other. The differential gain accuracy of the in-amp is proportional to how well the input feedback resistors (R_F) match each other. The CMRR of the in-amp increases as the differential gain is increased ($1 + 2R_F/R_G$), but a higher gain also reduces the common-mode voltage range.

Refer to *A Designer's Guide to Instrumentation Amplifiers* for more design ideas and considerations at www.analog.com, under Technical Documentation.

OUTLINE DIMENSIONS



COMPLIANT TO JEDEC STANDARDS MS-012-AA
 CONTROLLING DIMENSIONS ARE IN MILLIMETERS; INCH DIMENSIONS
 (IN PARENTHESES) ARE ROUNDED-OFF MILLIMETER EQUIVALENTS FOR
 REFERENCE ONLY AND ARE NOT APPROPRIATE FOR USE IN DESIGN.

Figure 61. 8-Lead Standard Small Outline Package [SOIC_N]
 Narrow Body (R-8)
 Dimensions shown in millimeters and (inches)

012407-A



COMPLIANT TO JEDEC STANDARDS MO-187-AA
 Figure 62. 8-Lead Mini Small Outline Package [MSOP]
 (RM-8)
 Dimensions shown in millimeters

10-07-2009-B



COMPLIANT TO JEDEC STANDARDS MS-012-AB
 CONTROLLING DIMENSIONS ARE IN MILLIMETERS; INCH DIMENSIONS
 (IN PARENTHESES) ARE ROUNDED-OFF MILLIMETER EQUIVALENTS FOR
 REFERENCE ONLY AND ARE NOT APPROPRIATE FOR USE IN DESIGN.

060606-A

Figure 63. 14-Lead Standard Small Outline Package [SOIC_N]
 Narrow Body (R-14)
 Dimensions shown in millimeters and (inches)

ORDERING GUIDE

| Model ¹ | Temperature Range | Package Description | Package Option | Branding |
|--------------------|-------------------|-----------------------------------|----------------|----------|
| AD8278ARZ | -40°C to +85°C | 8-Lead SOIC_N | R-8 | |
| AD8278ARZ-R7 | -40°C to +85°C | 8-Lead SOIC_N, 7" Tape and Reel | R-8 | |
| AD8278ARZ-RL | -40°C to +85°C | 8-Lead SOIC_N, 13" Tape and Reel | R-8 | |
| AD8278BRZ | -40°C to +85°C | 8-Lead SOIC_N | R-8 | |
| AD8278BRZ-R7 | -40°C to +85°C | 8-Lead SOIC_N, 7" Tape and Reel | R-8 | |
| AD8278BRZ-RL | -40°C to +85°C | 8-Lead SOIC_N, 13" Tape and Reel | R-8 | |
| AD8278ARMZ | -40°C to +85°C | 8-Lead MSOP | RM-8 | Y21 |
| AD8278ARMZ-R7 | -40°C to +85°C | 8-Lead MSOP, 7" Tape and Reel | RM-8 | Y21 |
| AD8278ARMZ-RL | -40°C to +85°C | 8-Lead MSOP, 13" Tape and Reel | RM-8 | Y21 |
| AD8278BRMZ | -40°C to +85°C | 8-Lead MSOP | RM-8 | Y22 |
| AD8278BRMZ-R7 | -40°C to +85°C | 8-Lead MSOP, 7" Tape and Reel | RM-8 | Y22 |
| AD8278BRMZ-RL | -40°C to +85°C | 8-Lead MSOP, 13" Tape and Reel | RM-8 | Y22 |
| AD8279ARZ | -40°C to +85°C | 14-Lead SOIC_N | R-14 | |
| AD8279ARZ-R7 | -40°C to +85°C | 14-Lead SOIC_N, 7" Tape and Reel | R-14 | |
| AD8279ARZ-RL | -40°C to +85°C | 14-Lead SOIC_N, 13" Tape and Reel | R-14 | |
| AD8279BRZ | -40°C to +85°C | 14-Lead SOIC_N | R-14 | |
| AD8279BRZ-R7 | -40°C to +85°C | 14-Lead SOIC_N, 7" Tape and Reel | R-14 | |
| AD8279BRZ-RL | -40°C to +85°C | 14-Lead SOIC_N, 13" Tape and Reel | R-14 | |

¹ Z = RoHS Compliant Part.

AD8278/AD8279

NOTES

NOTES

AD8278/AD8279

NOTES



Стандарт Электрон Связь

Мы молодая и активно развивающаяся компания в области поставок электронных компонентов. Мы поставляем электронные компоненты отечественного и импортного производства напрямую от производителей и с крупнейших складов мира.

Благодаря сотрудничеству с мировыми поставщиками мы осуществляем комплексные и плановые поставки широчайшего спектра электронных компонентов.

Собственная эффективная логистика и склад в обеспечивает надежную поставку продукции в точно указанные сроки по всей России.

Мы осуществляем техническую поддержку нашим клиентам и предпродажную проверку качества продукции. На все поставляемые продукты мы предоставляем гарантию .

Осуществляем поставки продукции под контролем ВП МО РФ на предприятия военно-промышленного комплекса России , а также работаем в рамках 275 ФЗ с открытием отдельных счетов в уполномоченном банке. Система менеджмента качества компании соответствует требованиям ГОСТ ISO 9001.

Минимальные сроки поставки, гибкие цены, неограниченный ассортимент и индивидуальный подход к клиентам являются основой для выстраивания долгосрочного и эффективного сотрудничества с предприятиями радиоэлектронной промышленности, предприятиями ВПК и научно-исследовательскими институтами России.

С нами вы становитесь еще успешнее!

Наши контакты:

Телефон: +7 812 627 14 35

Электронная почта: sales@st-electron.ru

Адрес: 198099, Санкт-Петербург,
Промышленная ул, дом № 19, литера Н,
помещение 100-Н Офис 331