

TRIUNE PRODUCTS

Features

- Ultra-low nA operating current at light load
- Best-in-class quiescent current of 20nA at Iload=0
- Best-in-class quiescent current of 100pA in disable mode
- Output voltage options of 1.2V - 4.2V in 100mV steps (programmed at manufacturing)
- Accurate output regulation
- Over-current protection

Summary Specifications

- Low input operating voltage of 2.5V to 5.5V
- Packaged in a 8pin DFN (2x2)
- Product is lead-free, Halogen Free, RoHS / WEEE compliant

Description

The TS14002 linear regulator is an ultra-low-power circuit which draws low nA level quiescent current at light load, but has the capability to regulate current loads as high as 150mA.

Applications

- Portable electronics
- RFID
- Industrial
- Medical
- Energy harvesting systems
- SmartCard

Typical Applications

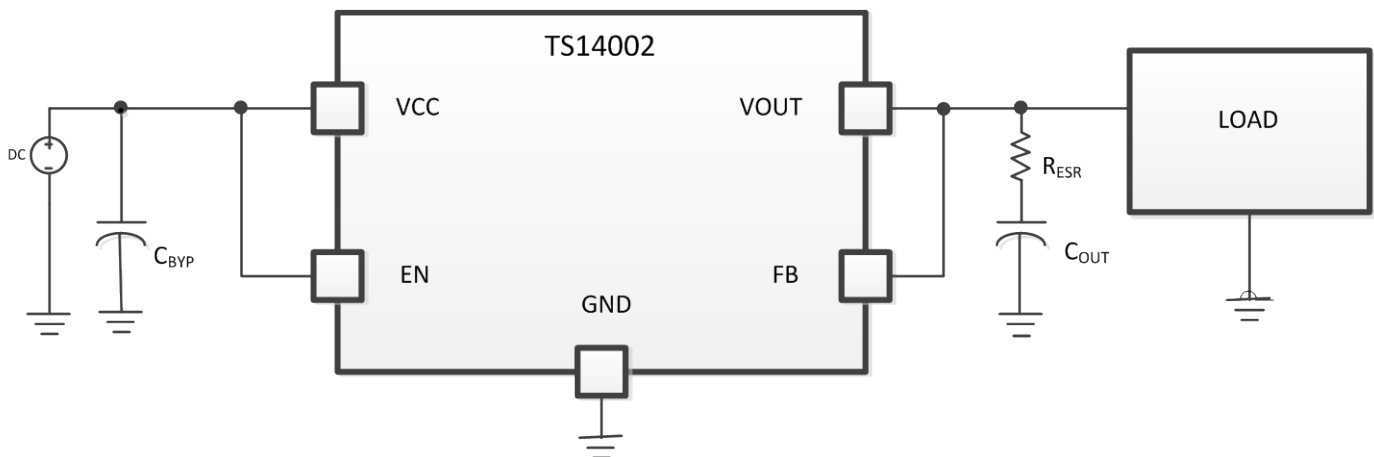

Block Diagram

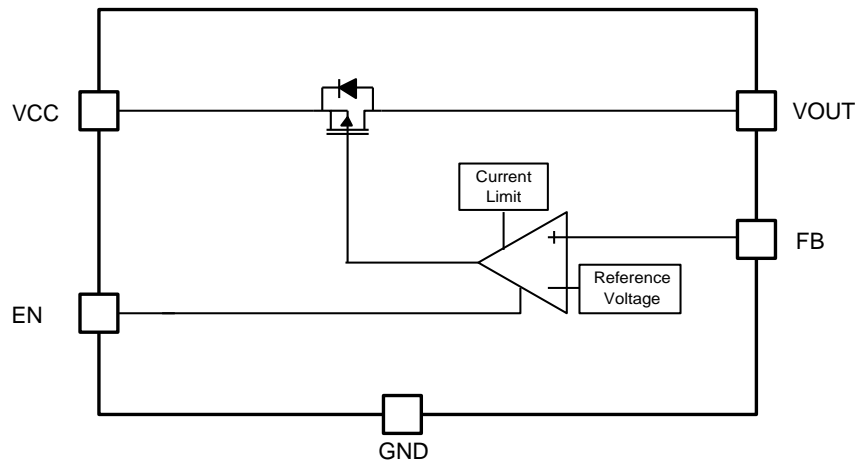

Pin Description

Pin #	Pin Name	Pin Type ⁽¹⁾	Description
1	GND	P	Ground
2	V _{OUT}	O	Regulated Output Voltage
3	NC		No Connect (connect to GND or float)
4	NC		No Connect (connect to GND or float)
5	NC		No Connect (connect to GND or float)
6	FB	I	Feedback Input
7	V _{CC}	P	Input Power
8	EN	I	Enable Input

(1) I = Input, O = Output, P = Power

Absolute Maximum Rating

Over operating free-air temperature range unless otherwise noted^(2, 3, 4)

Parameter	Value	Unit
V _{CC} , V _{OUT} , EN, FB	-0.3 to 6.0	V
Electrostatic Discharge (Human Body Model)	2	kV
Operating Junction Temperature Range, T _J	-40 to 85	°C
Storage Temperature Range, T _{STG}	-65 to 150	°C
Reflow Temperature (soldering, 10 seconds)	260	°C

(2) Stresses beyond those listed under “absolute maximum ratings” may cause permanent damage to the device. These are stress ratings only, and functional operation of the device at these or any other conditions beyond those indicated under “recommended operating conditions” is not implied. Exposure to absolute-maximum-rated conditions for extended periods may affect device reliability.

(3) All voltage values are with respect to network ground terminal.

(4) ESD testing is performed according to the respective JESD22 JEDEC standard.

Thermal Characteristics

Package DFN	θ_{JA} (°C/W) (See Note 5)	θ_{JC} (°C/W) (See Note 6)
8 pin	73.1	10.7

(5) This assumes a FR4 board only.

(6) This assumes a 1 Oz. Copper JEDEC standard board with thermal vias – See Exposed Pad section and application note for more information.

Recommended Operating Conditions

Parameter	Min	Typ	Max	Unit
Unregulated Supply Input Voltage (V_{CC})	2.5		5.5	V
Enable Input (EN)	0		5	V
Regulated Supply Output Voltage (V_{OUT}) typical	1.2		4.2	V
Operating Ambient Temperature, T_A (Note 7)	-40		55	°C
Operating Junction Temperature, T_J	-40		85	°C
Input Bypass Capacitor (C_{BYP})		2.2		uF
Output Bypass Capacitor (C_{OUT})	1	2.2	4.7	uF

(7) T_A Max shown here is a guideline. Higher T_A can be tolerated if T_J does not exceed the Absolute Maximum Rating.

Characteristics

Electrical characteristics, $V_{CC} = 2.5V$ to $5.5V$, $T_J = 25C$, $C_{OUT} = 2.2uF$ unless otherwise noted

Symbol	Parameter	Condition	Min	Typ	Max	Unit
V_{CC}	Input Supply Voltage		2.5		5.5	V
$V_{il_{EN}}$	Input Low Logic Level				$0.3 \cdot V_{CC}$	V
$V_{ih_{EN}}$	Input High Logic Level		$0.7 \cdot V_{CC}$			V
I_{qq}	Quiescent Current (note 9)	$V_{CC} = 2.5V$ to $5.5V$, $I_{OUT} = 0$ (Note 9)		20		nA
$I_{qq-disable}$	Quiescent Current: Disable Mode	$I_{OUT} = 0$, EN = 0		100		pA
I_{op-gnd}	Operating Current	$V_{CC} = V_{CC_MIN}$, $I_{OUT} = 150mA$ (Note 8)		200		uA
I_{out}	Load Capability	$V_{out_nominal}$ from 1.2V to 3.5V	0		150	mA
		$V_{out_nominal} > 3.5V$	0		100	

(8) If $V_{out_nominal} < 2.5V$, then $V_{CC_MIN} = 2.5V$, otherwise $V_{CC_MIN} = V_{out} + 0.3V$. V_{CC_MAX} is always 5.5V. V_{CC_NOM} is the average of V_{CC_MAX} and V_{CC_MIN} .

(9) Not tested in production, but has been evaluated on samples

Characteristics Continued

Electrical characteristics, $V_{CC} = 2.5V$ to $5.5V$, $T_J = 25C$, unless otherwise noted

Symbol	Parameter	Condition	Min	Typ	Max	Unit
V_{Line}	DC Line Regulation	$V_{CC} = V_{CC_MIN}$ to V_{CC_MAX} $V_{OUT} = 1.8V$ to $4.2V$, $I_{OUT} = 50mA$		0.5	4	%
		$V_{CC} = V_{CC_MIN}$ to V_{CC_MAX} $V_{OUT} < 1.8V$, $I_{OUT} = 50mA$			4	%
V_{Load}	DC Load Regulation	$V_{CC} = V_{CC_NOM}$ $I_{OUT} = 0.02mA$ to $150mA$,		1	3	%
I_{limit}	Short circuit current limit	V_{OUT} forced to GND (Note 9)	185	200		mA

(9) Not tested in production, but has been evaluated on samples

Typical Characteristics

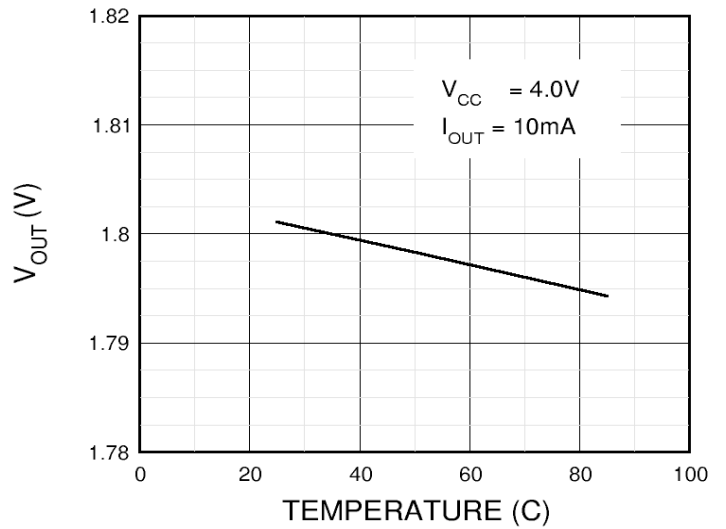
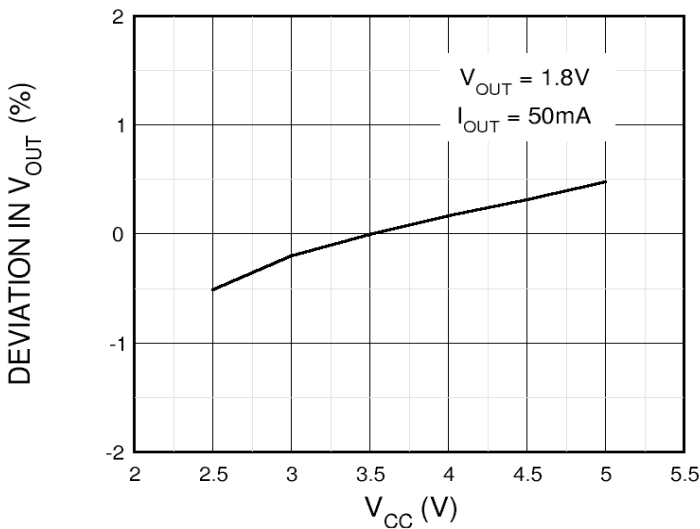
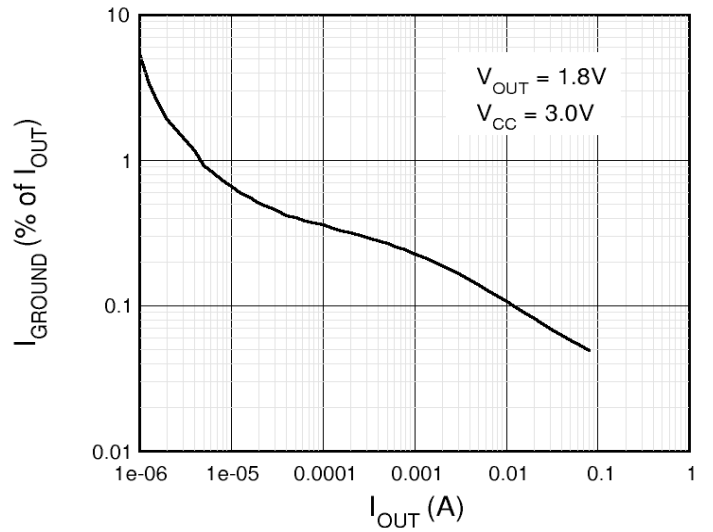
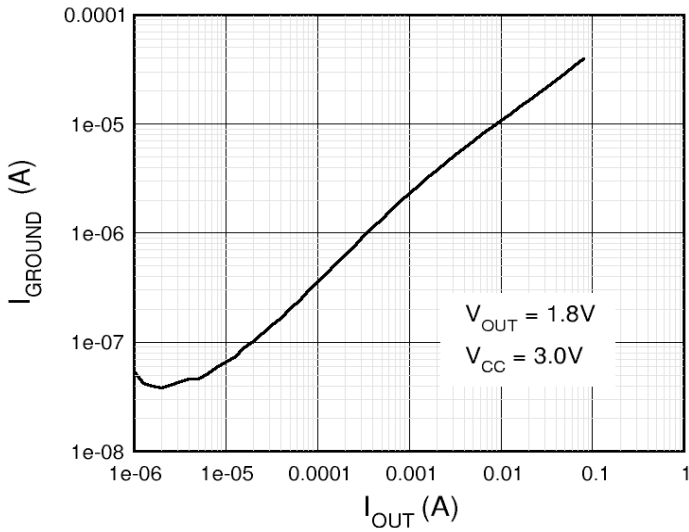
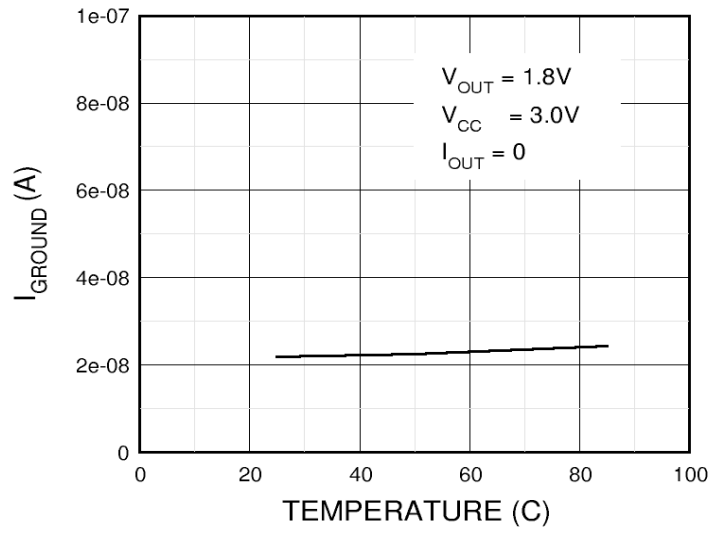
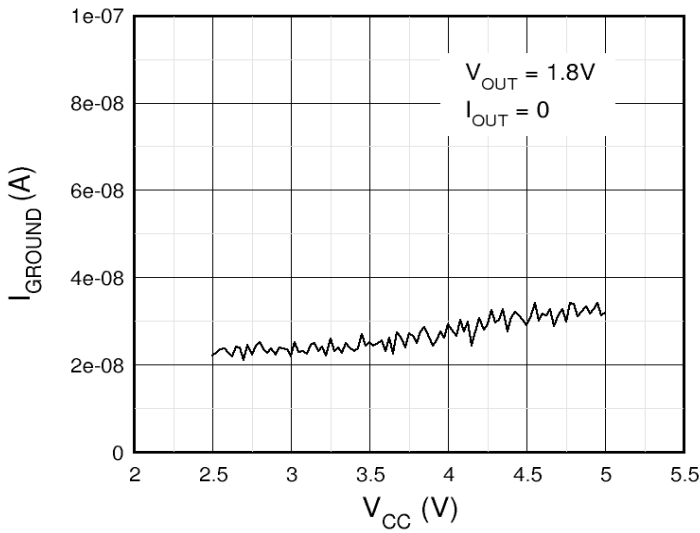

Dropout Voltage When V_{OUT} Drops By 3%

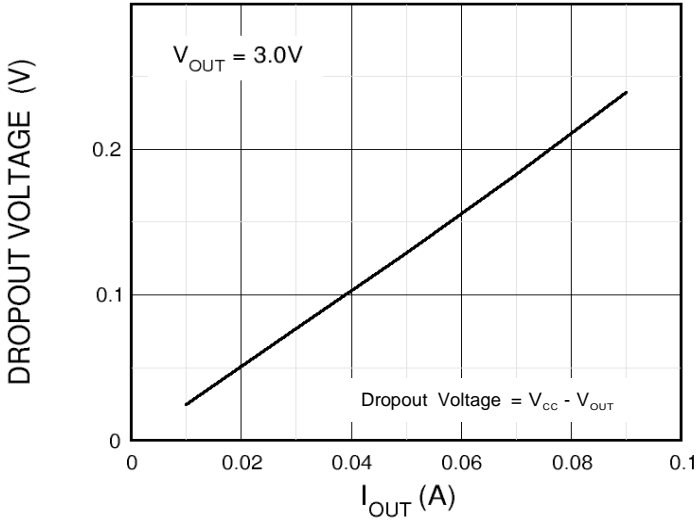

Load Regulation Performance

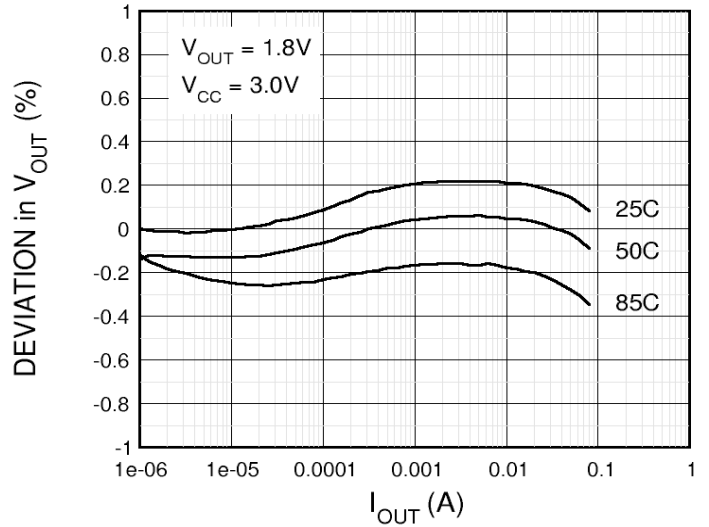

Load Step Response

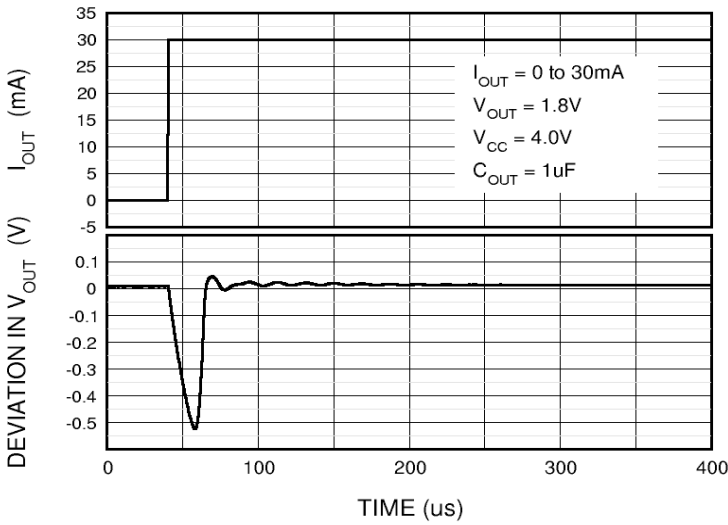

Load Step Response

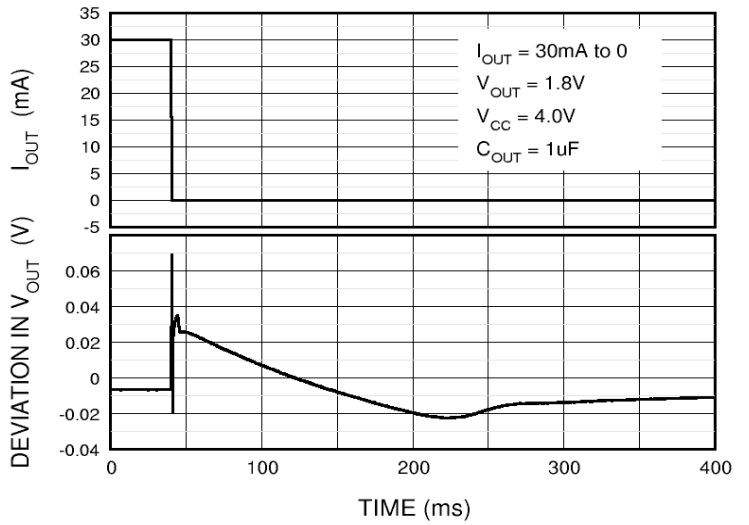

Load Step Response

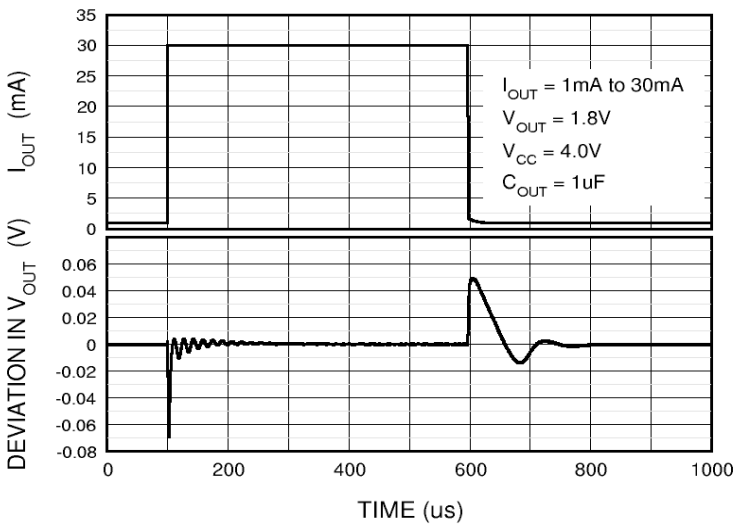

Line Step Response

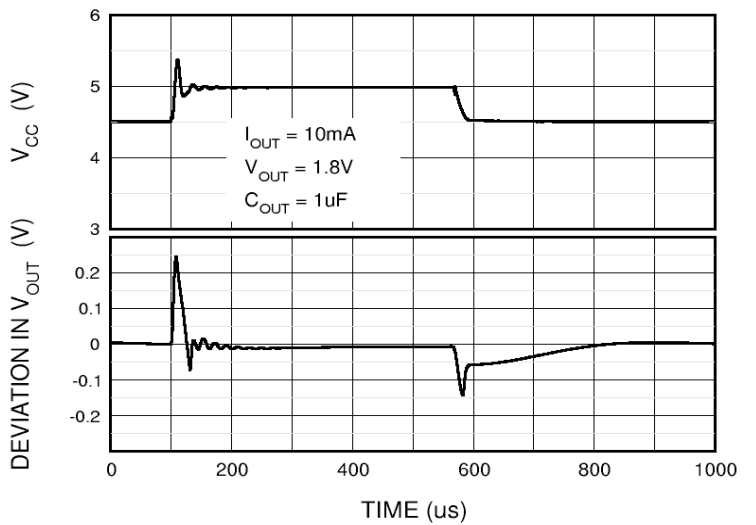

Output Enable Timing

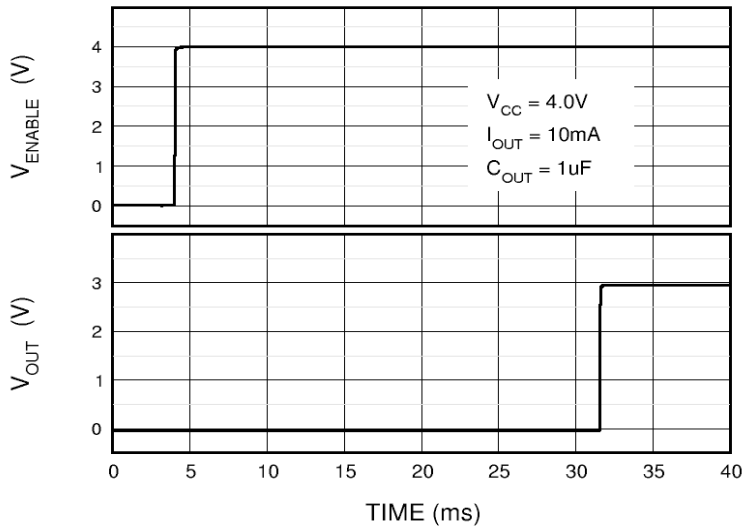

Power Supply Rejection Ratio

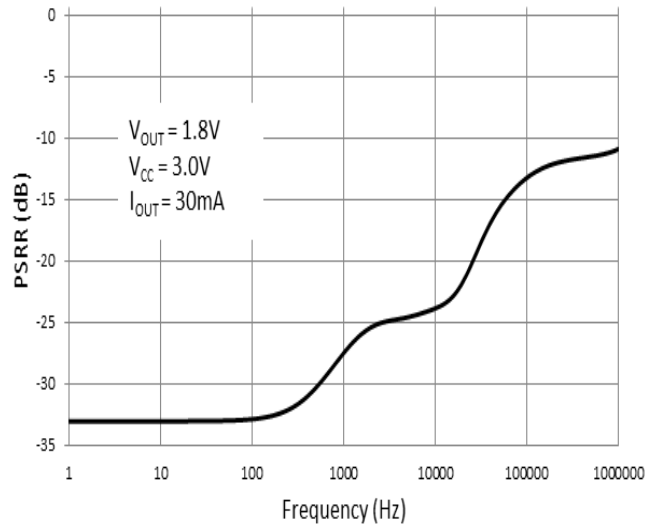

Package Mechanical Drawings (all dimensions in mm)

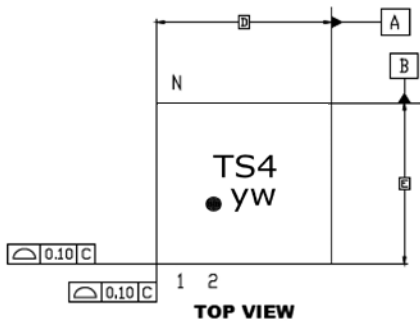

Marking for the 2.0 x 2.0 mm MLPD 8 Lead package:

nnn = Part Number (Example: TS4) - Reference Part No. Code for small MLP
 yw = Datecode (Reference Package Marking Design Guide lines, Appendix A)

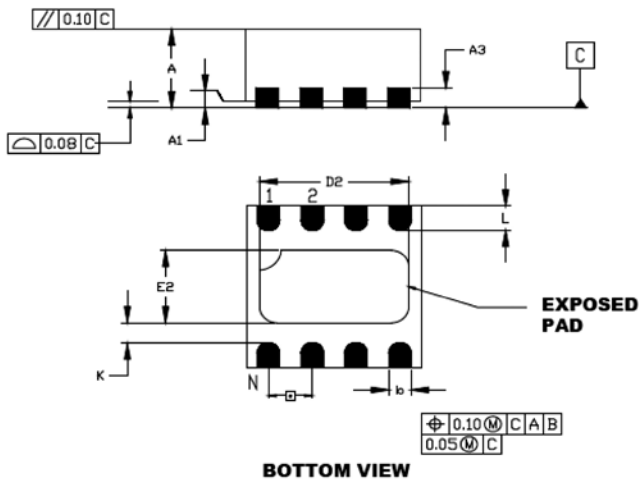

	Units	MILLIMETERS		
		Dimension Limits	MIN	NOM
Number of Pins	N	8		
Pitch	e	0.50 BSC		
Overall Height	A	0.80	0.90	1.00
Standoff	A1	0.00	0.02	0.05
Contact Thickness	A3	0.20 REF		
Overall Length	D	2.00 BSC		
Exposed Pad Width	E2	0.75	0.90	1.00
Overall Width	E	2.00 BSC		
Exposed Pad Length	D2	1.55	1.70	1.80
Contact Width	b	0.18	0.25	0.30
Contact Length	L	0.20	0.30	0.40
Contact-to-Exposed Pad	K	0.20	-	-

Notes:

Dimensions and tolerances per ASME Y14.5M.

BSC: Basic Dimension. Theoretically exact values shown without tolerances.

REF: Reference Dimension, usually without tolerance, for information only.

Recommended PCB Land Pattern

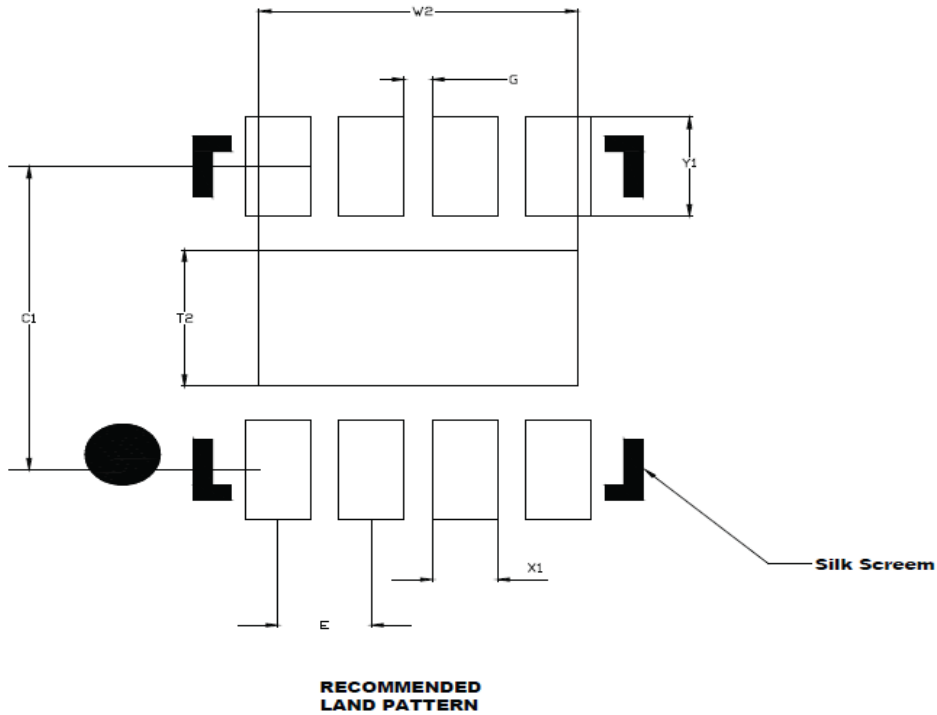

DIMENSIONS IN MILLIMETERS

	Units	MILLIMETERS		
		Dimension Limits	MIN	NOM
Contact Pitch	E		0.50 BSC	
Optional Center Pad Width	W2	-	-	1.70
Optional Center Pad Length	T2	-	-	0.90
Contact Pad Spacing	C1	-	2.00	-
Contact Pad Spacing	C2	-	-	-
Contact Pad Width (X8)	X1	-	-	0.35
Contact Pad Length (X8)	Y1	-	-	0.65
Distance Between Pads	G	0.15	-	-

Ordering Information

TS14002--CvvvDFNR

Part Number	Description
vvv	Output Voltage*
012	1.2 V
015	1.5 V
018	1.8 V
020	2.0 V
023	2.3 V
025	2.5 V
028	2.8 V
030	3.0 V
033	3.3 V
042	4.2 V

* Custom values also available (1.2V - 4.2V typical in 100mV increments)

IMPORTANT NOTICE

Information relating to this product and the application or design described herein is believed to be reliable, however such information is provided as a guide only and Semtech assumes no liability for any errors in this document, or for the application or design described herein. Semtech reserves the right to make changes to the product or this document at any time without notice. Buyers should obtain the latest relevant information before placing orders and should verify that such information is current and complete. Semtech warrants performance of its products to the specifications applicable at the time of sale, and all sales are made in accordance with Semtech's standard terms and conditions of sale.

SEMTECH PRODUCTS ARE NOT DESIGNED, INTENDED, AUTHORIZED OR WARRANTED TO BE SUITABLE FOR USE IN LIFE-SUPPORT APPLICATIONS, DEVICES OR SYSTEMS, OR IN NUCLEAR APPLICATIONS IN WHICH THE FAILURE COULD BE REASONABLY EXPECTED TO RESULT IN PERSONAL INJURY, LOSS OF LIFE OR SEVERE PROPERTY OR ENVIRONMENTAL DAMAGE. INCLUSION OF SEMTECH PRODUCTS IN SUCH APPLICATIONS IS UNDERSTOOD TO BE UNDERTAKEN SOLELY AT THE CUSTOMER'S OWN RISK. Should a customer purchase or use Semtech products for any such unauthorized application, the customer shall indemnify and hold Semtech and its officers, employees, subsidiaries, affiliates, and distributors harmless against all claims, costs damages and attorney fees which could arise.

The Semtech name and logo are registered trademarks of the Semtech Corporation. All other trademarks and trade names mentioned may be marks and names of Semtech or their respective companies. Semtech reserves the right to make changes to, or discontinue any products described in this document without further notice. Semtech makes no warranty, representation or guarantee, express or implied, regarding the suitability of its products for any particular purpose. All rights reserved.

© Semtech 2016

Contact Information

Semtech Corporation
200 Flynn Road, Camarillo, CA 93012
Phone: (805) 498-2111, Fax: (805) 498-3804
www.semtech.com



Стандарт Электрон Связь

Мы молодая и активно развивающаяся компания в области поставок электронных компонентов. Мы поставляем электронные компоненты отечественного и импортного производства напрямую от производителей и с крупнейших складов мира.

Благодаря сотрудничеству с мировыми поставщиками мы осуществляем комплексные и плановые поставки широчайшего спектра электронных компонентов.

Собственная эффективная логистика и склад в обеспечивает надежную поставку продукции в точно указанные сроки по всей России.

Мы осуществляем техническую поддержку нашим клиентам и предпродажную проверку качества продукции. На все поставляемые продукты мы предоставляем гарантию .

Осуществляем поставки продукции под контролем ВП МО РФ на предприятия военно-промышленного комплекса России , а также работаем в рамках 275 ФЗ с открытием отдельных счетов в уполномоченном банке. Система менеджмента качества компании соответствует требованиям ГОСТ ISO 9001.

Минимальные сроки поставки, гибкие цены, неограниченный ассортимент и индивидуальный подход к клиентам являются основой для выстраивания долгосрочного и эффективного сотрудничества с предприятиями радиоэлектронной промышленности, предприятиями ВПК и научно-исследовательскими институтами России.

С нами вы становитесь еще успешнее!

Наши контакты:

Телефон: +7 812 627 14 35

Электронная почта: sales@st-electron.ru

Адрес: 198099, Санкт-Петербург,
Промышленная ул, дом № 19, литера Н,
помещение 100-Н Офис 331