

Features

- Lead free as standard
- RoHS compliant*
- Leadless
- Low stored charge

Applications

- Cellular phones
- PDAs
- Desktop PCs and notebooks
- Digital cameras
- MP3 players



Use CD1005-xxxx products as an alternative.

Schottky Barrier Chip Diode Series - 0805

General Information

The markets of portable communications, computing and video equipment are challenging the semiconductor industry to develop increasingly smaller electronic components.

Bourns offers small-signal high-speed Schottky Barrier Diodes for switching and rectification applications, in compact chip package 0805 size format, which offer PCB real estate savings and are considerably smaller than competitive parts. The Schottky Barrier Diodes offer a forward current of 30 mA, 100 mA or 200 mA, a reverse voltage of 30 V, 40 V or 45V and also have a low forward voltage option. The diodes are lead-free with Cu/Ni/Au plated terminations and are compatible with lead-free manufacturing processes, conforming to many industry and government regulations on lead-free components.

Bourns® Chip Diodes conform to JEDEC standards, easy to handle on standard pick and place equipment and their flat configuration makes roll away much more difficult.

Electrical Characteristics (@ T_A = 25 °C Unless Otherwise Noted)

Parameter	Symbol	CD0805-B00340	CD0805-B0130	CD0805-B0130L	CD0805-B0145	CD0805-B0230	CD0805-B0245	Unit
Forward Voltage (Max.)	V _F	0.37 (I _f = 1 mA)	1.00 (I _f = 0.1 A)	0.44 (I _f = 0.1 A)	0.55 (I _f = 0.1 A)	0.50 (I _f = 0.2 A)	0.55 (I _f = 0.2 A)	V
Capacitance Between Terminals (Max.) (f = 1 MHz)	C _T	2 (V _r = 1 V)	6 (V _r = 10 V)	12 (V _r = 10 V)	6 (V _r = 10 V)	12 (V _r = 10 V)	12 (V _r = 10 V)	pF
Reverse Current (Max.)	I _R	1 (V _r = 40 V)	2 (V _r = 25 V)	30 (V _r = 30 V)	30 (V _r = 45 V)	30 (V _r = 30 V)	30 (V _r = 45 V)	μA

Absolute Ratings (@ T_A = 25 °C Unless Otherwise Noted)

Parameter	Symbol	CD0805-B00340	CD0805-B0130	CD0805-B0130L	CD0805-B0145	CD0805-B0230	CD0805-B0245	Unit
Repetitive Peak Reverse Voltage	V _{RRM}	45	30	35	50	35	50	V
Reverse Voltage	V _R	40	30	30	45	30	45	V
Average Forward Current	I _O	30	100	100	100	200	200	mA
Forward Current, Surge Peak	I _{surge}	500*	1000*	1000*	1000*	3000*	3000*	mA
Power Dissipation	PD	200	300	300	300	300	250	mW
Storage Temperature	T _{STG}	-40 to +125						°C
Junction Temperature	T _J	-40 to +125						°C

* Condition: 8.3 ms single half sine-wave superimposed on rate load (JEDEC method).

How To Order

CD 0805 - B 01 30 L

Common Code _____
Chip Diode

Package _____
• 0805

Model _____
B = Schottky Barrier Series

Average Forward Current (I_O) Code _____
003 = 30 mA
01 = 100 mA
02 = 200 mA
(Code x 1000 mA = Average Forward Current)

Reverse Voltage (V_R) Code _____
30 = 30 V
40 = 40 V
45 = 45 V

Forward Voltage Suffix _____
L = Low Forward Voltage V_f (CD0805-B0130L)

*RoHS Directive 2002/95/EC Jan 27 2003 including Annex Specifications are subject to change without notice. Customers should verify actual device performance in their specific applications.

Schottky Barrier Chip Diode Series - 0805

BOURNS®

Product Dimensions

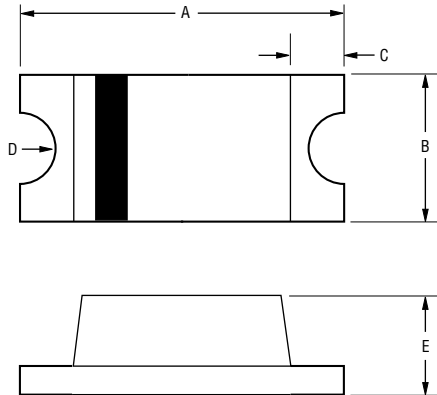

Dimension	0805
A	$\frac{2.00 - 2.20}{(0.079 - 0.087)}$
B	$\frac{1.20 - 1.40}{(0.047 - 0.055)}$
C	$\frac{0.40}{(0.016)}$ Typ.
D	$\frac{0.20}{(0.008)}$ R Typ.
E	$\frac{0.90 - 1.10}{(0.035 - 0.043)}$

DIMENSIONS: $\frac{\text{MM}}{\text{(INCHES)}}$

Recommended Pad Layout

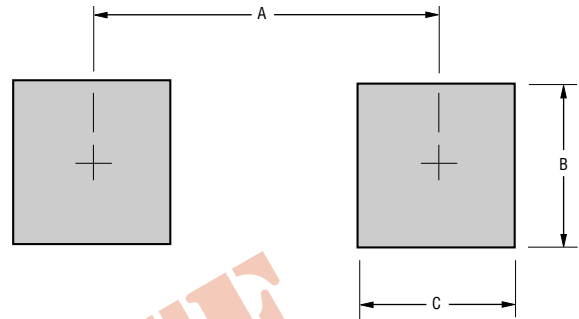

Dimension	0805
A (Max.)	$\frac{2.10}{(0.082)}$
B (Min.)	$\frac{1.20}{(0.047)}$
C (Min.)	$\frac{1.20}{(0.047)}$

DIMENSIONS: $\frac{\text{MM}}{\text{(INCHES)}}$

Physical Specifications

Case0805(2012) Molded plastic
 TerminalsSolder plated, solderable per MIL-STD-750, Method 2026
 PolarityIndicated by cathode band
 Mounting PositionAny
 Weight0.000159 ounces / 0.0045 grams

Typical Part Marking

CD0805-B00340B2
 CD0805-B0130B1
 CD0805-B0130LB3
 CD0805-B0145B4
 CD0805-B0230B5
 CD0805-B0245B6

Schottky Barrier Chip Diode Series - 0805

BOURNS®

Rating and Characteristic Curves: CD0805-B00340

Forward Characteristics

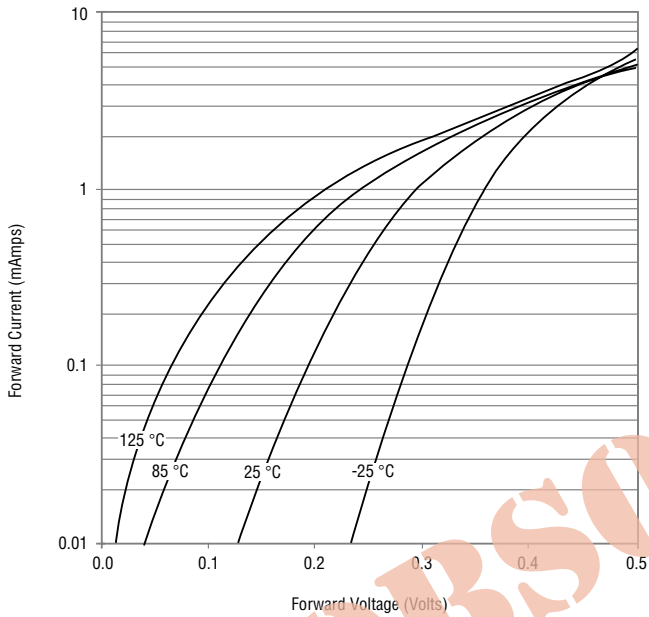

Reverse Characteristics

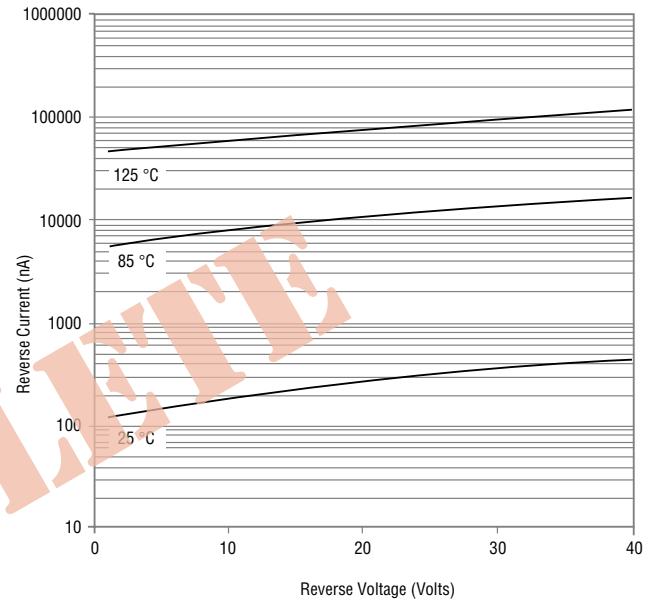

Derating Curve

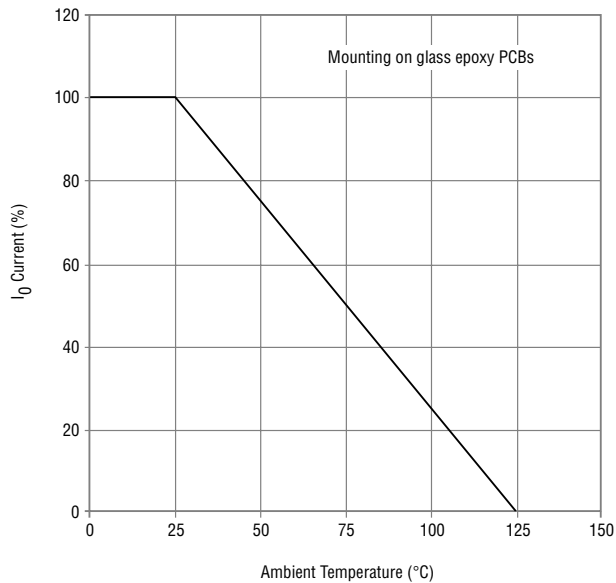

Capacitance Between Terminals

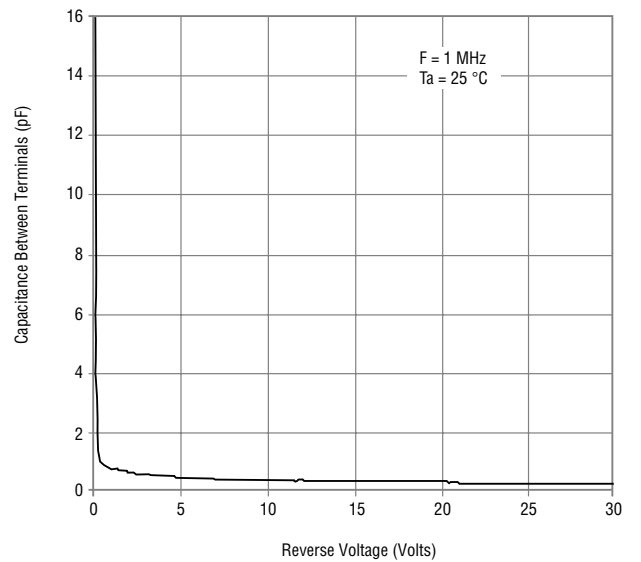

Schottky Barrier Chip Diode Series - 0805

BOURNS®

Rating and Characteristic Curves: CD0805-B0130

Forward Characteristics

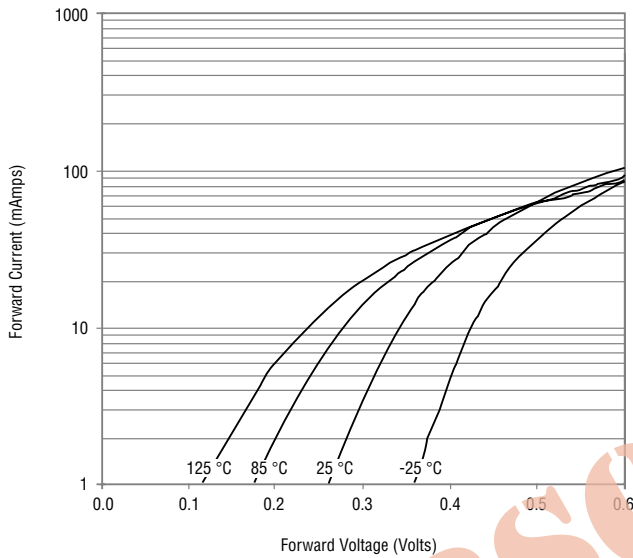

Reverse Characteristics

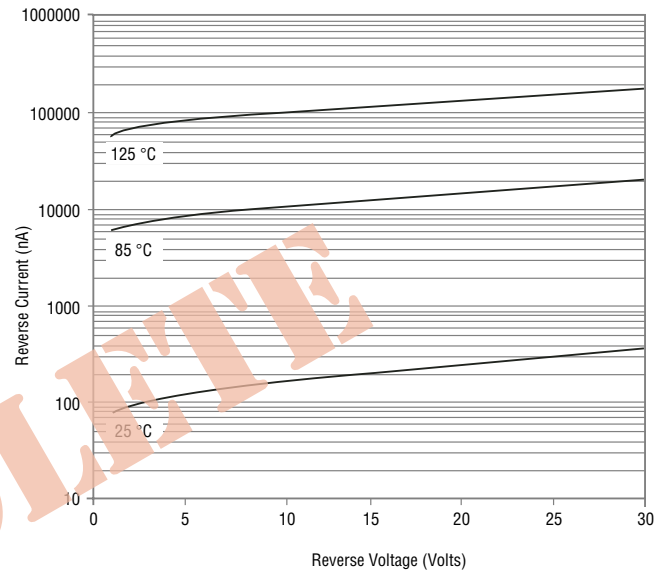

Derating Curve

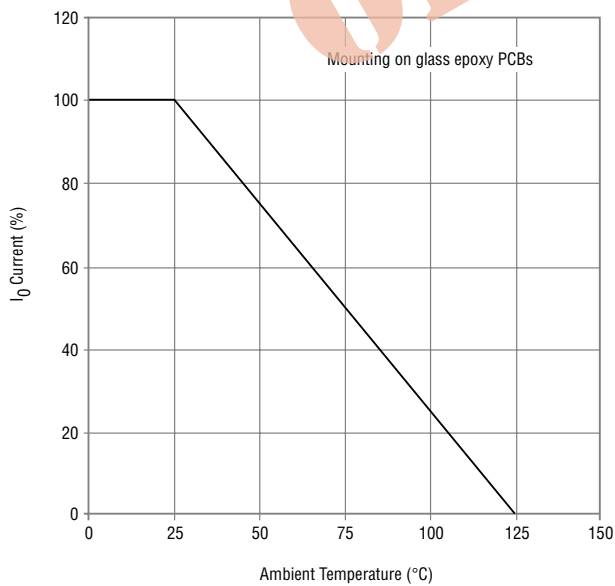

Capacitance Between Terminals

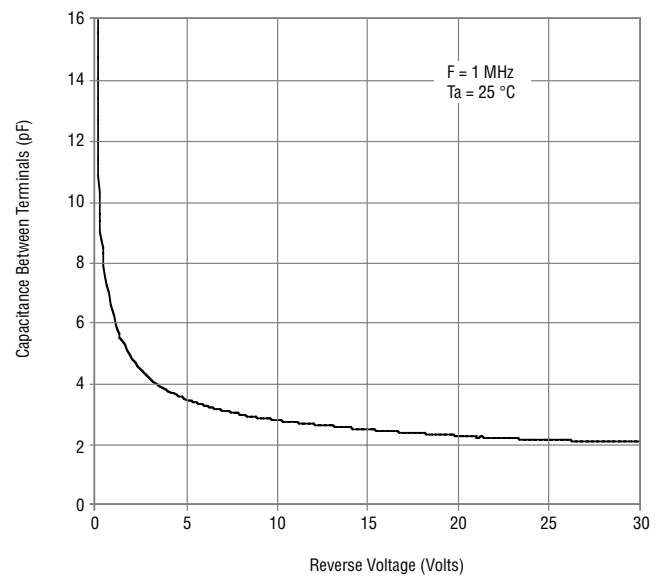

Schottky Barrier Chip Diode Series - 0805

BOURNS®

Rating and Characteristic Curves: CD0805-B0130L

Forward Characteristics

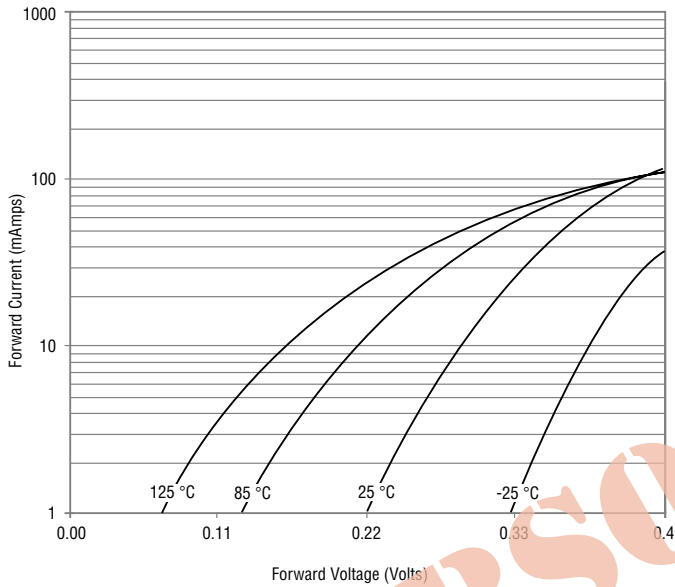

Reverse Characteristics

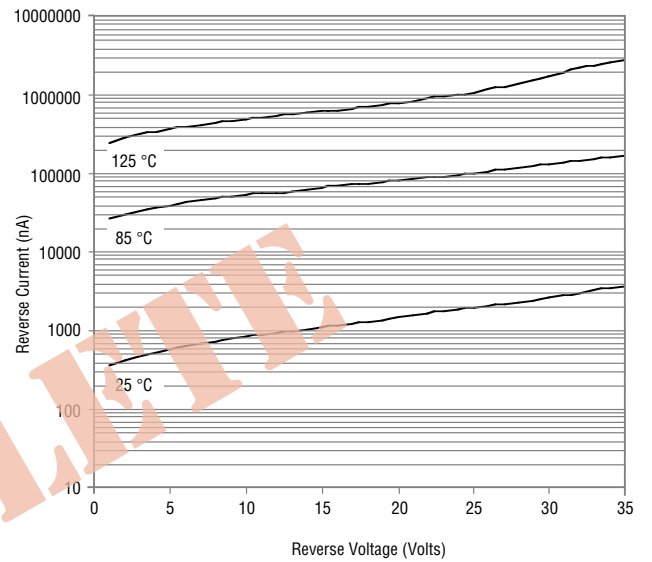

Derating Curve

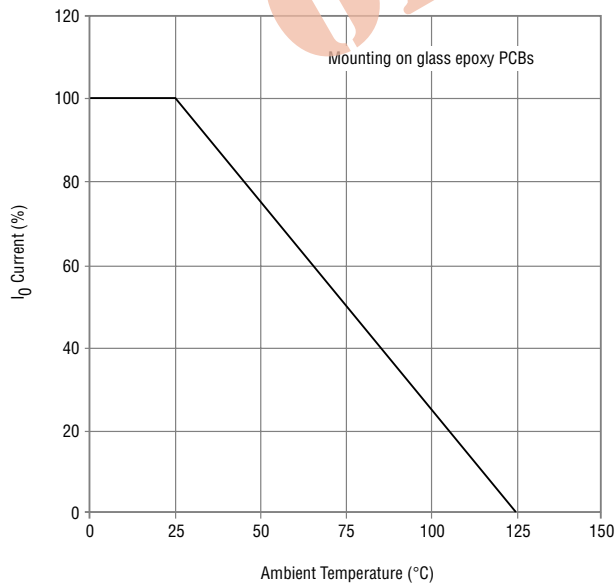

Capacitance Between Terminals

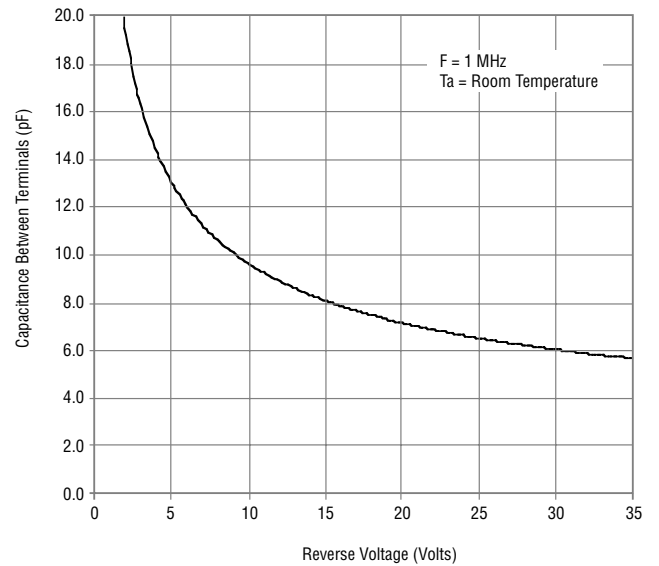

Schottky Barrier Chip Diode Series - 0805

BOURNS®

Rating and Characteristic Curves: CD0805-B0145

Forward Characteristics

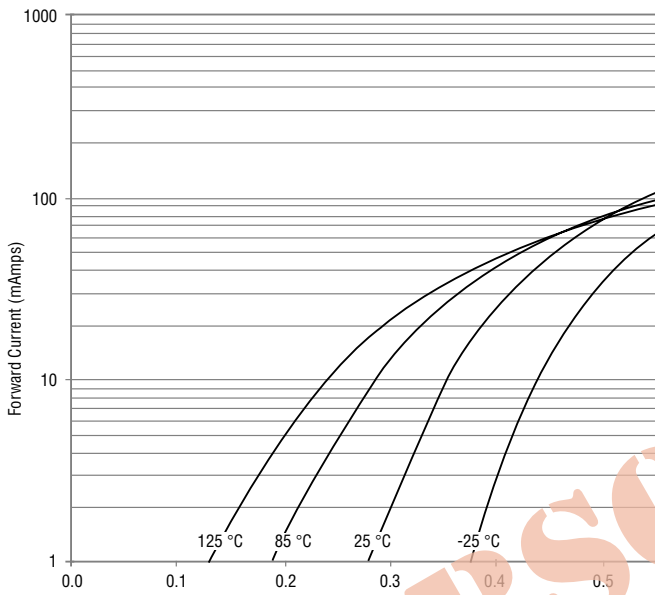

Reverse Characteristics

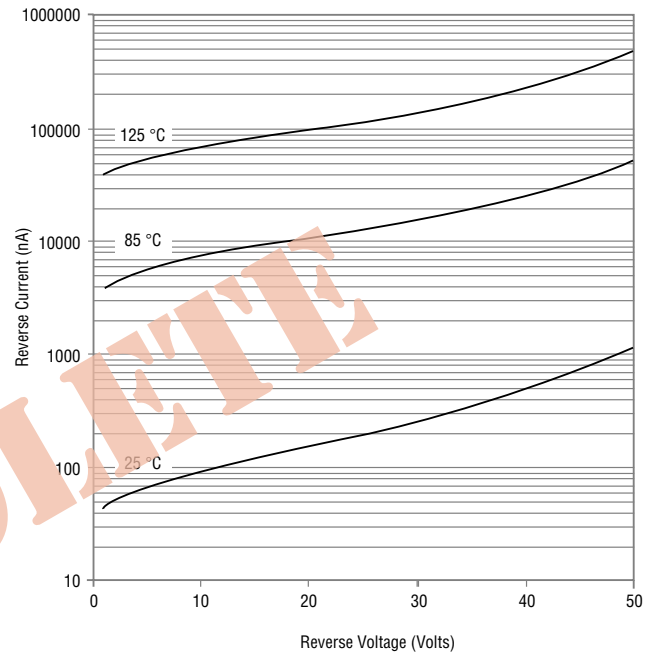

Derating Curve

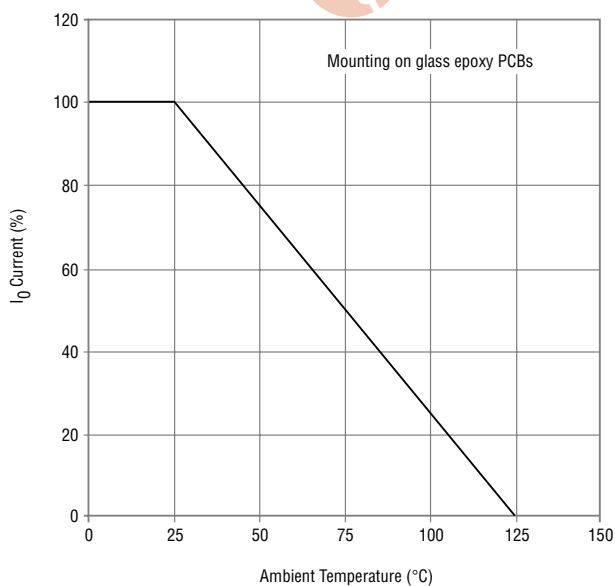

Capacitance Between Terminals

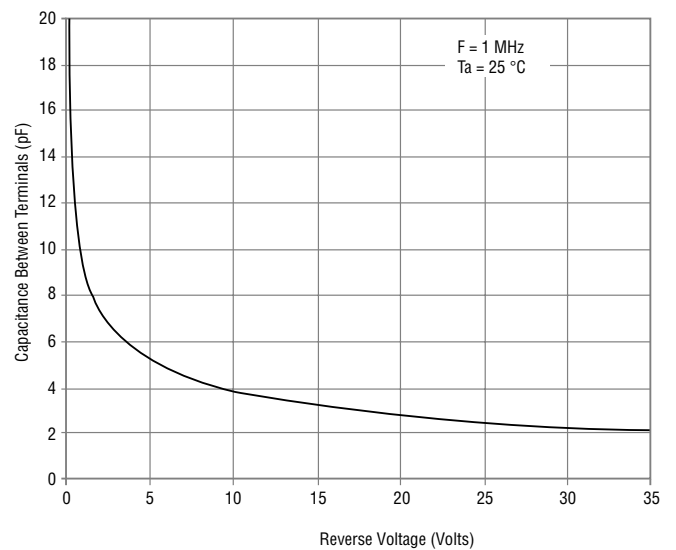

Schottky Barrier Chip Diode Series - 0805

BOURNS®

Rating and Characteristic Curves: CD0805-B0230

Forward Characteristics

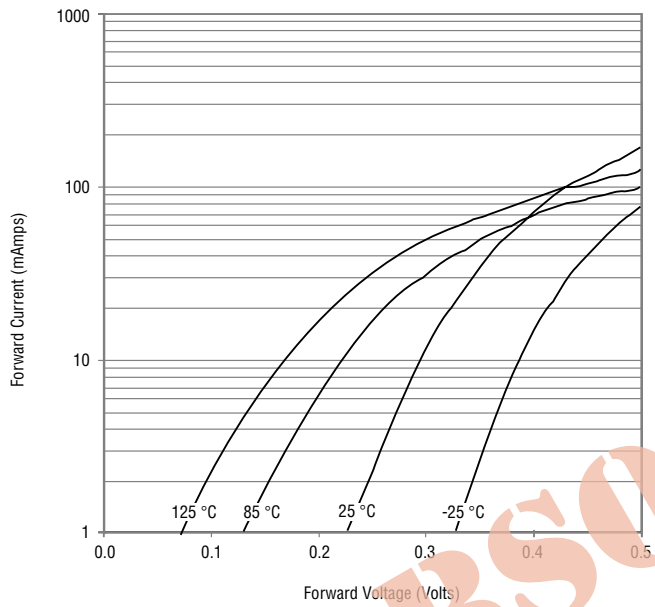

Reverse Characteristics

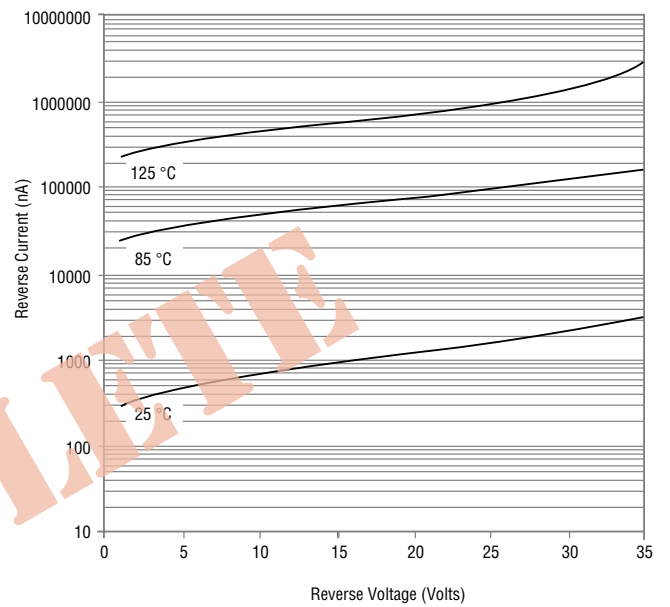

Derating Curve

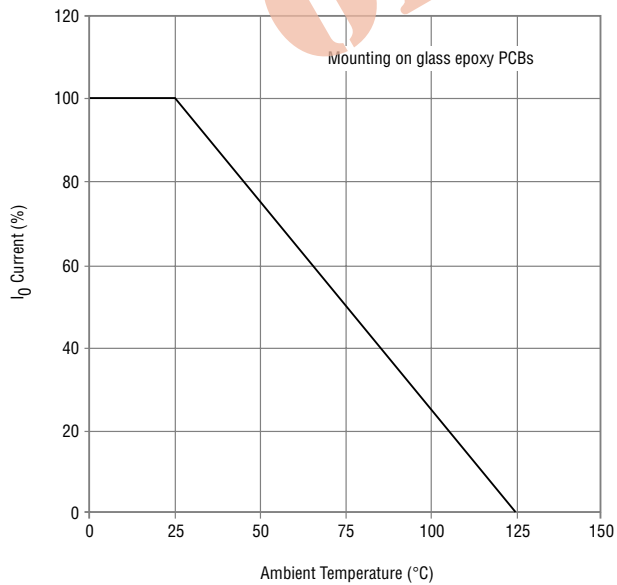

Capacitance Between Terminals

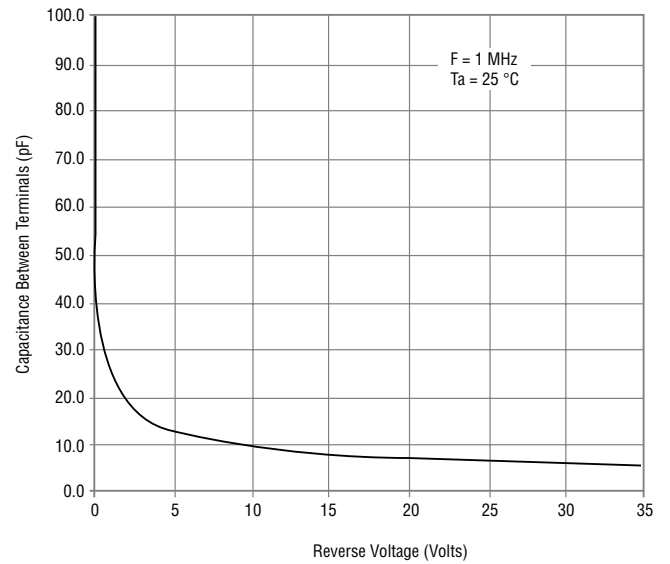

Schottky Barrier Chip Diode Series - 0805

BOURNS®

Rating and Characteristic Curves: CD0805-B0245

Forward Characteristics

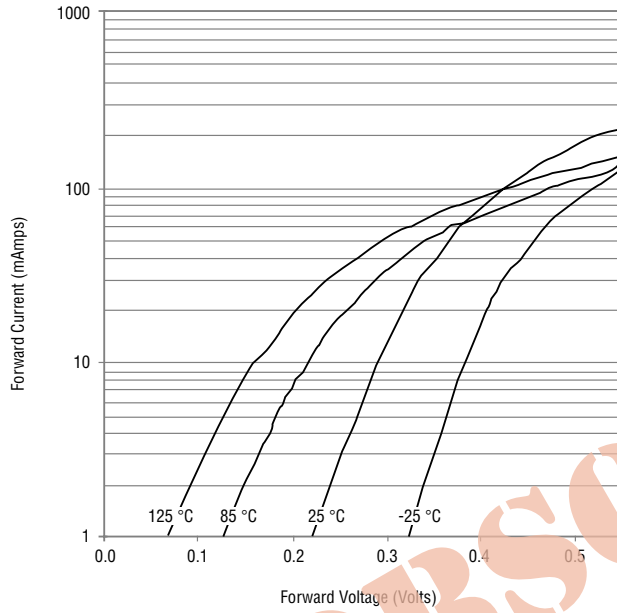

Reverse Characteristics

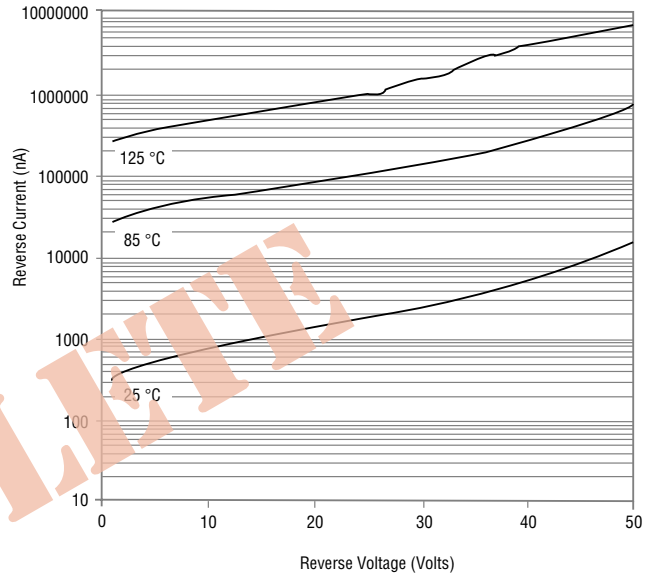

Derating Curve

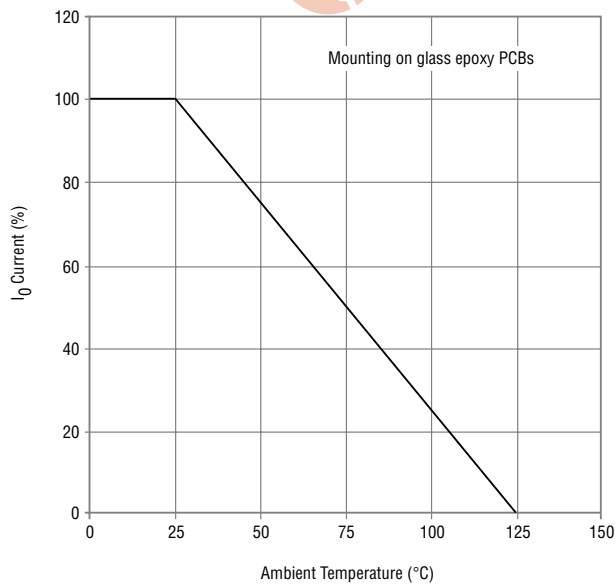

Capacitance Between Terminals

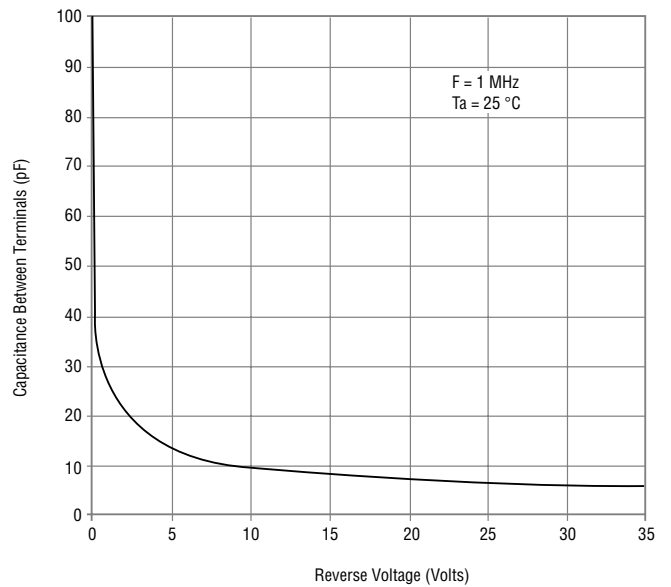

Schottky Barrier Chip Diode Series - 0805

BOURNS®

Packaging Information

The product will be dispensed in Tape and Reel format (see diagram below).

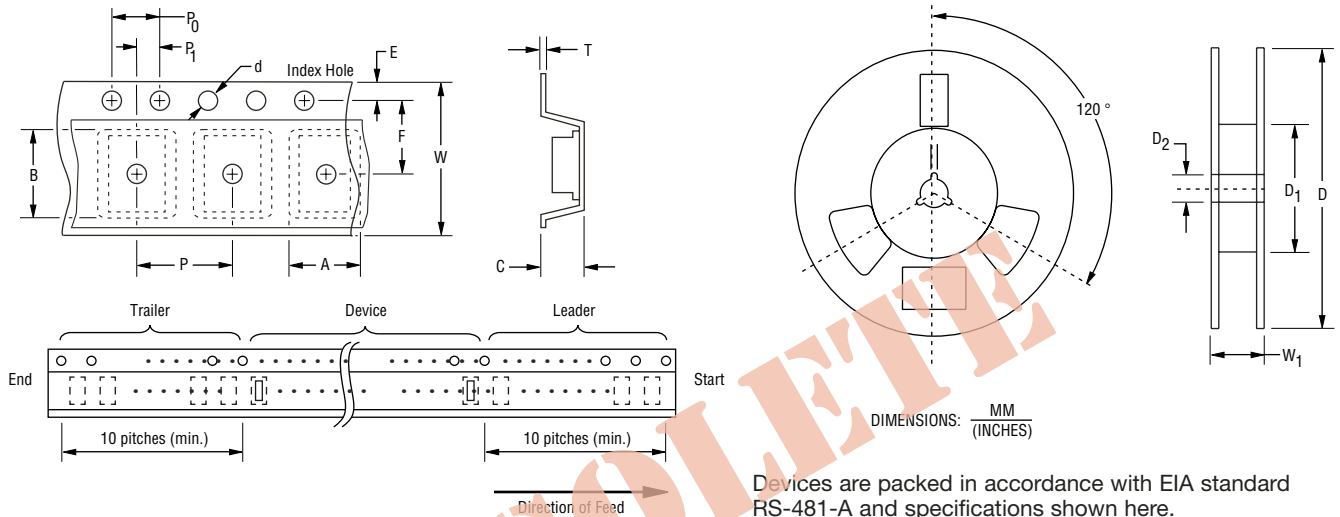

Devices are packed in accordance with EIA standard RS-481-A and specifications shown here.

Item	Symbol	0805
Carrier Width	A	$\frac{1.55 \pm 0.10}{(0.061 - 0.004)}$
Carrier Length	B	$\frac{2.30 \pm 0.10}{(0.091 - 0.004)}$
Carrier Depth	C	$\frac{1.25 \pm 0.10}{(0.049 - 0.004)}$
Sprocket Hole	d	$\frac{1.55 \pm 0.05}{(0.061 - 0.002)}$
Reel Outside Diameter	D	$\frac{178}{(7.008)}$
Reel Inner Diameter	D ₁	$\frac{60.0}{(2.362)}$ MIN.
Feed Hole Diameter	D ₂	$\frac{13.0 \pm 0.20}{(0.512 - 0.008)}$
Sprocket Hole Position	E	$\frac{1.75 \pm 0.10}{(0.069 - 0.004)}$
Punch Hole Position	F	$\frac{3.50 \pm 0.05}{(0.138 - 0.002)}$
Punch Hole Pitch	P	$\frac{4.00 \pm 0.10}{(0.157 - 0.004)}$
Sprocket Hole Pitch	P ₀	$\frac{4.00 \pm 0.10}{(0.157 - 0.004)}$
Embossment Center	P ₁	$\frac{2.00 \pm 0.05}{(0.079 - 0.002)}$
Overall Tape Thickness	T	$\frac{0.25 \pm 0.05}{(0.010 - 0.002)}$
Tape Width	W	$\frac{8.00 \pm 0.20}{(0.315 - 0.008)}$
Reel Width	W ₁	$\frac{13.5}{(0.531)}$ MAX.
Quantity per Reel	--	3,000



**Стандарт
Электрон
Связь**

Мы молодая и активно развивающаяся компания в области поставок электронных компонентов. Мы поставляем электронные компоненты отечественного и импортного производства напрямую от производителей и с крупнейших складов мира.

Благодаря сотрудничеству с мировыми поставщиками мы осуществляем комплексные и плановые поставки широчайшего спектра электронных компонентов.

Собственная эффективная логистика и склад в обеспечивает надежную поставку продукции в точно указанные сроки по всей России.

Мы осуществляем техническую поддержку нашим клиентам и предпродажную проверку качества продукции. На все поставляемые продукты мы предоставляем гарантию .

Осуществляем поставки продукции под контролем ВП МО РФ на предприятия военно-промышленного комплекса России , а также работаем в рамках 275 ФЗ с открытием отдельных счетов в уполномоченном банке. Система менеджмента качества компании соответствует требованиям ГОСТ ISO 9001.

Минимальные сроки поставки, гибкие цены, неограниченный ассортимент и индивидуальный подход к клиентам являются основой для выстраивания долгосрочного и эффективного сотрудничества с предприятиями радиоэлектронной промышленности, предприятиями ВПК и научно-исследовательскими институтами России.

С нами вы становитесь еще успешнее!

Наши контакты:

Телефон: +7 812 627 14 35

Электронная почта: sales@st-electron.ru

Адрес: 198099, Санкт-Петербург,
Промышленная ул, дом № 19, литера Н,
помещение 100-Н Офис 331