

CG2H40045

45 W, DC - 4 GHz RF Power GaN HEMT

Cree's CG2H40045 is an unmatched, gallium nitride (GaN) high electron mobility transistor (HEMT). The CG2H40045, operating from a 28 volt rail, offers a general purpose, broadband solution to a variety of RF and microwave applications. GaN HEMTs offer high efficiency, high gain and wide bandwidth capabilities making the CG2H40045 ideal for linear and compressed amplifier circuits. The transistor is available in a flange and pill package.

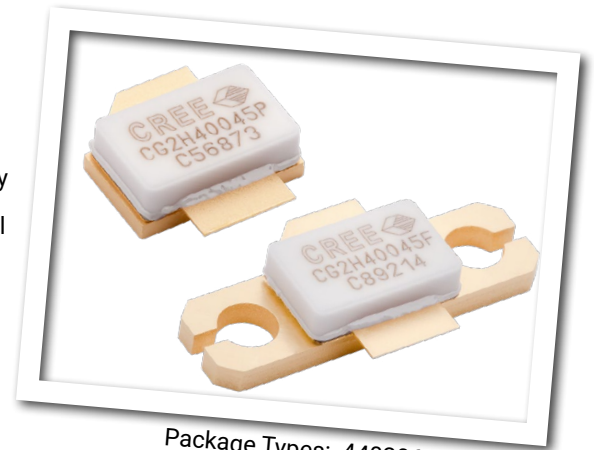

Package Types: 440206 & 440223
PN's: CG2H40045P & CG2H40045F

FEATURES

- Up to 4 GHz Operation
- 18 dB Small Signal Gain at 2.0 GHz
- 14 dB Small Signal Gain at 4.0 GHz
- 55 W Typical P_{SAT}
- 60 % Efficiency at P_{SAT}
- 28 V Operation

APPLICATIONS

- 2-Way Private Radio
- Broadband Amplifiers
- Cellular Infrastructure
- Test Instrumentation
- Class A, AB, Linear amplifiers suitable for OFDM, W-CDMA, EDGE, CDMA waveforms



Large Signal Models Available for ADS and MWO

Absolute Maximum Ratings (not simultaneous) at 25°C Case Temperature

Parameter	Symbol	Rating	Units	Conditions
Drain-Source Voltage	V_{DSS}	120	Volts	25°C
Gate-to-Source Voltage	V_{GS}	-10, +2	Volts	25°C
Storage Temperature	T_{STG}	-65, +150	°C	
Operating Junction Temperature	T_J	225	°C	
Maximum Forward Gate Current	I_{GMAX}	15	mA	25°C
Maximum Drain Current ¹	I_{DMAX}	6	A	25°C
Soldering Temperature ²	T_S	245	°C	
Screw Torque	τ	80	in-oz	
Thermal Resistance, Junction to Case ³	R_{JJC}	2.8	°C/W	85°C
Case Operating Temperature ^{3,4}	T_C	-40, +150	°C	

Note:

¹ Current limit for long term, reliable operation

² Refer to the Application Note on soldering at www.cree.com/RF/Document-Library

³ Measured for the CG2H40045F at $P_{DISS} = 56W$.

⁴ See also, the Power Dissipation De-rating Curve on Page 8.

Electrical Characteristics ($T_C = 25^\circ C$)

Characteristics	Symbol	Min.	Typ.	Max.	Units	Conditions
DC Characteristics¹						
Gate Threshold Voltage	$V_{GS(th)}$	-3.8	-3.0	-2.3	V_{DC}	$V_{DS} = 10 V, I_D = 14.4 mA$
Gate Quiescent Voltage	$V_{GS(Q)}$	-	-2.7	-	V_{DC}	$V_{DS} = 28 V, I_D = 400 mA$
Saturated Drain Current ²	I_{DS}	11.6	14.0	-	A	$V_{DS} = 6.0 V, V_{GS} = 2.0 V$
Drain-Source Breakdown Voltage	V_{BR}	120	-	-	V_{DC}	$V_{GS} = -8 V, I_D = 14.4 mA$
RF Characteristics³ ($T_C = 25^\circ C, F_0 = 2.5 GHz$ unless otherwise noted)						
Small Signal Gain	G_{SS}	15	17	-	dB	$V_{DD} = 28 V, I_{DQ} = 400 mA$
Power Output ⁴	P_{SAT}	47	55	-	W	$V_{DD} = 28 V, I_{DQ} = 400 mA$
Drain Efficiency ⁵	η	52	62	-	%	$V_{DD} = 28 V, I_{DQ} = 400 mA, P_{OUT} = P_{SAT}$
Output Mismatch Stress	VSWR	-	-	10 : 1	Ψ	No damage at all phase angles, $V_{DD} = 28 V, I_{DQ} = 400 mA,$ $P_{OUT} = 45 W CW$
Dynamic Characteristics						
Input Capacitance	C_{GS}	-	16.6	-	pF	$V_{DS} = 28 V, V_{GS} = -8 V, f = 1 MHz$
Output Capacitance	C_{DS}	-	6.3	-	pF	$V_{DS} = 28 V, V_{GS} = -8 V, f = 1 MHz$
Feedback Capacitance	C_{GD}	-	0.6	-	pF	$V_{DS} = 28 V, V_{GS} = -8 V, f = 1 MHz$

Notes:

¹ Measured on wafer prior to packaging.

² Scaled from PCM data.

³ Measured in CG2H40045F-AMP

⁴ P_{SAT} is defined as $I_G = 1.08 mA$.

⁵ Drain Efficiency = P_{OUT} / P_{DC}

Typical Performance

Figure 1. - Small Signal Gain and Input Return Loss of the CG2H40045F-AMP vs Frequency
 $V_{DD} = 28\text{ V}, I_{DQ} = 400\text{ mA}$

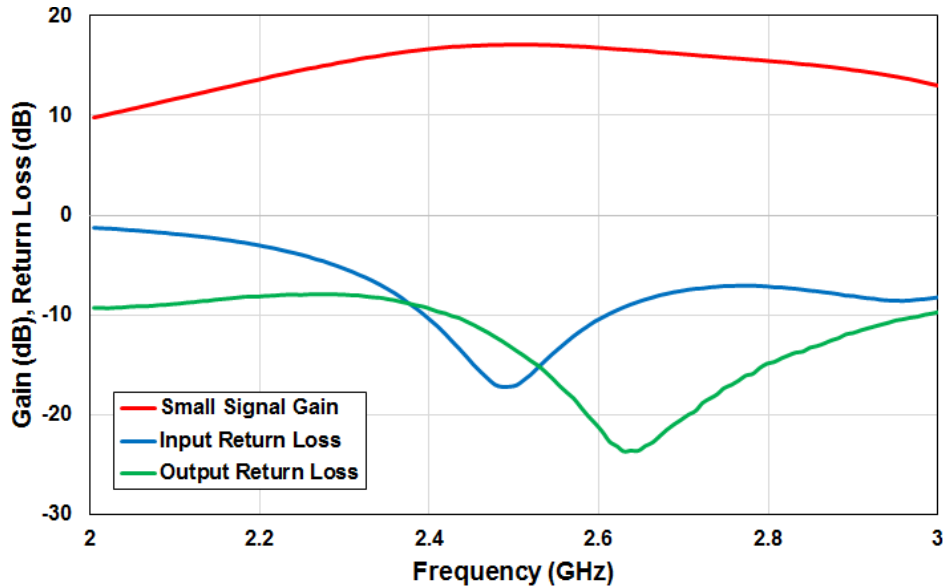
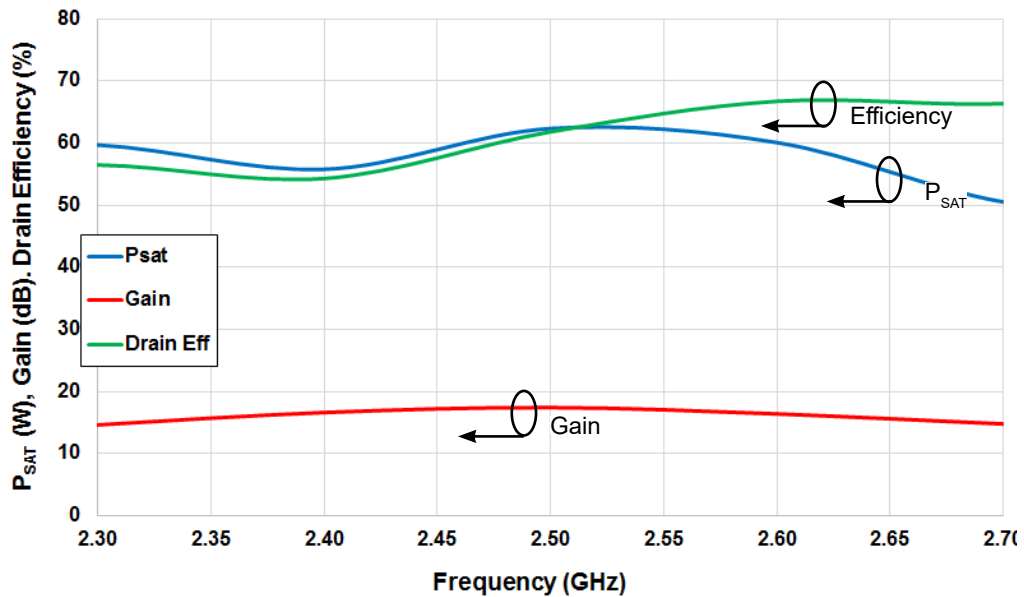

Figure 2. - Gain, Efficiency, and Output Power vs Frequency measured in Amplifier Circuit CG2H40045F-AMP
 $V_{DD} = 28\text{ V}, I_{DQ} = 400\text{ mA}$



Typical Performance

Figure 3. - Gain and Efficiency vs Output Power
 measured in Amplifier Circuit CG2H40045F-AMP
 $V_{DD} = 28\text{ V}$, $I_{DQ} = 400\text{ mA}$, Freq = 2.5 GHz

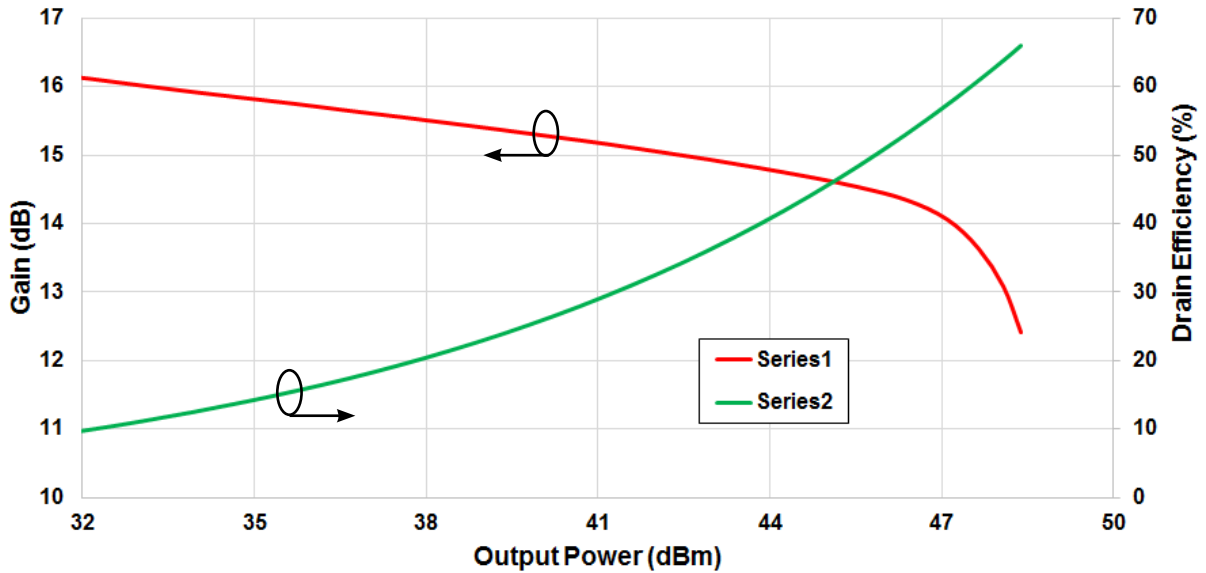
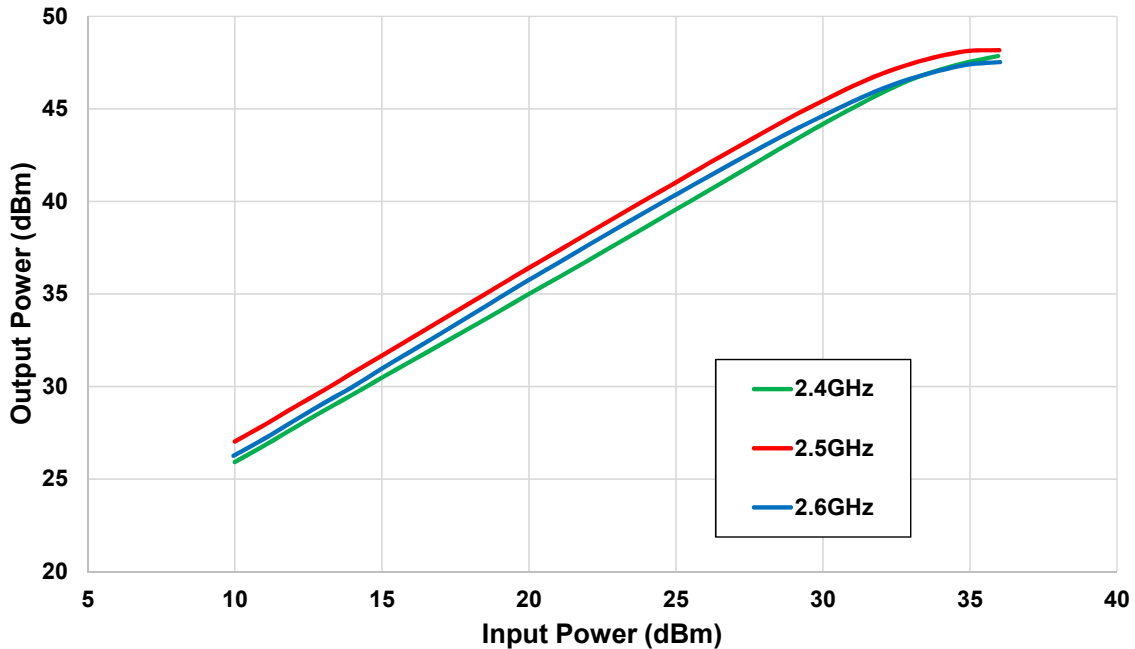

Figure 4. - Single Tone CW Output Power vs Input Power
 measured in Amplifier Circuit CG2H40045F-AMP
 $V_{DD} = 28\text{ V}$, $I_{DQ} = 400\text{ mA}$



Typical Performance

Figure 5. - Maximum Available Gain and K Factor of the CG2H40045
 $V_{DD} = 28\text{ V}, I_{DQ} = 400\text{ mA}$

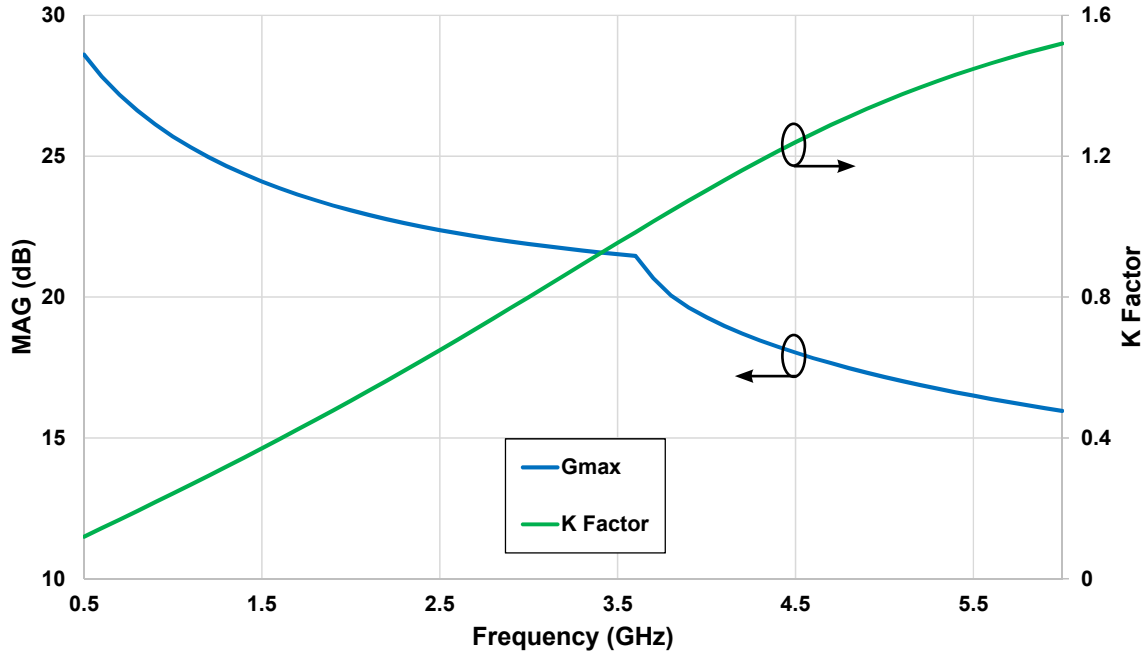
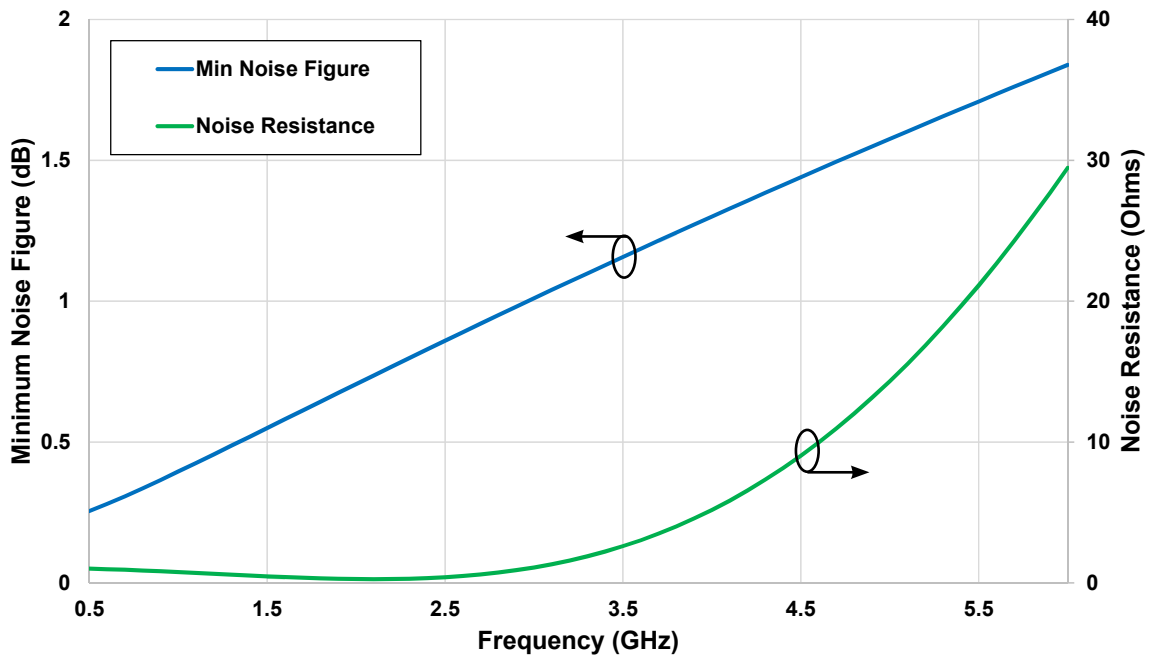

Figure 6. - Simulated Minimum Noise Figure and Noise Resistance vs Frequency of the CG2H40045
 $V_{DD} = 28\text{ V}, I_{DQ} = 400\text{ mA}$



Electrostatic Discharge (ESD) Classifications

Parameter	Symbol	Class	Test Methodology
Human Body Model	HBM	1A > 250 V	JEDEC JESD22 A114-D
Charge Device Model	CDM	1 < 200 V	JEDEC JESD22 C101-C

Simulated Source and Load Impedances

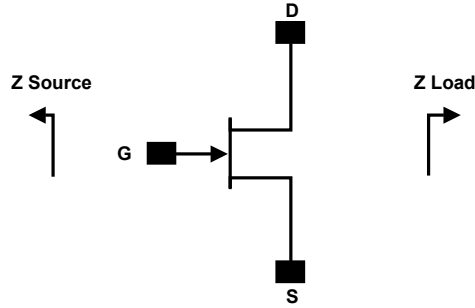

Frequency (MHz)	Z Source	Z Load
500	4.1 + j5.27	14.73 + j6.91
750	2.9 + j 4.1	12.3 + j 7.6
1000	2.7 + j0.8	9.2 + j1.3
1100	1.9 + j 3.1	9.2 + j6.2
1500	2.1 - j 2.5	6.0 + j4.3
1700	2.2 - j2.0	6.5 + j2.3
1800	2.4 - j1.4	7.8 + j1.7
1900	2.8 - j1.8	6.5 + j0.6
2000	2.8 - j1.8	6.5 + j0.6
2100	2.5 - j2.7	5.4 + j0.2
3000	1.4 - j7.3	4.6 - j2.0
4000	2.4 - j11	4.4 - j3.5

Note 1. $V_{DD} = 28V$, $I_{DQ} = 800mA$ in the 440193 package.

Note 2. Optimized for power gain, P_{SAT} and PAE.

Note 3. When using this device at low frequency, series resistors should be used to maintain amplifier stability.

CG2H40045 Power Dissipation De-rating Curve

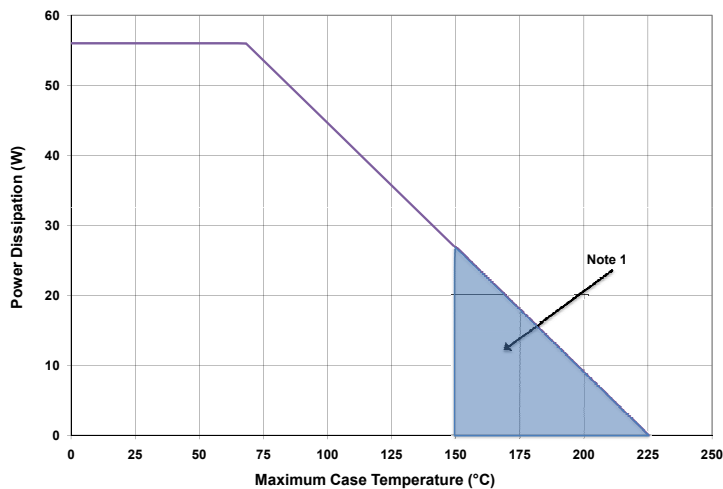

Note 1. Area exceeds Maximum Case Operating Temperature (See Page 2).

CG2H40045-AMP Demonstration Amplifier Circuit Schematic

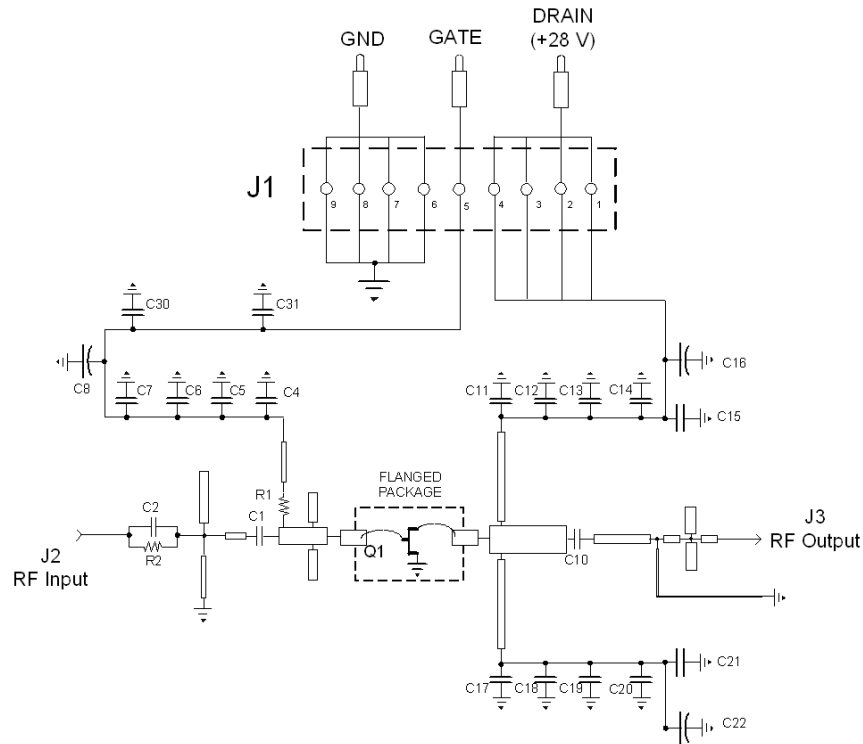

CG2H40045-AMP Demonstration Amplifier Circuit Outline

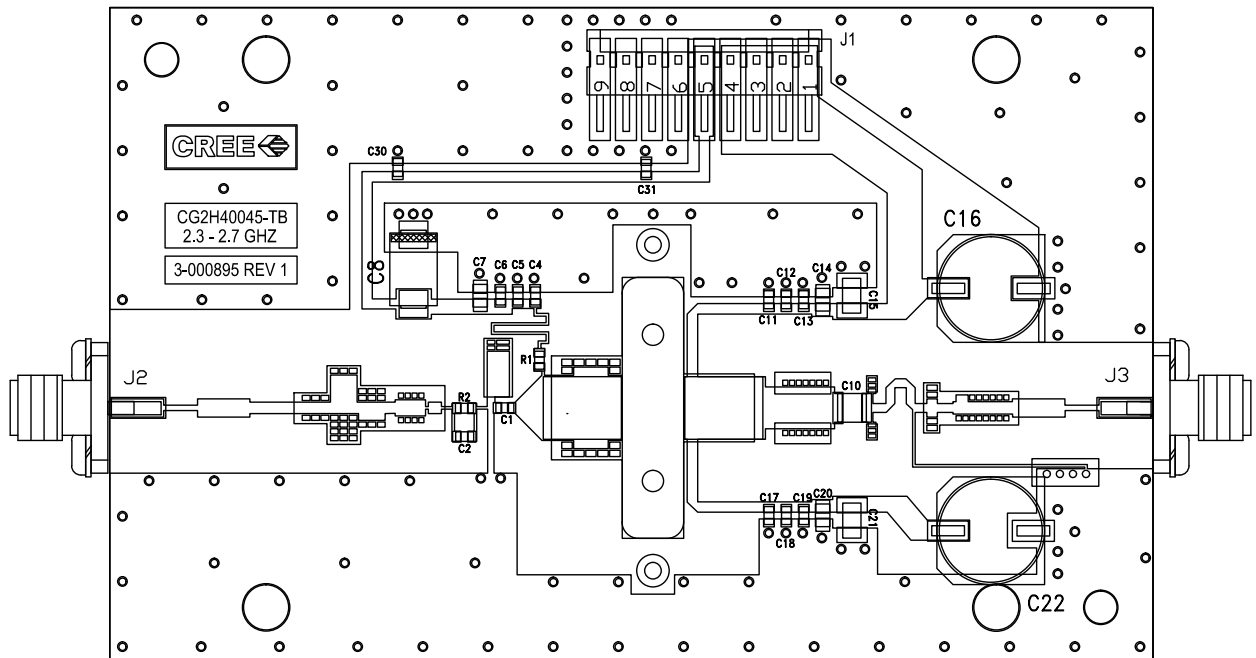

Note: The device slot is machined to different depths to support either pill or flanged versions

CG2H40045-AMP Demonstration Amplifier Circuit Bill of Materials

Designator	Description	Qty
C1	CAP, 0.8pF, ± 0.1 pF, 0603	1
C2	CAP, 2.2pF, ± 0.1 pF, 0603	1
C4,C11,C17	CAP, 10.0pF, +/-5%, 0603, ATC	3
C6,C13, C19	CAP, 470pF ± 5 %, 100 V, 0603, X7R	3
C7,C14,C20	CAP,33000PF, 0805,100V, X7R	3
C8	CAP, 10UF, 16V, SMT, TANTALUM	1
C10	CAP, 8.2pF ± 5 %, ATC100B	1
C15,C21	CAP, 1.0UF ± 10 %, 100V, 1210, X7R	2
C5,C12,C18,C30,C31	CAP, 82.0pF, ± 5 %, 0603	5
C16,C22	CAP, 33UF, 20%, G CASE	2
R2	RES, 1/16W, 0603, 100 Ohms 1%	1
R1	RES, 1/16W, 0603, 5.1 Ohms 1%	1
J2,J3	CONN, SMA, PANEL MOUNT JACK, FLANGE	2
J1	CONN, HEADER, RT>PLZ .1CEN LK 9POS	1
-	PCB, RO4350B, Er = 3.48, h = 20 mil	1
Q1	CG2H40045	1

CG2H40045-AMP Demonstration Amplifier Circuit

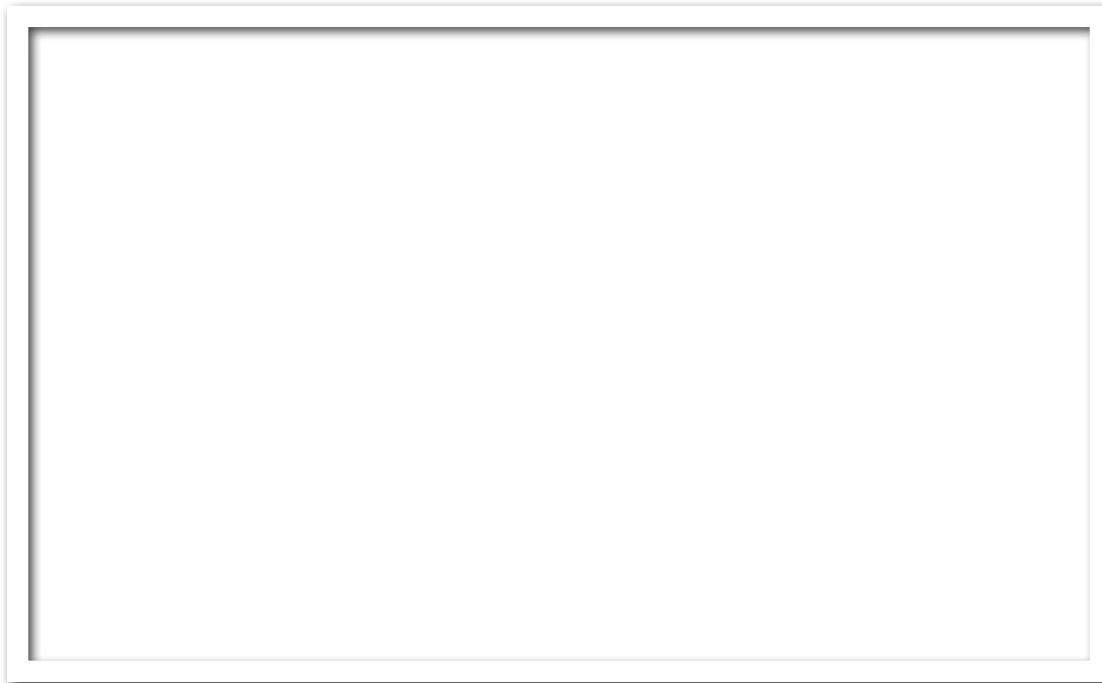

Typical Package S-Parameters for CG2H40045
 (Small Signal, $V_{DS} = 28\text{ V}$, $I_{DQ} = 400\text{ mA}$, angle in degrees)

Frequency	Mag S11	Ang S11	Mag S21	Ang S21	Mag S12	Ang S12	Mag S22	Ang S22
0.500	0.924	-171.10	9.020	83.83	0.012	-0.74	0.733	-175.20
0.600	0.924	-173.39	7.526	80.67	0.012	-2.80	0.736	-176.01
0.700	0.924	-175.16	6.456	77.77	0.012	-4.58	0.738	-176.61
0.800	0.924	-176.61	5.653	75.04	0.012	-6.20	0.740	-177.08
0.900	0.925	-177.85	5.027	72.44	0.012	-7.68	0.743	-177.48
1.000	0.925	-178.94	4.527	69.92	0.012	-9.06	0.745	-177.83
1.100	0.925	-179.93	4.118	67.47	0.012	-10.36	0.748	-178.15
1.200	0.925	179.15	3.779	65.08	0.012	-11.59	0.750	-178.46
1.300	0.926	178.29	3.492	62.74	0.012	-12.76	0.753	-178.76
1.400	0.926	177.47	3.247	60.45	0.012	-13.87	0.756	-179.06
1.500	0.926	176.68	3.035	58.19	0.012	-14.93	0.758	-179.37
1.600	0.927	175.91	2.851	55.97	0.012	-15.93	0.761	-179.69
1.700	0.927	175.15	2.690	53.78	0.012	-16.89	0.764	179.98
1.800	0.927	174.41	2.548	51.62	0.012	-17.79	0.767	179.64
1.900	0.928	173.66	2.423	49.49	0.011	-18.65	0.769	179.28
2.000	0.928	172.92	2.311	47.38	0.011	-19.46	0.772	178.91
2.100	0.928	172.18	2.211	45.30	0.011	-20.23	0.774	178.53
2.200	0.928	171.43	2.121	43.24	0.011	-20.95	0.777	178.12
2.300	0.928	170.67	2.041	41.20	0.011	-21.63	0.779	177.70
2.400	0.928	169.90	1.969	39.17	0.011	-22.27	0.781	177.27
2.500	0.928	169.12	1.905	37.17	0.011	-22.87	0.783	176.81
2.600	0.928	168.32	1.847	35.17	0.011	-23.43	0.785	176.34
2.700	0.928	167.51	1.795	33.19	0.011	-23.95	0.787	175.85
2.800	0.927	166.67	1.748	31.22	0.011	-24.44	0.788	175.34
2.900	0.927	165.82	1.707	29.25	0.011	-24.90	0.790	174.82
3.000	0.926	164.94	1.670	27.29	0.011	-25.32	0.791	174.27
3.200	0.925	163.09	1.609	23.37	0.011	-26.10	0.793	173.13
3.400	0.923	161.12	1.564	19.43	0.011	-26.81	0.794	171.90
3.600	0.921	158.99	1.533	15.44	0.011	-27.47	0.794	170.59
3.800	0.918	156.67	1.515	11.38	0.011	-28.13	0.793	169.19
4.000	0.914	154.13	1.510	7.20	0.011	-28.86	0.791	167.68
4.200	0.910	151.31	1.519	2.88	0.012	-29.69	0.787	166.06
4.400	0.904	148.17	1.541	-1.65	0.012	-30.72	0.783	164.31
4.600	0.897	144.63	1.577	-6.44	0.013	-32.03	0.777	162.41
4.800	0.888	140.59	1.630	-11.56	0.013	-33.71	0.769	160.34
5.000	0.877	135.92	1.701	-17.09	0.014	-35.87	0.759	158.07
5.200	0.864	130.47	1.791	-23.15	0.016	-38.66	0.747	155.55
5.400	0.848	124.02	1.905	-29.86	0.017	-42.23	0.732	152.73
5.600	0.828	116.27	2.045	-37.39	0.019	-46.76	0.715	149.54
5.800	0.804	106.83	2.212	-45.93	0.021	-52.46	0.693	145.87
6.000	0.775	95.17	2.407	-55.72	0.023	-59.58	0.668	141.58

Typical Package S-Parameters for CG2H40045
 (Small Signal, $V_{DS} = 28\text{ V}$, $I_{DQ} = 800\text{ mA}$, angle in degrees)

Frequency	Mag S11	Ang S11	Mag S21	Ang S21	Mag S12	Ang S12	Mag S22	Ang S22
0.500	0.939	-172.50	8.967	84.35	0.010	1.41	0.762	-177.28
0.600	0.939	-174.64	7.489	81.47	0.010	-0.03	0.763	-178.00
0.700	0.939	-176.32	6.432	78.83	0.010	-1.23	0.764	-178.57
0.800	0.939	-177.71	5.639	76.33	0.010	-2.28	0.765	-179.05
0.900	0.939	-178.91	5.024	73.94	0.010	-3.21	0.767	-179.47
1.000	0.939	-179.98	4.532	71.62	0.010	-4.05	0.768	-179.85
1.100	0.939	179.05	4.131	69.36	0.010	-4.82	0.769	179.79
1.200	0.939	178.15	3.798	67.15	0.010	-5.54	0.770	179.44
1.300	0.939	177.29	3.518	64.97	0.009	-6.20	0.771	179.10
1.400	0.939	176.47	3.279	62.82	0.009	-6.81	0.773	178.77
1.500	0.939	175.67	3.073	60.70	0.009	-7.38	0.774	178.43
1.600	0.939	174.90	2.894	58.61	0.009	-7.90	0.775	178.09
1.700	0.938	174.13	2.737	56.54	0.009	-8.39	0.777	177.74
1.800	0.938	173.38	2.600	54.49	0.009	-8.83	0.778	177.38
1.900	0.938	172.63	2.478	52.45	0.009	-9.24	0.779	177.01
2.000	0.938	171.87	2.370	50.43	0.009	-9.61	0.780	176.64
2.100	0.938	171.12	2.274	48.42	0.009	-9.95	0.781	176.25
2.200	0.937	170.36	2.188	46.43	0.009	-10.25	0.782	175.85
2.300	0.937	169.59	2.111	44.44	0.009	-10.53	0.783	175.43
2.400	0.937	168.80	2.043	42.47	0.009	-10.77	0.784	175.00
2.500	0.936	168.01	1.981	40.50	0.009	-10.98	0.785	174.56
2.600	0.936	167.20	1.926	38.53	0.009	-11.17	0.785	174.10
2.700	0.935	166.37	1.877	36.57	0.009	-11.34	0.786	173.63
2.800	0.934	165.52	1.833	34.61	0.009	-11.49	0.786	173.14
2.900	0.934	164.65	1.795	32.65	0.009	-11.62	0.786	172.63
3.000	0.933	163.75	1.761	30.69	0.010	-11.74	0.786	172.11
3.200	0.931	161.87	1.705	26.74	0.010	-11.97	0.786	171.00
3.400	0.928	159.85	1.665	22.74	0.010	-12.20	0.784	169.82
3.600	0.925	157.66	1.640	18.67	0.010	-12.49	0.782	168.56
3.800	0.921	155.28	1.628	14.50	0.011	-12.89	0.779	167.20
4.000	0.917	152.67	1.630	10.19	0.011	-13.46	0.775	165.75
4.200	0.912	149.77	1.645	5.71	0.012	-14.26	0.770	164.17
4.400	0.905	146.53	1.675	1.00	0.012	-15.37	0.763	162.48
4.600	0.897	142.86	1.721	-4.00	0.013	-16.87	0.754	160.63
4.800	0.887	138.67	1.784	-9.36	0.014	-18.85	0.744	158.62
5.000	0.875	133.82	1.865	-15.16	0.015	-21.43	0.731	156.41
5.200	0.860	128.15	1.969	-21.52	0.017	-24.72	0.717	153.98
5.400	0.842	121.43	2.096	-28.57	0.019	-28.86	0.699	151.27
5.600	0.820	113.34	2.250	-36.47	0.021	-34.03	0.678	148.22
5.800	0.794	103.490	2.432	-45.404	0.023	-40.418	0.654	144.730
6	0.76376	91.356	2.6393	-55.605	0.025877	-48.247	0.6254	140.65

Product Dimensions CG2H40045F (Package Type – 440223)

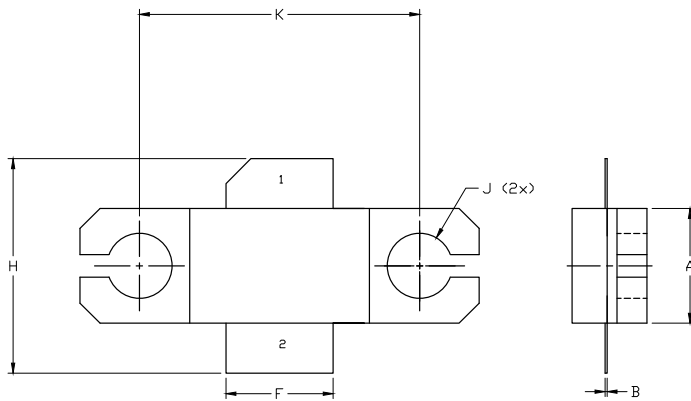

- NOTES:
1. DIMENSIONING AND TOLERANCING PER ANSI Y14.5M, 1982.
 2. CONTROLLING DIMENSION: INCH.
 3. ADHESIVE FROM LID MAY EXTEND A MAXIMUM OF 0.020" BEYOND EDGE OF LID.
 4. LID MAY BE MISALIGNED TO THE BODY OF THE PACKAGE BY A MAXIMUM OF 0.008" IN ANY DIRECTION.
 5. ALL PLATED SURFACES ARE Ni/AU

DIM	INCHES		MILLIMETERS	
	MIN	MAX	MIN	MAX
A	0.225	0.235	5.72	5.97
B	0.004	0.006	0.10	0.15
C	0.145	0.165	3.68	4.19
D	0.077	0.087	1.96	2.21
E	0.355	0.365	9.02	9.27
F	0.210	0.220	5.33	5.59
G	0.795	0.805	20.19	20.45
H	0.400	0.460	10.16	11.68
J	∅ .130		3.30	
k		0.562		14.27

- PIN 1. GATE
 PIN 2. DRAIN
 PIN 3. SOURCE

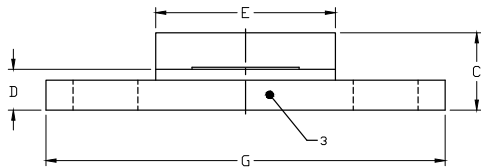

Product Dimensions CG2H40045P (Package Type – 440206)

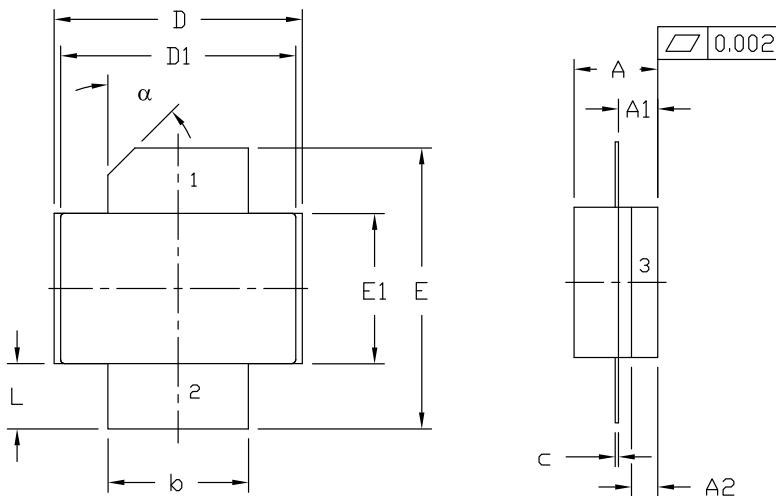





- NOTES:
1. DIMENSIONING AND TOLERANCING PER ANSI Y14.5M - 1994.
 2. CONTROLLING DIMENSION: INCH.
 3. ADHESIVE FROM LID MAY EXTEND A MAXIMUM OF 0.020" BEYOND EDGE OF LID.
 4. LID MAY BE MISALIGNED TO THE BODY OF PACKAGE BY A MAXIMUM OF 0.008" IN ANY DIRECTION.

DIM	INCHES		MILLIMETERS		NOTES
	MIN	MAX	MIN	MAX	
A	0.125	0.145	3.18	3.68	
A1	0.057	0.067	1.45	1.70	
A2	0.035	0.045	0.89	1.14	
b	0.210	0.220	5.33	5.59	2x
c	0.004	0.006	0.10	0.15	2x
D	0.375	0.385	9.53	9.78	
D1	0.355	0.365	9.02	9.27	
E	0.400	0.460	10.16	11.68	
E1	0.225	0.235	5.72	5.97	
L	0.085	0.115	2.16	2.92	2x
α	45°	REF	45°	REF	

- PIN 1. GATE
 PIN 2. DRAIN
 PIN 3. SOURCE

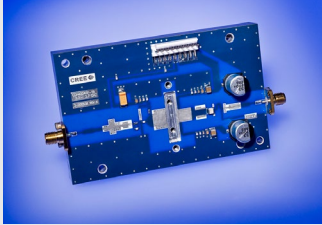
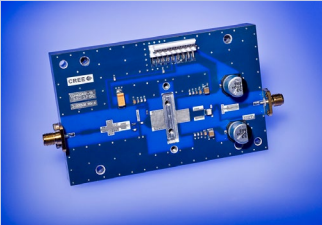
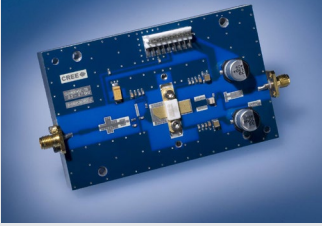
Product Ordering Information

Order Number	Description	Unit of Measure	Image
CG2H40045F	GaN HEMT	Each	
CG2H40045P	GaN HEMT	Each	
CG2H40045F-TB	Test board without GaN HEMT	Each	
CG2H40045P-TB	Test board without GaN HEMT	Each	
CG2H40045F-AMP	Test board with GaN HEMT installed	Each	
CG2H40045P-AMP	Test board with GaN HEMT installed	Each	



Disclaimer

Specifications are subject to change without notice. Cree, Inc. believes the information contained within this data sheet to be accurate and reliable. However, no responsibility is assumed by Cree for any infringement of patents or other rights of third parties which may result from its use. No license is granted by implication or otherwise under any patent or patent rights of Cree. Cree makes no warranty, representation or guarantee regarding the suitability of its products for any particular purpose. "Typical" parameters are the average values expected by Cree in large quantities and are provided for information purposes only. These values can and do vary in different applications and actual performance can vary over time. All operating parameters should be validated by customer's technical experts for each application. Cree products are not designed, intended or authorized for use as components in applications intended for surgical implant into the body or to support or sustain life, in applications in which the failure of the Cree product could result in personal injury or death or in applications for planning, construction, maintenance or direct operation of a nuclear facility.

For more information, please contact:

Cree, Inc.
4600 Silicon Drive
Durham, North Carolina, USA 27703
www.cree.com/RF

Sarah Miller
Marketing & Export
Cree, RF Components
1.919.407.5302

Ryan Baker
Marketing
Cree, RF Components
1.919.407.7816

Tom Dekker
Sales Director
Cree, RF Components
1.919.407.5639



Стандарт Электрон Связь

Мы молодая и активно развивающаяся компания в области поставок электронных компонентов. Мы поставляем электронные компоненты отечественного и импортного производства напрямую от производителей и с крупнейших складов мира.

Благодаря сотрудничеству с мировыми поставщиками мы осуществляем комплексные и плановые поставки широчайшего спектра электронных компонентов.

Собственная эффективная логистика и склад в обеспечивает надежную поставку продукции в точно указанные сроки по всей России.

Мы осуществляем техническую поддержку нашим клиентам и предпродажную проверку качества продукции. На все поставляемые продукты мы предоставляем гарантию .

Осуществляем поставки продукции под контролем ВП МО РФ на предприятия военно-промышленного комплекса России , а также работаем в рамках 275 ФЗ с открытием отдельных счетов в уполномоченном банке. Система менеджмента качества компании соответствует требованиям ГОСТ ISO 9001.

Минимальные сроки поставки, гибкие цены, неограниченный ассортимент и индивидуальный подход к клиентам являются основой для выстраивания долгосрочного и эффективного сотрудничества с предприятиями радиоэлектронной промышленности, предприятиями ВПК и научно-исследовательскими институтами России.

С нами вы становитесь еще успешнее!

Наши контакты:

Телефон: +7 812 627 14 35

Электронная почта: sales@st-electron.ru

Адрес: 198099, Санкт-Петербург,
Промышленная ул, дом № 19, литера Н,
помещение 100-Н Офис 331