



SANYO Semiconductors

DATA SHEET

An ON Semiconductor Company

2SC5245A — NPN Epitaxial Planar Silicon Transistor UHF to S-Band Low-Noise Amplifier OSC Applications

Features

- Low-noise : NF=0.9dB typ (f=1GHz)
: NF=1.4dB typ (f=1.5GHz)
- High gain : $|S_{21e}|^2=10\text{dB typ (f=1.5GHz)}$
- High cut-off frequency : $f_T=8\text{GHz typ}$
- Low-voltage, low-current operation (VCE=1V, IC=1mA)
: $f_T=3.5\text{GHz typ}$
: $|S_{21e}|^2=5.5\text{dB typ (f=1.5GHz)}$

Specifications

Absolute Maximum Ratings at Ta=25°C

Parameter	Symbol	Conditions	Ratings	Unit
Collector-to-Base Voltage	V _{CBO}		20	V
Collector-to-Emitter Voltage	V _{CEO}		10	V
Emitter-to-Base Voltage	V _{EBO}		1.5	V
Collector Current	I _C		30	mA
Collector Dissipation	P _C		150	mW
Junction Temperature	T _j		150	°C
Storage Temperature	T _{stg}		-55 to +150	°C

Package Dimensions

unit : mm (typ)

7023A-009

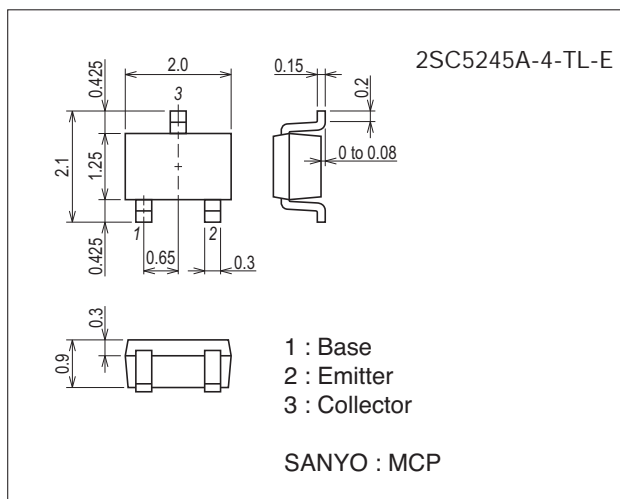

Product & Package Information

- Package : MCP
- JEITA, JEDEC : SC-70, SOT-323
- Minimum Packing Quantity : 3,000 pcs./reel

Packing Type: TL

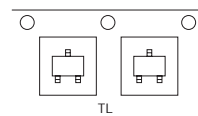

Marking

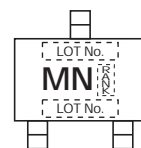

Electrical Connection

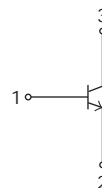

2SC5245A

Electrical Characteristics at Ta=25°C

Parameter	Symbol	Conditions	Ratings			Unit
			min	typ	max	
Collector Cutoff Current	ICBO	V _{CB} =10V, I _E =0A			1.0	μA
Emitter Cutoff Current	IEBO	V _{EB} =1V, I _C =0A			10	μA
DC Current Gain	h _{FE}	V _{CE} =5V, I _C =10mA	60*		270*	
Gain-Bandwidth Product	f _{T1}	V _{CE} =5V, I _C =10mA	5	8		GHz
	f _{T2}	V _{CE} =1V, I _C =1mA		3.5		GHz
Output Capacitance	Cob	V _{CB} =10V, f=1MHz		0.45	0.7	pF
Reverse Transfer Capacitance	Cre			0.30		pF
Forward Transfer Gain	S _{21e} ² ₁	V _{CE} =5V, I _C =10mA, f=1.5GHz	8	10		dB
	S _{21e} ² ₂	V _{CE} =1V, I _C =1mA, f=1.5GHz		5.5		dB
Noise Figure	NF1	V _{CE} =5V, I _C =5mA, f=1.5GHz		1.4	3.0	dB
	NF2	V _{CE} =2V, I _C =3mA, f=1GHz		0.9		dB

* : The 2SC5245A is classified by 10mA h_{FE} as follows :

Rank	3	4	5
h _{FE}	60 to 120	90 to 180	135 to 270

Ordering Information

Device	Package	Shipping	memo
2SC5245A-4-TL-E	MCP	3,000pcs./reel	Pb Free

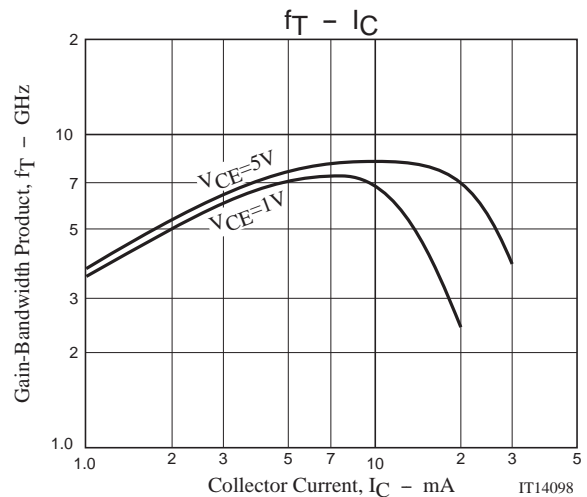
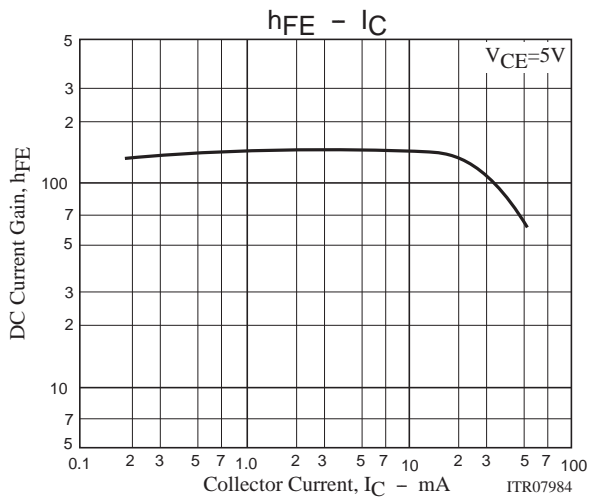

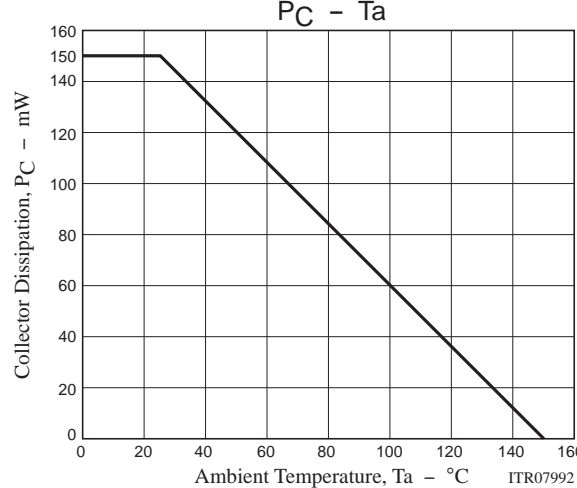
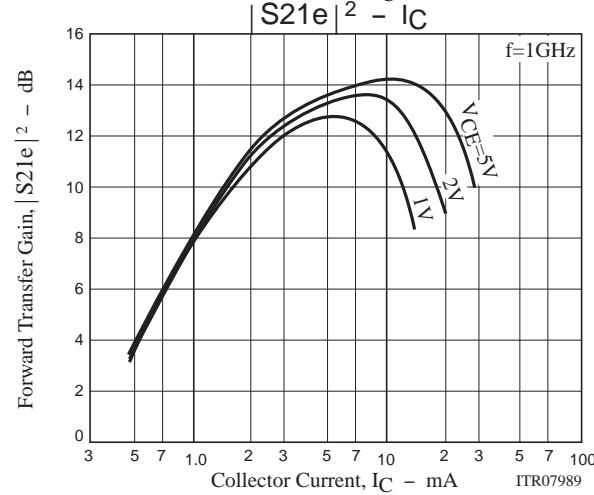
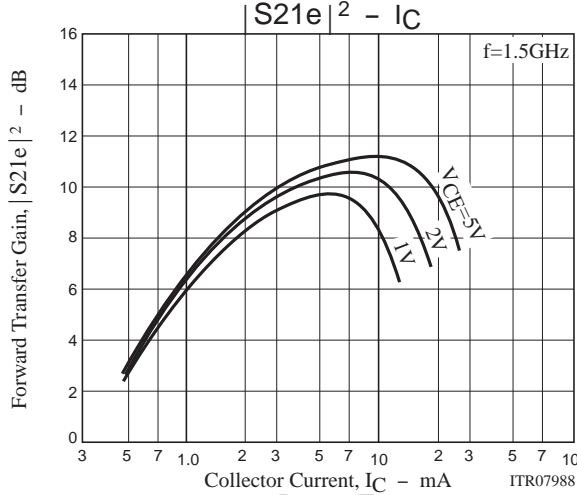
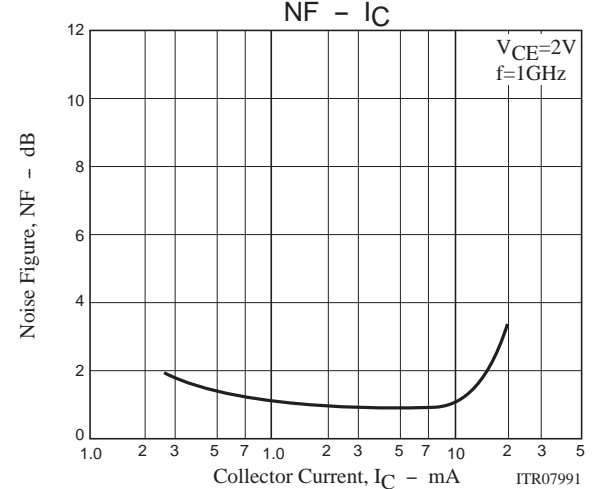
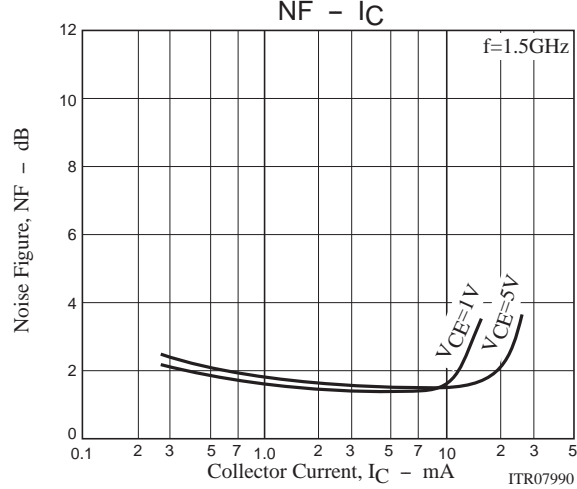
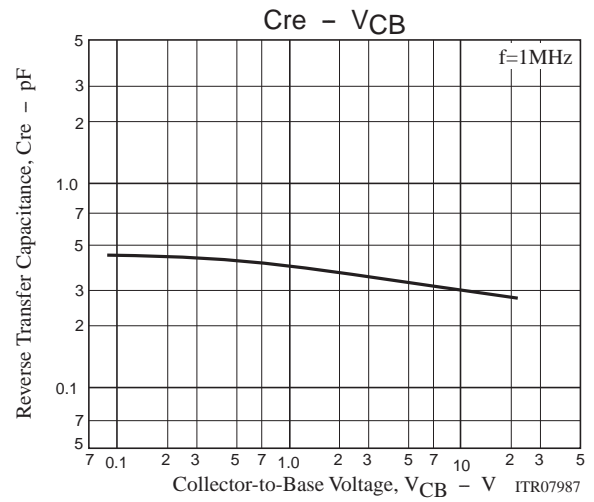
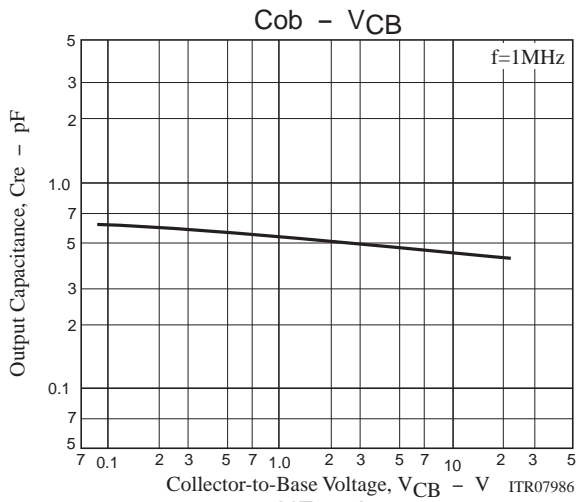

2SC5245A

S11e

f=200MHz to 2000MHz(200MHz Step)

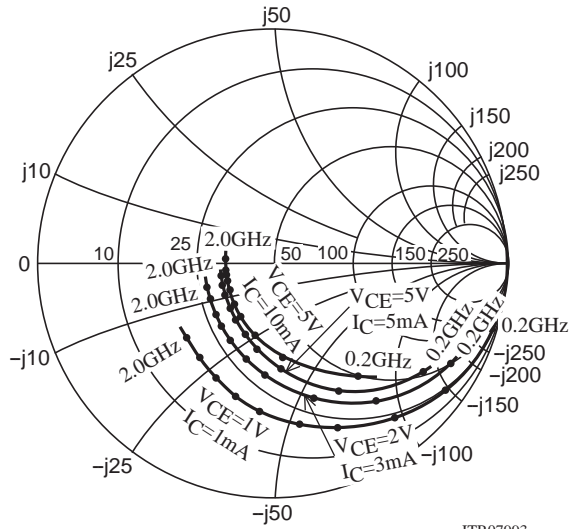

ITR07993

S21e

f=200MHz to 2000MHz(200MHz Step)

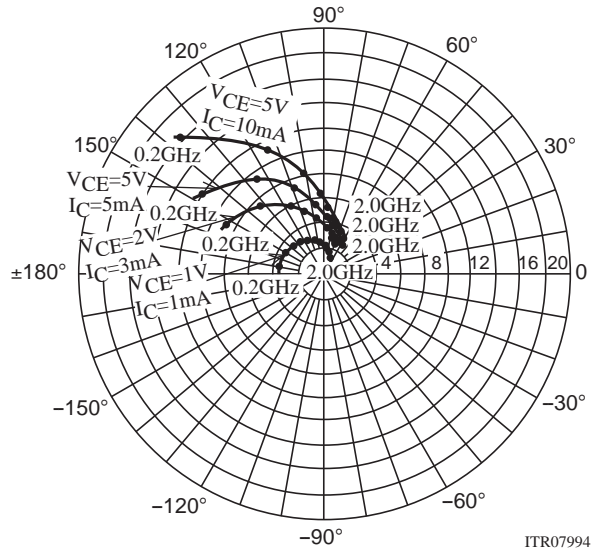

ITR07994

S12e

f=200MHz to 2000MHz(200MHz Step)

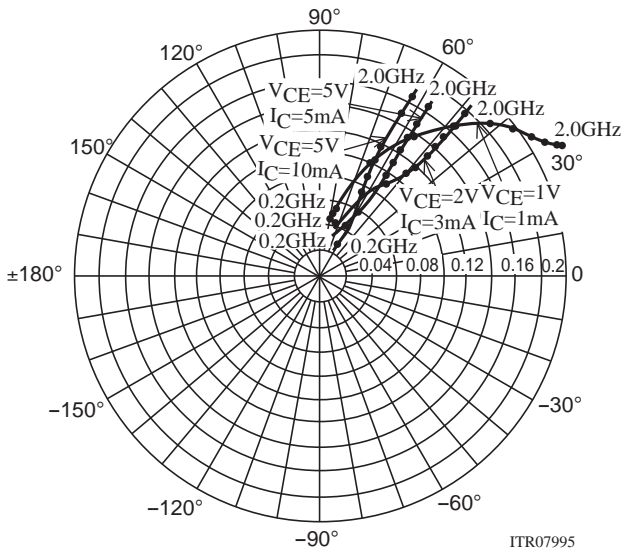

ITR07995

S22e

f=200MHz to 2000MHz(200MHz Step)

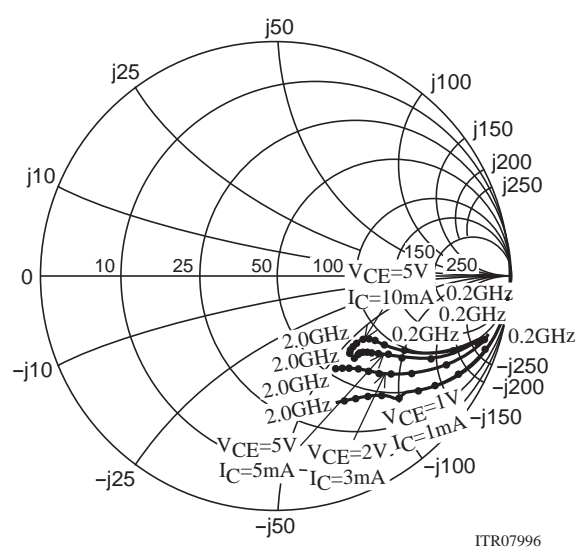

ITR07996

2SC5245A

S Parameters (Common emitter)

$V_{CE}=5V, I_C=5mA, Z_O=50\Omega$

Freq(MHz)	S11	$\angle S11$	S21	$\angle S21$	S12	$\angle S12$	S22	$\angle S22$
200	0.763	-37.5	11.926	146.9	0.036	70.7	0.892	-19.1
400	0.590	-65.4	9.202	124.3	0.058	60.9	0.740	-29.1
600	0.456	-85.5	7.173	109.4	0.073	57.4	0.631	-33.7
800	0.374	-102.0	5.743	98.7	0.086	56.7	0.566	-35.8
1000	0.323	-115.0	4.785	90.5	0.098	56.7	0.528	-37.2
1200	0.288	-127.5	4.105	83.6	0.110	57.2	0.505	-38.4
1400	0.264	-137.7	3.599	77.5	0.123	57.7	0.488	-39.6
1600	0.248	-147.4	3.213	71.3	0.136	57.6	0.476	-41.2
1800	0.239	-156.9	2.905	66.4	0.150	57.6	0.466	-43.3
2000	0.235	-165.7	2.651	61.3	0.165	57.2	0.462	-45.4

$V_{CE}=5V, I_C=10mA, Z_O=50\Omega$

Freq(MHz)	S11	$\angle S11$	S21	$\angle S21$	S12	$\angle S12$	S22	$\angle S22$
200	0.605	-52.6	16.354	136.2	0.031	67.5	0.804	-23.9
400	0.417	-84.6	11.011	113.3	0.048	62.4	0.622	-30.5
600	0.319	-106.3	8.026	100.5	0.062	62.2	0.533	-32.0
800	0.266	-124.6	6.250	91.3	0.076	63.4	0.491	-32.4
1000	0.238	-136.5	5.115	84.7	0.090	64.3	0.469	-33.2
1200	0.225	-148.9	4.336	78.8	0.104	64.4	0.458	-34.6
1400	0.215	-158.3	3.813	73.4	0.119	64.5	0.449	-35.8
1600	0.213	-167.3	3.365	68.1	0.135	63.8	0.443	-37.7
1800	0.212	-175.6	3.030	63.5	0.150	63.1	0.436	-39.6
2000	0.216	-177.5	2.754	58.9	0.166	62.5	0.438	-41.9

$V_{CE}=2V, I_C=3mA, Z_O=50\Omega$

Freq(MHz)	S11	$\angle S11$	S21	$\angle S21$	S12	$\angle S12$	S22	$\angle S22$
200	0.842	-30.7	8.491	153.0	0.044	72.5	0.931	-17.1
400	0.704	-56.3	7.161	131.9	0.075	60.9	0.808	-28.8
600	0.579	-76.1	5.879	116.3	0.095	54.1	0.696	-36.2
800	0.480	-93.1	4.882	104.2	0.109	51.0	0.615	-40.6
1000	0.417	-106.3	4.154	95.0	0.121	49.3	0.564	-43.5
1200	0.376	-119.6	3.597	87.1	0.132	48.7	0.526	-45.8
1400	0.343	-130.2	3.212	80.2	0.143	48.6	0.496	-47.5
1600	0.319	-140.5	2.875	73.4	0.154	48.7	0.475	-49.6
1800	0.303	-150.0	2.604	67.7	0.166	48.6	0.461	-51.6
2000	0.298	-160.0	2.383	62.1	0.179	48.9	0.451	-52.9

$V_{CE}=1V, I_C=1mA, Z_O=50\Omega$

Freq(MHz)	S11	$\angle S11$	S21	$\angle S21$	S12	$\angle S12$	S22	$\angle S22$
200	0.945	-18.9	3.296	162.5	0.054	77.2	0.980	-11.0
400	0.884	-37.3	3.206	145.9	0.102	65.9	0.934	-20.5
600	0.810	-53.6	2.942	131.2	0.139	56.3	0.870	-29.0
800	0.728	-69.4	2.711	117.8	0.166	48.6	0.811	-35.5
1000	0.667	-82.5	2.449	107.0	0.187	42.5	0.763	-40.9
1200	0.605	-95.8	2.252	96.9	0.199	37.3	0.715	-45.7
1400	0.561	-106.1	2.061	88.1	0.207	33.5	0.673	-49.4
1600	0.518	-117.2	1.909	79.5	0.212	30.6	0.638	-53.4
1800	0.492	-127.5	1.766	72.2	0.215	28.6	0.611	-56.5
2000	0.465	-137.9	1.658	65.2	0.217	27.6	0.592	-59.9

2SC5245A

Embossed Taping Specification

2SC5245A-4-TL-E

1. Packing Format

Package Name	Carrier Tape Type	Maximum Number of devices contained (pcs)			Packing format	
		Reel	Inner box	Outer box	Inner BOX (C-1)	Outer BOX (A-7)
MCP	MCP	3,000	15,000	90,000	5 reels contained Dimensions:mm (external) 183×72×185	6 inner boxes contained Dimensions:mm (external) 440×195×210

Packing method

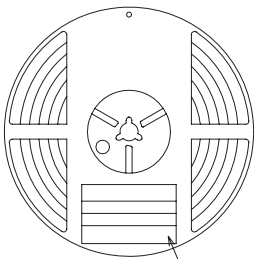

Reel label

Type No.
LOT No.
Quantity
Origin

Reel label, Inner box label
(unit:mm)

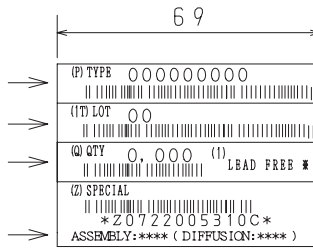

Outer box label

It is a label at the time of factory shipments.
The form of a label may change in physical distribution process.

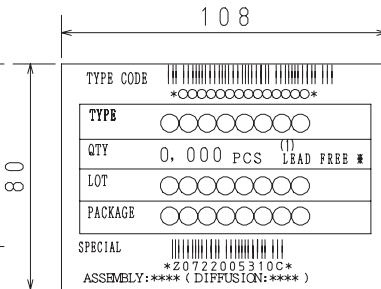

NOTE (1)

The LEAD FREE ⚡ description shows that the surface treatment of the terminal is lead free.

Label	JEITA Phase
LEAD FREE 3	JEITA Phase 3A
LEAD FREE 4	JEITA Phase 3

2. Taping configuration

2-1. Carrier tape size (unit:mm)

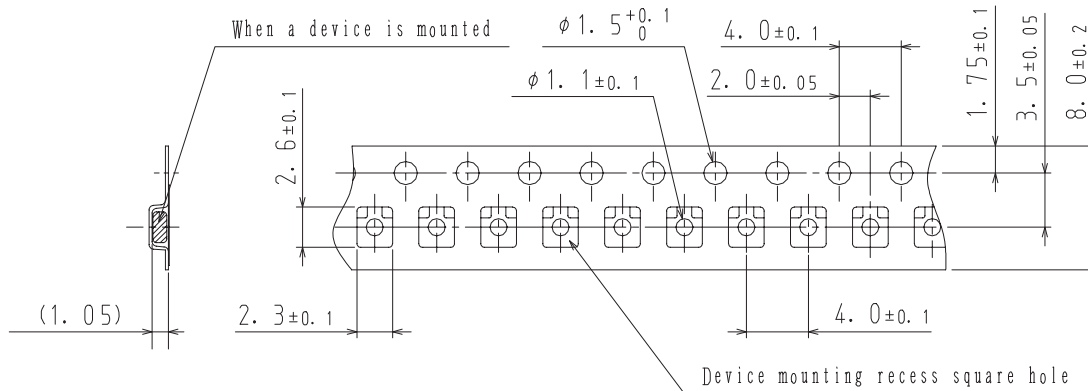

2-2. Device placement direction

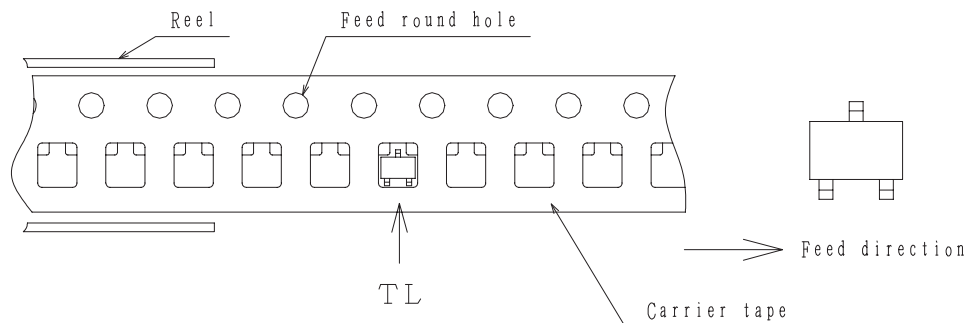

Those with oen electrode terminal on the feed hole side.....TL

2SC5245A

Outline Drawing 2SC5245A-4-TL-E

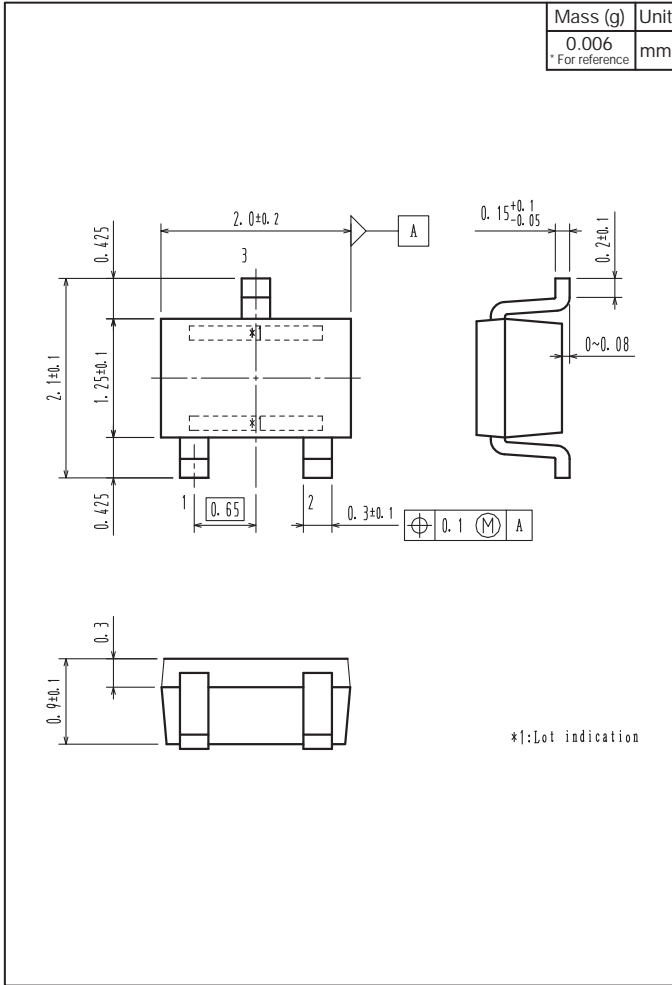

Land Pattern Example

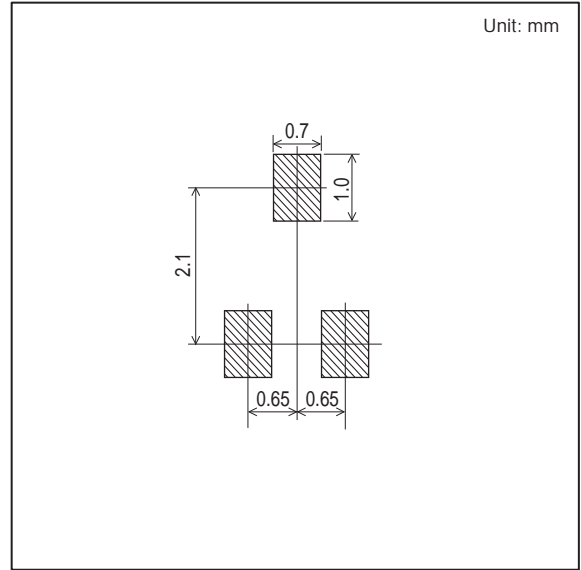

- Any and all SANYO Semiconductor Co.,Ltd. products described or contained herein are, with regard to "standard application", intended for the use as general electronics equipment. The products mentioned herein shall not be intended for use for any "special application" (medical equipment whose purpose is to sustain life, aerospace instrument, nuclear control device, burning appliances, transportation machine, traffic signal system, safety equipment etc.) that shall require extremely high level of reliability and can directly threaten human lives in case of failure or malfunction of the product or may cause harm to human bodies, nor shall they grant any guarantee thereof. If you should intend to use our products for new introduction or other application different from current conditions on the usage of automotive device, communication device, office equipment, industrial equipment etc. , please consult with us about usage condition (temperature, operation time etc.) prior to the intended use. If there is no consultation or inquiry before the intended use, our customer shall be solely responsible for the use.
- Specifications of any and all SANYO Semiconductor Co.,Ltd. products described or contained herein stipulate the performance, characteristics, and functions of the described products in the independent state, and are not guarantees of the performance, characteristics, and functions of the described products as mounted in the customer's products or equipment. To verify symptoms and states that cannot be evaluated in an independent device, the customer should always evaluate and test devices mounted in the customer's products or equipment.
- SANYO Semiconductor Co.,Ltd. assumes no responsibility for equipment failures that result from using products at values that exceed, even momentarily, rated values (such as maximum ratings, operating condition ranges, or other parameters) listed in products specifications of any and all SANYO Semiconductor Co.,Ltd. products described or contained herein.
- Regarding monolithic semiconductors, if you should intend to use this IC continuously under high temperature, high current, high voltage, or drastic temperature change, even if it is used within the range of absolute maximum ratings or operating conditions, there is a possibility of decrease reliability. Please contact us for a confirmation.
- SANYO Semiconductor Co.,Ltd. strives to supply high-quality high-reliability products, however, any and all semiconductor products fail or malfunction with some probability. It is possible that these probabilistic failures or malfunction could give rise to accidents or events that could endanger human lives, trouble that could give rise to smoke or fire, or accidents that could cause damage to other property. When designing equipment, adopt safety measures so that these kinds of accidents or events cannot occur. Such measures include but are not limited to protective circuits and error prevention circuits for safe design, redundant design, and structural design.
- In the event that any or all SANYO Semiconductor Co.,Ltd. products described or contained herein are controlled under any of applicable local export control laws and regulations, such products may require the export license from the authorities concerned in accordance with the above law.
- No part of this publication may be reproduced or transmitted in any form or by any means, electronic or mechanical, including photocopying and recording, or any information storage or retrieval system, or otherwise, without the prior written consent of SANYO Semiconductor Co.,Ltd.
- Any and all information described or contained herein are subject to change without notice due to product/technology improvement, etc. When designing equipment, refer to the "Delivery Specification" for the SANYO Semiconductor Co.,Ltd. product that you intend to use.
- Upon using the technical information or products described herein, neither warranty nor license shall be granted with regard to intellectual property rights or any other rights of SANYO Semiconductor Co.,Ltd. or any third party. SANYO Semiconductor Co.,Ltd. shall not be liable for any claim or suits with regard to a third party's intellectual property rights which has resulted from the use of the technical information and products mentioned above.

This catalog provides information as of July, 2012. Specifications and information herein are subject to change without notice.



Стандарт Электрон Связь

Мы молодая и активно развивающаяся компания в области поставок электронных компонентов. Мы поставляем электронные компоненты отечественного и импортного производства напрямую от производителей и с крупнейших складов мира.

Благодаря сотрудничеству с мировыми поставщиками мы осуществляем комплексные и плановые поставки широчайшего спектра электронных компонентов.

Собственная эффективная логистика и склад в обеспечивает надежную поставку продукции в точно указанные сроки по всей России.

Мы осуществляем техническую поддержку нашим клиентам и предпродажную проверку качества продукции. На все поставляемые продукты мы предоставляем гарантию .

Осуществляем поставки продукции под контролем ВП МО РФ на предприятия военно-промышленного комплекса России , а также работаем в рамках 275 ФЗ с открытием отдельных счетов в уполномоченном банке. Система менеджмента качества компании соответствует требованиям ГОСТ ISO 9001.

Минимальные сроки поставки, гибкие цены, неограниченный ассортимент и индивидуальный подход к клиентам являются основой для выстраивания долгосрочного и эффективного сотрудничества с предприятиями радиоэлектронной промышленности, предприятиями ВПК и научно-исследовательскими институтами России.

С нами вы становитесь еще успешнее!

Наши контакты:

Телефон: +7 812 627 14 35

Электронная почта: sales@st-electron.ru

Адрес: 198099, Санкт-Петербург,
Промышленная ул, дом № 19, литера Н,
помещение 100-Н Офис 331