

Popular
Variable Transformers
and AC Power Supplies

STACO ENERGY[®]

PRODUCTS CO.

Product Guide— AC Voltage Control Devices



Staco Energy Products Co. has been a leading manufacturer of variable transformers for over 65 years, building standard and custom-designed products for industrial, commercial and military applications. Variable transformers have many industrial and laboratory applications as basic components to control voltage, current, power, heat, speed, light and electromechanical force.

A basic Staco variable transformer consists of a single layer magnet wire winding on a toroidal core of laminated silicon steel. A carbon brush, connected to an output lead, is rotated over a precision ground, plated commutator track to tap off voltage at any turn from zero to the maximum output voltage of the winding.

Staco research has developed design features and proprietary processes to provide longer lasting, more reliable products. Particularly important is the high-temperature foundation material bonding the coil securely to the core assembly. This material has a high thermal transfer characteristic so that it dissipates heat from the brush contact area, increases the heat distribution of the core itself, and provides the transformer with greater tolerance to transients and short-term overloads.

In addition to the basic styles illustrated, Staco Energy can meet your specific requirements with hundreds of additional standard model variations and configurations from 0.8 to 450 amps, 120 to 575 volts, 50 Hz and up. 480 volt units are shown on page 8 and in our Variable Transformer Voltage Control Catalog (VT-5). These models include cased and uncased, single and three phase manual and motor driven models, and complete voltage control systems. Complete information is contained in our Variable Transformer Voltage Control Catalog.

To serve your needs promptly, Staco Energy has a national network of stocking distributors to assure immediate off-the-shelf delivery. Your local Staco distributors and representatives are factory trained, and capable of assisting you in selecting the particular Staco transformer best suited for your application.

Contact our factory or visit the "Where to Buy" section of www.StacoEnergy.com for the name of the distributors or sales representative in your area.

For nonstandard products (to meet your special application needs) our engineering staff will quickly respond with custom solutions to your application requirements. Often a simple revision to a standard component is all that is required, allowing us to keep your costs at a minimum.



Some Models Are Listed by the Canadian Standards Association File No. LR18948

Dimensions are provided throughout this catalog in inches [millimeters].

Panel Mount, Single Phase — 120 and 240 Volt Adjustable Shaft

100 and 200 Series

Type	A
171, 201	1.88" (47.6)
221-B, 252	2.12" (54.0)
291	2.31" (58.7)

Part No.	Input		Output				Net Wt. Lbs.	
	Volts	Hertz	Volts	Constant Current Load		Constant Impedance Load		
				Max. Amps.	Max. kVA	Max. Amps.		Max. kVA
171	120	50/60	0-120	1.75	0.21	2.2	0.26	2
		60	0-132	1.75	0.23	—	—	
201	120	50/60	0-120	2.0	0.24	2.5	0.30	2
		60	0-132	2.0	0.26	—	—	
221-B	120	50/60	0-120	2.50	0.30	3.2	0.38	2.5
		60	0-132	2.50	0.30	—	—	
291	120	50/60	0-120	3.0	0.36	3.5	0.42	2.5
		60	0-132	3.0	0.40	—	—	
252	240	50/60	0-240	0.8	0.19	1.0	0.24	2.5
		60	0-264	0.8	0.21	—	—	

500 Series

Part No.	Input		Output				Net Wt. Lbs.	
	Volts	Hertz	Volts	Constant Current Load		Constant Impedance Load		
				Max. Amps.	Max. kVA	Max. Amps.		Max. kVA
511	120	50/60	0-120	5.0	0.60	7.0	0.84	4.25
			0-140	5.0	0.70	—	—	

Adjustable Shaft

501C Series

Part No.	Input		Output				Net Wt. Lbs.	
	Volts	Hertz	Volts	Constant Current Load		Constant Impedance Load		
				Max. Amps.	Max. kVA	Max. Amps.		Max. kVA
501C	120	50/60	0-120	5.0	0.60	7.0	0.84	5.25
			0-140	5.0	0.70	—	—	

Adjustable Shaft

1000 and 2200 Series

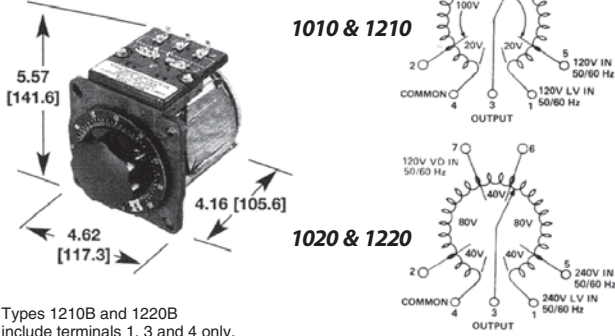

Types 1210B and 1220B include terminals 1, 3 and 4 only.

Part No.	Input		Output				Net Wt. Lbs.	
	Volts	Hertz	Volts	Constant Current Load		Constant Impedance Load		
				Max. Amps.	Max. kVA	Max. Amps.		Max. kVA
1010B	120	50/60	0-120	10.0	1.20	13.0	1.56	10.25
1210B	120	60	0-120	12.0	1.44	15.0	1.80	10.25
			0-240	3.5	0.84	5.0	1.20	
1020B	240	50/60	0-280	3.5	0.98	—	—	10.25
	120	50/60	0-280	3.5*	0.42*	—	—	
1220B	240	60	0-240	5.0	1.20	7.0	1.68	10.25

1500 Series

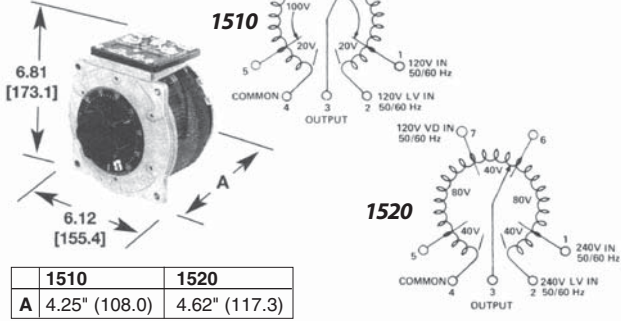

1510	1520
A 4.25" (108.0)	4.62" (117.3)

Part No.	Input		Output				Net Wt. Lbs.	
	Volts	Hertz	Volts	Constant Current Load		Constant Impedance Load		
				Max. Amps.	Max. kVA	Max. Amps.		Max. kVA
1510	120	50/60	0-120	15.0	1.80	20.0	2.40	15.75
			0-140	15.0	2.10	—	—	
1520	240	50/60	0-240	9.5	2.28	12.0	2.88	19.25
			0-280	9.5	2.66	—	—	
	120	50/60	0-280	9.5*	1.14*	—	—	

2500 Series

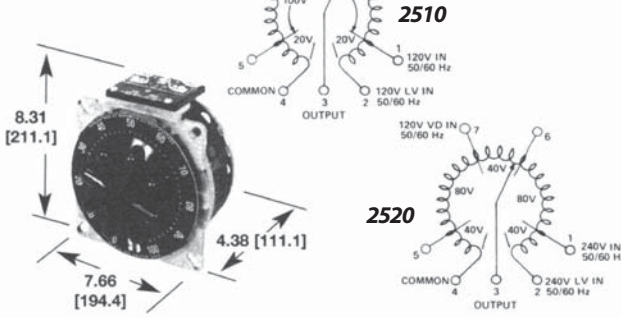

Part No.	Input		Output				Net Wt. Lbs.	
	Volts	Hertz	Volts	Constant Current Load		Constant Impedance Load		
				Max. Amps.	Max. kVA	Max. Amps.		Max. kVA
2510	120	50/60	0-120	25.0	3.00	30.0	3.60	21
			0-140	25.0	3.50	—	—	
			0-240	10.0	2.40	13.0	3.12	
2520	240	50/60	0-280	10.0	2.80	—	—	21
			120	50/60	0-280	10.0*	1.20*	

5000 Series

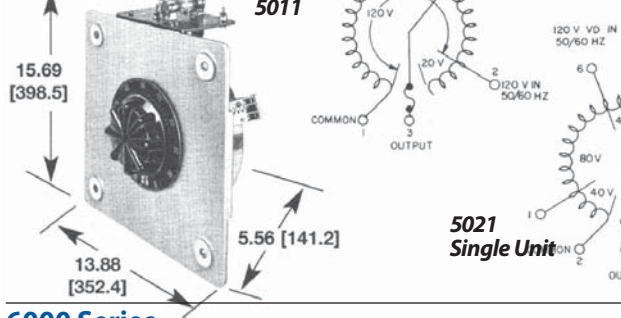

Part No.	Input		Output		Net Wt. Lbs.	
	Volts	Hertz	Volts	Constant Current Load		
				Max. Amps.		Max. kVA
5011	120	50/60	0-140	50.0	7.00	57
5021	240	50/60	0-240	28.0	6.70	57
			0-280	28.0	7.80	
	120	50/60	0-280	28.0*	3.40*	

6000 Series

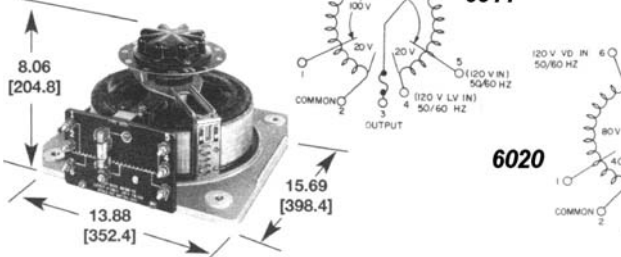

Part No.	Input		Output		Net Wt. Lbs.	
	Volts	Hertz	Volts	Constant Current Load		
				Max. Amps.		Max. kVA
6011	120	50/60	0-120	60.0	7.20	67
			0-140	60.0	8.40	
6020	240	50/60	0-240	35.0	8.40	63
			0-280	35.0	9.80	
	120	50/60	0-280	35.0*	4.20*	

*Voltage Doubler operation, refer to Variable Transformer Voltage/Control Catalog (VT-5).

Data is subject to change without notice.

Enclosed Cord and Plug Series

The cased plug-in models feature a ventilated steel case, input line cord and plug, NEMA rated output receptacle, and an illuminated on/off switch. They are connected for output voltage increase with a clockwise rotation, and the dials are graduated from 0 - 100 percent of the voltage setting. For application flexibility, two field modification kits have been added to the product line. The 3PN-MK kit allows either the 3PN221B or 3PN501B to be wall, bench top, or machine mounted. The 3PN-SK kit provides an adjustable voltage stop for either the 3PN1000, 3PN1200, or 3PN1500 Series.

Plug and Receptacle Styles

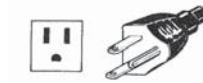

3PN 120 Volt Types

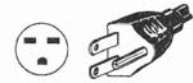

3PN 240 Volt Types



3PN-MK-Kit

Part No.	Input		Output				Height	Width	Depth	Net Wt. Lbs.	
	Volts	Hertz	Volts	Constant Current Load		Constant Impedance Load					
				Max. Amps.	Max. kVA	Max. Amps.					Max. kVA
3PN221B	120	60	0-132	2.50	0.33	—	—	5.31 [134.9]	6.06 [154.0]	4.10 [104.2]	3 7.75
3PN501B		50/60	0-140	5.0*	0.70	—	—				



3PN-SK-Kit

Part No.	Input		Output				Height	Width	Depth	Net Wt. Lbs.	
	Volts	Hertz	Volts	Constant Current Load		Constant Impedance Load					
				Max. Amps.	Max. kVA	Max. Amps.					Max. kVA
3PN1010B	120	50/60	0-140	10.0	1.40	—	—	5.50 [139.7]	4.62 [117.4]	6.96 [176.8]	10.25
3PN1210B	120	60	0-120	12.0	1.44	15.0	1.80	5.50 [139.7]	4.62 [117.4]	6.96 [176.8]	10.25
3PN1020B	240	50/60	0-280	3.5	0.98	—	—	5.50 [139.7]	4.62 [117.4]	6.96 [176.8]	10.25
3PN1220B	240	60	0-240	5.0	1.20	7.0	1.68	5.50 [139.7]	4.62 [117.4]	6.96 [176.8]	10.25



Part No.	Input		Output				Height	Width	Depth	Net Wt. Lbs.	
	Volts	Hertz	Volts	Constant Current Load		Constant Impedance Load					
				Max. Amps.	Max. kVA	Max. Amps.					Max. kVA
3PN1510B	120	50/60	0-140	15.0	2.10	—	—	6.00 [152.4]	6.24 [158.4]	9.35 [237.4]	18
3PN1520B	240	50/60	0-280	9.5	2.66	—	—	6.00 [152.4]	6.24 [158.4]	9.35 [237.4]	22

2200 and 2500 Series



Part No.	Input		Output				H x W x D (cm)	Net Wt. Lbs.	
	Volts	Hertz	Volts	Constant Current Load		Constant Impedance Load			
				Max. Amps.	Max. kVA	Max. Amps.			Max. kVA
3PN2210B	120	50/60	0-140	22.0	3.08	—	—	6.31 x 7.95 x 10.85 (160.3 x 202.1 x 275.6)	24.25
3PN2520B	240	50/60	0-280	10.0	2.80	—	—		

Metered Models

Cased plug-in models of the 1010B, 1020B, 1510 and 1520 series are also available with a pivot and jewel AC voltmeter or ammeter (+/- 5% full scale accuracy) conveniently located atop the enclosure for easy accurate readout. It is ideal for applications where voltage control is

necessary. The 120 volt types have 0-150V voltmeters and the 240 volt types have 0-300V voltmeters. Units with voltmeters have the suffix "V" at the end of their part number. Units with ammeters have the suffix "A."



Part No.	Input		Output		H x W x D (cm)	Net Wt. Lbs.
	Volts	Hertz	Volts	Current		
3PN1010BV	120	50/60	0 - 140	10.0	5.50x 4.62x 6.96 (139.7x117.4x176.8)	10.25
3PN1010BA	120	50/60	0 - 140	10.0	5.50x 4.62x 6.96 (139.7x117.4x176.8)	10.25
3PN1510BV	120	50/60	0 - 140	15.0	6.00x 6.24x 9.35 (152.4x158.4x237.4)	18
3PN1510BA	120	50/60	0 - 140	15.0	6.00x 6.24x 9.35 (152.4x158.4x237.4)	22
3PN1020BV	240	50/60	0 - 280	3.5	5.50x 4.62x 6.96 (139.7x117.4x176.8)	10.25
3PN1020BA	240	50/60	0 - 280	3.5	5.50x 4.62x 6.96 (139.7x117.4x176.8)	10.25
3PN1520BV	240	50/60	0 - 280	95	6.00x 6.24x 9.35 (152.4x158.4x237.4)	22
3PN1520BA	240	50/60	0 - 280	95	6.00x 6.24x 9.35 (152.4x158.4x237.4)	22

Isolated Portable Cord and Plug Models



Part No.	Input		Output		H x W x D (cm)	Net Wt. Lbs.
	Volts	Hertz	Volts	Current		
3PNJ201B	120	50/60	0-140	20	5.50 x 4.62x 6.96 (139.7x117.4x176.8)	9
3PNJ401B	120	50/60	0 - 140	40	6.00 x 6.24x 9.35 (152.4x158.4x237.4)	17

Microprocessor Controller

Advantages:

- Intelligent Microprocessor Based
- Controls variable voltage transformer regulation to within +/-0.5 volts
- Multi-channelled unit enables control of 1, 2 or 3 individual variable transformers or each phase of a 3 phase unit
- LCD display of feedback signals and set points
- Available with standard analog control signals for set point and control functions.
- Available with standard bi-directional RS-232, RS-422, IEEE-488 communication ports for set point and control functions.
- Multiple set points, ramping, and dwells are available.
- User programmable to accept peak-to-peak, rms, or average AC feedback signals
- Heavy duty, wall-mountable NEMA 12 style enclosure.
- Control of the unit can be local, at a remote location, or both.
- Battery back-up RAM retains data if power is lost.
- Microterminal available for remote or stand-alone monitoring and control
- Precise control of voltage ramping through the use of state-of-the-art PWM technology
- Expanded memory allows customization to specific application requirements.
- Field upgradeable -- options can be installed in the field as your needs change.
- Automatic shut-down or alarm with phase loss detection

FRC-20 Controller

Advantages:

- Regulated Output Voltage
- 0-5 VDC or 4-20 mA Set Point Control
- 1 kohm Potentiometer or Fixed Resistor Network Control
- Full or Limited Range Control
- Compact Size
- Easy to Mount
- Up to 600 VAC Feedback Voltage Operation
- Current Regulation



FRC-20 Controller

The MP Controller comes in three basic models:

MPA - Single channel feedback and control

MPB - Two independent channels of feedback and control

MPC - Three independent channels of feedback and control

Available Options:

- Bi-directional RS-232, RS-422, IEEE-488 communication ports
- Single, double, or triple channel feedback
- Process control set point
- Optical isolation of control and feedback inputs for reduced noise interference
- Panel mounted microterminal for local control and monitoring
- Phase loss detection

Typical Applications:

- Motor and compressor testing
- Circuit breaker testing
- Plating rectifier systems
- Quality control testing
- Engineering laboratories
- Industrial processes
- Voltage Regulation



Microprocessor Controller with optional microterminal

The FRC-20 Controller is a versatile, field modifyable controller that has a low install cost and low cost of operation. It is designed to position and regulate any Staco Energy motor driven variable transformer, and can be controlled with a 0-5 VDC or 4-20 mA set point, a 1k ohm potentiometer, or a fixed resistor network. It maintains a full range regulation of 0.5% and a limited range regulation of 0.25%.

The FRC-20 is field configurable for feedback voltage ranges up to 600 volts, for either full range or limited range control. It is small and can be easily mounted on the motor base plate of the variable transformer or inside an enclosure. Current and other feedback alternatives are also available.

Ganged Variable Transformer Assemblies

High Current Models

By ganging the variable transformers with a common rotor shaft, and wiring the outputs in parallel, the output current can be greatly increased. The models listed on this page are capable of output currents up to 540 amps. Other models are available in a variety of ranges. Please refer to our Variable Transformer Voltage Control Catalog (VT-5) for additional information.

Three Phase Models

All models of Staco variable transformers can be ganged with a common rotor shaft and wired for three phase operation in either open Delta or Wye configuration. The table below lists a few typical 240 and 480 volt models. Please refer to our Variable Transformer Voltage Control Catalog (VT-5) for additional models.



30M5011-3Y Model

Single Phase Models

Part No.	Input	Output	Current (Amps)	kVA
6011-2P	120	0-120 or 0-140	120.0	16.8
6011-3P			180.0	25.2
6011-4P			240.0	33.6
6011-5P			300.0	42.0
6011-6P			360.0	50.4
6011-7P			420.0	58.8
6011-8P			480.0	67.2
6011-9P			540.0	75.6
6020-2P			240	0-240 or 0-280
6020-3P	105.0	29.4		
6020-4P	140.0	39.2		
6020-5P	175.0	49.0		
6020-6P	210.0	58.8		
6020-7P	245.0	68.6		
6020-8P	280.0	78.4		
6020-9P	315.0	88.2		

Three Phase Models

Part No.	Input	Output	Current (Amps)	kVA	
221B-3	208/120 or 240	0-208/120 or 0-240	2.5	1.0	
291-3			3.0	1.25	
501C-3			5.0	2.1	
1010B-3		208/120 input	0-240 with 240 input	10.0	4.2
1510-3				15.0	6.2
2510-3				25.0	10.4
6011-3Y				60.0	24.9
6011-6Y				120.0	49.8
6011-9Y				180.0	74.7
M6011-12Y				240.0	99.6
M6011-15Y				300.0	124.5
M6011-18Y				360.0	149.4
M6011-21Y				420.0	174.3
M6011-24Y		480.0	199.2		
M6011-27Y		540.0	224.1		
M6011-30Y		600.0	249.0		
M6011-33Y		660.0	273.9		
M6011-36Y		720.0	298.8		
1020B-3		480/277 or 480	0-480/277 or 0-560 with 480/277 input	3.5	3.4
1520-3	9.5			9.2	
2520-3	10.0			9.7	
6020-3Y*	35.0			33.9	
6020-6Y	70.0			67.8	
6020-9Y	105.0			101.7	
M6020-12Y	140.0			135.6	
M6020-15Y	175.0			169.5	
M6020-18Y	210.0			203.5	
M6020-21Y	245.0			237.4	
M6020-24Y	280.0			271.3	
M6020-27Y	315.0			305.1	
M6020-30Y	350.0			339.1	
M6020-33Y	385.0			373.0	
M6020-36Y	420.0			406.9	

* All 6020 Three Phase Models are rated for 575 volts 60 Hz input, 0-575 volts output.

Service Options

With our ServiStar® program, a wide range of planned maintenance and extended service options are offered to maximize equipment life and reliability of your FirstLine® UPS. Through an extensive network of factory trained professionals you receive:

- Annual Service Plan
- 24/7 Emergency Service
- Preventive Maintenance
- Programs tailored to meet your needs

About Staco Energy Products

Since 1937, customers worldwide have been relying on Staco Energy Products Company to deliver voltage control and power quality solutions tailored to their needs.

As a leading power quality resource, we offer our customers world-class support; from our thorough applications assessment, to our ability to design and deliver a solution that is tailored to the specific needs of our customers; through delivery and commissioning.

Our professional, factory trained service team is in place to ensure that our customers' revenues are protected, and their investment provides them with many years of trouble free operation.

Staco develops total power solutions for OEM and end user applications.

In addition to Variable Transformers we offer a wide array of power quality products, including:

- **Uninterruptible Power Supplies**
- **Power Conditioners**
- **Voltage Regulators**
- **Power Factor Correction and Harmonic Mitigation**
- **Active Harmonic Filters**
- **Variable Transformers**
- **Custom Engineered Test Sets**



**STACO
ENERGY®
PRODUCTS CO.**

Your Tailored Power Solutions Provider™

©2014 Staco Energy Products Co.

VT-Prod-guide_042514

Contact Us:

US Toll Free: 866-261-1191

Phone: 937-253-1191

E-mail: sales@stacoenergy.com

ISO
9001:2008
CERTIFIED

For more information about Variable Transformers

www.stacoenergy.com



Стандарт Электрон Связь

Мы молодая и активно развивающаяся компания в области поставок электронных компонентов. Мы поставляем электронные компоненты отечественного и импортного производства напрямую от производителей и с крупнейших складов мира.

Благодаря сотрудничеству с мировыми поставщиками мы осуществляем комплексные и плановые поставки широчайшего спектра электронных компонентов.

Собственная эффективная логистика и склад в обеспечивает надежную поставку продукции в точно указанные сроки по всей России.

Мы осуществляем техническую поддержку нашим клиентам и предпродажную проверку качества продукции. На все поставляемые продукты мы предоставляем гарантию .

Осуществляем поставки продукции под контролем ВП МО РФ на предприятия военно-промышленного комплекса России , а также работаем в рамках 275 ФЗ с открытием отдельных счетов в уполномоченном банке. Система менеджмента качества компании соответствует требованиям ГОСТ ISO 9001.

Минимальные сроки поставки, гибкие цены, неограниченный ассортимент и индивидуальный подход к клиентам являются основой для выстраивания долгосрочного и эффективного сотрудничества с предприятиями радиоэлектронной промышленности, предприятиями ВПК и научно-исследовательскими институтами России.

С нами вы становитесь еще успешнее!

Наши контакты:

Телефон: +7 812 627 14 35

Электронная почта: sales@st-electron.ru

Адрес: 198099, Санкт-Петербург,
Промышленная ул, дом № 19, литера Н,
помещение 100-Н Офис 331