

165-Bump BGA
Commercial Temp
Industrial Temp

288Mb SigmaQuad-II™
Burst of 4 SRAM

400 MHz–250 MHz
1.8 V V_{DD}
1.8 V and 1.5 V I/O

Features

- Simultaneous Read and Write SigmaQuad™ Interface
- JEDEC-standard pinout and package
- Dual Double Data Rate interface
- Byte Write controls sampled at data-in time
- Burst of 4 Read and Write
- 1.8 V +100/-100 mV core power supply
- 1.5 V or 1.8 V HSTL Interface
- Pipelined read operation
- Fully coherent read and write pipelines
- ZQ pin for programmable output drive strength
- IEEE 1149.1 JTAG-compliant Boundary Scan
- Pin-compatible with present 144 Mb devices
- RoHS-compliant 165-bump BGA package

SigmaQuad™ Family Overview

The GS82582D18/36GE are built in compliance with the SigmaQuad-II SRAM pinout standard for Separate I/O synchronous SRAMs. They are 301,989,888-bit (288Mb) SRAMs. The GS82582D18/36GE SigmaQuad SRAMs are just one element in a family of low power, low voltage HSTL I/O SRAMs designed to operate at the speeds needed to implement economical high performance networking systems.

Clocking and Addressing Schemes

The GS82582D18/36GE SigmaQuad-II SRAMs are synchronous devices. They employ two input register clock inputs, K and \bar{K} . K and \bar{K} are independent single-ended clock inputs, not differential inputs to a single differential clock input buffer. The device also allows the user to manipulate the output register clock inputs quasi independently with the C and \bar{C} clock inputs. C and \bar{C} are also independent single-ended clock inputs, not differential inputs. If the C clocks are tied high, the K clocks are routed internally to fire the output registers instead.

Each internal read and write operation in a SigmaQuad-II B4 RAM is four times wider than the device I/O bus. An input data bus de-multiplexer is used to accumulate incoming data before it is simultaneously written to the memory array. An output data multiplexer is used to capture the data produced from a single memory array read and then route it to the appropriate output drivers as needed. Therefore the address field of a SigmaQuad-II B4 RAM is always two address pins less than the advertised index depth (e.g., the 16M x 18 has an 4M addressable index).

Parameter Synopsis

| | -400 | -375 | -333 | -300 | -250 |
|-------------------|---------|---------|---------|---------|---------|
| t _{KHKH} | 2.5 ns | 2.66 ns | 3.0 ns | 3.3 ns | 4.0 ns |
| t _{KHOV} | 0.45 ns | 0.45 ns | 0.45 ns | 0.45 ns | 0.45 ns |

8M x 36 SigmaQuad-II SRAM—Top View

| | 1 | 2 | 3 | 4 | 5 | 6 | 7 | 8 | 9 | 10 | 11 |
|---|--------------------------|-----------|-----------|-----------------------|-------------------------|-----------------------|-------------------------|-----------------------|-----------|-----------|-----|
| A | $\overline{\text{CQ}}$ | SA | SA | $\overline{\text{W}}$ | $\overline{\text{BW2}}$ | $\overline{\text{K}}$ | $\overline{\text{BW1}}$ | $\overline{\text{R}}$ | SA | SA | CQ |
| B | Q27 | Q18 | D18 | SA | $\overline{\text{BW3}}$ | K | $\overline{\text{BW0}}$ | SA | D17 | Q17 | Q8 |
| C | D27 | Q28 | D19 | V_{SS} | SA | NC | SA | V_{SS} | D16 | Q7 | D8 |
| D | D28 | D20 | Q19 | V_{SS} | V_{SS} | V_{SS} | V_{SS} | V_{SS} | Q16 | D15 | D7 |
| E | Q29 | D29 | Q20 | V_{DDQ} | V_{SS} | V_{SS} | V_{SS} | V_{DDQ} | Q15 | D6 | Q6 |
| F | Q30 | Q21 | D21 | V_{DDQ} | V_{DD} | V_{SS} | V_{DD} | V_{DDQ} | D14 | Q14 | Q5 |
| G | D30 | D22 | Q22 | V_{DDQ} | V_{DD} | V_{SS} | V_{DD} | V_{DDQ} | Q13 | D13 | D5 |
| H | $\overline{\text{Doff}}$ | V_{REF} | V_{DDQ} | V_{DDQ} | V_{DD} | V_{SS} | V_{DD} | V_{DDQ} | V_{DDQ} | V_{REF} | ZQ |
| J | D31 | Q31 | D23 | V_{DDQ} | V_{DD} | V_{SS} | V_{DD} | V_{DDQ} | D12 | Q4 | D4 |
| K | Q32 | D32 | Q23 | V_{DDQ} | V_{DD} | V_{SS} | V_{DD} | V_{DDQ} | Q12 | D3 | Q3 |
| L | Q33 | Q24 | D24 | V_{DDQ} | V_{SS} | V_{SS} | V_{SS} | V_{DDQ} | D11 | Q11 | Q2 |
| M | D33 | Q34 | D25 | V_{SS} | V_{SS} | V_{SS} | V_{SS} | V_{SS} | D10 | Q1 | D2 |
| N | D34 | D26 | Q25 | V_{SS} | SA | SA | SA | V_{SS} | Q10 | D9 | D1 |
| P | Q35 | D35 | Q26 | SA | SA | C | SA | SA | Q9 | D0 | Q0 |
| R | TDO | TCK | SA | SA | SA | $\overline{\text{C}}$ | SA | SA | SA | TMS | TDI |

 11 x 15 Bump BGA—15 x 17 mm² Body—1 mm Bump Pitch

Note:

$\overline{\text{BW0}}$ controls writes to D0:D8; $\overline{\text{BW1}}$ controls writes to D9:D17; $\overline{\text{BW2}}$ controls writes to D18:D26; $\overline{\text{BW3}}$ controls writes to D27:D35.

16M x 18 SigmaQuad-II SRAM—Top View

| | 1 | 2 | 3 | 4 | 5 | 6 | 7 | 8 | 9 | 10 | 11 |
|---|--------------------------|-----------|-----------|-----------------------|-------------------------|-----------------------|-------------------------|-----------------------|-----------|-----------|-----|
| A | $\overline{\text{CQ}}$ | SA | SA | $\overline{\text{W}}$ | $\overline{\text{BW1}}$ | $\overline{\text{K}}$ | SA | $\overline{\text{R}}$ | SA | SA | CQ |
| B | NC | Q9 | D9 | SA | NC | K | $\overline{\text{BW0}}$ | SA | NC | NC | Q8 |
| C | NC | NC | D10 | V_{SS} | SA | NC | SA | V_{SS} | NC | Q7 | D8 |
| D | NC | D11 | Q10 | V_{SS} | V_{SS} | V_{SS} | V_{SS} | V_{SS} | NC | NC | D7 |
| E | NC | NC | Q11 | V_{DDQ} | V_{SS} | V_{SS} | V_{SS} | V_{DDQ} | NC | D6 | Q6 |
| F | NC | Q12 | D12 | V_{DDQ} | V_{DD} | V_{SS} | V_{DD} | V_{DDQ} | NC | NC | Q5 |
| G | NC | D13 | Q13 | V_{DDQ} | V_{DD} | V_{SS} | V_{DD} | V_{DDQ} | NC | NC | D5 |
| H | $\overline{\text{Doff}}$ | V_{REF} | V_{DDQ} | V_{DDQ} | V_{DD} | V_{SS} | V_{DD} | V_{DDQ} | V_{DDQ} | V_{REF} | ZQ |
| J | NC | NC | D14 | V_{DDQ} | V_{DD} | V_{SS} | V_{DD} | V_{DDQ} | NC | Q4 | D4 |
| K | NC | NC | Q14 | V_{DDQ} | V_{DD} | V_{SS} | V_{DD} | V_{DDQ} | NC | D3 | Q3 |
| L | NC | Q15 | D15 | V_{DDQ} | V_{SS} | V_{SS} | V_{SS} | V_{DDQ} | NC | NC | Q2 |
| M | NC | NC | D16 | V_{SS} | V_{SS} | V_{SS} | V_{SS} | V_{SS} | NC | Q1 | D2 |
| N | NC | D17 | Q16 | V_{SS} | SA | SA | SA | V_{SS} | NC | NC | D1 |
| P | NC | NC | Q17 | SA | SA | C | SA | SA | NC | D0 | Q0 |
| R | TDO | TCK | SA | SA | SA | $\overline{\text{C}}$ | SA | SA | SA | TMS | TDI |

 11 x 15 Bump BGA—15 x 17 mm² Body—1 mm Bump Pitch

Note:

 BW0 controls writes to D0:D8. $\overline{\text{BW1}}$ controls writes to D9:D17.

Pin Description Table

| Symbol | Description | Type | Comments |
|----------------------|---------------------------------|--------|----------------------|
| SA | Synchronous Address Inputs | Input | — |
| \overline{R} | Synchronous Read | Input | Active Low |
| \overline{W} | Synchronous Write | Input | Active Low |
| $\overline{BW0-BW3}$ | Synchronous Byte Writes | Input | Active Low |
| K | Input Clock | Input | Active High |
| \overline{K} | Input Clock | Input | Active Low |
| C | Output Clock | Input | Active High |
| \overline{C} | Output Clock | Input | Active Low |
| TMS | Test Mode Select | Input | — |
| TDI | Test Data Input | Input | — |
| TCK | Test Clock Input | Input | — |
| TDO | Test Data Output | Output | — |
| V _{REF} | HSTL Input Reference Voltage | Input | — |
| ZQ | Output Impedance Matching Input | Input | — |
| Qn | Synchronous Data Outputs | Output | — |
| Dn | Synchronous Data Inputs | Input | — |
| \overline{D}_{off} | Disable DLL when low | Input | Active Low |
| CQ | Output Echo Clock | Output | — |
| \overline{CQ} | Output Echo Clock | Output | — |
| V _{DD} | Power Supply | Supply | 1.8 V Nominal |
| V _{DDQ} | Isolated Output Buffer Supply | Supply | 1.5 or 1.8 V Nominal |
| V _{SS} | Power Supply: Ground | Supply | — |
| NC | No Connect | — | — |

Notes:

1. NC = Not Connected to die or any other pin
2. When ZQ pin is directly connected to V_{DDQ}, output impedance is set to minimum value and it cannot be connected to ground or left unconnected.
3. C, \overline{C} , K, \overline{K} cannot be set to V_{REF} voltage.

Background

Separate I/O SRAMs, from a system architecture point of view, are attractive in applications where alternating reads and writes are needed. Therefore, the SigmaQuad-II SRAM interface and truth table are optimized for alternating reads and writes. Separate I/O SRAMs are unpopular in applications where multiple reads or multiple writes are needed because burst read or write transfers from Separate I/O SRAMs can cut the RAM's bandwidth in half.

SigmaQuad-II B4 SRAM DDR Read

The status of the Address Input, \overline{W} , and \overline{R} pins are sampled by the rising edges of K. \overline{W} and \overline{R} high causes chip disable. A low on the Read Enable-bar pin, \overline{R} , begins a read cycle. \overline{R} is always ignored if the previous command loaded was a read command. Data can be clocked out after the next rising edge of K with a rising edge of \overline{C} (or by \overline{K} if C and \overline{C} are tied high), after the following rising edge of \overline{K} with a rising edge of C (or by K if C and \overline{C} are tied high), after the next rising edge of K with a rising edge of \overline{C} , and after the following rising edge of \overline{K} with a rising edge of C. Clocking in a high on the Read Enable-bar pin, \overline{R} , begins a read port deselect cycle.

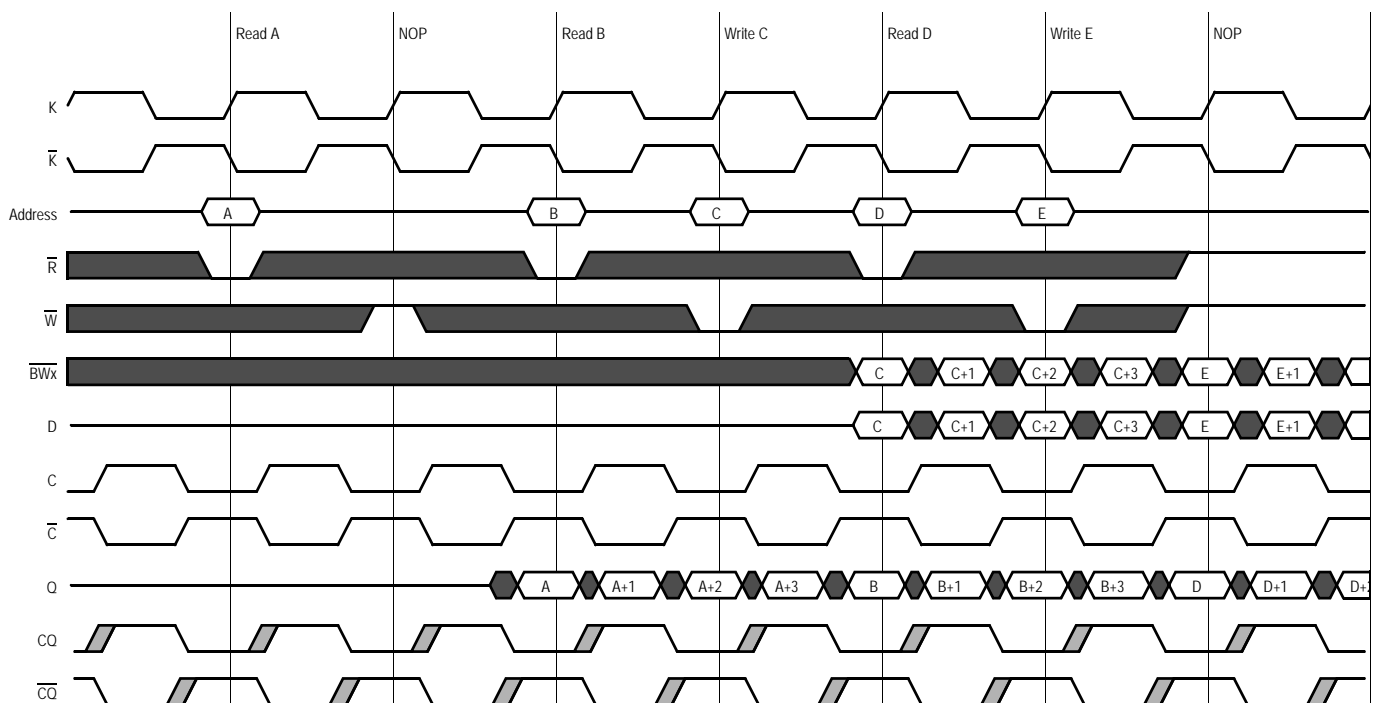

SigmaQuad-II B4 SRAM DDR Write

The status of the Address Input, \overline{W} , and \overline{R} pins are sampled by the rising edges of K. \overline{W} and \overline{R} high causes chip disable. A low on the Write Enable-bar pin, \overline{W} , and a high on the Read Enable-bar pin, \overline{R} , begins a write cycle. \overline{W} is always ignored if the previous command was a write command. Data is clocked in by the next rising edge of K, the rising edge of \overline{K} after that, the next rising edge of K, and finally by the next rising edge of \overline{K} .

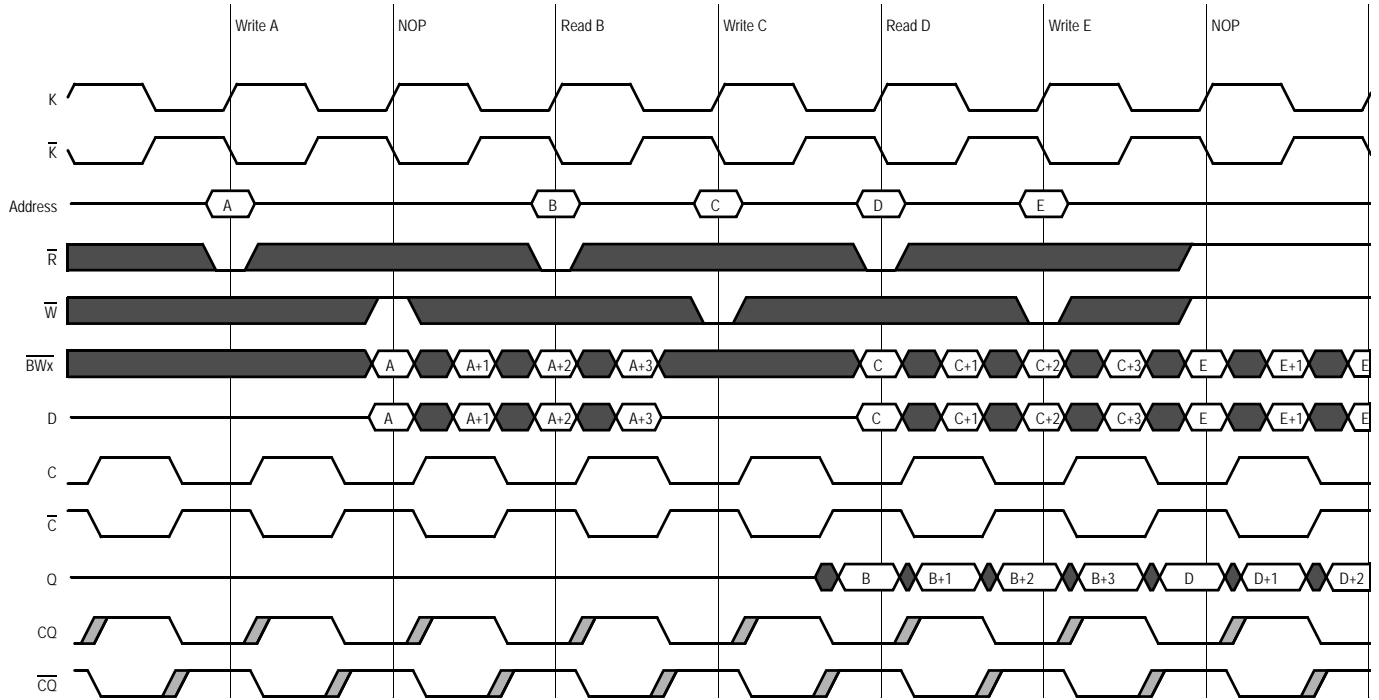

Special Functions

Byte Write Control

Byte Write Enable pins are sampled at the same time that Data In is sampled. A high on the Byte Write Enable pin associated with a particular byte (e.g., $\overline{BW0}$ controls D0–D8 inputs) will inhibit the storage of that particular byte, leaving whatever data may be stored at the current address at that byte location undisturbed. Any or all of the Byte Write Enable pins may be driven high or low during the data in sample times in a write sequence.

Each write enable command and write address loaded into the RAM provides the base address for a 4 beat data transfer. The x18 version of the RAM, for example, may write 72 bits in association with each address loaded. Any 9-bit byte may be masked in any write sequence.

Example x18 RAM Write Sequence using Byte Write Enables

| Data In Sample Time | $\overline{BW0}$ | $\overline{BW1}$ | D0–D8 | D9–D17 |
|---------------------|------------------|------------------|------------|------------|
| Beat 1 | 0 | 1 | Data In | Don't Care |
| Beat 2 | 1 | 0 | Don't Care | Data In |
| Beat 3 | 0 | 0 | Data In | Data In |
| Beat 4 | 1 | 0 | Don't Care | Data In |

Resulting Write Operation

| Byte 1 D0–D8 | Byte 2 D9–D17 | Byte 1 D0–D8 | Byte 2 D9–D17 | Byte 1 D0–D8 | Byte 2 D9–D17 | Byte 1 D0–D8 | Byte 2 D9–D17 |
|-----------------|------------------|-----------------|------------------|-----------------|------------------|-----------------|------------------|
| Written | Unchanged | Unchanged | Written | Written | Written | Unchanged | Written |
| Beat 1 | | Beat 2 | | Beat 3 | | Beat 4 | |

Output Register Control

SigmaQuad-II SRAMs offer two mechanisms for controlling the output data registers. Typically, control is handled by the Output Register Clock inputs, C and \overline{C} . The Output Register Clock inputs can be used to make small phase adjustments in the firing of the output registers by allowing the user to delay driving data out as much as a few nanoseconds beyond the next rising edges of the K and \overline{K} clocks. If the C and \overline{C} clock inputs are tied high, the RAM reverts to K and \overline{K} control of the outputs, allowing the RAM to function as a conventional pipelined read SRAM.

Example Four Bank Depth Expansion Schematic

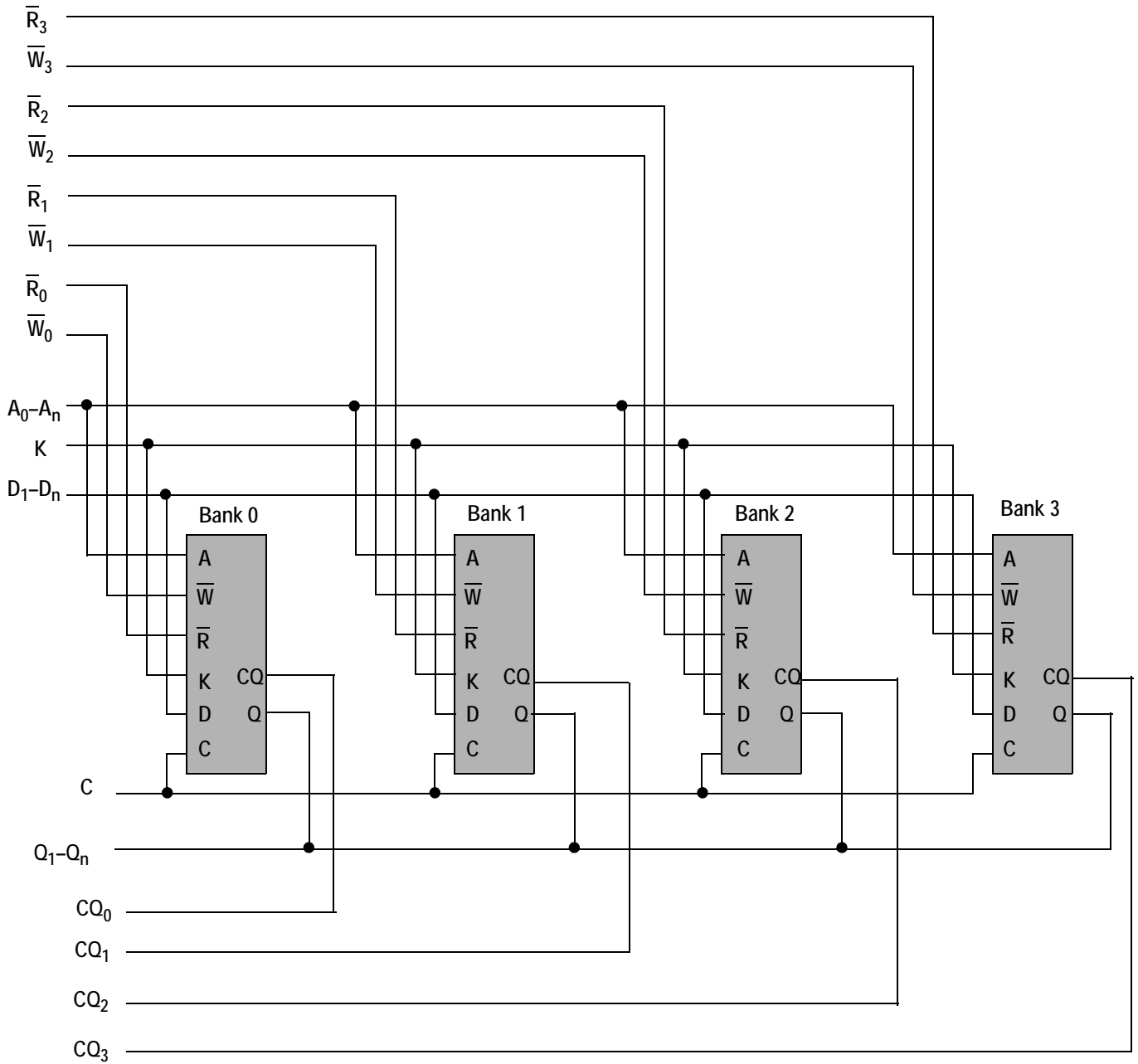

Note:
For simplicity $\bar{B}W_n$, \bar{K} , and \bar{C} are not shown.

Burst of 4 SigmaQuad-II SRAM Depth Expansion

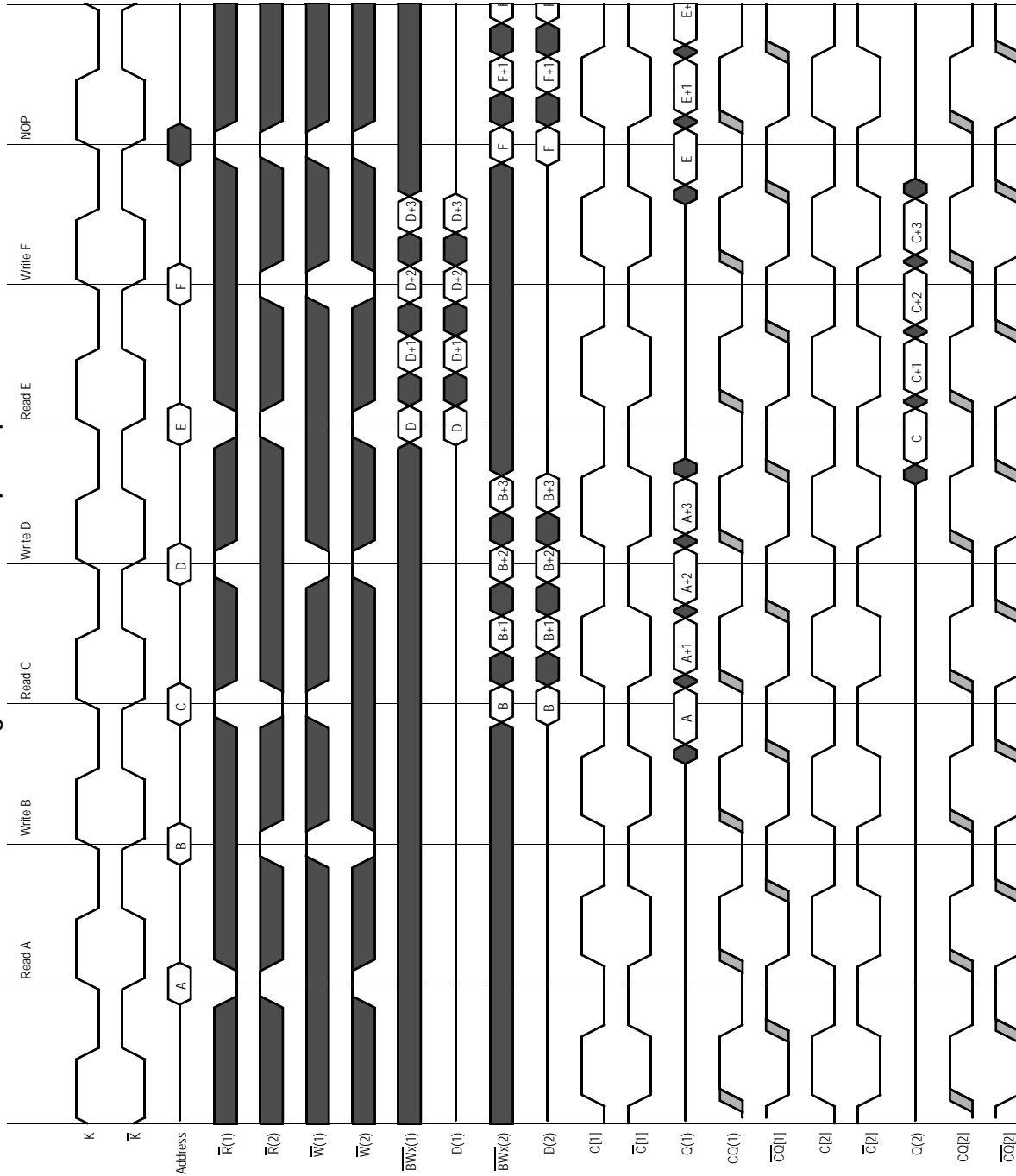

FLXDrive-II Output Driver Impedance Control

HSTL I/O SigmaQuad-II SRAMs are supplied with programmable impedance output drivers. The ZQ pin must be connected to V_{SS} via an external resistor, RQ, to allow the SRAM to monitor and adjust its output driver impedance. The value of RQ must be 5X the value of the desired RAM output impedance. The allowable range of RQ to guarantee impedance matching continuously is between 175Ω and 350Ω . Periodic readjustment of the output driver impedance is necessary as the impedance is affected by drifts in supply voltage and temperature. The SRAM's output impedance circuitry compensates for drifts in supply voltage and temperature. A clock cycle counter periodically triggers an impedance evaluation, resets and counts again. Each impedance evaluation may move the output driver impedance level one step at a time towards the optimum level. The output driver is implemented with discrete binary weighted impedance steps.

Power-Up Initialization

After power-up, stable input clocks must be applied to the device for $20\ \mu s$ prior to issuing read and write commands. See the t_{KInit} timing parameter in the **AC Electrical Characteristics** section.

Note:

The t_{KInit} requirement is independent of the t_{Lock} requirement, which specifies how many cycles of stable input clocks (2048) must be applied after the \overline{Doff} pin has been driven High in order to ensure that the DLL locks properly (and the DLL must lock properly before issuing read and write commands). However, t_{KInit} is greater than t_{KLock} , even at the slowest permitted cycle time of $8.4\ ns$ ($2048 * 8.4\ ns = 17.2\ \mu s$). Consequently, the $20\ \mu s$ associated with t_{KInit} is sufficient to cover the t_{KLock} requirement at power-up if the \overline{Doff} pin is driven High prior to the start of the $20\ \mu s$ period.

Also, t_{KInit} only needs to be met once, immediately after power-up, whereas t_{KLock} must be met any time the DLL is disabled/reset (whether by toggling \overline{Doff} Low or by stopping K clocks for $> 30\ ns$).

x36 Byte Write Enable (\overline{BwN}) Truth Table

| $\overline{BW0}$ | $\overline{BW1}$ | $\overline{BW2}$ | $\overline{BW3}$ | D0–D8 | D9–D17 | D18–D26 | D27–D35 |
|------------------|------------------|------------------|------------------|------------|------------|------------|------------|
| 1 | 1 | 1 | 1 | Don't Care | Don't Care | Don't Care | Don't Care |
| 0 | 1 | 1 | 1 | Data In | Don't Care | Don't Care | Don't Care |
| 1 | 0 | 1 | 1 | Don't Care | Data In | Don't Care | Don't Care |
| 0 | 0 | 1 | 1 | Data In | Data In | Don't Care | Don't Care |
| 1 | 1 | 0 | 1 | Don't Care | Don't Care | Data In | Don't Care |
| 0 | 1 | 0 | 1 | Data In | Don't Care | Data In | Don't Care |
| 1 | 0 | 0 | 1 | Don't Care | Data In | Data In | Don't Care |
| 0 | 0 | 0 | 1 | Data In | Data In | Data In | Don't Care |
| 1 | 1 | 1 | 0 | Don't Care | Don't Care | Don't Care | Data In |
| 0 | 1 | 1 | 0 | Data In | Don't Care | Don't Care | Data In |
| 1 | 0 | 1 | 0 | Don't Care | Data In | Don't Care | Data In |
| 0 | 0 | 1 | 0 | Data In | Data In | Don't Care | Data In |
| 1 | 1 | 0 | 0 | Don't Care | Don't Care | Data In | Data In |
| 0 | 1 | 0 | 0 | Data In | Don't Care | Data In | Data In |
| 1 | 0 | 0 | 0 | Don't Care | Data In | Data In | Data In |
| 0 | 0 | 0 | 0 | Data In | Data In | Data In | Data In |

x18 Byte Write Enable (\overline{BWn}) Truth Table

| $\overline{BW0}$ | $\overline{BW1}$ | D0-D8 | D9-D17 |
|------------------|------------------|------------|------------|
| 1 | 1 | Don't Care | Don't Care |
| 0 | 1 | Data In | Don't Care |
| 1 | 0 | Don't Care | Data In |
| 0 | 0 | Data In | Data In |

Absolute Maximum Ratings

(All voltages reference to V_{SS})

| Symbol | Description | Value | Unit |
|-----------|-------------------------------|--|--------------------|
| V_{DD} | Voltage on V_{DD} Pins | -0.5 to 2.9 | V |
| V_{DDQ} | Voltage in V_{DDQ} Pins | -0.5 to V_{DD} | V |
| V_{REF} | Voltage in V_{REF} Pins | -0.5 to V_{DDQ} | V |
| $V_{I/O}$ | Voltage on I/O Pins | -0.5 to $V_{DDQ} + 0.5$ (≤ 2.9 V max.) | V |
| V_{IN} | Voltage on Other Input Pins | -0.5 to $V_{DDQ} + 0.5$ (≤ 2.9 V max.) | V |
| I_{IN} | Input Current on Any Pin | +/-100 | mA dc |
| I_{OUT} | Output Current on Any I/O Pin | +/-100 | mA dc |
| T_J | Maximum Junction Temperature | 125 | $^{\circ}\text{C}$ |
| T_{STG} | Storage Temperature | -55 to 125 | $^{\circ}\text{C}$ |

Note:

Permanent damage to the device may occur if the Absolute Maximum Ratings are exceeded. Operation should be restricted to Recommended Operating Conditions. Exposure to conditions exceeding the Recommended Operating Conditions, for an extended period of time, may affect reliability of this component.

Recommended Operating Conditions

Power Supplies

| Parameter | Symbol | Min. | Typ. | Max. | Unit |
|--------------------|-----------|------|------|----------|------|
| Supply Voltage | V_{DD} | 1.7 | 1.8 | 1.9 | V |
| I/O Supply Voltage | V_{DDQ} | 1.4 | — | V_{DD} | V |
| Reference Voltage | V_{REF} | 0.68 | — | 0.95 | V |

Note:

The power supplies need to be powered up simultaneously or in the following sequence: V_{DD} , V_{DDQ} , V_{REF} , followed by signal inputs. The power down sequence must be the reverse. V_{DDQ} must not exceed V_{DD} . For more information, read **AN1021 SigmaQuad and SigmaDDR Power-Up**.

Operating Temperature

| Parameter | Symbol | Min. | Typ. | Max. | Unit |
|--|--------|------|------|------|--------------------|
| Junction Temperature (Commercial Range Versions) | T_J | 0 | 25 | 85 | $^{\circ}\text{C}$ |
| Junction Temperature (Industrial Range Versions)* | T_J | -40 | 25 | 100 | $^{\circ}\text{C}$ |

Note:

* The part numbers of Industrial Temperature Range versions end with the character "I". Unless otherwise noted, all performance specifications quoted are evaluated for worst case in the temperature range marked on the device.

Thermal Impedance

| Package | Test PCB Substrate | θ_{JA} (C°/W) Airflow = 0 m/s | θ_{JA} (C°/W) Airflow = 1 m/s | θ_{JA} (C°/W) Airflow = 2 m/s | θ_{JB} (C°/W) | θ_{JC} (C°/W) |
|---------|--------------------|---|---|---|----------------------|----------------------|
| 165 BGA | 4-layer | 16.10 | 13.69 | 12.73 | 6.54 | 2.08 |

Notes:

1. Thermal Impedance data is based on a number of samples from multiple lots and should be viewed as a typical number.
2. Please refer to JEDEC standard JESD51-6.
3. The characteristics of the test fixture PCB influence reported thermal characteristics of the device. Be advised that a good thermal path to the PCB can result in cooling or heating of the RAM depending on PCB temperature.

HSTL I/O DC Input Characteristics

| Parameter | Symbol | Min | Max | Units | Notes |
|---------------------|---------------|-----------------|-----------------|-------|-------|
| DC Input Logic High | V_{IH} (dc) | $V_{REF} + 0.1$ | $V_{DDQ} + 0.3$ | V | 1 |
| DC Input Logic Low | V_{IL} (dc) | -0.3 | $V_{REF} - 0.1$ | V | 1 |

Notes:

1. Compatible with both 1.8 V and 1.5 V I/O drivers.
2. These are DC test criteria. DC design criteria is $V_{REF} \pm 50$ mV. The AC V_{IH}/V_{IL} levels are defined separately for measuring timing parameters.
3. V_{IL} (Min)DC = -0.3 V, V_{IL} (Min)AC = -1.5 V (pulse width ≤ 3 ns).
4. V_{IH} (Max)DC = $V_{DDQ} + 0.3$ V, V_{IH} (Max)AC = $V_{DDQ} + 0.85$ V (pulse width ≤ 3 ns).

HSTL I/O AC Input Characteristics

| Parameter | Symbol | Min | Max | Units | Notes |
|-----------------------------------|----------------|-----------------|-------------------|-------|-------|
| AC Input Logic High | V_{IH} (ac) | $V_{REF} + 200$ | — | mV | 2,3 |
| AC Input Logic Low | V_{IL} (ac) | — | $V_{REF} - 200$ | mV | 2,3 |
| V_{REF} Peak-to-Peak AC Voltage | V_{REF} (ac) | — | 5% V_{REF} (DC) | mV | 1 |

Notes:

1. The peak-to-peak AC component superimposed on V_{REF} may not exceed 5% of the DC component of V_{REF} .
2. To guarantee AC characteristics, V_{IH}, V_{IL} , Trise, and Tfall of inputs and clocks must be within 10% of each other.
3. For devices supplied with HSTL I/O input buffers. Compatible with both 1.8 V and 1.5 V I/O drivers.

Undershoot Measurement and Timing

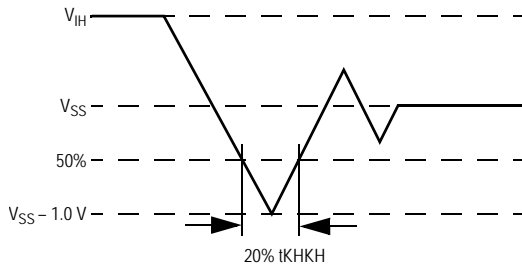

Overshoot Measurement and Timing

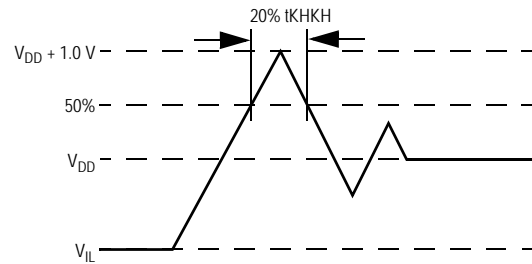

Capacitance

($T_A = 25^\circ\text{C}$, $f = 1\text{ MHz}$, $V_{DD} = 1.8\text{ V}$)

| Parameter | Symbol | Test conditions | Typ. | Max. | Unit |
|--------------------|-----------|------------------------|------|------|------|
| Input Capacitance | C_{IN} | $V_{IN} = 0\text{ V}$ | 4 | 5 | pF |
| Output Capacitance | C_{OUT} | $V_{OUT} = 0\text{ V}$ | 6 | 7 | pF |
| Clock Capacitance | C_{CLK} | $V_{IN} = 0\text{ V}$ | 5 | 6 | pF |

Note:

This parameter is sample tested.

AC Test Conditions

| Parameter | Conditions |
|------------------------|-------------|
| Input high level | 1.25 V |
| Input low level | 0.25 V |
| Max. input slew rate | 2 V/ns |
| Input reference level | 0.75 V |
| Output reference level | $V_{DDQ}/2$ |

Note:

Test conditions as specified with output loading as shown unless otherwise noted.

AC Test Load Diagram

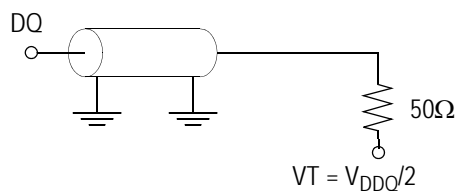

$R_Q = 250\ \Omega$ (HSTL I/O)
 $V_{REF} = 0.75\text{ V}$

Input and Output Leakage Characteristics

| Parameter | Symbol | Test Conditions | Min. | Max |
|---|--------------------------------|---|-------------|-----------|
| Input Leakage Current (except mode pins) | I_{IL} | $V_{IN} = 0$ to V_{DD} | -2 μ A | 2 μ A |
| $\overline{\text{Doff}}$ | $I_{IL\overline{\text{DOFF}}}$ | $V_{IN} = 0$ to V_{DD} | -20 μ A | 2 μ A |
| Output Leakage Current | I_{OL} | Output Disable, $V_{OUT} = 0$ to V_{DDQ} | -2 μ A | 2 μ A |

Programmable Impedance HSTL Output Driver DC Electrical Characteristics

| Parameter | Symbol | Min. | Max. | Units | Notes |
|---------------------|-----------|--------------------|--------------------|-------|-------|
| Output High Voltage | V_{OH1} | $V_{DDQ}/2 - 0.12$ | $V_{DDQ}/2 + 0.12$ | V | 1, 3 |
| Output Low Voltage | V_{OL1} | $V_{DDQ}/2 - 0.12$ | $V_{DDQ}/2 + 0.12$ | V | 2, 3 |
| Output High Voltage | V_{OH2} | $V_{DDQ} - 0.2$ | V_{DDQ} | V | 4, 5 |
| Output Low Voltage | V_{OL2} | V_{SS} | 0.2 | V | 4, 6 |

Notes:

- $I_{OH} = (V_{DDQ}/2) / (RQ/5) \pm 15\%$ @ $V_{OH} = V_{DDQ}/2$ (for: $175\Omega \leq RQ \leq 350\Omega$).
- $I_{OL} = (V_{DDQ}/2) / (RQ/5) \pm 15\%$ @ $V_{OL} = V_{DDQ}/2$ (for: $175\Omega \leq RQ \leq 350\Omega$).
- Parameter tested with $RQ = 250\Omega$ and $V_{DDQ} = 1.5$ V or 1.8 V
- $0\Omega \leq RQ \leq \infty\Omega$
- $I_{OH} = -1.0$ mA
- $I_{OL} = 1.0$ mA

Operating Currents

| Parameter | Symbol | Test Conditions | -400 | | -375 | | -333 | | -300 | | -250 | | Unit | Notes |
|------------------------------|-----------|---|-----------|-------------|-----------|-------------|-----------|-------------|-----------|-------------|-----------|-------------|------|-------|
| | | | 0 to 70°C | -40 to 85°C | 0 to 70°C | -40 to 85°C | 0 to 70°C | -40 to 85°C | 0 to 70°C | -40 to 85°C | 0 to 70°C | -40 to 85°C | | |
| Operating Current (x36): DDR | I_{DD} | $V_{DD} = \text{Max}$, $I_{OUT} = 0 \text{ mA}$ Cycle Time $\geq t_{KHK}$ Min | 1070 | 1090 | 1020 | 1040 | 940 | 960 | 880 | 900 | 780 | 800 | mA | 2, 3 |
| Operating Current (x18): DDR | I_{DD} | $V_{DD} = \text{Max}$, $I_{OUT} = 0 \text{ mA}$ Cycle Time $\geq t_{KHK}$ Min | 880 | 900 | 840 | 860 | 780 | 800 | 730 | 750 | 650 | 670 | mA | 2, 3 |
| Standby Current (NOP): DDR | I_{SB1} | Device deselected, $I_{OUT} = 0 \text{ mA}$, $f = \text{Max}$, All Inputs $\leq 0.2 \text{ V}$ or $\geq V_{DD} - 0.2 \text{ V}$ | 470 | 490 | 450 | 470 | 420 | 440 | 400 | 420 | 360 | 380 | mA | 2, 4 |

Notes:

1. Power measured with output pins floating.
2. Minimum cycle, $I_{OUT} = 0 \text{ mA}$
3. Operating current is calculated with 50% read cycles and 50% write cycles.
4. Standby Current is only after all pending read and write burst operations are completed.

AC Electrical Characteristics

| Parameter | Symbol | -400 | | -375 | | -333 | | -300 | | -250 | | Units | Notes |
|---|--|-------|------|-------|------|-------|------|-------|------|-------|------|---------|-------|
| | | Min | Max | Min | Max | Min | Max | Min | Max | Min | Max | | |
| Clock | | | | | | | | | | | | | |
| K, \overline{K} Clock Cycle Time C, C Clock Cycle Time | t_{KHKH} t_{CHCH} | 2.5 | 8.4 | 2.66 | 8.4 | 3.0 | 8.4 | 3.3 | 8.4 | 4.0 | 8.4 | ns | |
| tKC Variable | t_{KCVar} | — | 0.2 | — | 0.2 | — | 0.2 | — | 0.2 | — | 0.2 | ns | 6 |
| K, \overline{K} Clock High Pulse Width C, C Clock High Pulse Width | t_{KHKL} t_{CHCL} | 1.0 | — | 1.06 | — | 1.2 | — | 1.32 | — | 1.6 | — | ns | |
| K, \overline{K} Clock Low Pulse Width C, C Clock Low Pulse Width | t_{KLKH} t_{CLCH} | 1.0 | — | 1.06 | — | 1.2 | — | 1.32 | — | 1.6 | — | ns | |
| K to \overline{K} High C to C High | $t_{KH\overline{H}}$ $t_{CH\overline{C}}$ | 1.05 | — | 1.13 | — | 1.35 | — | 1.49 | — | 1.8 | — | ns | |
| \overline{K} to K High C to C High | $t_{\overline{K}KH}$ $t_{\overline{C}CH}$ | 1.05 | — | 1.13 | — | 1.35 | — | 1.49 | — | 1.8 | — | ns | |
| K, \overline{K} Clock High to C, \overline{C} Clock High | t_{KHCH} | 0 | 1.13 | 0 | 1.21 | 0 | 1.35 | 0 | 1.49 | 0 | 1.8 | ns | |
| DLL Lock Time | t_{KLock} | 1024 | — | 1024 | — | 1024 | — | 1024 | — | 1024 | — | cycle | 7 |
| K Static to DLL reset | t_{KReset} | 30 | — | 30 | — | 30 | — | 30 | — | 30 | — | ns | |
| K, \overline{K} Clock Initialization | t_{KInit} | 20 | — | 20 | — | 20 | — | 20 | — | 20 | — | μ s | 9 |
| Output Times | | | | | | | | | | | | | |
| K, \overline{K} Clock High to Data Output Valid C, C Clock High to Data Output Valid | t_{KHQV} t_{CHQV} | — | 0.45 | — | 0.45 | — | 0.45 | — | 0.45 | — | 0.45 | ns | 4 |
| K, \overline{K} Clock High to Data Output Hold C, C Clock High to Data Output Hold | t_{KHQX} t_{CHQX} | -0.45 | — | -0.45 | — | -0.45 | — | -0.45 | — | -0.45 | — | ns | 4 |
| K, \overline{K} Clock High to Echo Clock Valid C, C Clock High to Echo Clock Valid | t_{KHCOV} t_{CHCOV} | — | 0.45 | — | 0.45 | — | 0.45 | — | 0.45 | — | 0.45 | ns | |
| K, \overline{K} Clock High to Echo Clock Hold C, C Clock High to Echo Clock Hold | t_{KHCOX} t_{CHCOX} | -0.45 | — | -0.45 | — | -0.45 | — | -0.45 | — | -0.45 | — | ns | |
| CQ, \overline{CQ} High Output Valid | t_{COHQV} | — | 0.2 | — | 0.2 | — | 0.25 | — | 0.27 | — | 0.30 | ns | 8 |
| CQ, \overline{CQ} High Output Hold | t_{COHQX} | -0.2 | — | -0.2 | — | -0.25 | — | -0.27 | — | -0.30 | — | ns | 8 |
| CQ Phase Distortion | $t_{COH\overline{COH}}$ $t_{\overline{CO}HCOH}$ | 1.0 | — | 1.0 | — | 1.10 | — | 1.24 | — | 1.55 | — | ns | |
| K Clock High to Data Output High-Z C Clock High to Data Output High-Z | t_{KHQZ} t_{CHQZ} | — | 0.45 | — | 0.45 | — | 0.45 | — | 0.45 | — | 0.45 | ns | 4 |

Notes:

- All Address inputs must meet the specified setup and hold times for all latching clock edges.
- Control signals are \overline{R} , \overline{W}
- Control signals are $\overline{BW0}$, $\overline{BW1}$ (and $\overline{BW2}$, $\overline{BW3}$ for x36).
- If C, \overline{C} are tied high, K, \overline{K} become the references for C, \overline{C} timing parameters
- To avoid bus contention, at a given voltage and temperature t_{CHQX1} is bigger than t_{CHQZ} . The specs as shown do not imply bus contention because t_{CHQX1} is a MIN parameter that is worst case at totally different test conditions (0°C, 1.9 V) than t_{CHQZ} , which is a MAX parameter (worst case at 70°C, 1.7 V). It is not possible for two SRAMs on the same board to be at such different voltages and temperatures.
- Clock phase jitter is the variance from clock rising edge to the next expected clock rising edge.
- V_{DD} slew rate must be less than 0.1 V DC per 50 ns for DLL lock retention. DLL lock time begins once V_{DD} and input clock are stable.
- Echo clock is very tightly controlled to data valid/data hold. By design, there is a ± 0.1 ns variation from echo clock to data. The datasheet parameters reflect tester guard bands and test setup variations.
- After device power-up, 20 μ s of stable input clocks (as specified by t_{KInit}) must be supplied before reads and writes are issued.

AC Electrical Characteristics (Continued)

| Parameter | Symbol | -400 | | -375 | | -333 | | -300 | | -250 | | Units | Notes |
|--|----------------------------|-------|-----|-------|-----|-------|-----|-------|-----|-------|-----|-------|-------|
| | | Min | Max | Min | Max | Min | Max | Min | Max | Min | Max | | |
| K Clock High to Data Output Low-Z C Clock High to Data Output Low-Z | t_{KHQX1} t_{CHQX1} | -0.45 | — | -0.45 | — | -0.45 | — | -0.45 | — | -0.45 | — | ns | 4 |
| Setup Times | | | | | | | | | | | | | |
| Address Input Setup Time | t_{AVKH} | 0.4 | — | 0.4 | — | 0.4 | — | 0.4 | — | 0.5 | — | ns | 1 |
| Control Input Setup Time (\overline{R} , \overline{W}) | t_{IVKH} | 0.4 | — | 0.4 | — | 0.4 | — | 0.4 | — | 0.5 | — | ns | 2 |
| Control Input Setup Time ($\overline{BW\overline{X}}$, ($\overline{BW\overline{X}}$) | t_{IVKH} | 0.28 | — | 0.28 | — | 0.28 | — | 0.3 | — | 0.35 | — | ns | 3 |
| Data Input Setup Time | t_{DVKH} | 0.28 | — | 0.28 | — | 0.28 | — | 0.3 | — | 0.35 | — | ns | |
| Hold Times | | | | | | | | | | | | | |
| Address Input Hold Time | t_{KHAX} | 0.4 | — | 0.4 | — | 0.4 | — | 0.4 | — | 0.5 | — | ns | 1 |
| Control Input Hold Time (\overline{R} , \overline{W}) | t_{KHIX} | 0.4 | — | 0.4 | — | 0.4 | — | 0.4 | — | 0.5 | — | ns | 2 |
| Control Input Hold Time ($\overline{BW\overline{X}}$, ($\overline{BW\overline{X}}$) | t_{KHIX} | 0.28 | — | 0.28 | — | 0.28 | — | 0.3 | — | 0.35 | — | ns | 3 |
| Data Input Hold Time | t_{KHDX} | 0.28 | — | 0.28 | — | 0.28 | — | 0.3 | — | 0.35 | — | ns | |

Notes:

1. All Address inputs must meet the specified setup and hold times for all latching clock edges.
2. Control signals are \overline{R} , \overline{W} .
3. Control signals are $\overline{BW0}$, $\overline{BW1}$ (and $\overline{BW2}$, $\overline{BW3}$ for x36).
4. If \overline{C} , \overline{C} are tied high, \overline{K} , \overline{K} become the references for \overline{C} , \overline{C} timing parameters.
5. To avoid bus contention, at a given voltage and temperature t_{CHQX1} is bigger than t_{CHQZ} . The specs as shown do not imply bus contention because t_{CHQX1} is a MIN parameter that is worst case at totally different test conditions (0°C, 1.9 V) than t_{CHQZ} , which is a MAX parameter (worst case at 70°C, 1.7 V). It is not possible for two SRAMs on the same board to be at such different voltages and temperatures.
6. Clock phase jitter is the variance from clock rising edge to the next expected clock rising edge.
7. V_{DD} slew rate must be less than 0.1 V DC per 50 ns for DLL lock retention. DLL lock time begins once V_{DD} and input clock are stable.
8. Echo clock is very tightly controlled to data valid/data hold. By design, there is a ± 0.1 ns variation from echo clock to data. The datasheet parameters reflect tester guard bands and test setup variations.
9. After device power-up, 20 μ s of stable input clocks (as specified by t_{Kini}) must be supplied before reads and writes are issued.

K and \bar{K} Controlled Read-Write-Read Timing Diagram

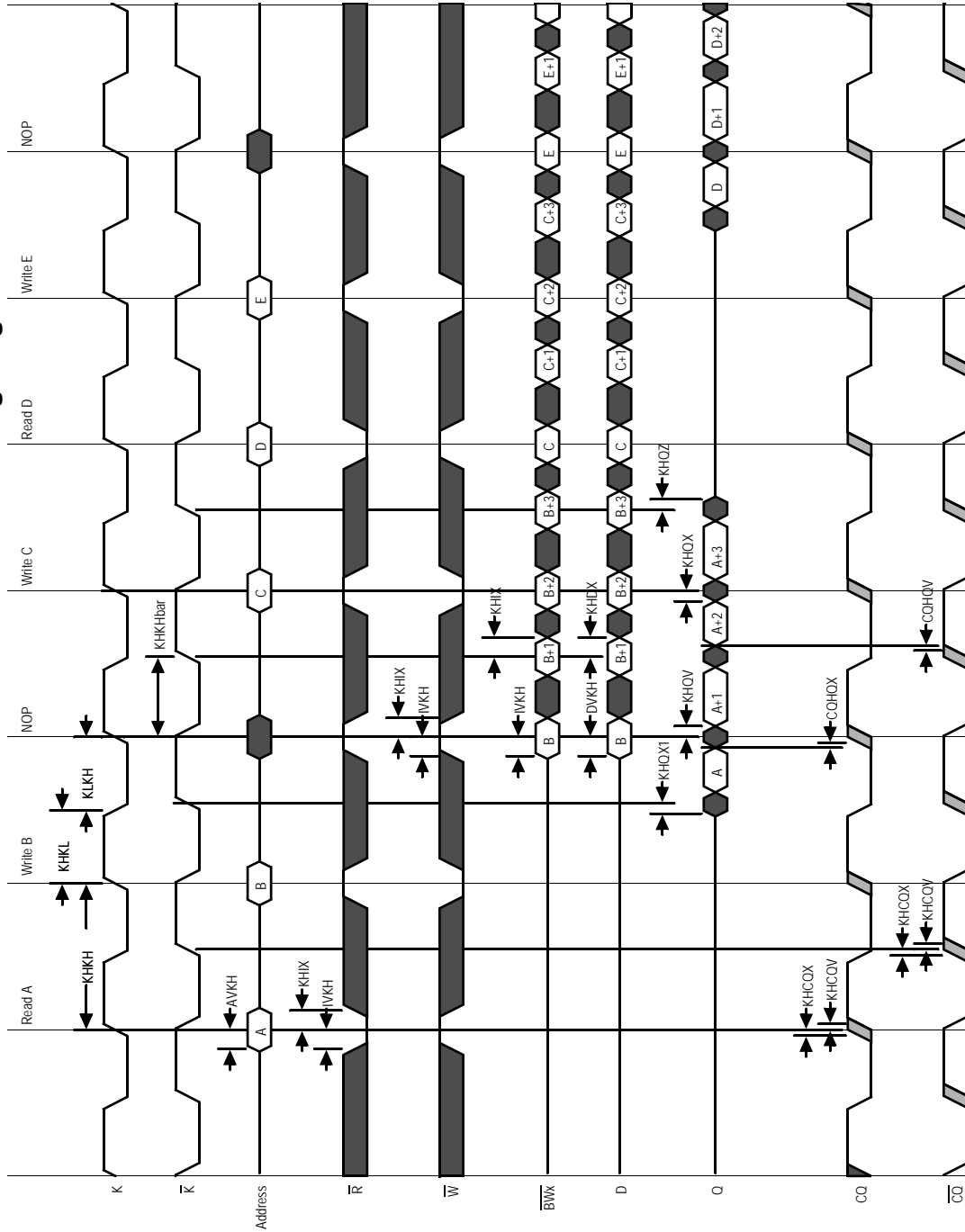

C and C Controlled Read-Write-Read Timing Diagram

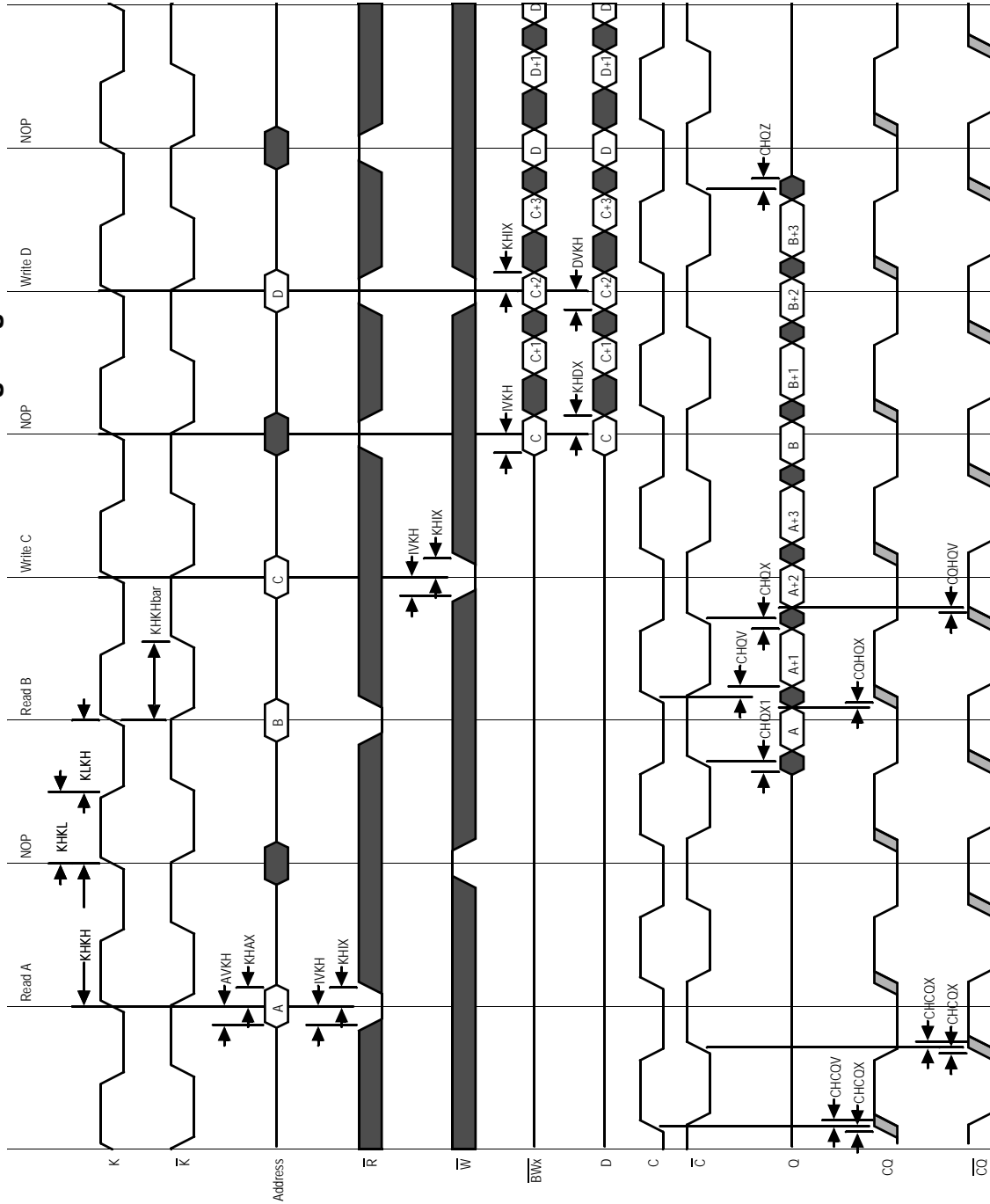

JTAG Port Operation

Overview

The JTAG Port on this RAM operates in a manner that is compliant with IEEE Standard 1149.1-1990, a serial boundary scan interface standard (commonly referred to as JTAG). The JTAG Port input interface levels scale with V_{DD} . The JTAG output drivers are powered by V_{DD} .

Disabling the JTAG Port

It is possible to use this device without utilizing the JTAG port. The port is reset at power-up and will remain inactive unless clocked. TCK, TDI, and TMS are designed with internal pull-up circuits. To assure normal operation of the RAM with the JTAG Port unused, TCK, TDI, and TMS may be left floating or tied to either V_{DD} or V_{SS} . TDO should be left unconnected.

JTAG Pin Descriptions

| Pin | Pin Name | I/O | Description |
|-----|------------------|-----|--|
| TCK | Test Clock | In | Clocks all TAP events. All inputs are captured on the rising edge of TCK and all outputs propagate from the falling edge of TCK. |
| TMS | Test Mode Select | In | The TMS input is sampled on the rising edge of TCK. This is the command input for the TAP controller state machine. An undriven TMS input will produce the same result as a logic one input level. |
| TDI | Test Data In | In | The TDI input is sampled on the rising edge of TCK. This is the input side of the serial registers placed between TDI and TDO. The register placed between TDI and TDO is determined by the state of the TAP Controller state machine and the instruction that is currently loaded in the TAP Instruction Register (refer to the TAP Controller State Diagram). An undriven TDI pin will produce the same result as a logic one input level. |
| TDO | Test Data Out | Out | Output that is active depending on the state of the TAP state machine. Output changes in response to the falling edge of TCK. This is the output side of the serial registers placed between TDI and TDO. |

Note:

This device does not have a TRST (TAP Reset) pin. TRST is optional in IEEE 1149.1. The Test-Logic-Reset state is entered while TMS is held high for five rising edges of TCK. The TAP Controller is also reset automatically at power-up.

JTAG Port Registers

Overview

The various JTAG registers, referred to as Test Access Port or TAP Registers, are selected (one at a time) via the sequences of 1s and 0s applied to TMS as TCK is strobed. Each of the TAP Registers is a serial shift register that captures serial input data on the rising edge of TCK and pushes serial data out on the next falling edge of TCK. When a register is selected, it is placed between the TDI and TDO pins.

Instruction Register

The Instruction Register holds the instructions that are executed by the TAP controller when it is moved into the Run, Test/Idle, or the various data register states. Instructions are 3 bits long. The Instruction Register can be loaded when it is placed between the TDI and TDO pins. The Instruction Register is automatically preloaded with the IDCODE instruction at power-up or whenever the controller is placed in Test-Logic-Reset state.

Bypass Register

The Bypass Register is a single bit register that can be placed between TDI and TDO. It allows serial test data to be passed through the RAM's JTAG Port to another device in the scan chain with as little delay as possible.

Boundary Scan Register

The Boundary Scan Register is a collection of flip flops that can be preset by the logic level found on the RAM's input or I/O pins. The flip flops are then daisy chained together so the levels found can be shifted serially out of the JTAG Port's TDO pin. The Boundary Scan Register also includes a number of place holder flip flops (always set to a logic 1). The relationship between the device pins and the bits in the Boundary Scan Register is described in the Scan Order Table following. The Boundary Scan Register, under the control of the TAP Controller, is loaded with the contents of the RAMs I/O ring when the controller is in Capture-DR state and then is placed between the TDI and TDO pins when the controller is moved to Shift-DR state. SAMPLE-Z, SAMPLE/PRELOAD and EXTEST instructions can be used to activate the Boundary Scan Register.

JTAG TAP Block Diagram

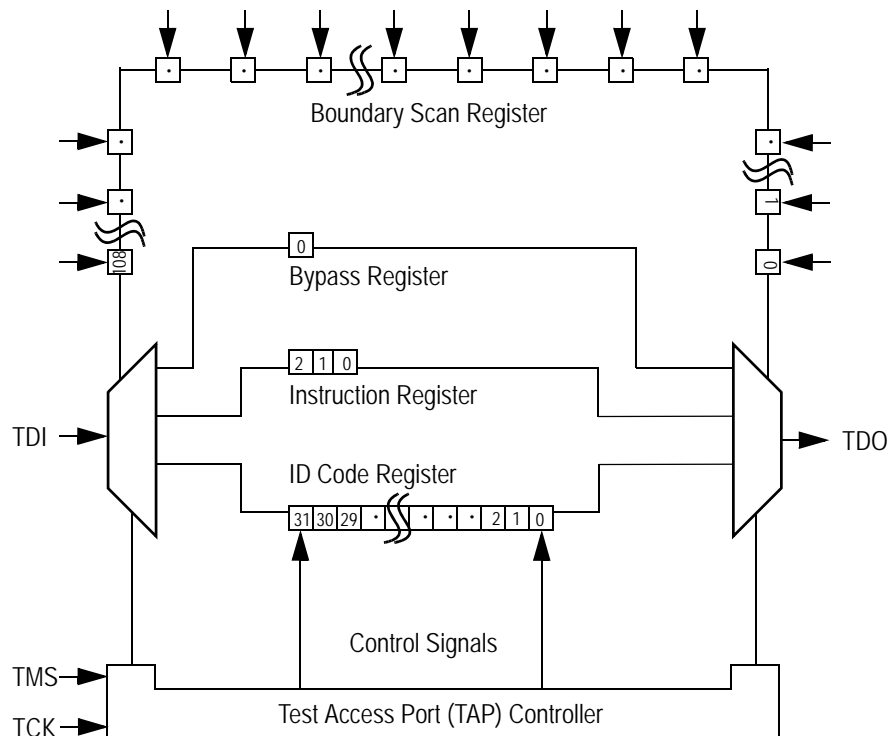

Identification (ID) Register

The ID Register is a 32-bit register that is loaded with a device and vendor specific 32-bit code when the controller is put in Capture-DR state with the IDCODE command loaded in the Instruction Register. The code is loaded from a 32-bit on-chip ROM. It describes various attributes of the RAM as indicated below. The register is then placed between the TDI and TDO pins when the controller is moved into Shift-DR state. Bit 0 in the register is the LSB and the first to reach TDO when shifting begins.

ID Register Contents

| See BSDL Model | | | | | | | | | | | | | | | | | | GSI Technology JEDEC Vendor ID Code | | | | | | | | Presence Register | | | | | | |
|----------------|----|----|----|----|----|----|----|----|----|----|----|----|----|----|----|----|----|---|----|----|----|----|---|---|---|-------------------|---|---|---|---|---|---|
| Bit # | 31 | 30 | 29 | 28 | 27 | 26 | 25 | 24 | 23 | 22 | 21 | 20 | 19 | 18 | 17 | 16 | 15 | 14 | 13 | 12 | 11 | 10 | 9 | 8 | 7 | 6 | 5 | 4 | 3 | 2 | 1 | 0 |
| | X | X | X | X | X | X | X | X | X | X | X | X | X | X | X | X | X | X | X | X | 0 | 0 | 0 | 1 | 1 | 0 | 1 | 1 | 0 | 0 | 1 | 1 |

Tap Controller Instruction Set

Overview

There are two classes of instructions defined in the Standard 1149.1-1990; the standard (Public) instructions, and device specific (Private) instructions. Some Public instructions are mandatory for 1149.1 compliance. Optional Public instructions must be implemented in prescribed ways. The TAP on this device may be used to monitor all input and I/O pads, and can be used to load address, data or control signals into the RAM or to preload the I/O buffers.

When the TAP controller is placed in Capture-IR state the two least significant bits of the instruction register are loaded with 01. When the controller is moved to the Shift-IR state the Instruction Register is placed between TDI and TDO. In this state the desired instruction is serially loaded through the TDI input (while the previous contents are shifted out at TDO). For all instructions, the TAP executes newly loaded instructions only when the controller is moved to Update-IR state. The TAP instruction set for this device is listed in the following table.

JTAG Tap Controller State Diagram

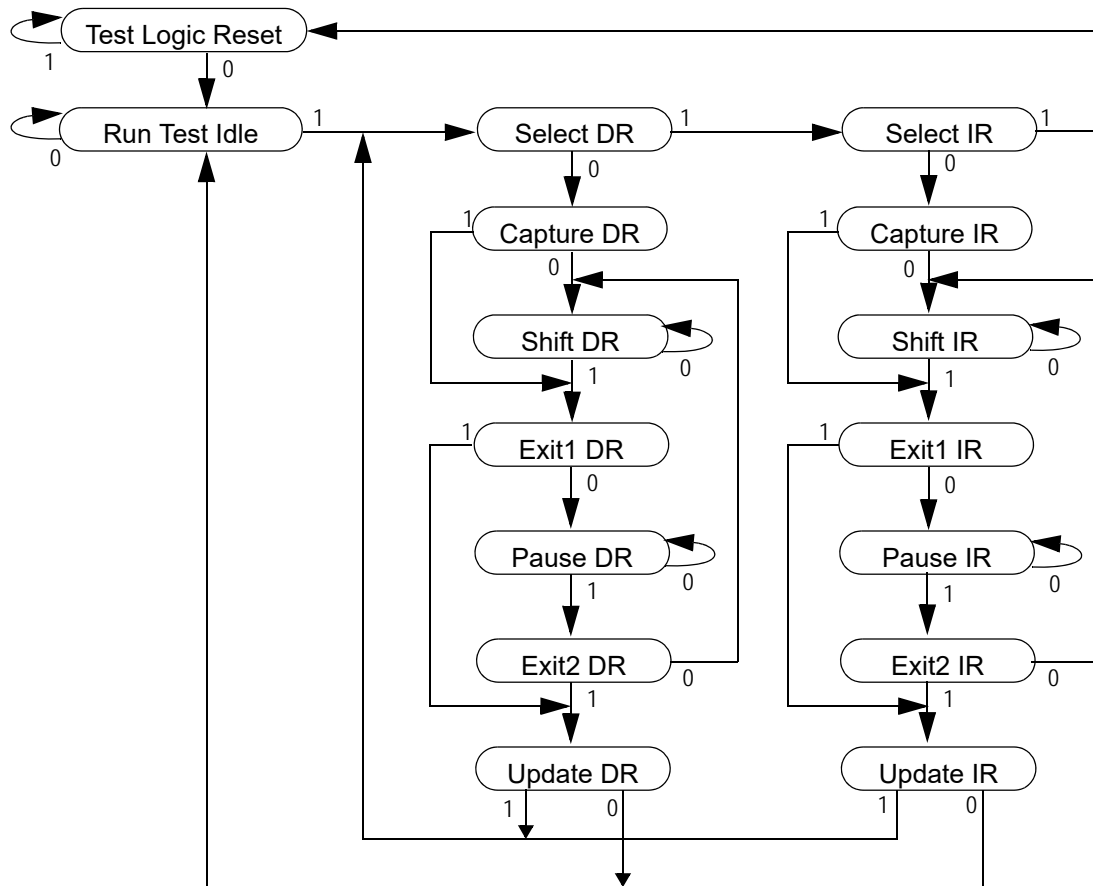

Instruction Descriptions

BYPASS

When the BYPASS instruction is loaded in the Instruction Register the Bypass Register is placed between TDI and TDO. This occurs when the TAP controller is moved to the Shift-DR state. This allows the board level scan path to be shortened to facilitate testing of other devices in the scan path.

SAMPLE/PRELOAD

SAMPLE/PRELOAD is a Standard 1149.1 mandatory public instruction. When the SAMPLE / PRELOAD instruction is loaded in the Instruction Register, moving the TAP controller into the Capture-DR state loads the data in the RAMs input and I/O buffers into the Boundary Scan Register. Boundary Scan Register locations are not associated with an input or I/O pin, and are loaded with the default state identified in the Boundary Scan Chain table at the end of this section of the datasheet. Because the RAM clock is independent from the TAP Clock (TCK) it is possible for the TAP to attempt to capture the I/O ring contents while the input buffers are in transition (i.e. in a metastable state). Although allowing the TAP to sample metastable inputs will not harm the device, repeatable results cannot be expected. RAM input signals must be stabilized for long enough to meet the TAPs input data capture set-up plus hold time (t_{TS} plus t_{TH}). The RAMs clock inputs need not be paused for any other TAP operation except capturing the I/O ring contents into the Boundary Scan Register. Moving the controller to Shift-DR state then places the boundary scan register between the TDI and TDO pins.

EXTEST

EXTEST is an IEEE 1149.1 mandatory public instruction. It is to be executed whenever the instruction register is loaded with all logic 0s. The EXTEST command does not block or override the RAM's input pins; therefore, the RAM's internal state is still determined by its input pins.

Typically, the Boundary Scan Register is loaded with the desired pattern of data with the SAMPLE/PRELOAD command. Then the EXTEST command is used to output the Boundary Scan Register's contents, in parallel, on the RAM's data output drivers on the falling edge of TCK when the controller is in the Update-IR state.

Alternately, the Boundary Scan Register may be loaded in parallel using the EXTEST command. When the EXTEST instruction is selected, the state of all the RAM's input and I/O pins, as well as the default values at Scan Register locations not associated with a pin, are transferred in parallel into the Boundary Scan Register on the rising edge of TCK in the Capture-DR state, the RAM's output pins drive out the value of the Boundary Scan Register location with which each output pin is associated.

IDCODE

The IDCODE instruction causes the ID ROM to be loaded into the ID register when the controller is in Capture-DR mode and places the ID register between the TDI and TDO pins in Shift-DR mode. The IDCODE instruction is the default instruction loaded in at power up and any time the controller is placed in the Test-Logic-Reset state.

SAMPLE-Z

If the SAMPLE-Z instruction is loaded in the instruction register, all RAM outputs are forced to an inactive drive state (high-Z) and the Boundary Scan Register is connected between TDI and TDO when the TAP controller is moved to the Shift-DR state.

JTAG TAP Instruction Set Summary

| Instruction | Code | Description | Notes |
|----------------|------|---|-------|
| EXTEST | 000 | Places the Boundary Scan Register between TDI and TDO. | 1 |
| IDCODE | 001 | Preloads ID Register and places it between TDI and TDO. | 1, 2 |
| SAMPLE-Z | 010 | Captures I/O ring contents. Places the Boundary Scan Register between TDI and TDO. Forces all RAM output drivers to High-Z. | 1 |
| GSI | 011 | GSI private instruction. | 1 |
| SAMPLE/PRELOAD | 100 | Captures I/O ring contents. Places the Boundary Scan Register between TDI and TDO. | 1 |
| GSI | 101 | GSI private instruction. | 1 |
| GSI | 110 | GSI private instruction. | 1 |
| BYPASS | 111 | Places Bypass Register between TDI and TDO. | 1 |

Notes:

1. Instruction codes expressed in binary, MSB on left, LSB on right.
2. Default instruction automatically loaded at power-up and in test-logic-reset state.

JTAG Port Recommended Operating Conditions and DC Characteristics

| Parameter | Symbol | Min. | Max. | Unit | Notes |
|--|------------|----------------|----------------|------|-------|
| Test Port Input Low Voltage | V_{ILJ} | -0.3 | $0.3 * V_{DD}$ | V | 1 |
| Test Port Input High Voltage | V_{IHJ} | $0.7 * V_{DD}$ | $V_{DD} + 0.3$ | V | 1 |
| TMS, TCK and TDI Input Leakage Current | I_{INHJ} | -300 | 1 | uA | 2 |
| TMS, TCK and TDI Input Leakage Current | I_{INLJ} | -1 | 100 | uA | 3 |
| TDO Output Leakage Current | I_{OLJ} | -1 | 1 | uA | 4 |
| Test Port Output High Voltage | V_{OHJ} | $V_{DD} - 0.2$ | — | V | 5, 6 |
| Test Port Output Low Voltage | V_{OLJ} | — | 0.2 | V | 5, 7 |
| Test Port Output CMOS High | V_{OHJC} | $V_{DD} - 0.1$ | — | V | 5, 8 |
| Test Port Output CMOS Low | V_{OLJC} | — | 0.1 | V | 5, 9 |

Notes:

- Input Under/overshoot voltage must be $-1\text{ V} < V_i < V_{DDn} + 1\text{ V}$ not to exceed 2.9 V maximum, with a pulse width not to exceed 20% tTKC.
- $V_{ILJ} \leq V_{IN} \leq V_{DDn}$
- $0\text{ V} \leq V_{IN} \leq V_{ILJn}$
- Output Disable, $V_{OUT} = 0$ to V_{DDn}
- The TDO output driver is served by the V_{DD} supply.
- $I_{OHJ} = -2\text{ mA}$
- $I_{OLJ} = +2\text{ mA}$
- $I_{OHJC} = -100\text{ uA}$
- $I_{OLJC} = +100\text{ uA}$

JTAG Port AC Test Conditions

| Parameter | Conditions |
|------------------------|-------------------------|
| Input high level | $V_{DD} - 0.2\text{ V}$ |
| Input low level | 0.2 V |
| Input slew rate | 1 V/ns |
| Input reference level | $V_{DD}/2$ |
| Output reference level | $V_{DD}/2$ |

Notes:

- Include scope and jig capacitance.
- Test conditions as shown unless otherwise noted.

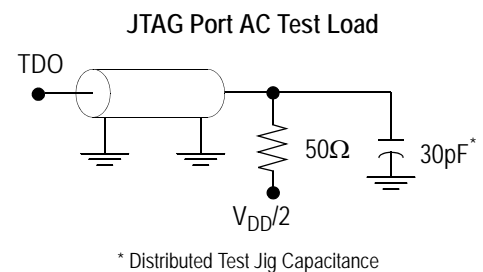

JTAG Port Timing Diagram

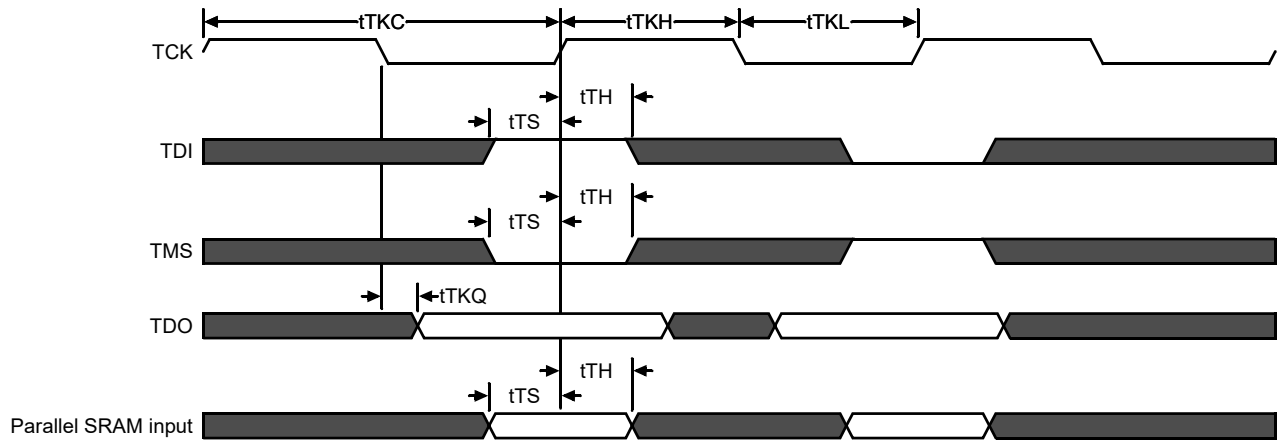

JTAG Port AC Electrical Characteristics

| Parameter | Symbol | Min | Max | Unit |
|-----------------------|-----------|-----|-----|------|
| TCK Cycle Time | t_{TKC} | 50 | — | ns |
| TCK Low to TDO Valid | t_{TKQ} | — | 20 | ns |
| TCK High Pulse Width | t_{TKH} | 20 | — | ns |
| TCK Low Pulse Width | t_{TKL} | 20 | — | ns |
| TDI & TMS Set Up Time | t_{TS} | 10 | — | ns |
| TDI & TMS Hold Time | t_{TH} | 10 | — | ns |

Package Dimensions—165-Bump FPBGA (Package GE)

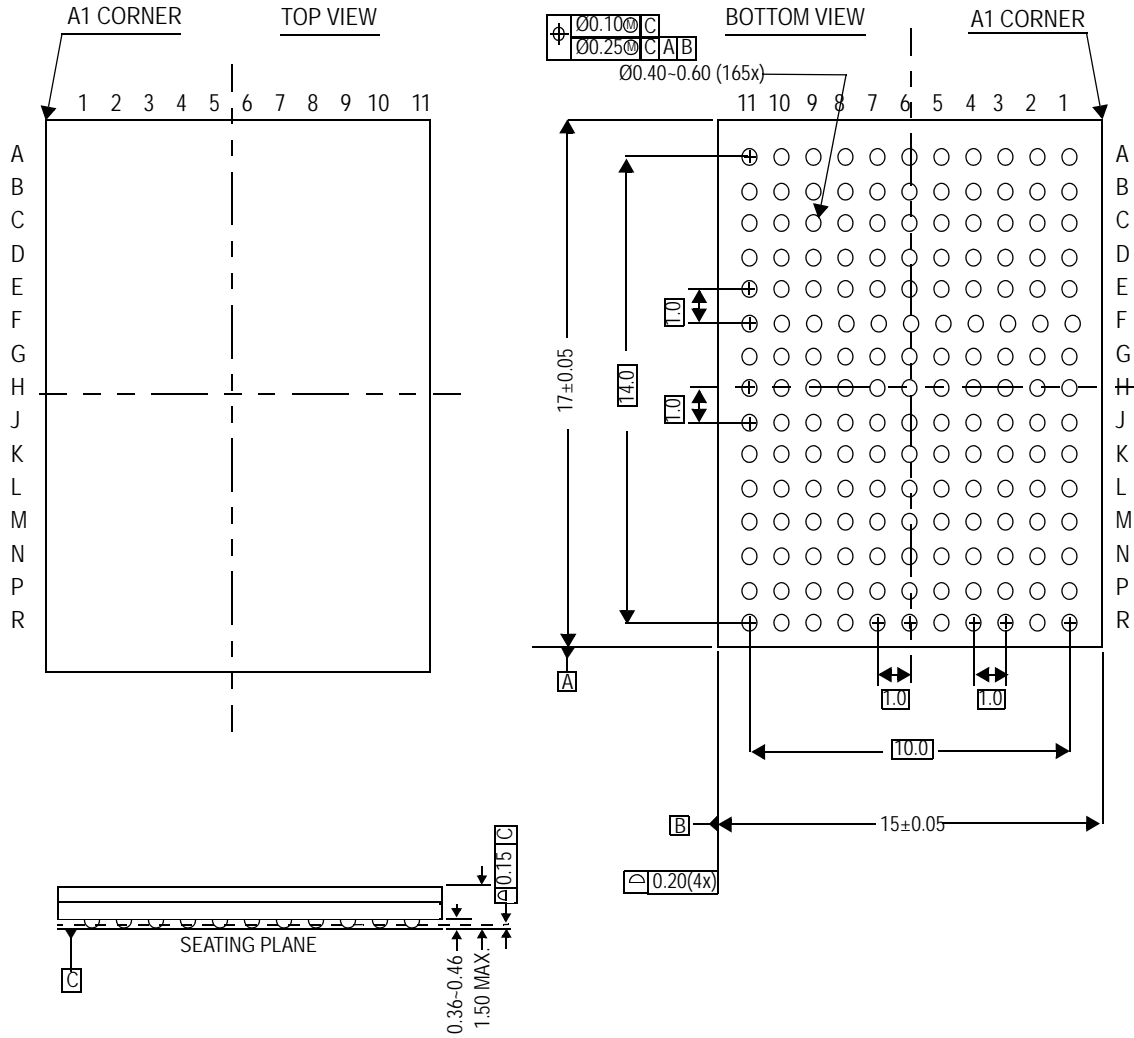

Ordering Information—GSI SigmaQuad-II SRAM

| Org | Part Number1 | Type | Package | Speed (MHz) | T _J ² |
|----------|-------------------|-------------------|-----------------------------|-------------|-----------------------------|
| 16M x 18 | GS82582D18GE-400 | SigmaQuad-II SRAM | RoHS-compliant 165-bump BGA | 400 | C |
| 16M x 18 | GS82582D18GE-375 | SigmaQuad-II SRAM | RoHS-compliant 165-bump BGA | 375 | C |
| 16M x 18 | GS82582D18GE-333 | SigmaQuad-II SRAM | RoHS-compliant 165-bump BGA | 333 | C |
| 16M x 18 | GS82582D18GE-300 | SigmaQuad-II SRAM | RoHS-compliant 165-bump BGA | 300 | C |
| 16M x 18 | GS82582D18GE-250 | SigmaQuad-II SRAM | RoHS-compliant 165-bump BGA | 250 | C |
| 16M x 18 | GS82582D18GE-400I | SigmaQuad-II SRAM | RoHS-compliant 165-bump BGA | 400 | I |
| 16M x 18 | GS82582D18GE-375I | SigmaQuad-II SRAM | RoHS-compliant 165-bump BGA | 375 | I |
| 16M x 18 | GS82582D18GE-333I | SigmaQuad-II SRAM | RoHS-compliant 165-bump BGA | 333 | I |
| 16M x 18 | GS82582D18GE-300I | SigmaQuad-II SRAM | RoHS-compliant 165-bump BGA | 300 | I |
| 16M x 18 | GS82582D18GE-250I | SigmaQuad-II SRAM | RoHS-compliant 165-bump BGA | 250 | I |
| 8M x 36 | GS82582D36GE-400 | SigmaQuad-II SRAM | RoHS-compliant 165-bump BGA | 400 | C |
| 8M x 36 | GS82582D36GE-375 | SigmaQuad-II SRAM | RoHS-compliant 165-bump BGA | 375 | C |
| 8M x 36 | GS82582D36GE-333 | SigmaQuad-II SRAM | RoHS-compliant 165-bump BGA | 333 | C |
| 8M x 36 | GS82582D36GE-300 | SigmaQuad-II SRAM | RoHS-compliant 165-bump BGA | 300 | C |
| 8M x 36 | GS82582D36GE-250 | SigmaQuad-II SRAM | RoHS-compliant 165-bump BGA | 250 | C |
| 8M x 36 | GS82582D36GE-400I | SigmaQuad-II SRAM | RoHS-compliant 165-bump BGA | 400 | I |
| 8M x 36 | GS82582D36GE-375I | SigmaQuad-II SRAM | RoHS-compliant 165-bump BGA | 375 | I |
| 8M x 36 | GS82582D36GE-333I | SigmaQuad-II SRAM | RoHS-compliant 165-bump BGA | 333 | I |
| 8M x 36 | GS82582D36GE-300I | SigmaQuad-II SRAM | RoHS-compliant 165-bump BGA | 300 | I |
| 8M x 36 | GS82582D36GE-250I | SigmaQuad-II SRAM | RoHS-compliant 165-bump BGA | 250 | I |

Notes:

- Customers requiring delivery in Tape and Reel should add the character "T" to the end of the part number.
Example: GS82582D36GE-300T.
- C = Commercial Temperature Range. I = Industrial Temperature Range.

SigmaQuad-II Revision History

| File Name | Format/Content | Description of changes |
|----------------|----------------|---|
| 82582Dxx_r1 | | Creation of datasheet |
| 82582Dxx_r1_01 | Content | Updated speed bin offerings |
| 82582Dxx_r1_02 | Content | Removed x8 and x9 configurations |
| 82582Dxx_r1_03 | Content | <ul style="list-style-type: none">• Removed leaded part numbers• Added Power-Up Initialization section on page 10• Added tKInit specification |
| 82582Dxx_r1_04 | Content | <ul style="list-style-type: none">• Removed Preliminary banner• Added Op Current CZ data |



Стандарт Электрон Связь

Мы молодая и активно развивающаяся компания в области поставок электронных компонентов. Мы поставляем электронные компоненты отечественного и импортного производства напрямую от производителей и с крупнейших складов мира.

Благодаря сотрудничеству с мировыми поставщиками мы осуществляем комплексные и плановые поставки широчайшего спектра электронных компонентов.

Собственная эффективная логистика и склад в обеспечивает надежную поставку продукции в точно указанные сроки по всей России.

Мы осуществляем техническую поддержку нашим клиентам и предпродажную проверку качества продукции. На все поставляемые продукты мы предоставляем гарантию .

Осуществляем поставки продукции под контролем ВП МО РФ на предприятия военно-промышленного комплекса России , а также работаем в рамках 275 ФЗ с открытием отдельных счетов в уполномоченном банке. Система менеджмента качества компании соответствует требованиям ГОСТ ISO 9001.

Минимальные сроки поставки, гибкие цены, неограниченный ассортимент и индивидуальный подход к клиентам являются основой для выстраивания долгосрочного и эффективного сотрудничества с предприятиями радиоэлектронной промышленности, предприятиями ВПК и научно-исследовательскими институтами России.

С нами вы становитесь еще успешнее!

Наши контакты:

Телефон: +7 812 627 14 35

Электронная почта: sales@st-electron.ru

Адрес: 198099, Санкт-Петербург,
Промышленная ул, дом № 19, литера Н,
помещение 100-Н Офис 331