**ATA6621, ATA6621N, ATA6622, ATA6622C, ATA6624,
ATA6624C, ATA6626, ATA6626C Development Board**

ATA6621/22/24/26

Introduction

The development board for the Atmel® ATA6621/22/24/26 (ATA6621-EK, ATA6622-EK, ATA6624-EK, ATA6626-EK) is designed to give designers a quick start with the ICs and for prototyping and testing of new LIN designs.

The Atmel ATA6621, Atmel ATA6622, Atmel ATA6624 and Atmel ATA6626 are system basis chips (SBCs) with fully integrated LIN transceiver, window watchdog with adjustable trigger times and low-drop voltage regulator providing 5V/85mA (3.3V/85mA for the Atmel ATA6622). The output current of the regulator can be boosted by using an external NPN transistor.

The Atmel ATA6622 and the Atmel ATA6624 are totally pin- and function-compatible, the only difference between these circuits is the regulator's output voltage.

The ATA6626 has the same functionality as the ATA6624 without TXD time-out timer. The ATA6626 is able to switch the LIN pin without any time limitation to dominant level via the TXD input and is therefore particularly suited for low data rates.

The Atmel ATA6621 differs in a few more ways — an initial overview of these differences starts with the different pins listed in [Table 1](#).

Table 1. Overview of Pin Differences

Pin No.	Atmel ATA6621	ATA6622/24/26
2	PTRIG	GND
6	Not connected	GND
8	Not connected	GND
10	Not connected	INH
16	GND	KL_15
17	TEMP	GND

Figure 1. ATA6621/22/24/26 Development Board

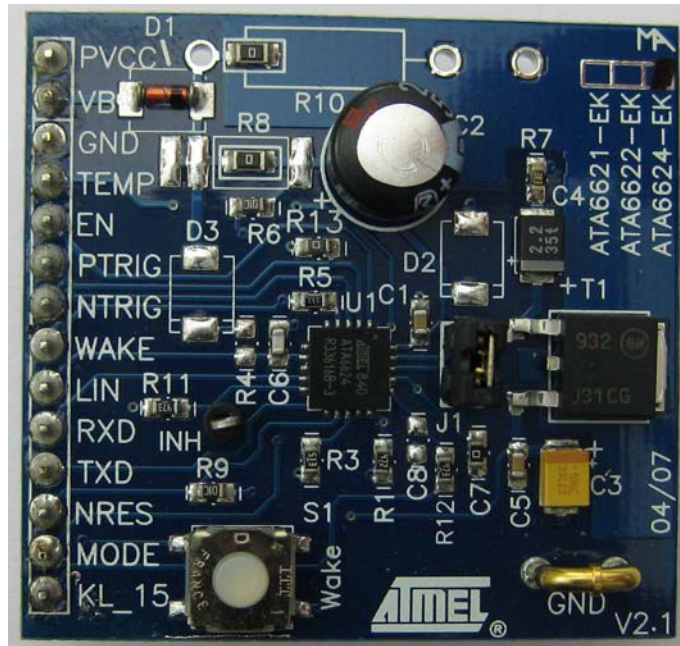

Another difference is unequal watchdog timing (see [Section 1.3 on page 4](#)).

The combination of the features included in the Atmel® ATA6621/22/24/26 makes it possible to develop simple, but powerful and cheap, slave nodes in LIN-bus systems.

The ICs are designed to handle the low-speed data communication in vehicles, for example, in convenience electronics. Improved slope control at the LIN driver ensures secure data communication up to 20Kbaud.

Sleep Mode and Silent Mode guarantee a very low current consumption.

This document has been developed to give the user an easy start with the development board of the Atmel ATA6621/22/24/26. For more detailed information about the use of these devices themselves, refer to the corresponding datasheets.

Development Board Features

The development board for the Atmel ATA6621/22/24/26 supports the following features:

- All necessary components to put the Atmel ATA6621/22/24/26 in operation are included
- Placeholders for some optional components for extended functions included
- All pins easily accessible
- Easily adaptable watchdog times by replacing a resistor
- Possibility to place an external NPN transistor for boosting up the output current of the voltage regulator (jumper J1)
- Possibility of selecting between master or slave operation (mounting D3 and R4)

Quick Start

The development board for the Atmel ATA6621/22/24/26 is shipped with all necessary components and a default jumper setting to start with the development of a LIN slave node immediately.

After connecting an external 12V DC power supply between the terminals VB and GND, the circuit is in the Pre-normal mode (Fail-safe mode) and a 5V (3.3V) DC voltage provided by the internal voltage regulator can be measured between VCC and GND. (The Pre-normal mode is called Fail-safe mode in the datasheets of the devices Atmel ATA6622/24/26). Furthermore, the following voltages or states can be measured at the pins WD_OSC, TEMP, INH, RXD and LIN:

Table 2. Atmel ATA6621

Mode	VCC	WD_OSC	TEMP	INH	RXD	LIN	Transceiver
Pre-normal mode	5V	2.5V	~2V	-	5V	Recessive	Off
Normal mode	5V	2.5V	~2V	-	5V	TXD dependent	On

Table 3. Atmel ATA6622

Mode	VCC	WD_OSC	TEMP	INH	RXD	LIN	Transceiver
Fail-safe mode	3.3V	1.23V	-	On	3.3V	Recessive	Off
Normal mode	3.3V	1.23V	-	On	3.3V	TXD dependent	On

Table 4. Atmel ATA6624/26

Mode	VCC	WD_OSC	TEMP	INH	RXD	LIN	Transceiver
Fail-safe mode	5V	1.23V	-	On	5V	Recessive	Off
Normal mode	5V	1.23V	-	On	5V	TXD dependent	On

As the window watchdog of the Atmel[®] ATA6621/22/24/26 is already active in the Pre-normal mode (Fail-safe mode), a periodic reset signal will be generated at the pin NRES as long as no trigger signal can be received at the watchdog trigger input. Normally the connected microcontroller will be monitored by the watchdog, so it has to generate the required trigger signal as described in [Section 1.3 on page 4](#) and in more detail in the datasheet of the corresponding device. For the quick start it is sufficient to generate a square-wave signal with $V_{PP} = VCC$ and $f = 75\text{Hz}$ at pin NTRIG or PTRIG for the Atmel ATA6621 or with $f = 50\text{Hz}$ at pin NTRIG for the Atmel ATA6622/24/26 (this is recommended only for testing purposes). In order to check that the watchdog is triggered in the expected way, the reset pin NRES can be monitored until a continuous high level is available.

Please note that the communication is still inactive in Pre-normal mode (Fail-safe mode).

In order to communicate via the LIN bus interface you have to switch to normal mode by applying the VCC voltage (5V or 3.3V, as appropriate) at pin EN.

1. Hardware Description

In the following sections only the normal operating conditions will be described. For further information concerning one of the mentioned features, refer to the corresponding datasheet.

1.1 Power Supply (VB and GND)

In order to get the development board running, an external 5.7V to 18V DC power supply is required between the terminals VB and GND. The input circuit is protected against inverse-polarity with the protection diode D1, so that there is normally a difference between the VB and VS level of approximately 0.7V.

1.2 Voltage Regulator (PVCC and VCC)

The internal 5V/3.3V voltage regulator is capable of driving loads up to 85mA so the SBCs are able to supply a microcontroller, sensors and/or other ICs. The voltage regulator is protected against overloads by means of current limitation and overtemperature shutdown. To boost the maximum load current, an external NPN transistor may be used, with its base being connected to the VCC pin and its emitter connected to PVCC. If this is done, the regulated output voltage of 5V or 3.3V is available at pin PVCC. For this reason, the pin PVCC and not the pin VCC is led to the connector available off the board. But in normal operation, the pins PVCC and VCC have to be connected directly. This is done by setting jumper J1.

1.3 The Window Watchdog (PTRIG, NTRIG and NRES)

The watchdog anticipates a trigger signal from the microcontroller at the NTRIG input (negative edge) within a defined time window. The Atmel ATA6621 has an additional PTRIG input, so it is also possible to trigger the watchdog with a positive edge. If no correct trigger signal is received, a reset signal will be generated at the NRES output. During Silent or Sleep Mode the watchdog is switched off to reduce current consumption.

The minimum time for the first watchdog pulse is required after the undervoltage reset at the NRES pin disappears and is defined as lead time t_d .

The timing basis of the watchdog is provided by the internal oscillator, whose time period t_{OSC} is adjustable via the external resistor R3 at the pin WD_OSC. For the Atmel ATA6621, the voltage at this pin is 2.5V, for the Atmel ATA6622/24/26 it is 1.23V (see [Table 2 on page 3](#) through [Table 4 on page 3](#)). Due to these different voltages at the devices, the resulting timings are also different. There is a resistor R3 with a value of 51k Ω mounted on the development board, which results in the following timing sequence for the Atmel ATA6621:

Figure 1-1. Timing Sequence with R3 = 51k Ω at the Atmel ATA6621

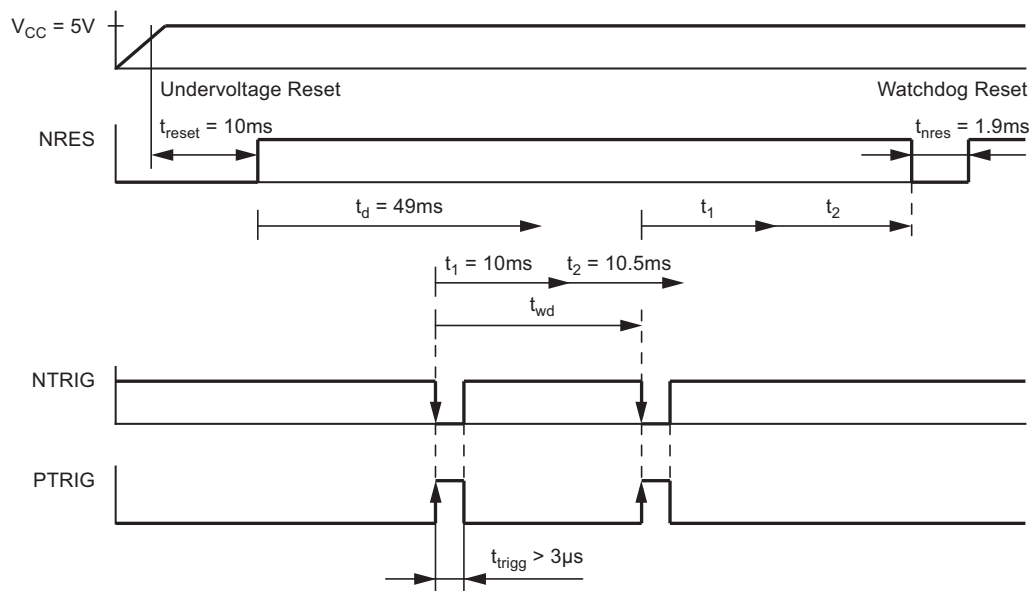

For the Atmel® ATA6622/24/26 the resistor R3 at pin WD_OSC with the same value of 51kΩ results in the different timing sequence shown in Figure 1-2:

Figure 1-2. Timing Sequence with R3 = 51kΩ at the Atmel ATA6622/24/26

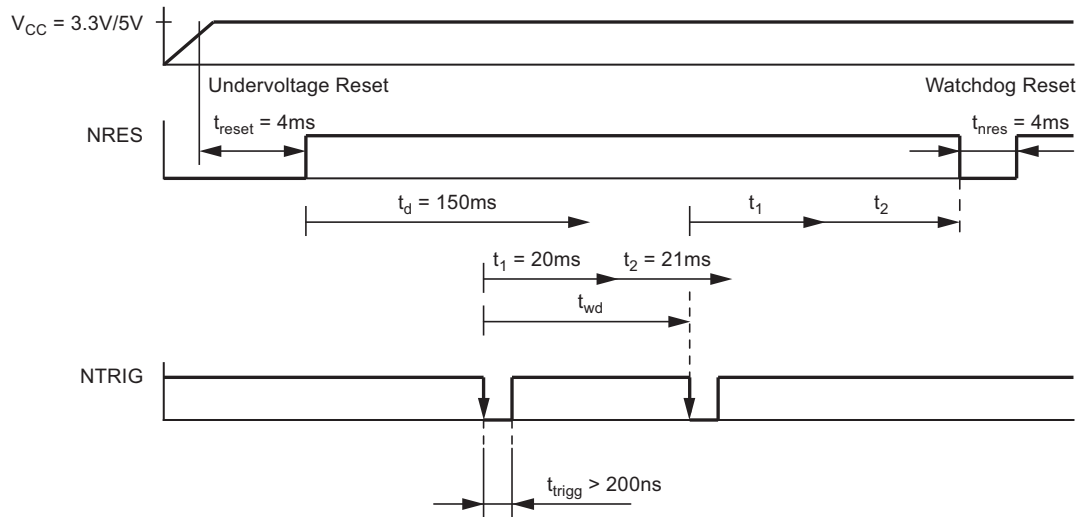

If you want to change the watchdog times mentioned above it is only necessary to change the value of the external resistor R3 (refer to the corresponding datasheet).

1.4 LIN Interface (LIN, TXD and RXD)

1.4.1 Bus Pin (LIN)

A low-side driver with internal current limitation and thermal shutdown as well as an internal pull-up resistor in compliance with the LIN specification 2.0 is implemented. LIN receiver thresholds are compatible with the LIN protocol specification.

At the LIN pin there is a 220-pF capacitor to ground on the board. Additionally, when using the development board for a LIN master application, there is the opportunity to mount the two necessary extra components diode D2 (LL4148) in series with resistor R1 (1kΩ) on the board at their designated placeholders.

1.4.2 Input Pin (TXD)

In Normal Mode this pin is the microcontroller interface to control the state of the LIN output. TXD must be pulled to ground in order to have the LIN bus low. If TXD is high, the LIN output transistor is turned off and the bus is in the recessive state, pulled up by the internal resistor. If TXD is low, the LIN output transistor is turned on and the bus is in the dominant state.

An internal timer prevents the bus line from being driven permanently in the dominant state. If TXD is forced to low longer than t_{DOM} > 20ms, the LIN bus driver is switched to the recessive state. This time-out function is disabled in the Atmel ATA6626.

1.4.3 Output Pin (RXD)

This pin reports the state of the LIN bus to the microcontroller. LIN high (recessive state) is reported by a high level at RXD, LIN low (dominant state) is reported by a low level at RXD. The output has an internal pull-up resistor with typ. 5kΩ to V_{CC}. The output is short-circuit protected.

1.5 Temp Pin (TEMP) (Atmel ATA6621 Only)

Besides the internal temperature monitoring of the voltage regulator, an additional sensor measures the junction temperature and provides a linearized voltage at the TEMP pin. Together with the analog functions of the microcontroller (for example, the analog comparator and/or the analog-to-digital converter), this enables the application to detect overload conditions. Further actions in order to prevent the IC from damage can be implemented.

1.6 Mode and TM Input Pins (MODE and TM)

The TM input is only used for Atmel® internal-testing purposes and therefore connected directly to GND. The Mode input is pulled to GND by the 4.7-kΩ resistor R1 and therefore the watchdog is active in the normal operation mode. Especially during the early development phase it can be helpful to have the possibility to deactivate the watchdog in order to debug the application program without disturbing RESETS caused by the watchdog. Therefore the watchdog can be switched off by connecting the MODE pin to VCC externally.

1.7 Reset Output (NRES)

After ramping up the battery voltage or after a wake-up from Sleep mode, the 5V regulator is switched on and the VCC voltage exceeds the undervoltage threshold. The implemented undervoltage delay keeps the NRES output at low level for approximately 10ms after VCC reaches its nominal value. Then it switches to high and the watchdog waits for the trigger sequence from the microcontroller.

The NRES pin switches to low if the watchdog is not triggered correctly (see [Section 1.3 on page 4](#)).

In the ATA6621 the Reset output is a push-pull state supplied by the VCC voltage.

In the Atmel ATA6622/24/26 the Reset output is an open drain output implemented with a single MOS transistor which is switched on in case of a VCC undervoltage or if the watchdog is not triggered correctly. In order to pull up the NRES output of the Atmel ATA6622/24/26 an external resistor connected to VCC is necessary. This resistor (R9) is taken into account on the development board.

If a reset occurs (NRES is Low), the circuit switches to Pre-normal mode (Fail-safe mode).

1.8 KL_15 Input (KL_15) (Atmel ATA6622/24/26 Only)

This pin is a high voltage input used to wake up the device from Sleep or Silent mode. It is an edge sensitive pin (rising edge). It is usually connected to the ignition in order to generate a local wake-up in the application if the ignition is switched on. To protect the pin against voltage transients, a series resistor R12 and a 100-nF ceramic capacitor C8 have to be used. If this pin is not needed, it must be connected to GND.

1.9 Inhibit Output (INH) (Atmel ATA6622/24/26 Only)

This pin is a high-side switch and it is normally used to switch on an external voltage regulator during Normal mode or Fail-safe mode. In Sleep mode or Silent mode the INH output is switched off.

For master node applications it is possible to switch off the external master resistor (R4) by the INH pin.

2. Boosting the Voltage Regulator

For some applications there is a need for a higher current than the internal voltage regulator can deliver (85mA). So it is possible to boost the maximum current by using an external NPN transistor. On the development board there is already a placeholder for this part, into which would fit, for example, the MJD31C in a D-PAK package. In addition to the transistor itself there are two more components to be placed on the development board, the resistor R7 (3.3Ω) and the electrolytic capacitor C4 (2.2μF). The jumper J1 has to be removed in this case.

Note that the output voltage is no longer short-circuit protected when boosting the output current with an external NPN transistor.

The limiting parameter for the output current is the maximum power dissipation of the external NPN transistor. In the version at this stage the thermal resistance of the MJD31C soldered on the minimum pad size is 80K/W, meaning the maximum possible output current in the case of $V_S = 12V$ is approximately 230mA at room temperature. It is not recommended to exceed this limit, because the transistor could be damaged as a result of overtemperature. If a higher output current is required, additional cooling of the external transistor has to be ensured (see [Figure 2-2](#), [Figure 2-3](#) and [Figure 2-4](#) on page 8).

Figure 2-1. Boosting the Voltage Regulator

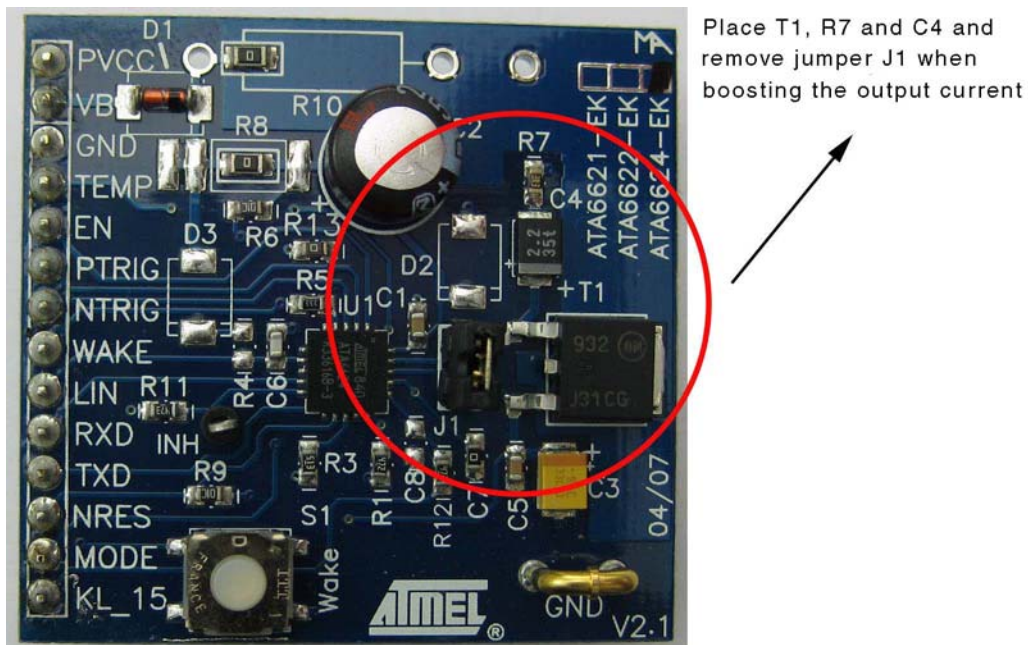

Figure 2-2, Figure 2-3 and Figure 2-4 show the maximum output current (I_{max}) of the voltage regulator as a function of the supply voltage (V_S) at different coolings or thermal resistances (R_{thJA}) of the external NPN transistor T1.

Figure 2-2. I_{max} versus V_S at $R_{thJA} = 80K/W$ (No Additional Cooling)

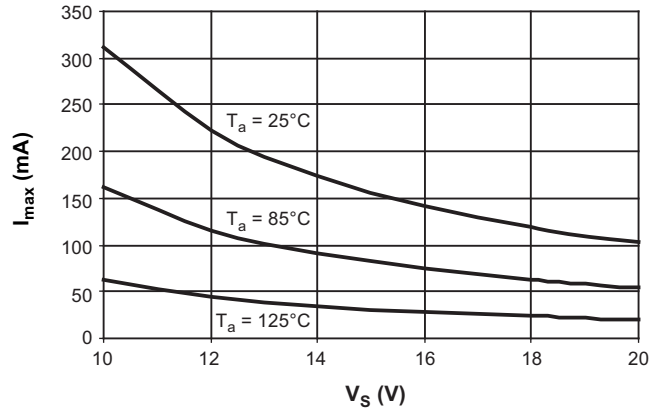

Figure 2-3. I_{max} versus V_S at $R_{thJA} = 50K/W$ (Additional Cooling)

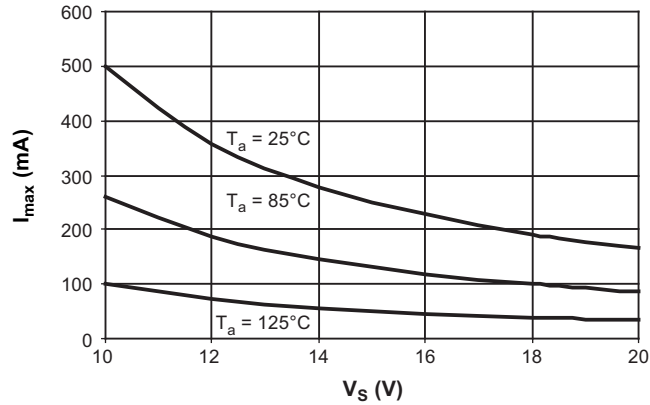

Figure 2-4. I_{max} versus V_S at $R_{thJA} = 20K/W$ (Additional Cooling)

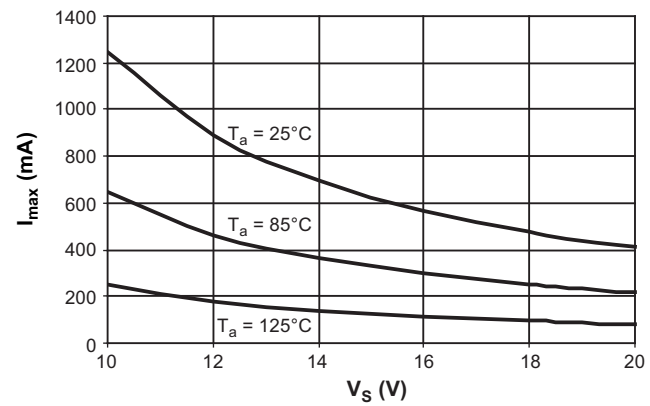

Figure 2-5 to Figure 2-10 on page 11 show some typical operating characteristics measured at the Atmel ATA6621. The supply voltage V_S is approximately a diode forward voltage lower than V_{bat} (reverse battery protection). The external circuitry is shown in Figure 3-1 on page 12.

Figure 2-5. Output Voltage PV_{CC} versus Battery Voltage V_{bat} at Startup

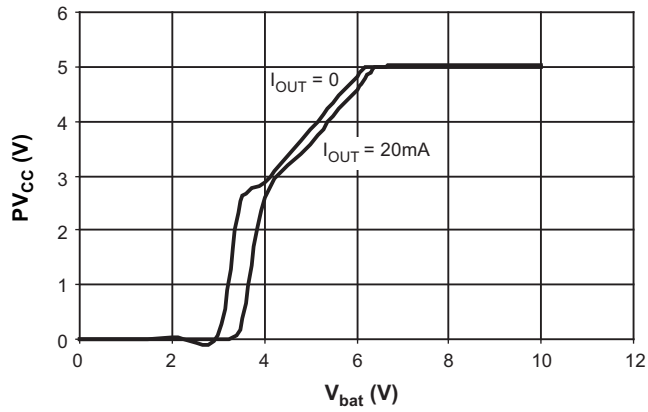

Figure 2-6. Output Voltage PV_{CC} versus Battery Voltage V_{bat} at Different Output Currents

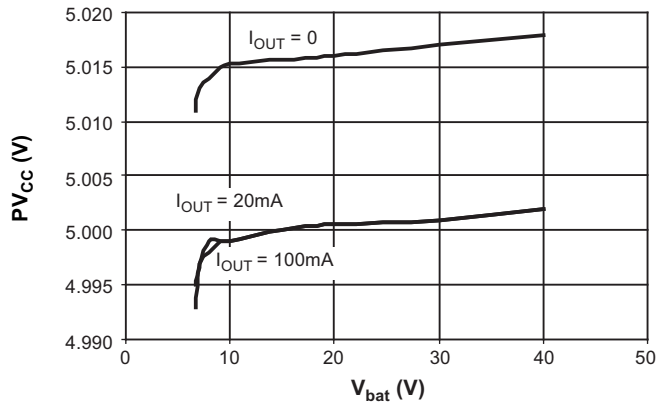

Figure 2-7. Load-transient Response Ch1: I_{OUT} , Ch2: PV_{CC}

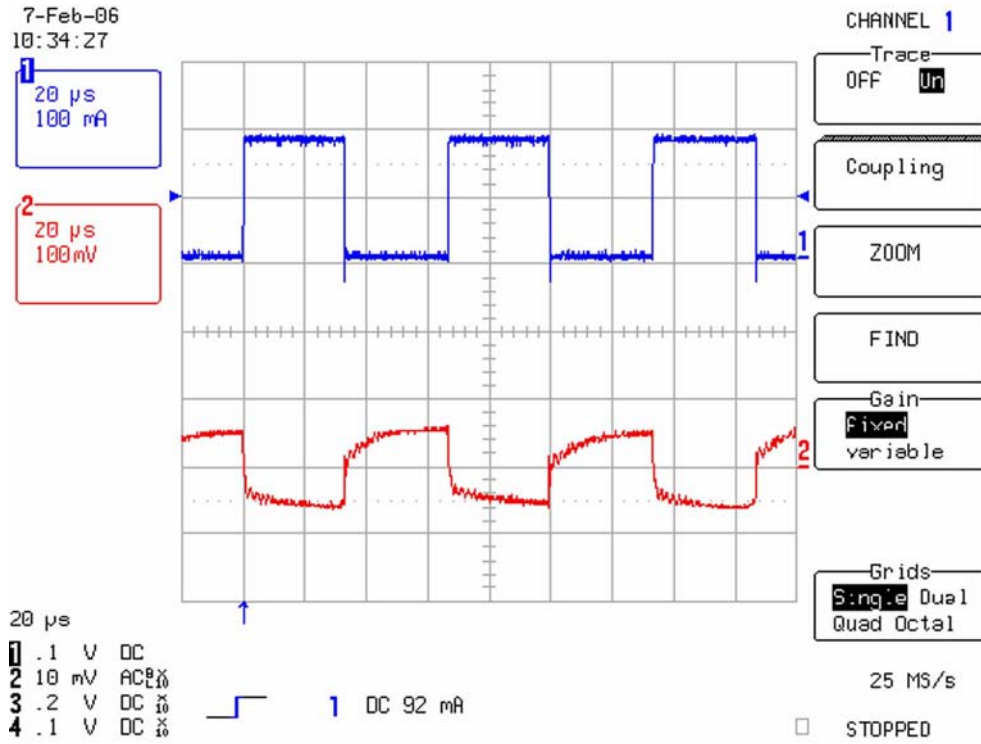

Figure 2-8. Startup Response Ch1: V_S , Ch2: PV_{CC}

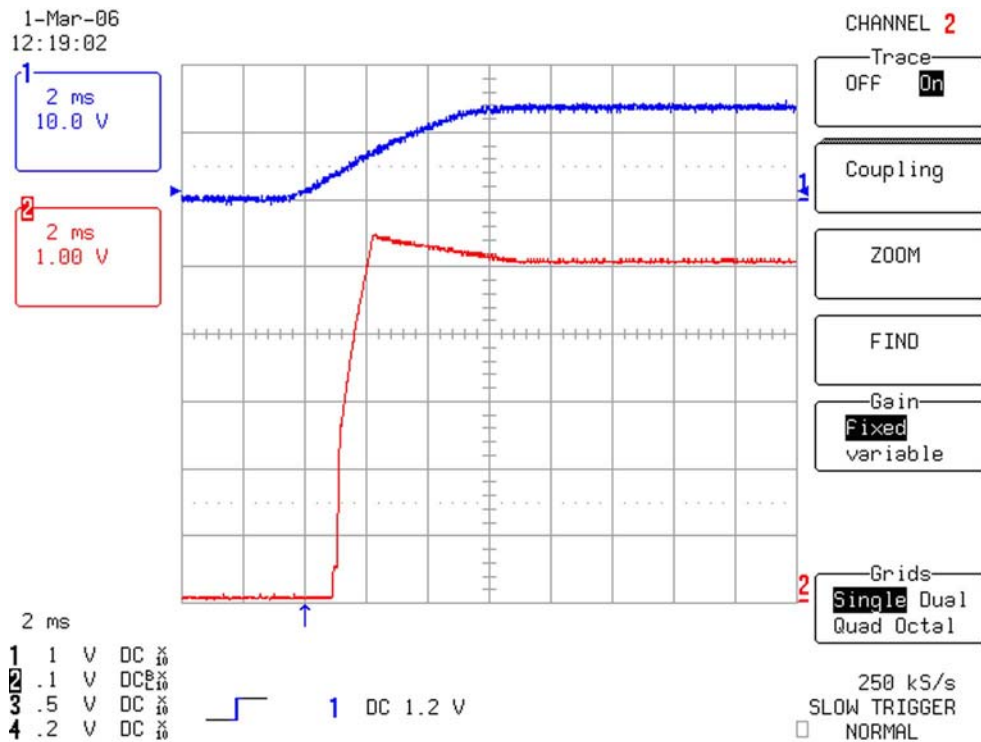

Figure 2-9. Switching from Silent to Normal Mode Ch1: NRES, Ch2: PV_{CC}

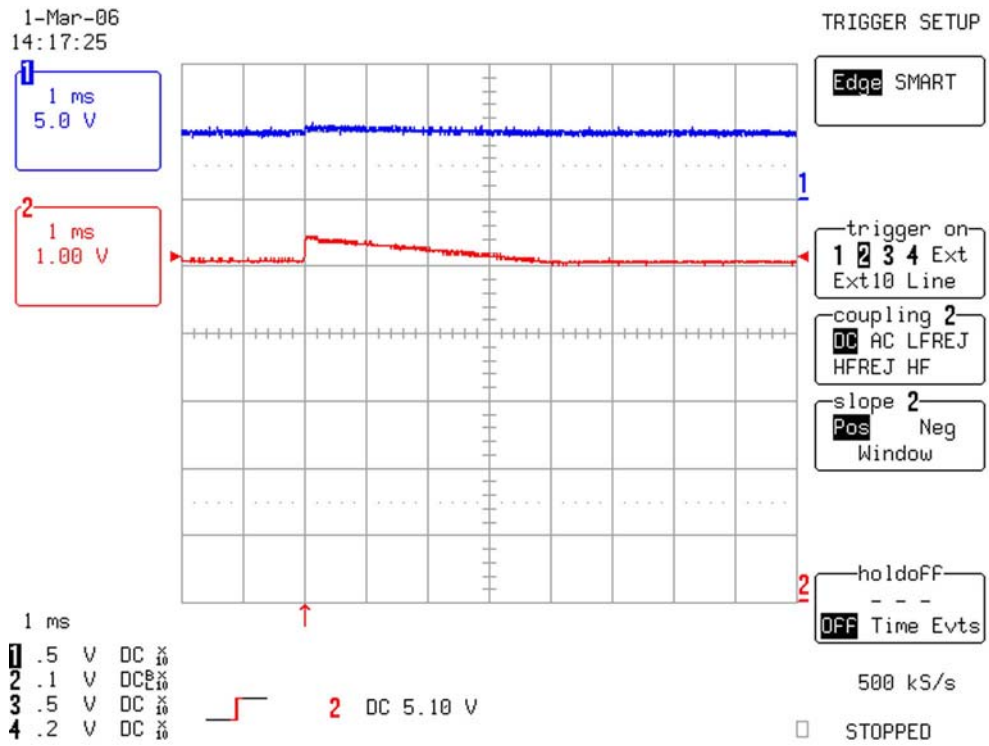
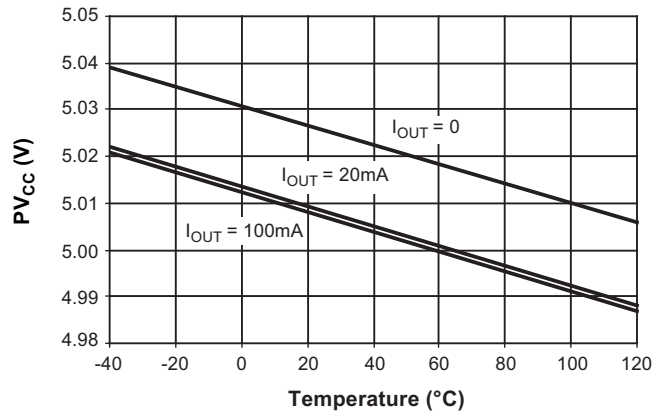
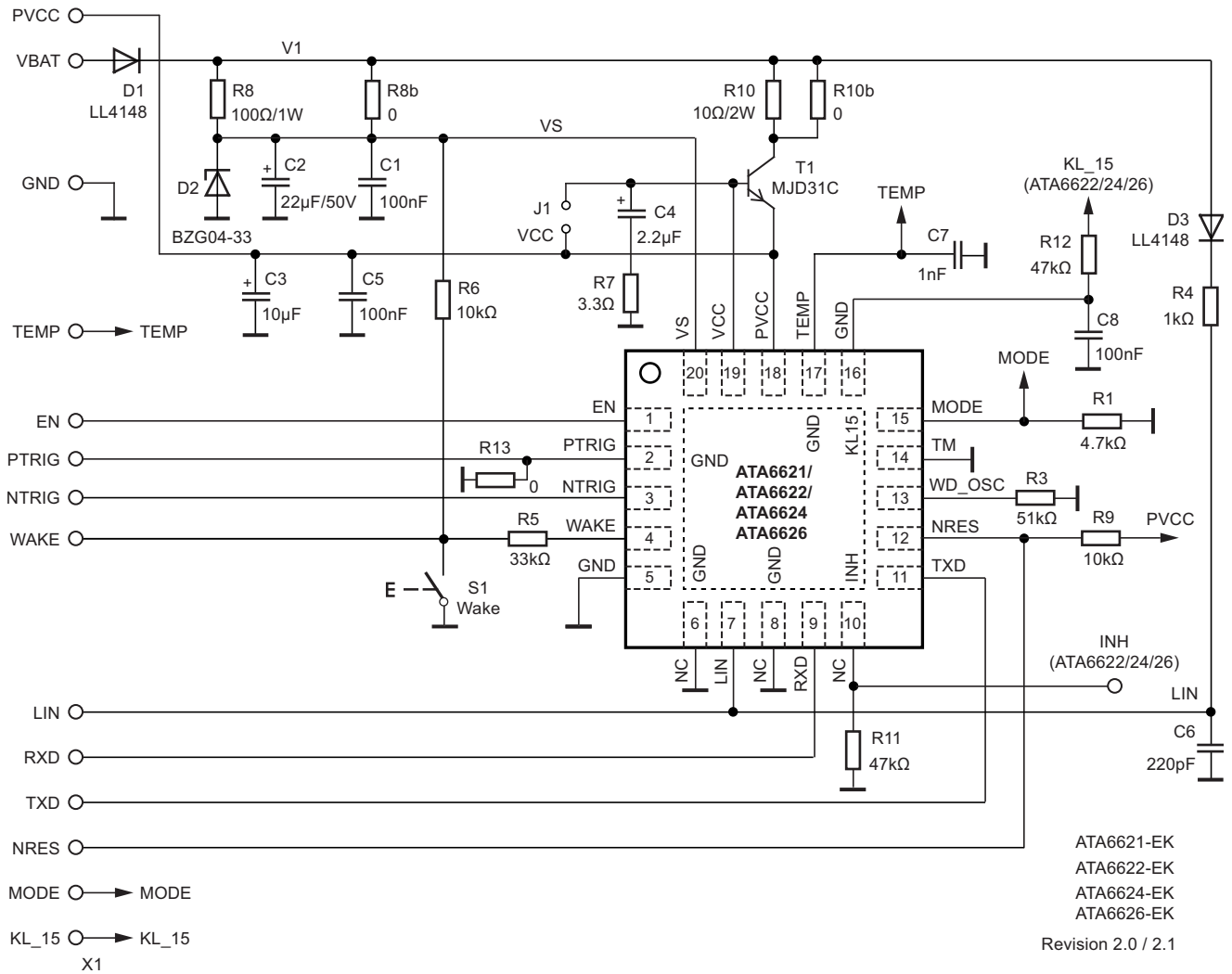

Figure 2-10. Output Voltage PV_{CC} versus Temperature at Different Load Currents



3. Schematic and Layout of the Development Board for the Atmel ATA6621/22/24/26

Figure 3-1. Schematic of the Development Board for the Atmel ATA6621/22/24/26



- Notes:
1. D3 and R4 are only necessary for a master node.
 2. R9 and R13 are only needed for Atmel ATA6622/24/26.
 3. Pin KL_15 and the corresponding external circuitry are only available at the Atmel ATA6622/24/26.
 4. Pin INH and the corresponding external circuitry are only available at the Atmel ATA6622/24/26..
 5. Pin 17 has to be connected to GND by replacing C7 with a 0Ω resistor at Atmel ATA6622/24/26
 6. Atmel ATA6621: Pin 10 has to be connected to GND via R11 = 0. Pin 16 has to be connected to GND by replacing C8 by a 0Ω resistor. R12 is not mounted.

Figure 3-2. Atmel ATA6621/22/24/26 Board Component Placement; Top Side, Top View

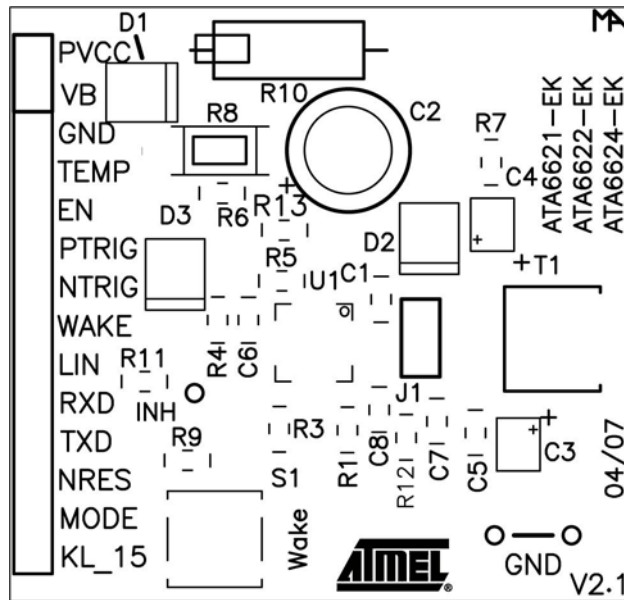

Figure 3-3. Atmel ATA6621/22/24/26 Development Board; Top Side, Top View

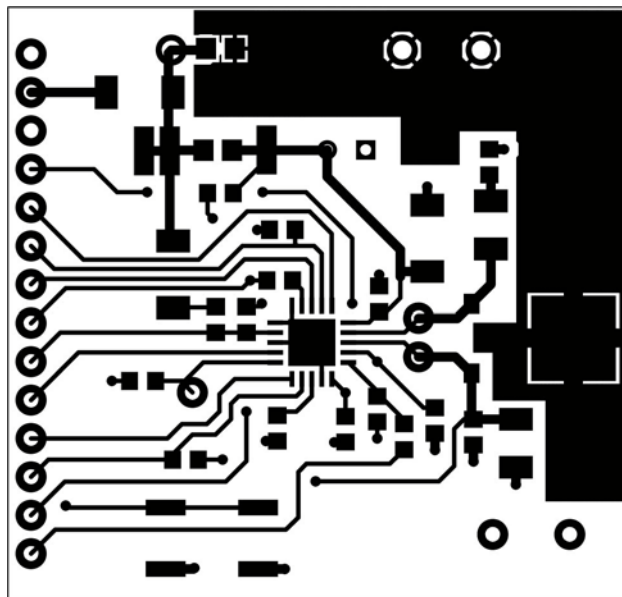
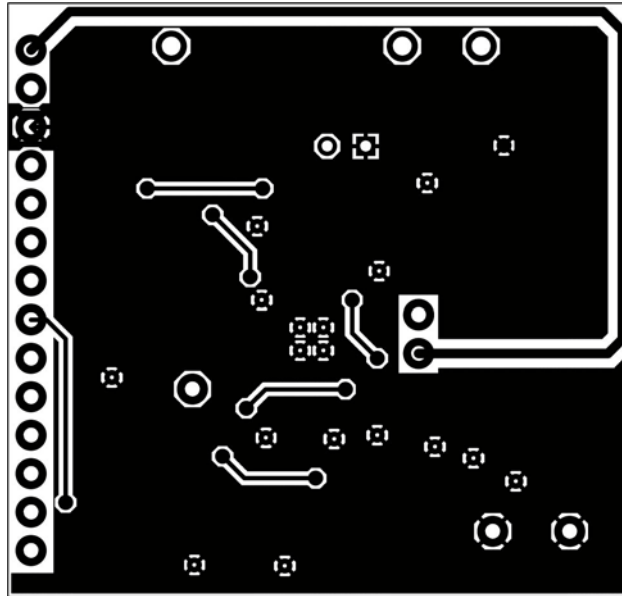

Figure 3-4. Atmel ATA6621/22/24/26 Development Board; Bottom Side, Top View (as if PCB Were Transparent)



For testing purposes two jumpers (JP1 and JP2) have been added to the LIN part of this application in order to have the opportunity to easily change some parameters at the pins NRES and VCC/PVCC. Additionally, the switch S1 has been included to generate a wake pulse.

For the microcontroller part of this slave node, only a few blocking capacitors are necessary. XISP1 is the programming interface and D1, D2, R1 and R2 report the internal status of the slave node. Because the flasher runs with 12V DC, the transistor T1 is needed to transfer the 5V from the microcontroller to the 12V level. Furthermore, the flasher produces some glitches, so that there are some capacitors needed in order to block the 12V power supply.

Figure 4-2. A Simple Application Using the Development Board for the Atmel ATA6624 (Photograph)

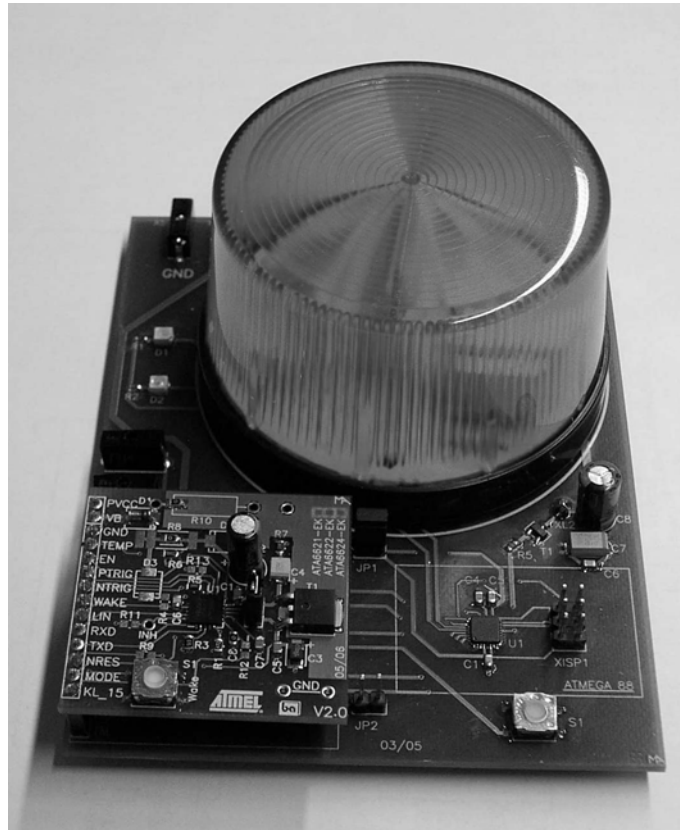

5. Revision History

Please note that the following page numbers referred to in this section refer to the specific revision mentioned, not to this document.

Revision No.	History
4970C-AUTO-06/15	<ul style="list-style-type: none">• Put document in the latest template
4970B-AUTO-03/11	<ul style="list-style-type: none">• ATA6626 added• C Versions added



Atmel Corporation 1600 Technology Drive, San Jose, CA 95110 USA T: (+1)(408) 441.0311 F: (+1)(408) 436.4200 | www.atmel.com

© 2015 Atmel Corporation. / Rev.: 4970C–AUTO–06/15

Atmel®, Atmel logo and combinations thereof, Enabling Unlimited Possibilities®, and others are registered trademarks or trademarks of Atmel Corporation in U.S. and other countries. Other terms and product names may be trademarks of others.

DISCLAIMER: The information in this document is provided in connection with Atmel products. No license, express or implied, by estoppel or otherwise, to any intellectual property right is granted by this document or in connection with the sale of Atmel products. EXCEPT AS SET FORTH IN THE ATMEL TERMS AND CONDITIONS OF SALES LOCATED ON THE ATMEL WEBSITE, ATMEL ASSUMES NO LIABILITY WHATSOEVER AND DISCLAIMS ANY EXPRESS, IMPLIED OR STATUTORY WARRANTY RELATING TO ITS PRODUCTS INCLUDING, BUT NOT LIMITED TO, THE IMPLIED WARRANTY OF MERCHANTABILITY, FITNESS FOR A PARTICULAR PURPOSE, OR NON-INFRINGEMENT. IN NO EVENT SHALL ATMEL BE LIABLE FOR ANY DIRECT, INDIRECT, CONSEQUENTIAL, PUNITIVE, SPECIAL OR INCIDENTAL DAMAGES (INCLUDING, WITHOUT LIMITATION, DAMAGES FOR LOSS AND PROFITS, BUSINESS INTERRUPTION, OR LOSS OF INFORMATION) ARISING OUT OF THE USE OR INABILITY TO USE THIS DOCUMENT, EVEN IF ATMEL HAS BEEN ADVISED OF THE POSSIBILITY OF SUCH DAMAGES. Atmel makes no representations or warranties with respect to the accuracy or completeness of the contents of this document and reserves the right to make changes to specifications and products descriptions at any time without notice. Atmel does not make any commitment to update the information contained herein. Unless specifically provided otherwise, Atmel products are not suitable for, and shall not be used in, automotive applications. Atmel products are not intended, authorized, or warranted for use as components in applications intended to support or sustain life.

SAFETY-CRITICAL, MILITARY, AND AUTOMOTIVE APPLICATIONS DISCLAIMER: Atmel products are not designed for and will not be used in connection with any applications where the failure of such products would reasonably be expected to result in significant personal injury or death ("Safety-Critical Applications") without an Atmel officer's specific written consent. Safety-Critical Applications include, without limitation, life support devices and systems, equipment or systems for the operation of nuclear facilities and weapons systems. Atmel products are not designed nor intended for use in military or aerospace applications or environments unless specifically designated by Atmel as military-grade. Atmel products are not designed nor intended for use in automotive applications unless specifically designated by Atmel as automotive-grade.

Mouser Electronics

Authorized Distributor

Click to View Pricing, Inventory, Delivery & Lifecycle Information:

[Microchip:](#)

[ATA6622-EK](#) [ATA6626-EK](#) [ATA6624-EK](#)



Стандарт Электрон Связь

Мы молодая и активно развивающаяся компания в области поставок электронных компонентов. Мы поставляем электронные компоненты отечественного и импортного производства напрямую от производителей и с крупнейших складов мира.

Благодаря сотрудничеству с мировыми поставщиками мы осуществляем комплексные и плановые поставки широчайшего спектра электронных компонентов.

Собственная эффективная логистика и склад в обеспечивает надежную поставку продукции в точно указанные сроки по всей России.

Мы осуществляем техническую поддержку нашим клиентам и предпродажную проверку качества продукции. На все поставляемые продукты мы предоставляем гарантию .

Осуществляем поставки продукции под контролем ВП МО РФ на предприятия военно-промышленного комплекса России , а также работаем в рамках 275 ФЗ с открытием отдельных счетов в уполномоченном банке. Система менеджмента качества компании соответствует требованиям ГОСТ ISO 9001.

Минимальные сроки поставки, гибкие цены, неограниченный ассортимент и индивидуальный подход к клиентам являются основой для выстраивания долгосрочного и эффективного сотрудничества с предприятиями радиоэлектронной промышленности, предприятиями ВПК и научно-исследовательскими институтами России.

С нами вы становитесь еще успешнее!

Наши контакты:

Телефон: +7 812 627 14 35

Электронная почта: sales@st-electron.ru

Адрес: 198099, Санкт-Петербург,
Промышленная ул, дом № 19, литера Н,
помещение 100-Н Офис 331