

Low Charge Injection 8-Channel High Voltage Analog Switches with Bleed Resistors

Features

- ▶ HVCMOS® technology for high performance
- ▶ Very low quiescent power dissipation (10µA max.)
- ▶ Output on-resistance (22Ω typ.)
- ▶ Integrated bleed resistors on the outputs
- ▶ Low parasitic capacitances
- ▶ DC to 50MHz small signal frequency response
- ▶ -60dB typical output off isolation at 5.0MHz
- ▶ CMOS logic circuitry for low power
- ▶ Excellent noise immunity
- ▶ On-chip shift register, latch and clear logic circuitry
- ▶ Flexible high voltage supplies

Applications

- ▶ Medical ultrasound imaging
- ▶ Piezoelectric transducer drivers

General Description

The Supertex HV232 is a low charge injection 8-channel, high-voltage, analog switch integrated circuit (IC) with bleed resistors. This device can be used in applications requiring high voltage switching controlled by low voltage control signals, such as ultrasound imaging and printers. The bleed resistors eliminate voltage built up on capacitive loads such as piezoelectric transducers. Input data is shifted into an 8-bit shift register which can then be retained in an 8-bit latch. To reduce any possible clock feed-through noise, Latch Enable (\overline{LE}) should be left high until all bits are clocked in. Using HVCMOS® technology, this switch combines high voltage bilateral DMOS switches and low power CMOS logic to provide efficient control of high voltage analog signals.

This IC is suitable for various combinations of high voltage supplies, e.g., V_{PP}/V_{NN} : +50V/-150V, or +100V/-100V.

Block Diagram

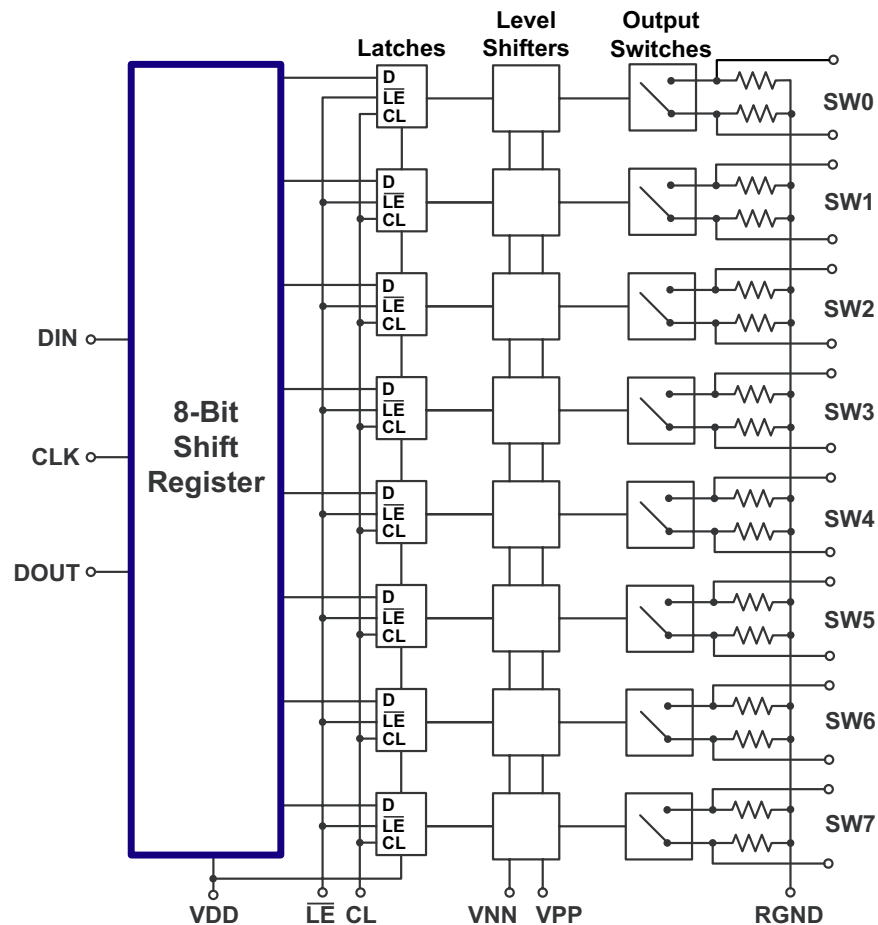

Ordering Information

Device	Package Options	
	48-Lead LQFP 7.00x7.00mm body 1.60mm height (max) 0.50mm pitch	28-Lead PLCC .453x.453in body .180in height (max) .050in pitch
HV232	HV232FG-G	HV232PJ-G



-G indicates the part is RoHS compliant (Green)

Absolute Maximum Ratings

Parameter	Value
V _{DD} logic power supply voltage	-0.5V to +15V
V _{PP} - V _{NN} supply voltage	220V
V _{PP} positive high voltage supply	-0.5V to V _{NN} +200V
V _{NN} negative high voltage supply	+0.5V to -200V
Logic input voltages	-0.5V to V _{DD} +0.3V
Analog signal range	V _{NN} to V _{PP}
Peak analog signal current/channel	3.0A
Storage temperature	-65°C to +150°C
Power dissipation:	
48-Lead LQFP	1.0W
28-Lead PLCC	1.2W

Absolute Maximum Ratings are those values beyond which damage to the device may occur. Functional operation under these conditions is not implied. Continuous operation of the device at the absolute rating level may affect device reliability. All voltages are referenced to device ground.

Operating Conditions

Sym	Parameter	Value
V _{DD}	Logic power supply voltage ^{1,3}	4.5V to 13.2V
V _{PP}	Positive high voltage supply ^{1,3}	40V to V _{NN} +200V
V _{NN}	Negative high voltage supply ^{1,3}	-40V to -160V
V _{IH}	High level input voltage	V _{DD} -1.5V to V _{DD}
V _{IL}	Low-level input voltage	0V to 1.5V
V _{SIG}	Analog signal voltage peak-to-peak ²	V _{NN} +10V to V _{PP} -10V
T _A	Operating free air temperature	0°C to 70°C

Notes:

- Power up/down sequence is arbitrary except GND must be powered -up first and powered down last.
- V_{SIG} must be V_{NN} ≤ V_{SIG} ≤ V_{PP} or floating during power up/down transition.
- Rise and fall times of power supplies V_{DD}, V_{PP} and V_{NN} should not be less than 1.0msec.

Pin Configuration



48-Lead LQFP (FG)
(top view)

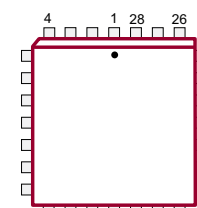

28-Lead PLCC (PJ)
(top view)

Product Marking

Top Marking



YY = Year Sealed
WW = Week Sealed
L = Lot Number
C = Country of Origin*
A = Assembler ID*
— = "Green" Packaging
*May be part of top marking

Bottom Marking



Package may or may not include the following marks: Si or

48-Lead LQFP (FG)

Top Marking



YY = Year Sealed
WW = Week Sealed
L = Lot Number
C = Country of Origin*
A = Assembler ID*
— = "Green" Packaging
*May be part of top marking

Bottom Marking

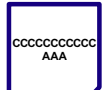

Package may or may not include the following marks: Si or

28-Lead PLCC (PJ)

DC Electrical Characteristics (Over operating conditions unless otherwise specified)

Sym	Parameter	0°C		+25°C			+70°C		Units	Conditions
		Min	Max	Min	Typ	Max	Min	Max		
R _{ONS}	Small signal switch on-resistance	-	30	-	26	38	-	48	Ω	I _{SIG} = 5.0mA, V _{PP} = +40V, V _{NN} = -160V
		-	25	-	22	27	-	32		I _{SIG} = 200mA, V _{NN} = -160V
		-	25	-	22	27	-	30		I _{SIG} = 5.0mA, V _{PP} = +100V, V _{NN} = -100V
		-	18	-	18	24	-	27		I _{SIG} = 200mA, V _{NN} = -100V
		-	23	-	20	25	-	30		I _{SIG} = 5.0mA, V _{PP} = +160V, V _{NN} = -40V
		-	22	-	16	25	-	27		I _{SIG} = 200mA, V _{NN} = -40V
ΔR _{ONS}	Small signal switch on-resistance matching	-	20	-	5.0	20	-	20	%	I _{SIG} = 5.0mA, V _{PP} = +100V, V _{NN} = -100V
R _{ONL}	Large signal switch on-resistance	-	-	-	15	-	-	-	Ω	V _{SIG} = V _{PP} -10V, I _{SIG} = 1.0A
R _{INT}	Output switch shunt resistance	-	-	20	35	50	-	-	KΩ	Output switch to R _{GND} I _{RINT} = 0.5mA
I _{SOL}	Switch off leakage per switch	-	5.0	-	1.0	10	-	15	μA	V _{SIG} = V _{PP} -10V
V _{OS}	DC offset switch off	-	300	-	100	300	-	300	mV	No load
	DC offset switch on	-	500	-	100	500	-	500	mV	No load
I _{PPQ}	Quiescent V _{PP} supply current	-	-	-	10	50	-	-	μA	All switches off
I _{NNQ}	Quiescent V _{NN} supply current	-	-	-	-10	-50	-	-	μA	All switches off
I _{PPQ}	Quiescent V _{PP} supply current	-	-	-	10	50	-	-	μA	All switches on, I _{SW} = 5.0mA
I _{NNQ}	Quiescent V _{NN} supply current	-	-	-	-10	-50	-	-	μA	All switches on, I _{SW} = 5.0mA
I _{SW}	Switch output peak current	-	3.0	-	3.0	2.0	-	2.0	A	V _{SIG} duty cycle - 0.1%
f _{SW}	Output switching frequency	-	-	-	-	50	-	-	kHz	Duty cycle = 50%
I _{PP}	Supply current	-	6.5	-	-	7.0	-	8.0	mA	V _{PP} = +40V, V _{NN} = -160V
		-	4.0	-	-	5.0	-	5.5		V _{PP} = +100V, V _{NN} = -100V
		-	4.0	-	-	5.0	-	5.5		V _{PP} = +160V, V _{NN} = -40V
I _{NN}	Supply current	-	6.5	-	-	7.0	-	8.0	mA	V _{PP} = +40V, V _{NN} = -160V
		-	4.0	-	-	5.0	-	5.5		V _{PP} = +100V, V _{NN} = -100V
		-	4.0	-	-	5.0	-	5.5		V _{PP} = +160V, V _{NN} = -40V
I _{DD}	Logic supply average current	-	4.0	-	-	4.0	-	4.0	mA	f _{CLK} = 5.0MHz, V _{DD} = 5.0V
I _{DDQ}	Logic supply quiescent current	-	10	-	-	10	-	10	μA	---
I _{SOR}	Data out source current	0.45	-	0.45	0.70	-	0.40	-	mA	V _{OUT} = V _{DD} -0.7V
I _{SINK}	Data out sink current	0.45	-	0.45	0.70	-	0.40	-	mA	V _{OUT} = 0.7V
C _{IN}	Logic input capacitance	-	10	-	-	10	-	10	pF	---

AC Electrical Characteristics (Over recommended operating conditions, $V_{DD} = 5.0V$, unless otherwise specified)

Sym	Parameter	0°C		+25°C			+70°C		Units	Conditions
		Min	Max	Min	Typ	Max	Min	Max		
t_{SD}	Set up time before \overline{LE} rises	150	-	150	-	-	150	-	ns	---
t_{WLE}	Time width of \overline{LE}	150	-	150	-	-	150	-	ns	---
t_{DO}	Clock delay time to data out	55	150	60	-	150	70	150	ns	---
t_{WCL}	Time width of CL	150	-	150	-	-	150	-	ns	---
t_{SU}	Set up time data to clock	15	-	15	8.0	-	20	-	ns	---
t_H	Hold time data from clock	35	-	35	-	-	35	-	ns	---
f_{CLK}	Clock frequency	-	5.0	-	-	5.0	-	5.0	MHz	50% Duty cycle, $f_{DATA} = f_{CLK}/2$
t_R, t_F	Clock rise and fall times	-	1.0	-	-	1.0	-	1.0	μs	---
t_{ON}	Turn on time	-	5.0	-	-	5.0	-	5.0	μs	$V_{SIG} = V_{PP} - 10V, R_L = 10k\Omega$
t_{OFF}	Turn off time	-	5.0	-	-	5.0	-	5.0	μs	$V_{SIG} = V_{PP} - 10V, R_L = 10k\Omega$
dv/dt	Maximun V_{SIG} slew rate	-	20	-	-	20	-	20	V/ns	$V_{PP} = +160V, V_{NN} = -40V$
		-	20	-	-	20	-	20		$V_{PP} = +100V, V_{NN} = -100V$
		-	20	-	-	20	-	20		$V_{PP} = +40V, V_{NN} = -160V$
K_O	Off isolation	-30	-	-30	-33	-	-30	-	dB	f = 5.0MHz, 1.0k Ω /15pF load
		-58	-	-58	-	-	-58	-		f = 5.0MHz, 50 Ω load
K_{CR}	Switch crosstalk	-60	-	-60	-70	-	-60	-	dB	f = 5.0MHz, 50 Ω load
I_{ID}	Output switch isolation diode current	-	300	-	-	300	-	300	mA	300ns pulse width, 2.0% duty cycle
$C_{SG(OFF)}$	Off capacitance SW to GND	5.0	17	5.0	12	17	5.0	17	pF	0V, f = 1.0MHz
$C_{SG(ON)}$	On capacitance SW to GND	25	50	25	38	50	25	50	pF	0V, f = 1.0MHz
$+V_{SPK}$	Output voltage spike	-	-	-	-	150	-	-	mV	$V_{PP} = +40V, V_{NN} = -160V, R_L = 50\Omega$
$-V_{SPK}$		-	-	-	-	150	-	-		
$+V_{SPK}$		-	-	-	-	150	-	-		$V_{PP} = +100V, V_{NN} = -100V, R_L = 50\Omega$
$-V_{SPK}$		-	-	-	-	150	-	-		
$+V_{SPK}$		-	-	-	-	150	-	-		$V_{PP} = +160V, V_{NN} = -40V, R_L = 50\Omega$
$-V_{SPK}$		-	-	-	-	150	-	-		

Truth Table

D0	D1	D2	D3	D4	D5	D6	D7	\overline{LE}	CLK	SW0	SW1	SW2	SW3	SW4	SW5	SW6	SW7
L								L	L	Off							
H								L	L	On							
	L							L	L		Off						
	H							L	L		On						
		L						L	L			Off					
		H						L	L			On					
			L					L	L				Off				
			H					L	L				On				
				L				L	L					Off			
				H				L	L					On			
					L			L	L						Off		
					H			L	L						On		
						L		L	L							Off	
						H		L	L							On	
							L	L	L								Off
							H	L	L								On
X	X	X	X	X	X	X	X	H	L	Hold Previous State							
X	X	X	X	X	X	X	X	X	H	All Switches Off							

Notes:

1. The eight switches operate independently.
2. Serial data is clocked in on the L to H transition of the CLK.
3. The switches go to a state retaining their present condition at the rising edge of \overline{LE} . When \overline{LE} is low the shift register data flow through the latch.
4. D_{OUT} is high when data in the shift register 7 is high.
5. Shift register clocking has no effect on the switch states if \overline{LE} is high.
6. The CLR clear input overrides all other inputs.

Logic Timing Waveforms

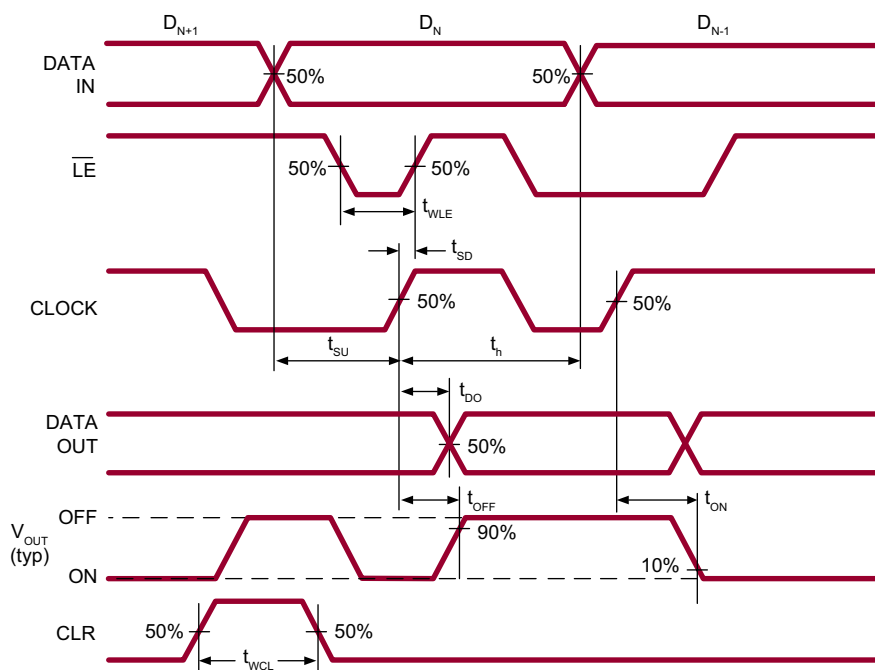

Test Circuits



Pin Description (48-Lead LQFP)

Pin	Function	Pin	Function
1	SW5	25	VNN
2	N/C	26	N/C
3	SW4	27	RGND
4	N/C	28	GND
5	SW4	29	VDD
6	N/C	30	N/C
7	N/C	31	N/C
8	SW3	32	N/C
9	N/C	33	DIN
10	SW3	34	CLK
11	N/C	35	$\overline{\text{LE}}$
12	SW2	36	CLR
13	N/C	37	DOUT
14	SW2	38	N/C
15	N/C	39	SW7
16	SW1	40	N/C
17	N/C	41	SW7
18	SW1	42	N/C
19	N/C	43	SW6
20	SW0	44	N/C
21	N/C	45	SW6
22	SW0	46	N/C
23	N/C	47	SW5
24	VPP	48	N/C

Pin Description (28-Lead PLCC)

Pin	Function	Pin	Function
1	SW3	15	N/C
2	SW3	16	DIN
3	SW2	17	CLK
4	SW2	18	$\overline{\text{LE}}$
5	SW1	19	CL
6	SW1	20	DOUT
7	SW0	21	SW7
8	SW0	22	SW7
9	N/C	23	SW6
10	VPP	24	SW6
11	RGND	25	SW5
12	VNN	26	SW5
13	GND	27	SW4
14	VDD	28	SW4

48-Lead LQFP Package Outline (FG)

7.00x7.00mm body, 1.60mm height (max), 0.50mm pitch



Note:
1. A Pin 1 identifier must be located in the index area indicated. The Pin 1 identifier can be: a molded mark/identifier; an embedded metal marker; or a printed indicator.

Symbol	A	A1	A2	b	D	D1	E	E1	e	L	L1	L2	θ	
Dimension (mm)	MIN	1.40*	0.05	1.35	0.17	8.80*	6.80*	8.80*	6.80*	0.50 BSC	0.45	1.00 REF	0.25 BSC	0°
	NOM	-	-	1.40	0.22	9.00	7.00	9.00	7.00		0.60		3.5°	
	MAX	1.60	0.15	1.45	0.27	9.20*	7.20*	9.20*	7.20*		0.75		7°	

JEDEC Registration MS-026, Variation BBC, Issue D, Jan. 2001.
* This dimension is not specified in the JEDEC drawing.

Drawings are not to scale.
Supertex Doc. #: DSPD-48LQFPFG Version, D041309.

28-Lead PLCC Package Outline (PJ)

.453x.453in. body, .180in. height (max), .050in. pitch

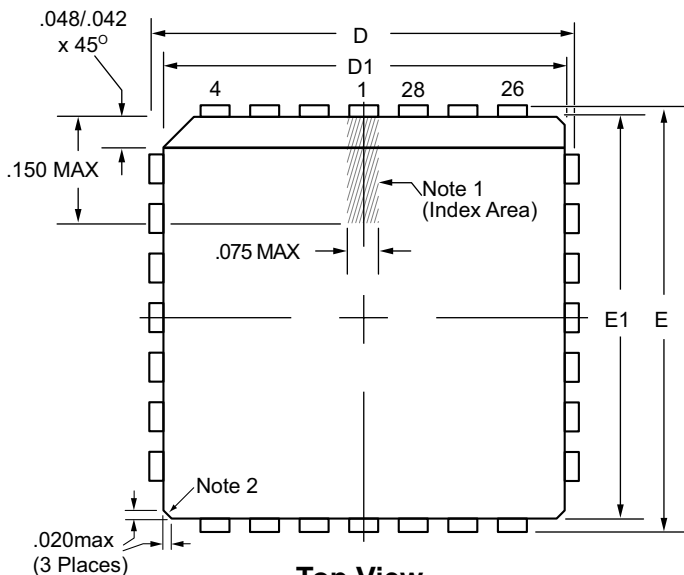

Top View

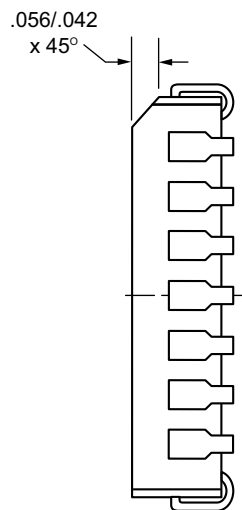

Vertical Side View

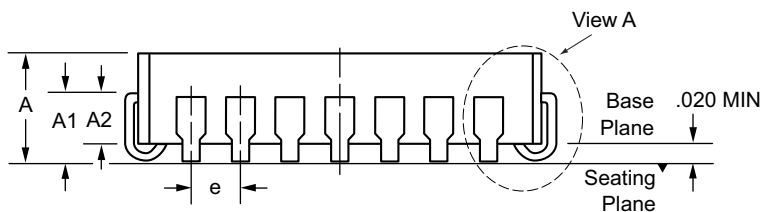

Horizontal Side View

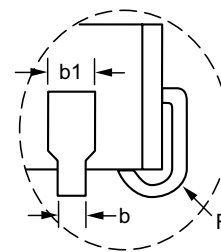

View A

Notes:

1. A Pin 1 identifier must be located in the index area indicated. The Pin 1 identifier can be: a molded mark/identifier; an embedded metal marker; or a printed indicator.
2. Actual shape of this feature may vary.

Symbol		A	A1	A2	b	b1	D	D1	E	E1	e	R
Dimension (inches)	MIN	.165	.090	.062	.013	.026	.485	.450	.485	.450	.050 BSC	.025
	NOM	.172	.105	-	-	-	.490	.453	.490	.453		.035
	MAX	.180	.120	.083	.021	.032	.495	.456	.495	.456		.045

JEDEC Registration MS-018, Variation AB, Issue A, June, 1993.

Drawings not to scale.

Supertex Doc. #: DSPD-28PLCCPJ, Version B031111.

(The package drawing(s) in this data sheet may not reflect the most current specifications. For the latest package outline information go to <http://www.supertex.com/packaging.html>.)

Supertex inc. does not recommend the use of its products in life support applications, and will not knowingly sell them for use in such applications unless it receives an adequate "product liability indemnification insurance agreement." Supertex inc. does not assume responsibility for use of devices described, and limits its liability to the replacement of the devices determined defective due to workmanship. No responsibility is assumed for possible omissions and inaccuracies. Circuitry and specifications are subject to change without notice. For the latest product specifications refer to the Supertex inc. (website: <http://www.supertex.com>)



Стандарт Электрон Связь

Мы молодая и активно развивающаяся компания в области поставок электронных компонентов. Мы поставляем электронные компоненты отечественного и импортного производства напрямую от производителей и с крупнейших складов мира.

Благодаря сотрудничеству с мировыми поставщиками мы осуществляем комплексные и плановые поставки широчайшего спектра электронных компонентов.

Собственная эффективная логистика и склад в обеспечивает надежную поставку продукции в точно указанные сроки по всей России.

Мы осуществляем техническую поддержку нашим клиентам и предпродажную проверку качества продукции. На все поставляемые продукты мы предоставляем гарантию .

Осуществляем поставки продукции под контролем ВП МО РФ на предприятия военно-промышленного комплекса России , а также работаем в рамках 275 ФЗ с открытием отдельных счетов в уполномоченном банке. Система менеджмента качества компании соответствует требованиям ГОСТ ISO 9001.

Минимальные сроки поставки, гибкие цены, неограниченный ассортимент и индивидуальный подход к клиентам являются основой для выстраивания долгосрочного и эффективного сотрудничества с предприятиями радиоэлектронной промышленности, предприятиями ВПК и научно-исследовательскими институтами России.

С нами вы становитесь еще успешнее!

Наши контакты:

Телефон: +7 812 627 14 35

Электронная почта: sales@st-electron.ru

Адрес: 198099, Санкт-Петербург,
Промышленная ул, дом № 19, литера Н,
помещение 100-Н Офис 331