

# MJ21193, MJ21194

Preferred Device

## Silicon Power Transistors

The MJ21193 (PNP) and MJ21194 (NPN) utilize Perforated Emitter technology and are specifically designed for high power audio output, disk head positioners and linear applications.

### Features

- Total Harmonic Distortion Characterized
- High DC Current Gain –  $h_{FE} = 25 \text{ Min @ } I_C = 8 \text{ Adc}$
- Excellent Gain Linearity
- High SOA: 2.5 A, 80 V, 1 Second
- Pb-Free Packages are Available\*

### MAXIMUM RATINGS

Rating	Symbol	Value	Unit
Collector–Emitter Voltage	$V_{CEO}$	250	Vdc
Collector–Base Voltage	$V_{CBO}$	400	Vdc
Emitter–Base Voltage	$V_{EBO}$	5	Vdc
Collector–Emitter Voltage – 1.5 V	$V_{CEX}$	400	Vdc
Collector Current – Continuous Peak (Note 1)	$I_C$	16 30	Adc
Base Current – Continuous	$I_B$	5	Adc
Total Power Dissipation @ $T_C = 25^\circ\text{C}$ Derate Above $25^\circ\text{C}$	$P_D$	250 1.43	W W/ $^\circ\text{C}$
Operating and Storage Junction Temperature Range	$T_J, T_{stg}$	– 65 to +200	$^\circ\text{C}$

### THERMAL CHARACTERISTICS

Characteristic	Symbol	Max	Unit
Thermal Resistance, Junction–to–Case	$R_{\theta JC}$	0.7	$^\circ\text{C}/\text{W}$

Stresses exceeding Maximum Ratings may damage the device. Maximum Ratings are stress ratings only. Functional operation above the Recommended Operating Conditions is not implied. Extended exposure to stresses above the Recommended Operating Conditions may affect device reliability.

1. Pulse Test: Pulse Width = 5  $\mu\text{s}$ , Duty Cycle  $\leq 10\%$ . (continued)

\*For additional information on our Pb-Free strategy and soldering details, please download the ON Semiconductor Soldering and Mounting Techniques Reference Manual, SOLDERRM/D.



ON Semiconductor®

<http://onsemi.com>

## 16 AMP COMPLEMENTARY SILICON POWER TRANSISTORS 250 VOLTS, 250 WATTS

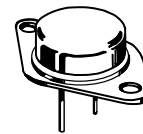

TO-204AA (TO-3)  
CASE 1-07  
STYLE 1

### MARKING DIAGRAM



MJ2119x = Device Code  
x = 3 or 4  
G = Pb-Free Package  
A = Assembly Location  
YY = Year  
WW = Work Week  
MEX = Country of Origin

### ORDERING INFORMATION

Device	Package	Shipping†
MJ21193	TO-3	100 Units / Tray
MJ21193G	TO-3 (Pb-Free)	100 Units / Tray
MJ21194	TO-3	100 Units / Tray
MJ21194G	TO-3 (Pb-Free)	100 Units / Tray

†For information on tape and reel specifications, including part orientation and tape sizes, please refer to our Tape and Reel Packaging Specifications Brochure, BRD8011/D.

Preferred devices are recommended choices for future use and best overall value.

# MJ21193, MJ21194

## ELECTRICAL CHARACTERISTICS (T<sub>C</sub> = 25°C unless otherwise noted)

Characteristic	Symbol	Min	Typ	Max	Unit
<b>OFF CHARACTERISTICS</b>					
Collector-Emitter Sustaining Voltage (I <sub>C</sub> = 100 mA <sub>dc</sub> , I <sub>B</sub> = 0)	V <sub>CEO(sus)</sub>	250	-	-	V <sub>dc</sub>
Collector Cutoff Current (V <sub>CE</sub> = 200 V <sub>dc</sub> , I <sub>B</sub> = 0)	I <sub>CEO</sub>	-	-	100	μA <sub>dc</sub>
Emitter Cutoff Current (V <sub>CE</sub> = 5 V <sub>dc</sub> , I <sub>C</sub> = 0)	I <sub>EBO</sub>	-	-	100	μA <sub>dc</sub>
Collector Cutoff Current (V <sub>CE</sub> = 250 V <sub>dc</sub> , V <sub>BE(off)</sub> = 1.5 V <sub>dc</sub> )	I <sub>CEX</sub>	-	-	100	μA <sub>dc</sub>

## SECOND BREAKDOWN

Second Breakdown Collector Current with Base Forward Biased (V <sub>CE</sub> = 50 V <sub>dc</sub> , t = 1 s (non-repetitive)) (V <sub>CE</sub> = 80 V <sub>dc</sub> , t = 1 s (non-repetitive))	I <sub>S/b</sub>	5 2.5	- -	- -	A <sub>dc</sub>
---	------------------	----------	--------	--------	-----------------

## ON CHARACTERISTICS

DC Current Gain (I <sub>C</sub> = 8 A <sub>dc</sub> , V <sub>CE</sub> = 5 V <sub>dc</sub> ) (I <sub>C</sub> = 16 A <sub>dc</sub> , I <sub>B</sub> = 5 A <sub>dc</sub> )	h <sub>FE</sub>	25 8	- -	75	
Base-Emitter On Voltage (I <sub>C</sub> = 8 A <sub>dc</sub> , V <sub>CE</sub> = 5 V <sub>dc</sub> )	V <sub>BE(on)</sub>	-	-	2.2	V <sub>dc</sub>
Collector-Emitter Saturation Voltage (I <sub>C</sub> = 8 A <sub>dc</sub> , I <sub>B</sub> = 0.8 A <sub>dc</sub> ) (I <sub>C</sub> = 16 A <sub>dc</sub> , I <sub>B</sub> = 3.2 A <sub>dc</sub> )	V <sub>CE(sat)</sub>	- -	- -	1.4 4	V <sub>dc</sub>

## DYNAMIC CHARACTERISTICS

Total Harmonic Distortion at the Output V <sub>RMS</sub> = 28.3 V, f = 1 kHz, P <sub>LOAD</sub> = 100 W <sub>RMS</sub> h <sub>FE</sub> unmatched (Matched pair h <sub>FE</sub> = 50 @ 5 A/5 V) h <sub>FE</sub> matched	T <sub>HD</sub>	- -	0.8 0.08	- -	%
Current Gain Bandwidth Product (I <sub>C</sub> = 1 A <sub>dc</sub> , V <sub>CE</sub> = 10 V <sub>dc</sub> , f <sub>test</sub> = 1 MHz)	f <sub>T</sub>	4	-	-	MHz
Output Capacitance (V <sub>CB</sub> = 10 V <sub>dc</sub> , I <sub>E</sub> = 0, f <sub>test</sub> = 1 MHz)	C <sub>ob</sub>	-	-	500	pF

NOTE: Pulse Test: Pulse Width = 300 μs, Duty Cycle ≤2%

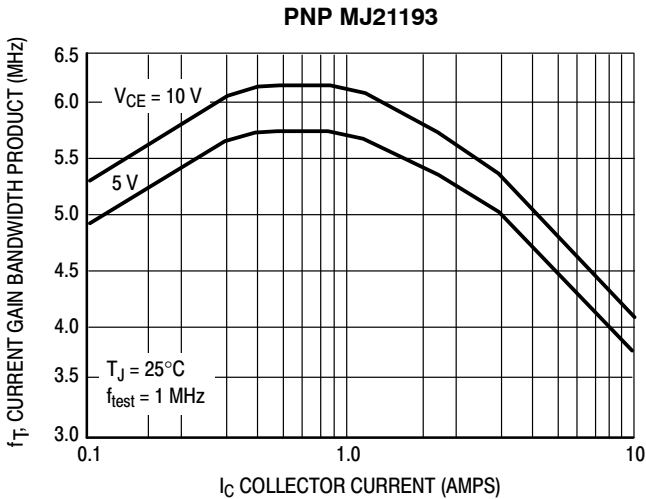

**Figure 1. Typical Current Gain Bandwidth Product**

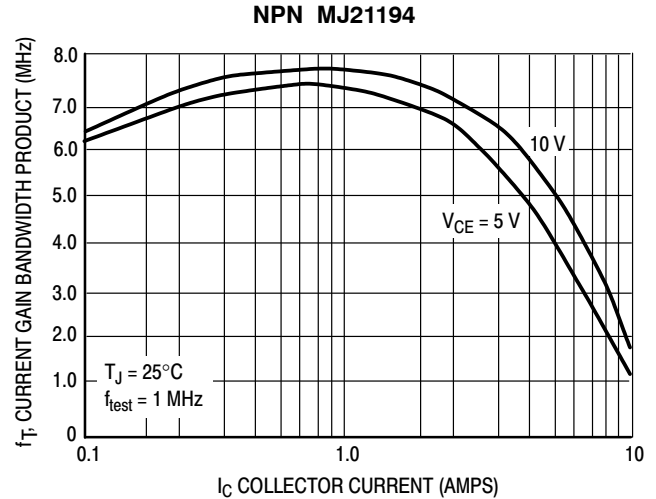
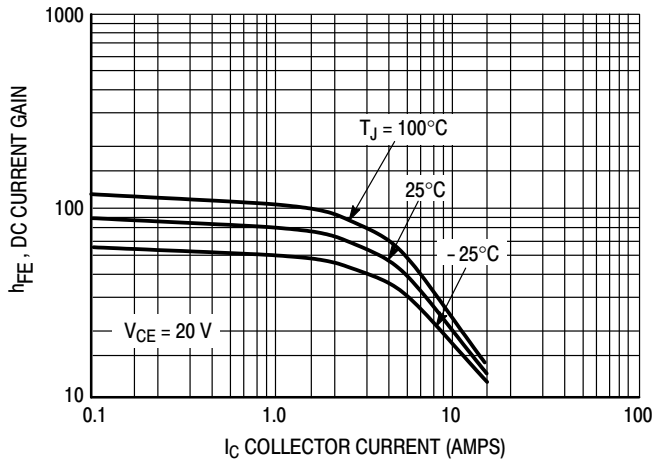

**Figure 2. Typical Current Gain Bandwidth Product**

# MJ21193, MJ21194

## TYPICAL CHARACTERISTICS

**PNP MJ21193**



**Figure 3. DC Current Gain,  $V_{CE} = 20$  V**

**NPN MJ21194**

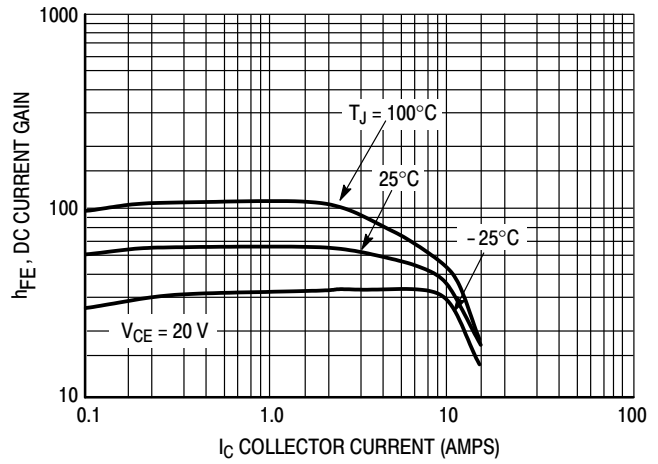

**Figure 4. DC Current Gain,  $V_{CE} = 20$  V**

**PNP MJ21193**

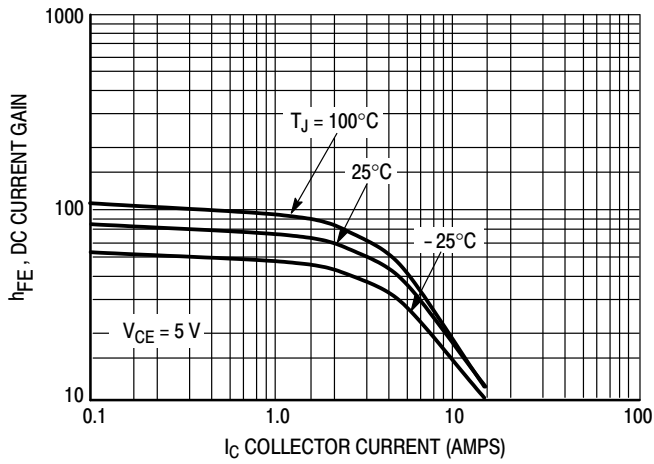

**Figure 5. DC Current Gain,  $V_{CE} = 5$  V**

**NPN MJ21194**

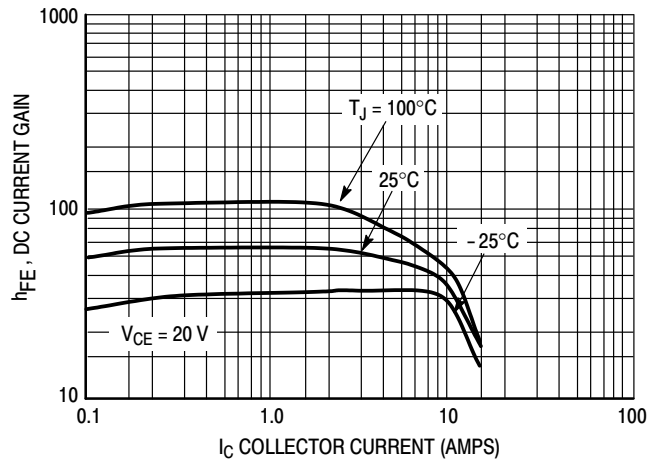

**Figure 6. DC Current Gain,  $V_{CE} = 5$  V**

**PNP MJ21193**

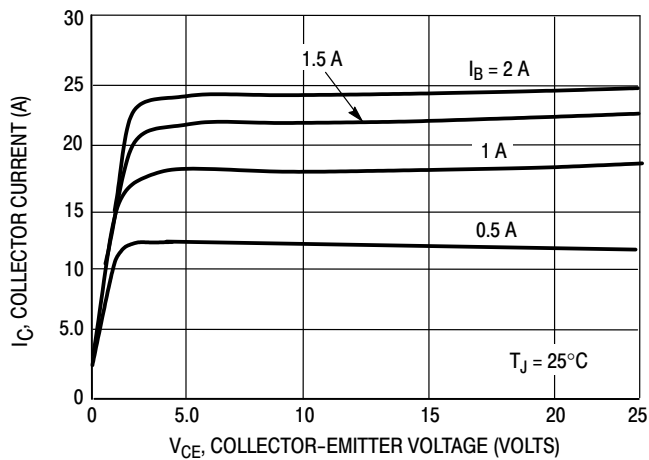

**Figure 7. Typical Output Characteristics**

**NPN MJ21194**

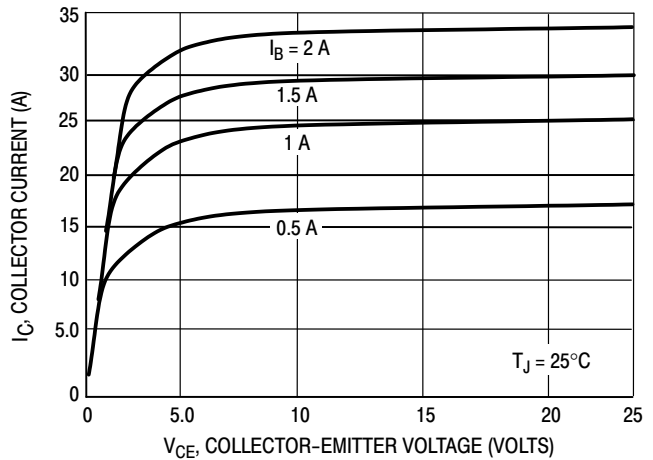

**Figure 8. Typical Output Characteristics**

TYPICAL CHARACTERISTICS

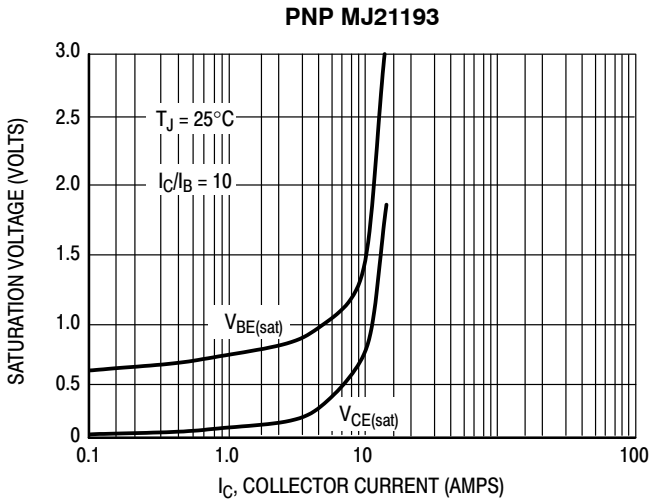

Figure 9. Typical Saturation Voltages

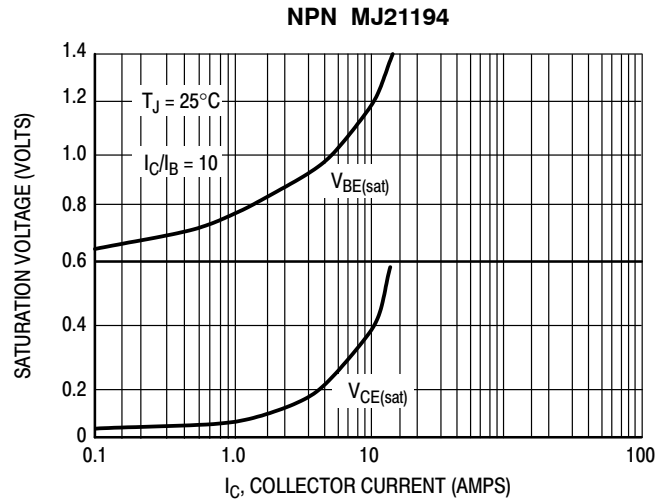

Figure 10. Typical Saturation Voltages

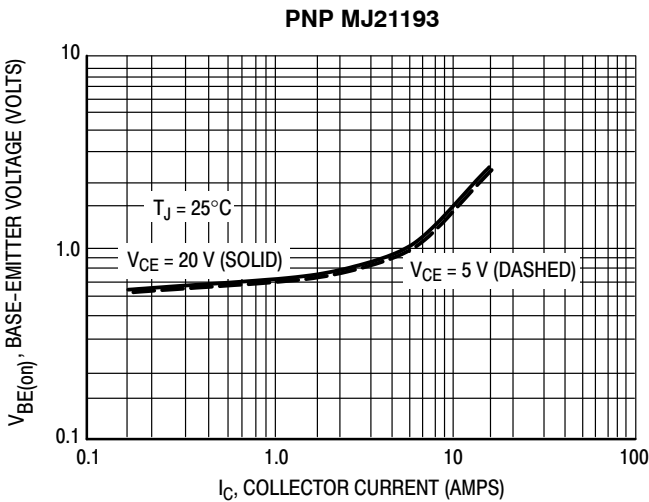

Figure 11. Typical Base-Emitter Voltage

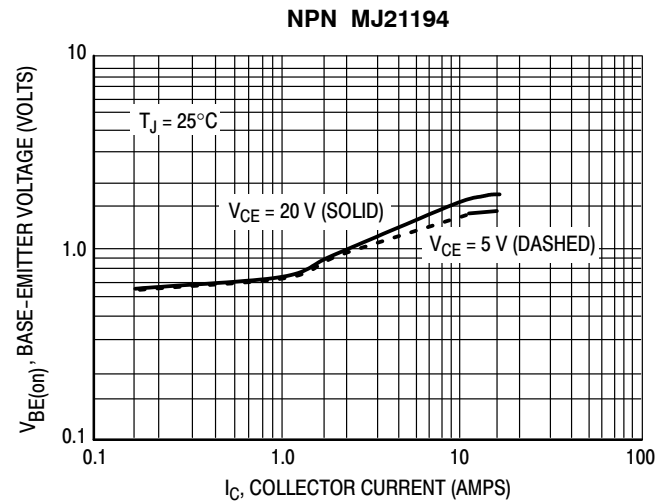

Figure 12. Typical Base-Emitter Voltage

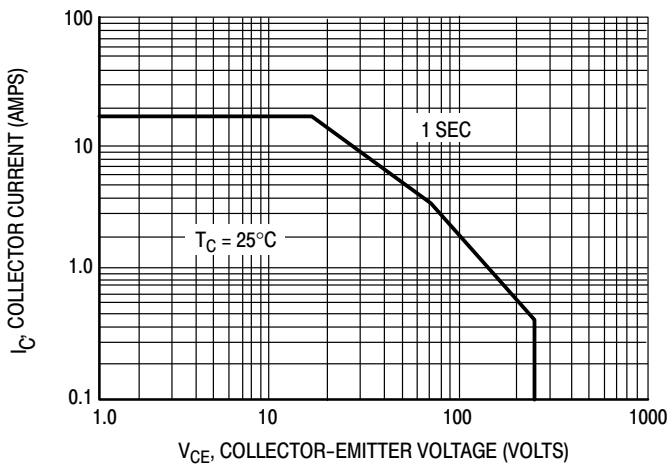

Figure 13. Active Region Safe Operating Area

There are two limitations on the power handling ability of a transistor; average junction temperature and secondary breakdown. Safe operating area curves indicate  $I_C - V_{CE}$  limits of the transistor that must be observed for reliable operation; i.e., the transistor must not be subjected to greater dissipation than the curves indicate.

The data of Figure 13 is based on  $T_{J(pk)} = 200^\circ\text{C}$ ;  $T_C$  is variable depending on conditions. At high case temperatures, thermal limitations will reduce the power than can be handled to values less than the limitations imposed by second breakdown.

# MJ21193, MJ21194

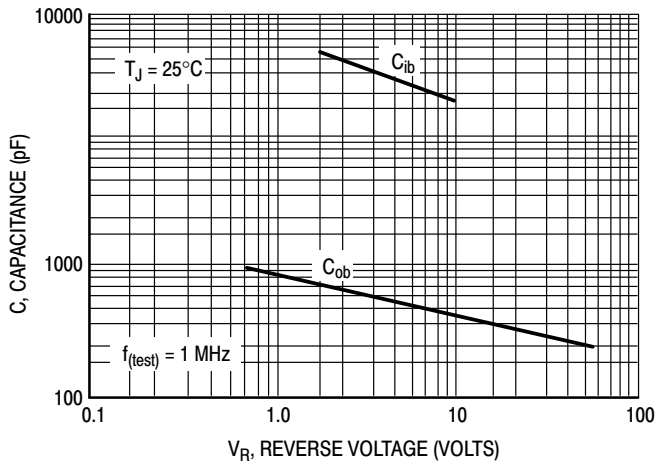

Figure 14. MJ21193 Typical Capacitance

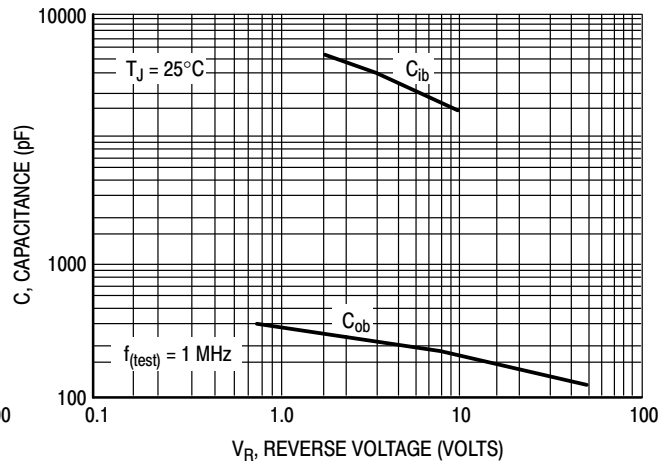

Figure 15. MJ21194 Typical Capacitance

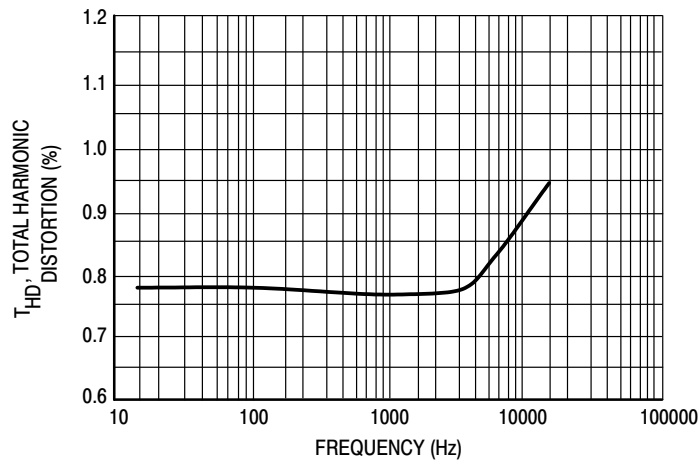

Figure 16. Typical Total Harmonic Distortion

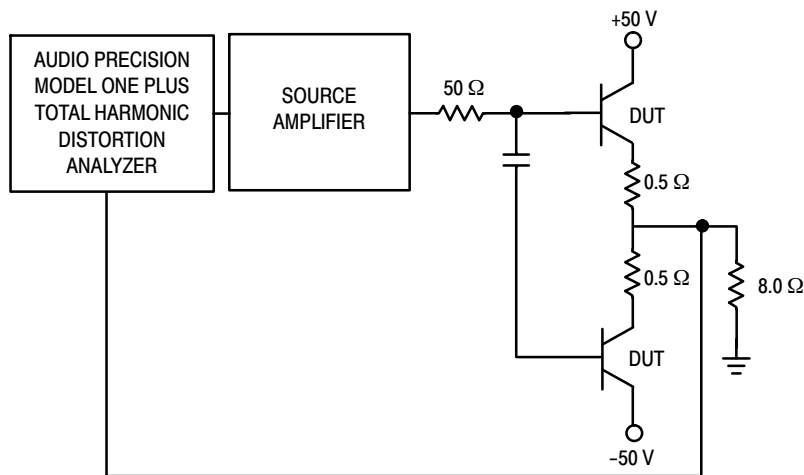

Figure 17. Total Harmonic Distortion Test Circuit

# MJ21193, MJ21194

## PACKAGE DIMENSIONS

TO-204AA (TO-3)

CASE 1-07

ISSUE Z

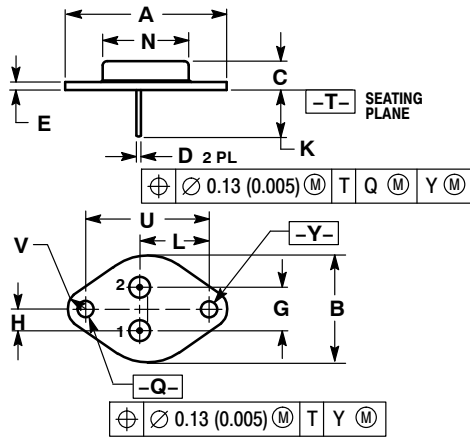

### NOTES:

1. DIMENSIONING AND TOLERANCING PER ANSI Y14.5M, 1982.
2. CONTROLLING DIMENSION: INCH.
3. ALL RULES AND NOTES ASSOCIATED WITH REFERENCED TO-204AA OUTLINE SHALL APPLY.

DIM	INCHES		MILLIMETERS	
	MIN	MAX	MIN	MAX
A	---	1.550 REF	---	39.37 REF
B	---	1.050	---	26.67
C	0.250	0.335	6.35	8.51
D	0.038	0.043	0.97	1.09
E	0.055	0.070	1.40	1.77
G	0.430 BSC		10.92 BSC	
H	0.215 BSC		5.46 BSC	
K	0.440	0.480	11.18	12.19
L	0.665 BSC		16.89 BSC	
N	---	0.830	---	21.08
Q	0.151	0.165	3.84	4.19
U	1.187 BSC		30.15 BSC	
V	0.131	0.188	3.33	4.77

### STYLE 1:

- PIN 1: BASE  
 2: EMITTER  
 CASE: COLLECTOR

ON Semiconductor and are registered trademarks of Semiconductor Components Industries, LLC (SCILLC). SCILLC reserves the right to make changes without further notice to any products herein. SCILLC makes no warranty, representation or guarantee regarding the suitability of its products for any particular purpose, nor does SCILLC assume any liability arising out of the application or use of any product or circuit, and specifically disclaims any and all liability, including without limitation special, consequential or incidental damages. "Typical" parameters which may be provided in SCILLC data sheets and/or specifications can and do vary in different applications and actual performance may vary over time. All operating parameters, including "Typicals" must be validated for each customer application by customer's technical experts. SCILLC does not convey any license under its patent rights nor the rights of others. SCILLC products are not designed, intended, or authorized for use as components in systems intended for surgical implant into the body, or other applications intended to support or sustain life, or for any other application in which the failure of the SCILLC product could create a situation where personal injury or death may occur. Should Buyer purchase or use SCILLC products for any such unintended or unauthorized application, Buyer shall indemnify and hold SCILLC and its officers, employees, subsidiaries, affiliates, and distributors harmless against all claims, costs, damages, and expenses, and reasonable attorney fees arising out of, directly or indirectly, any claim of personal injury or death associated with such unintended or unauthorized use, even if such claim alleges that SCILLC was negligent regarding the design or manufacture of the part. SCILLC is an Equal Opportunity/Affirmative Action Employer. This literature is subject to all applicable copyright laws and is not for resale in any manner.

### PUBLICATION ORDERING INFORMATION

**LITERATURE FULFILLMENT:**  
 Literature Distribution Center for ON Semiconductor  
 P.O. Box 5163, Denver, Colorado 80217 USA  
**Phone:** 303-675-2175 or 800-344-3860 Toll Free USA/Canada  
**Fax:** 303-675-2176 or 800-344-3867 Toll Free USA/Canada  
**Email:** orderlit@onsemi.com

**N. American Technical Support:** 800-282-9855 Toll Free  
 USA/Canada  
**Europe, Middle East and Africa Technical Support:**  
 Phone: 421 33 790 2910  
**Japan Customer Focus Center**  
 Phone: 81-3-5773-3850

**ON Semiconductor Website:** [www.onsemi.com](http://www.onsemi.com)

**Order Literature:** <http://www.onsemi.com/orderlit>

For additional information, please contact your local Sales Representative



## Стандарт Электрон Связь

Мы молодая и активно развивающаяся компания в области поставок электронных компонентов. Мы поставляем электронные компоненты отечественного и импортного производства напрямую от производителей и с крупнейших складов мира.

Благодаря сотрудничеству с мировыми поставщиками мы осуществляем комплексные и плановые поставки широчайшего спектра электронных компонентов.

Собственная эффективная логистика и склад в обеспечивает надежную поставку продукции в точно указанные сроки по всей России.

Мы осуществляем техническую поддержку нашим клиентам и предпродажную проверку качества продукции. На все поставляемые продукты мы предоставляем гарантию .

Осуществляем поставки продукции под контролем ВП МО РФ на предприятия военно-промышленного комплекса России , а также работаем в рамках 275 ФЗ с открытием отдельных счетов в уполномоченном банке. Система менеджмента качества компании соответствует требованиям ГОСТ ISO 9001.

Минимальные сроки поставки, гибкие цены, неограниченный ассортимент и индивидуальный подход к клиентам являются основой для выстраивания долгосрочного и эффективного сотрудничества с предприятиями радиоэлектронной промышленности, предприятиями ВПК и научно-исследовательскими институтами России.

С нами вы становитесь еще успешнее!

### Наши контакты:

**Телефон:** +7 812 627 14 35

**Электронная почта:** [sales@st-electron.ru](mailto:sales@st-electron.ru)

**Адрес:** 198099, Санкт-Петербург,  
Промышленная ул, дом № 19, литера Н,  
помещение 100-Н Офис 331