

## SPDT SWITCH GaAs MMIC

### ■ GENERAL DESCRIPTION

The NJG1647HD3 is a GaAs SPDT switch IC suited for the application of GSM, CDMA and UMTS handsets.

This switch features low distortion, high power handling and low insertion loss.

This device can operate a single bit control signal from +1.3V. This device has the low current consumption mode.

The ultra-small & ultra-thin USB6-D3 package is adopted.

### ■ PACKAGE OUTLINE

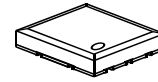

NJG1647HD3

### ■ FEATURES

- Low control voltage 1.3V min.
- Low operation voltage 2.5~+3.6V
- Low distortion IIP3=+70dBm typ. @ P<sub>IN</sub>=24dBm, 2 tone, V<sub>DD</sub>=2.7V  
2nd harmonics=-70dBc max. @ P<sub>IN</sub>=35dBm, f=0.9GHz  
3rd harmonics=-70dBc max. @ P<sub>IN</sub>=35dBm, f=0.9GHz
- Low insertion loss 0.25dB typ. @f=0.9GHz, P<sub>IN</sub>=35dBm, V<sub>DD</sub>=2.7V  
0.30dB typ. @f=1.9GHz, P<sub>IN</sub>=33dBm, V<sub>DD</sub>=2.7V
- Ultra-small & ultra-thin package USB6-D3 (Package size: 2.0x1.8x0.8mm)

### ■ PIN CONFIGURATION

USB6-D3 Type (Top View)

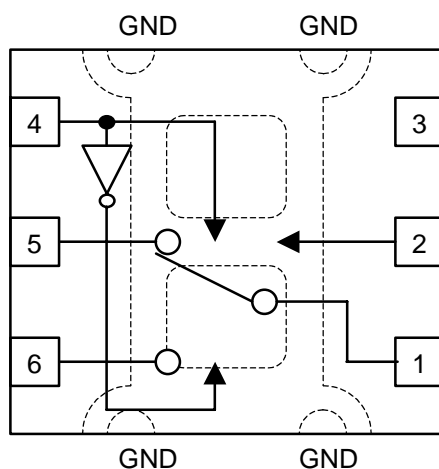

Pin connection

1. PC
2. CTL2 (Option)
3. VDD
4. CTL1
5. P1
6. P2

### ■ TRUTH TABLE

“H”=V<sub>CTL(H)</sub>, “L”=V<sub>CTL(L)</sub>

| CTL1 | Path  |
|------|-------|
| H    | P1-PC |
| L    | P2-PC |

**Option:** CTL2 is the mode switching port. Supplying “L” voltage, this device is operated the low current consumption mode.

NOTE: Please note that any information on this datasheet will be subject to change.

## ■ ABSOLUTE MAXIMUM RATINGS

( $T_a=+25^{\circ}\text{C}$ ,  $Z_s=Z_i=50\Omega$ )

| PARAMETER         | SYMBOL    | CONDITIONS                               | RATINGS  | UNITS              |
|-------------------|-----------|--|----------|--------------------|
| RF Input Power    | $P_{IN}$  | $V_{DD}=2.7\text{V}$ , $CTL2=V_{CTL(H)}$ | 36       | dBm                |
|                   |           | $V_{DD}=2.7\text{V}$ , $CTL2=V_{CTL(L)}$ | 32       |                    |
| Supply Voltage    | $V_{DD}$  | VDD terminal                             | 5.0      | V                  |
| Control Voltage   | $V_{CTL}$ | CTL1, CTL2 terminal                      | 5.0      | V                  |
| Power Dissipation | $P_D$     | on PCB board                             | 270      | mW                 |
| Operating Temp.   | $T_{opr}$ |  | -40~+85  | $^{\circ}\text{C}$ |
| Storage Temp.     | $T_{stg}$ |  | -55~+150 | $^{\circ}\text{C}$ |

## ■ ELECTRICAL CHARACTERISTICS 1

(General conditions:  $T_a=+25^{\circ}\text{C}$ ,  $Z_s=Z_i=50\Omega$ ,  $V_{DD}=2.7\text{V}$ ,  $V_{CTL(L)}=0\text{V}$ ,  $V_{CTL(H)}=1.8\text{V}$ , with application circuit)

| PARAMETERS             | SYMBOL       | CONDITIONS                     | MIN | TYP | MAX | UNITS         |
|------------------------|--------------|--------------------------------|-----|-----|-----|---------------|
| Supply Voltage         | $V_{DD}$     |                                | 2.5 | 2.7 | 3.6 | V             |
| Operating Current1     | $I_{DD1}$    | No RF input, $CTL2=V_{CTL(H)}$ | -   | 300 | 500 | $\mu\text{A}$ |
| Operating Current2     | $I_{DD2}$    | No RF input, $CTL2=V_{CTL(L)}$ | -   | 15  | 50  | $\mu\text{A}$ |
| Control Voltage (LOW)  | $V_{CTL(L)}$ | CTL1, CTL2 Terminal            | 0   | -   | 0.4 | V             |
| Control Voltage (HIGH) | $V_{CTL(H)}$ | CTL1, CTL2 Terminal            | 1.3 | -   | 5.0 | V             |
| Control Current        | $I_{CTL}$    |                                | -   | 5   | 10  | $\mu\text{A}$ |

## ■ ELECTRICAL CHARACTERISTICS 2

(General conditions:  $T_a=+25^{\circ}\text{C}$ ,  $Z_s=Z_l=50\Omega$ ,  $V_{DD}=2.7\text{V}$ ,  $V_{CTL(L)}=0\text{V}$ ,  $V_{CTL(H)}=1.8\text{V}$ , with application circuit)

| PARAMETERS                                      | SYMBOL                 | CONDITIONS  | MIN | TYP  | MAX  | UNITS         |
|---|------------------------|---|-----|------|------|---------------|
| Insertion Loss 1                                | LOSS1                  | $f=0.9\text{GHz}$ , $P_{IN}=35\text{dBm}$                       | -   | 0.25 | 0.45 | dB            |
| Insertion Loss 2                                | LOSS2                  | $f=1.9\text{GHz}$ , $P_{IN}=33\text{dBm}$                       | -   | 0.30 | 0.50 | dB            |
| Isolation 1                                     | ISL1                   | $f=0.9\text{GHz}$ , $P_{IN}=35\text{dBm}$                       | 22  | 25   | -    | dB            |
| Isolation 2                                     | ISL2                   | $f=1.9\text{GHz}$ , $P_{IN}=33\text{dBm}$                       | 17  | 20   | -    | dB            |
| Pin at 0.2dB<br>Compression Point1              | $P_{-0.2\text{dB}}(1)$ | $f=1.9\text{GHz}$   | 34  | -    | -    | dBm           |
| 2 <sup>nd</sup> harmonics1                      | $2f_0(1)$              | $f=0.9\text{GHz}$ , $P_{IN}=35\text{dBm}$                       | -   | -75  | -70  | dBc           |
| 2 <sup>nd</sup> harmonics2                      | $2f_0(2)$              | $f=1.9\text{GHz}$ , $P_{IN}=33\text{dBm}$                       | -   | -75  | -70  | dBc           |
| 3 <sup>rd</sup> harmonics1                      | $3f_0(1)$              | $f=0.9\text{GHz}$ , $P_{IN}=35\text{dBm}$                       | -   | -75  | -70  | dBc           |
| 3 <sup>rd</sup> harmonics2                      | $3f_0(2)$              | $f=1.9\text{GHz}$ , $P_{IN}=33\text{dBm}$                       | -   | -75  | -70  | dBc           |
| Input 3 <sup>rd</sup> order intercept<br>point1 | IIP3(1)                | $f=829+849\text{MHz}$ ,<br>$P_{IN}=24\text{dBm}$ each tone *1   | +65 | +70  | -    | dBm           |
| Input 3 <sup>rd</sup> order intercept<br>point2 | IIP3(2)                | $f=1870+1910\text{MHz}$ ,<br>$P_{IN}=24\text{dBm}$ each tone *1 | +65 | +70  | -    | dBm           |
| VSWR  | VSWR                   | on-state ports, $f=1.9\text{GHz}$                               | -   | 1.2  | 1.4  |               |
| Switching time                                  | $T_{SW}$               |   | -   | 1    | 5    | $\mu\text{s}$ |

\*1: IIP is defined by the following equation:  $IIP3=(3 \times P_{out-IM3})/2+LOSS$

## ■ TERMINAL INFORMATION

| No. | SYMBOL | DESCRIPTION  |
|-----|--------|--|
| 1   | PC     | Common RF port. This PC port is connected to P1 or P2 by logical control voltage of CTL1.<br>In order to block DC bias voltage of internal circuit, an external capacitor is required.           |
| 2   | CTL2   | Control port 2. This terminal is set to +1.3~5.0V of logical high level as usual, and set to +0.0~0.4V of logical low level for the low current consumption mode.                                |
| 3   | VDD    | Supply voltage terminal (+2.5~3.6V). Please place an inductor close to this terminal, and a bypass capacitor between VDD and GND for avoiding RF characteristic degradation.                     |
| 4   | CTL1   | Control port 1. This terminal is set to +1.3~5.0V of logical high level for ON state between PC and P1 ports, and set to +0.0~0.4V of logical low level for ON state between PC and P2 RF ports. |
| 5   | P1     | This port is connected with PC port by control voltage of +1.3~5.0V( $V_{CTL(H)}$ ) to 4th pin. An external capacitor is required to block the DC bias voltage of internal circuit.              |
| 6   | P2     | This port is connected to PC port by control voltage of +0.0~0.4V( $V_{CTL(L)}$ ) to 4th pin. An external capacitor is required to block the DC bias voltage of internal circuit.                |
| GND | GND    | Ground terminal. Please connect this terminal with ground plane as close as possible for good RF performance.  |

■ ELECTRICAL CHARACTERISTICS (With Application circuit, Loss of external circuit are excluded)

**Loss, ISL vs Frequency**

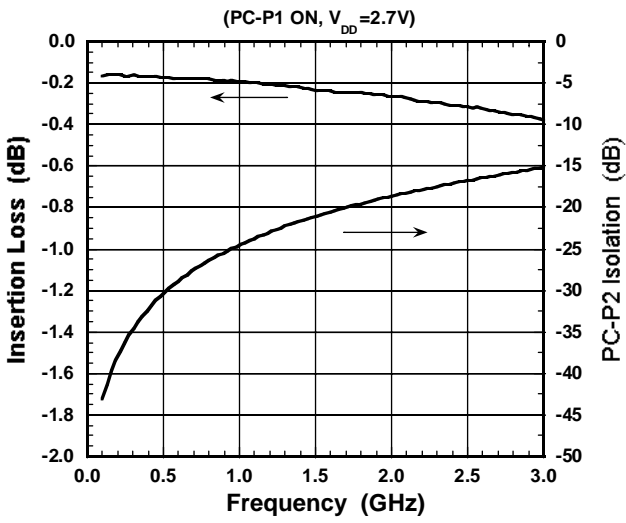

**Loss, ISL vs Frequency**

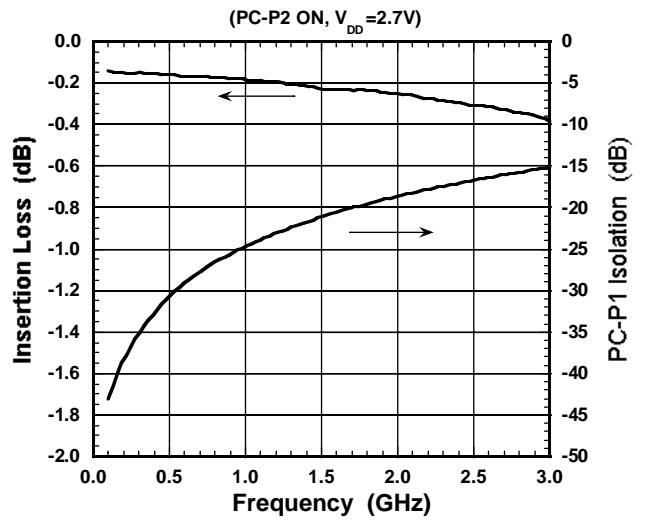

**VSWR vs Frequency**

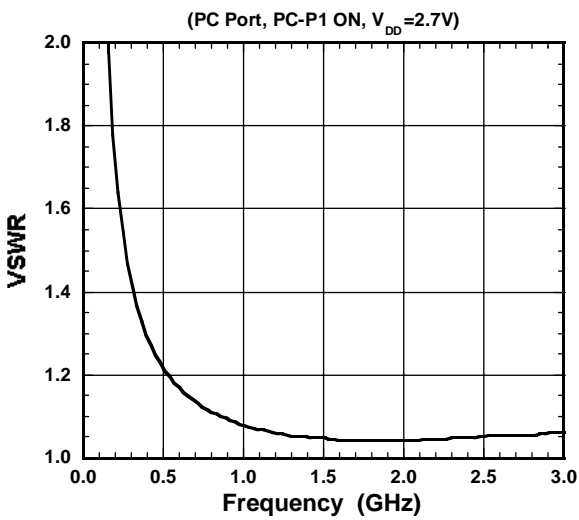

**VSWR vs Frequency**

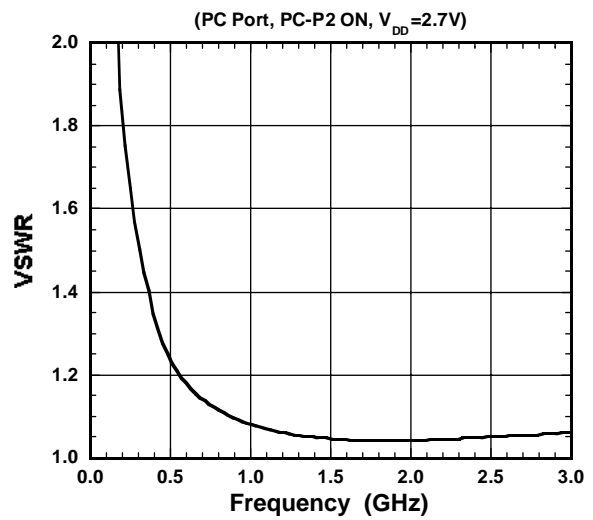

■ ELECTRICAL CHARACTERISTICS (With Application circuit, Loss of external circuit are excluded)

**Output Power,  $I_{DD}$  vs Input Power**  
( $f=0.9\text{GHz}$ , P1-PC ON, CTL2=1.8V)

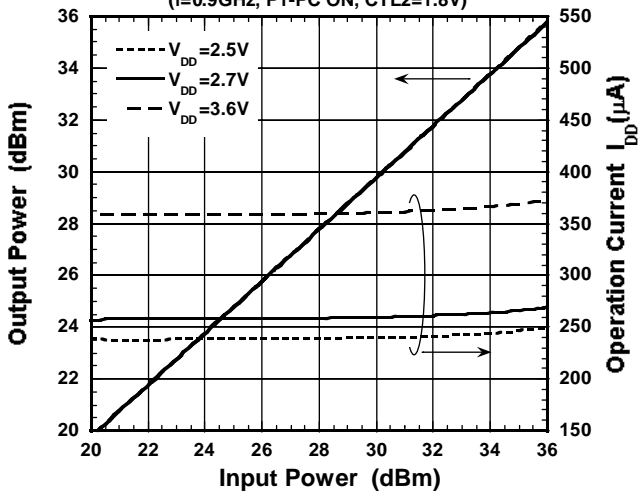

**Output Power,  $I_{DD}$  vs Input Power**  
( $f=1.9\text{GHz}$ , P1-PC ON, CTL2=1.8V)

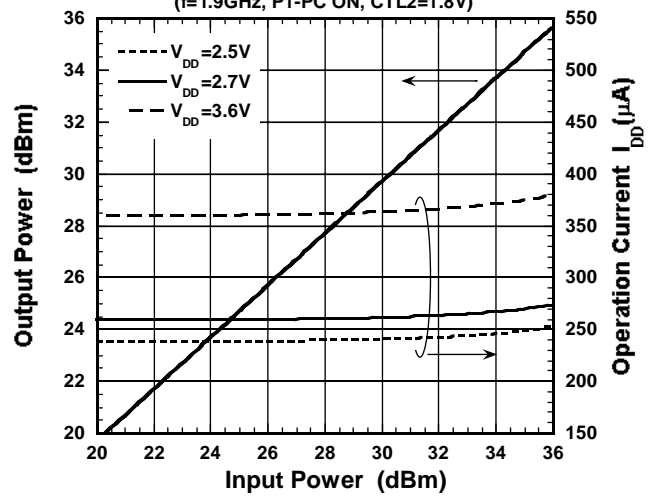

**Loss, ISL vs Input Power**  
( $f=0.9\text{GHz}$ , P1-PC ON, CTL2=1.8V)

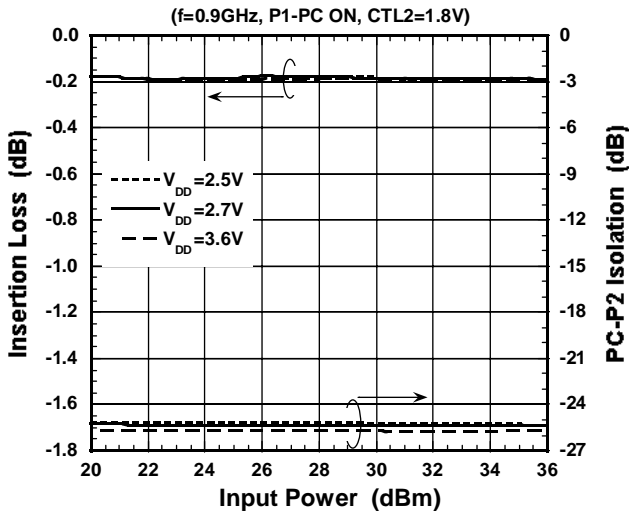

**Loss, ISL vs Input Power**  
( $f=1.9\text{GHz}$ , P1-PC ON, CTL2=1.8V)

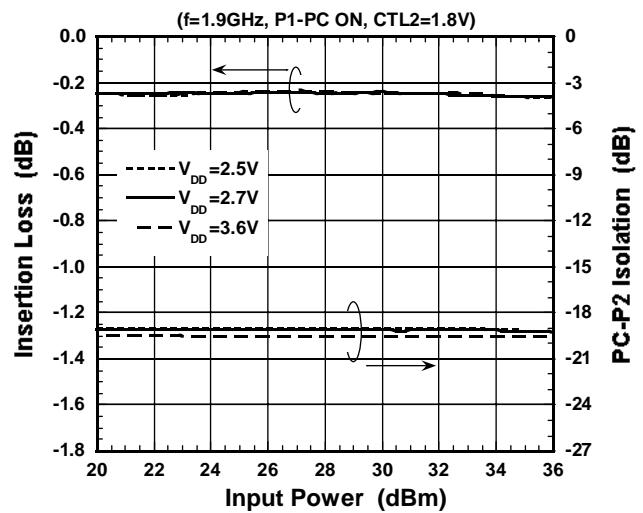

**Harmonics vs Input Power**  
( $f=0.9\text{GHz}$ , P1-PC ON, CTL2=1.8V)

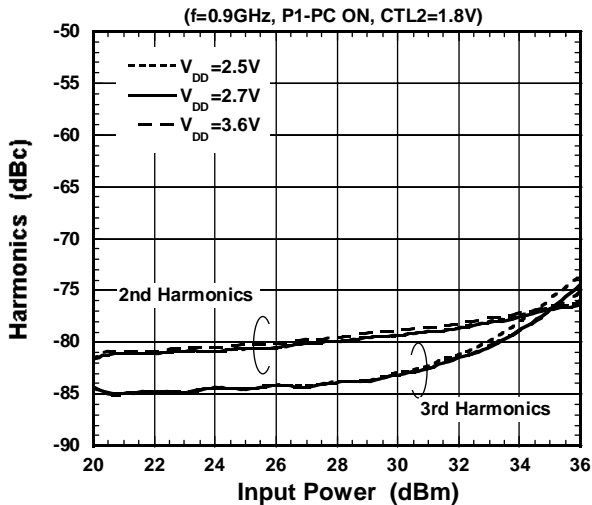

**Harmonics vs Input Power**  
( $f=1.9\text{GHz}$ , P1-PC ON, CTL2=1.8V)

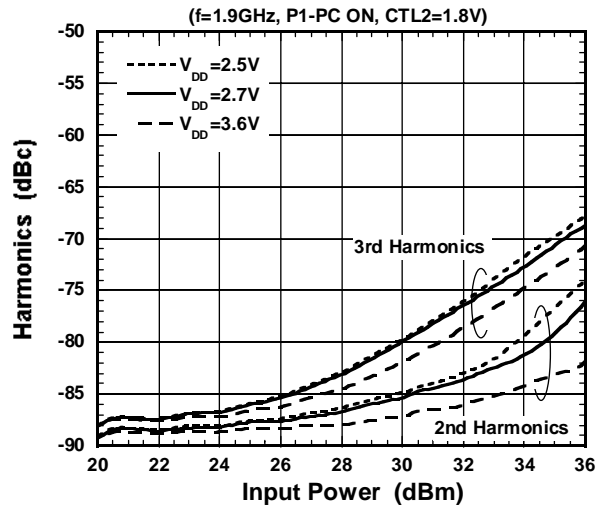

## ■ ELECTRICAL CHARACTERISTICS (With Application circuit, Loss of external circuit are excluded)

### Output Power, IM3 vs Input Power

(f=829MHz+849MHz, P1-PC ON,  $V_{DD}=2.7V$ )

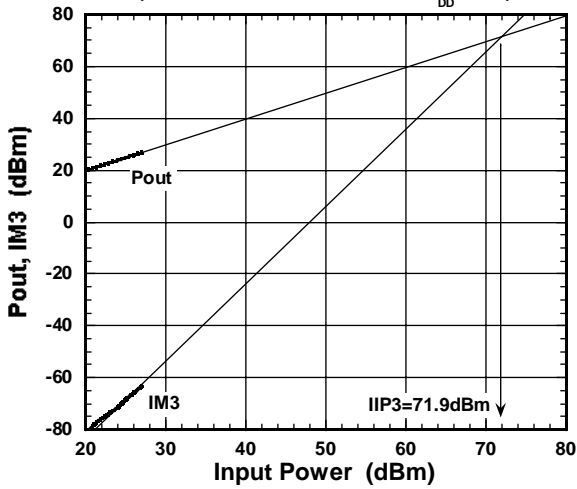

### Output Power, IM3 vs Input Power

(f=1870MHz+1910MHz, P1-PC ON,  $V_{DD}=2.7V$ )

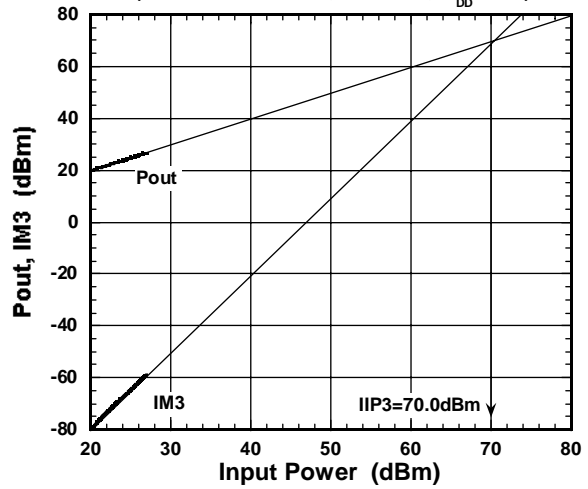

### IIP3 vs Input Power

(f=829MHz+849MHz, P1-PC ON, CTL2=1.8V)

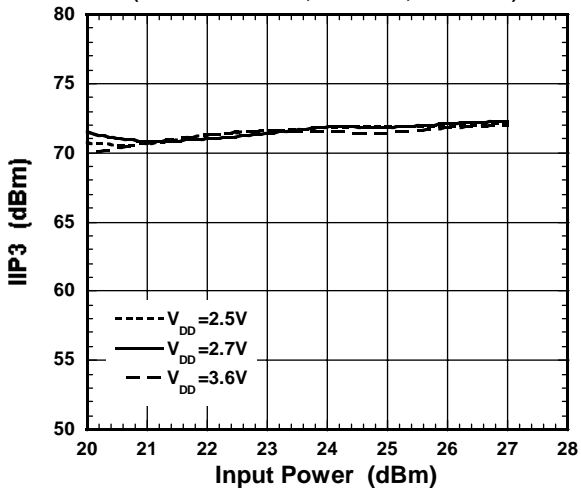

### IIP3 vs Input Power

(f=1870MHz+1910MHz, P1-PC ON, CTL2=1.8V)

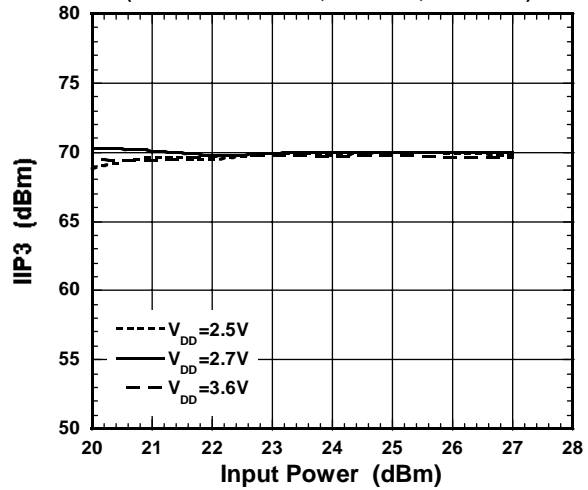

## ■ ELECTRICAL CHARACTERISTICS (With Application circuit, Loss of external circuit are excluded)

### DC Current vs Ambient Temperature

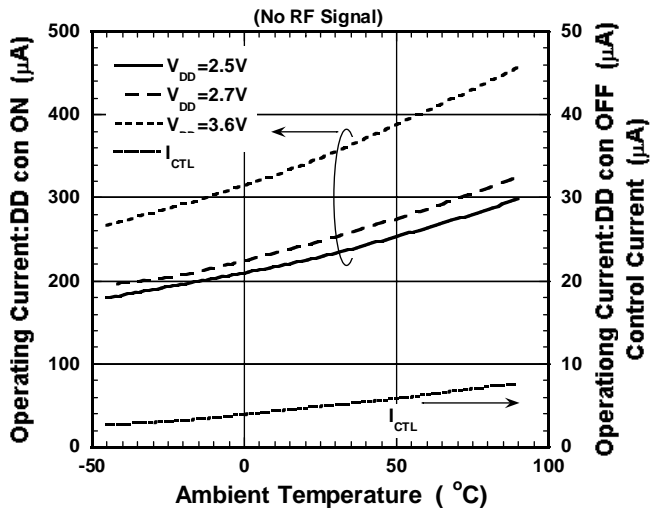

### Switching Time vs Ambient Temperature

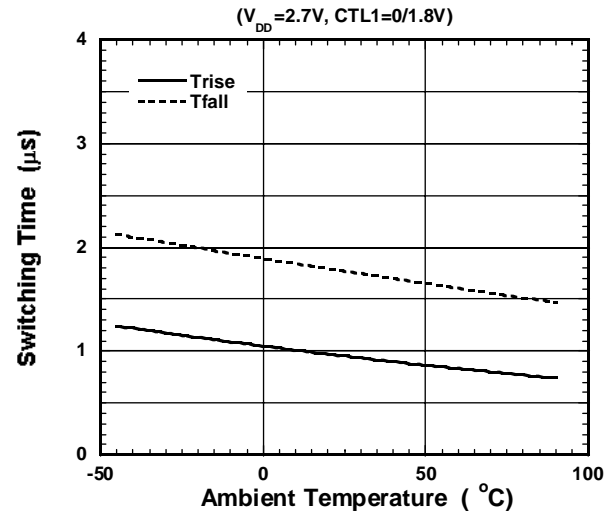

### Loss, ISL vs Ambient Temperature

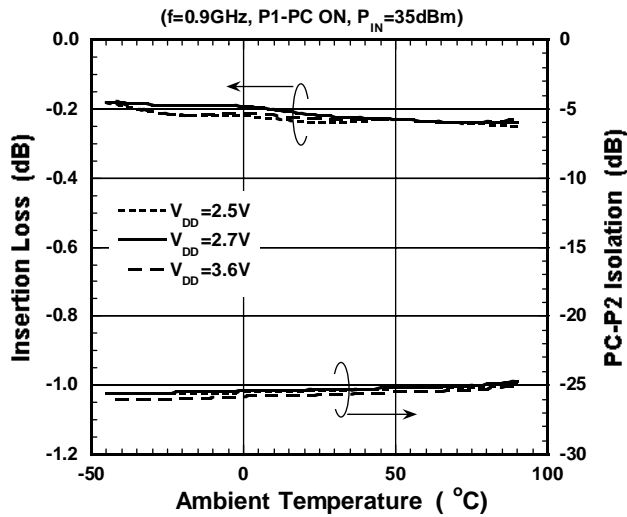

### Loss, ISL vs Ambient Temperature

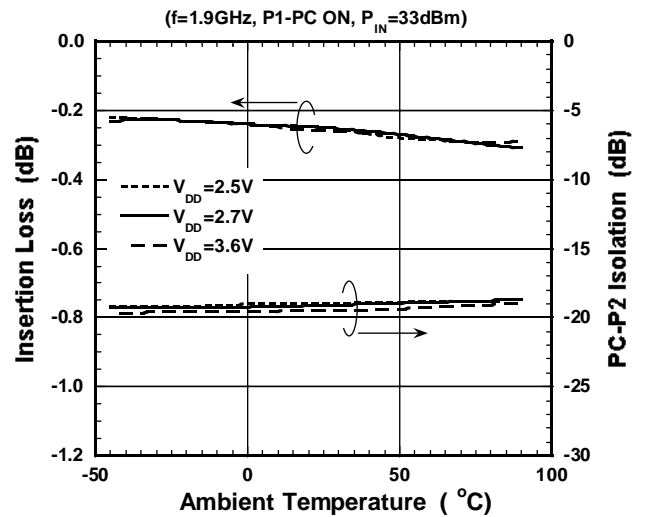



## ■ ELECTRICAL CHARACTERISTICS (With Application circuit, Loss of external circuit are excluded)

### 2nd Harmonics vs Ambient Temperature

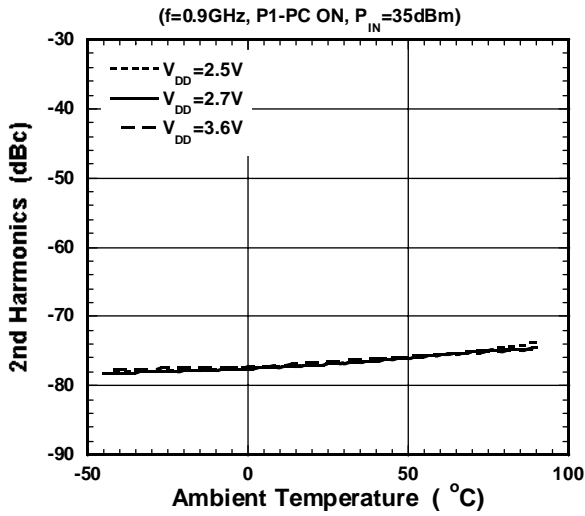

### 2nd Harmonics vs Ambient Temperature

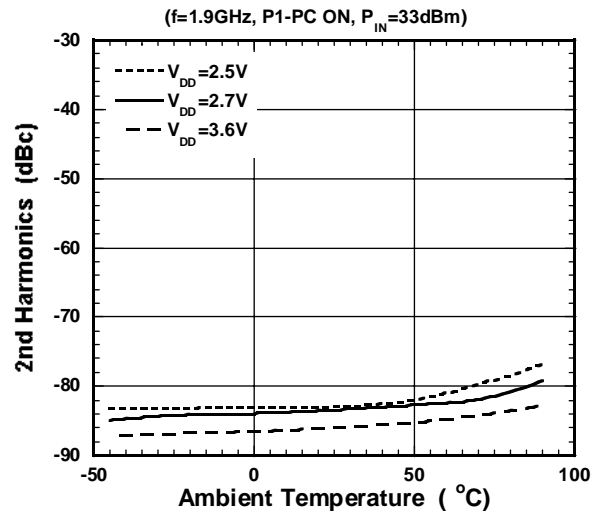

### IIP3 vs Ambient Temperature

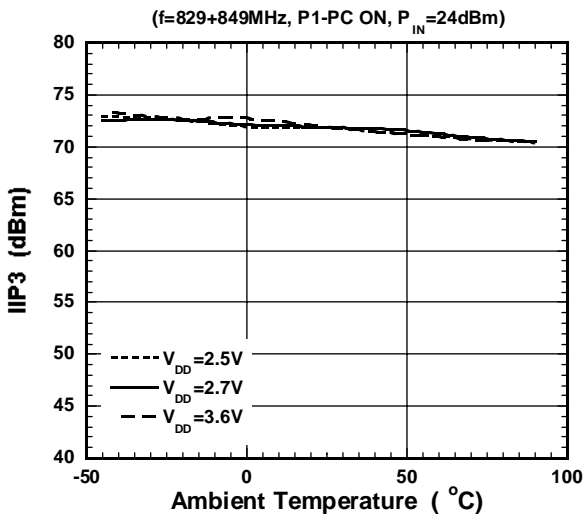

### IIP3 vs Ambient Temperature

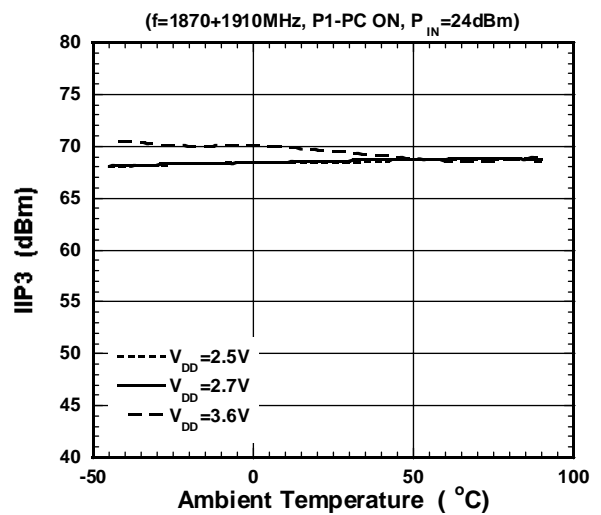

### 3rd Harmonics vs Ambient Temperature

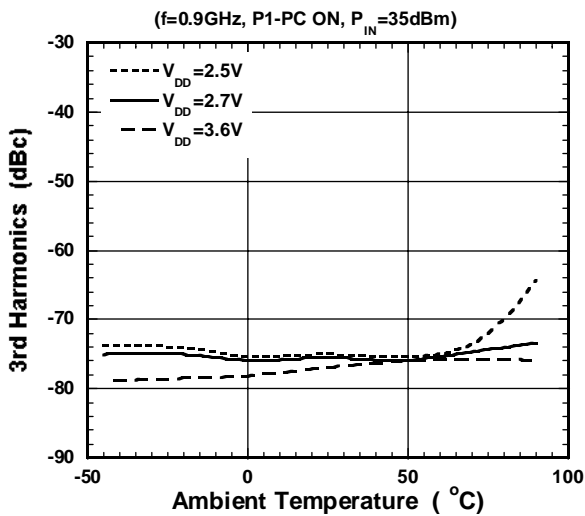

### 3rd Harmonics vs Ambient Temperature

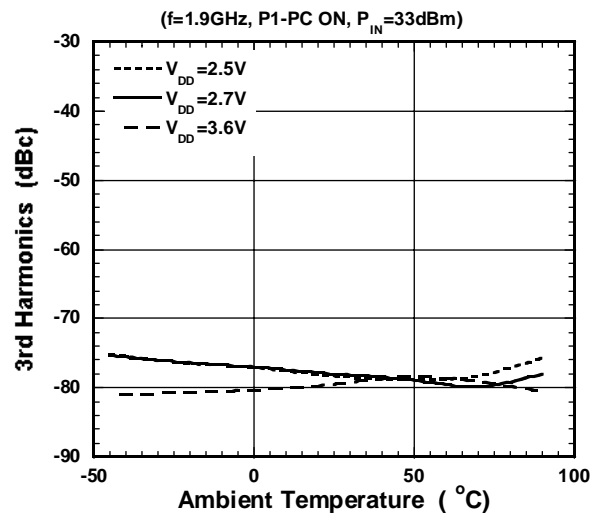

## APPLICATION CIRCUIT

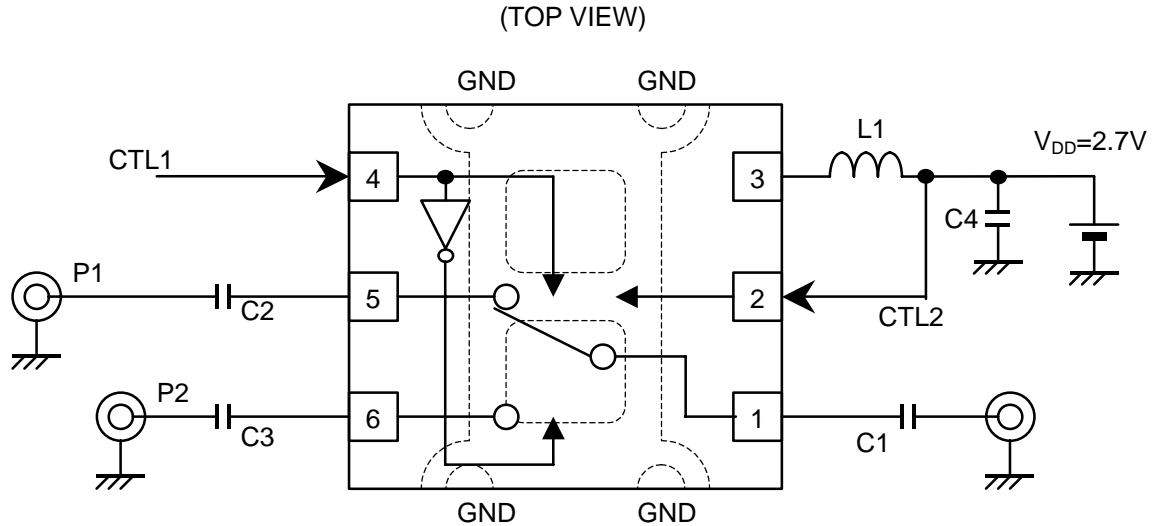

## PARTS LIST

| No.   | Parameters | Note                  |
|-------|------------|-----------------------|
| C1~C3 | 56pF       | Murata MFG<br>(GRM15) |
| C4    | 1000pF     |                       |
| L1    | 82nH       | TDK (MLG0603)         |

## TEST PCB LAYOUT

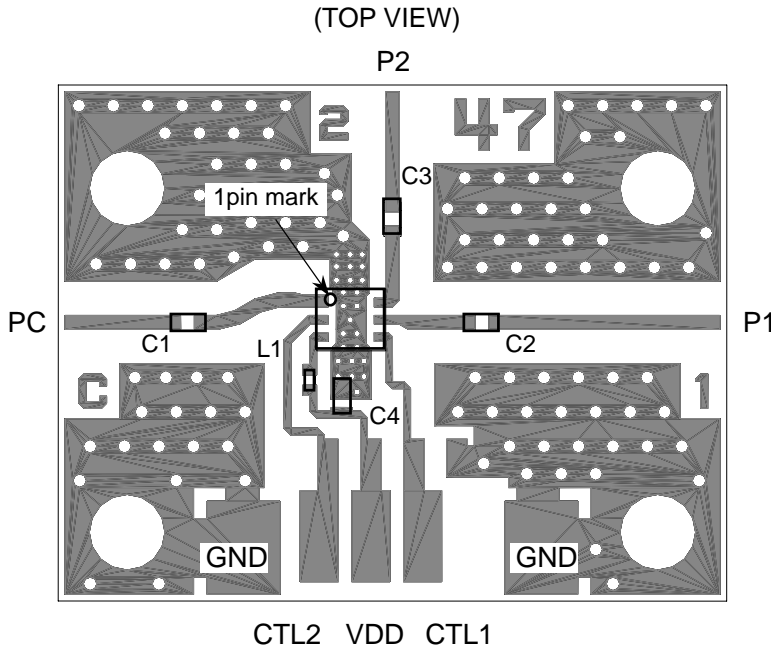

PCB SIZE=19.4x15.0mm  
 PCB: FR-4, t=0.2mm  
 CAPACITOR: size 1005  
 INDUCTOR: size 0603  
 Strip Line Width=0.4mm( $Z_0=50\Omega$ )

### Losses of PCB

(Connector and DC blocking Capacitor losses are included)

| Frequency<br>(GHz) | Loss (dB) |       |
|--------------------|-----------|-------|
|                    | PC-P1     | PC-P2 |
| 0.9                | 0.23      | 0.21  |
| 1.9                | 0.33      | 0.30  |

## PRECAUTIONS

- [1] The DC blocking capacitors have to be placed at RF terminal of PC, P1 and P2.
- [2] To control the influence on the RF performance, the terminal of VDD should be connected with ground through the inductor L1 and the bypass capacitor C4.
- [3] For good RF performance, the ground terminals must be placed possibly close to ground plane of substrate, and through holes for GND should be placed near by the pin connection.

## ■ PACKAGE OUTLINE (USB6-D3)

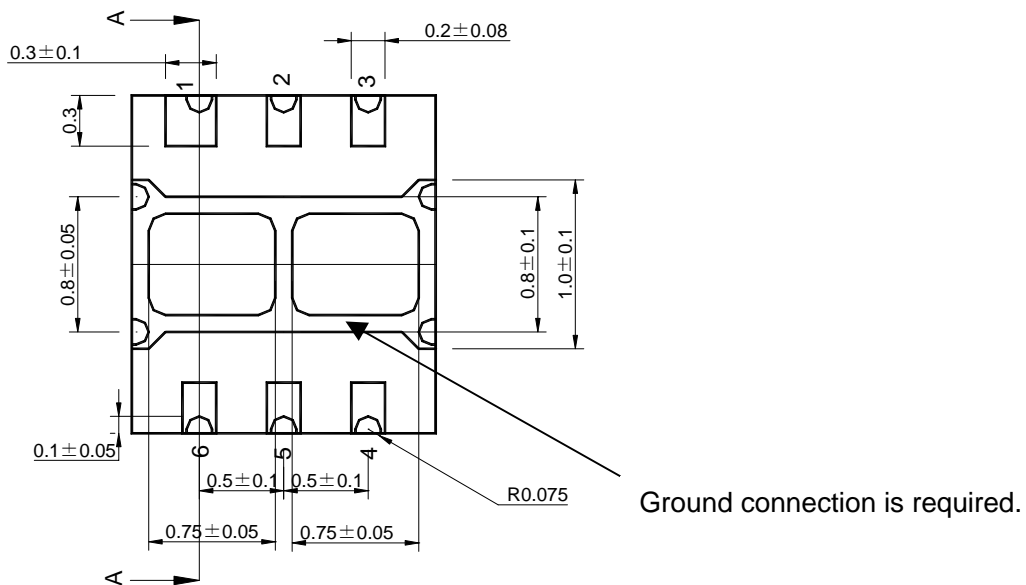
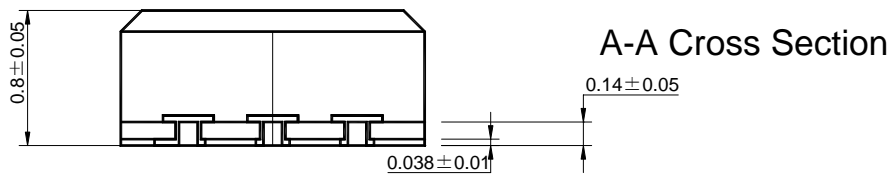
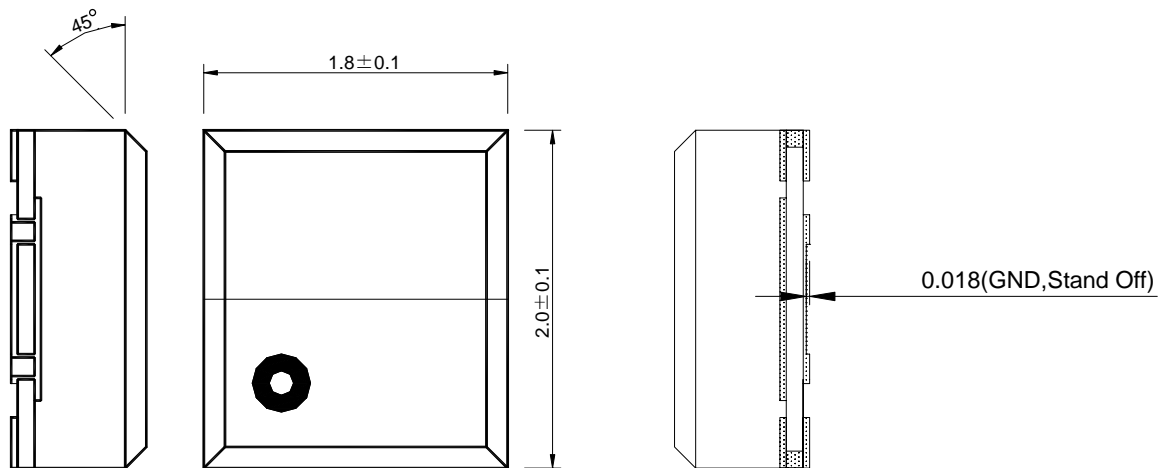

### Cautions on using this product

This product contains Gallium-Arsenide (GaAs) which is a harmful material.

- Do NOT eat or put into mouth.
- Do NOT dispose in fire or break up this product.
- Do NOT chemically make gas or powder with this product.
- To waste this product, please obey the relating law of your country.

### [CAUTION]

The specifications on this databook are only given for information, without any guarantee as regards either mistakes or omissions. The application circuits in this databook are described only to show representative usages of the product and not intended for the guarantee or permission of any right including the industrial rights.

This product may be damaged with electric static discharge (ESD) or spike voltage. Please handle with care to avoid these damages.



## Стандарт Электрон Связь

Мы молодая и активно развивающаяся компания в области поставок электронных компонентов. Мы поставляем электронные компоненты отечественного и импортного производства напрямую от производителей и с крупнейших складов мира.

Благодаря сотрудничеству с мировыми поставщиками мы осуществляем комплексные и плановые поставки широчайшего спектра электронных компонентов.

Собственная эффективная логистика и склад в обеспечивает надежную поставку продукции в точно указанные сроки по всей России.

Мы осуществляем техническую поддержку нашим клиентам и предпродажную проверку качества продукции. На все поставляемые продукты мы предоставляем гарантию .

Осуществляем поставки продукции под контролем ВП МО РФ на предприятия военно-промышленного комплекса России , а также работаем в рамках 275 ФЗ с открытием отдельных счетов в уполномоченном банке. Система менеджмента качества компании соответствует требованиям ГОСТ ISO 9001.

Минимальные сроки поставки, гибкие цены, неограниченный ассортимент и индивидуальный подход к клиентам являются основой для выстраивания долгосрочного и эффективного сотрудничества с предприятиями радиоэлектронной промышленности, предприятиями ВПК и научно-исследовательскими институтами России.

С нами вы становитесь еще успешнее!

### Наши контакты:

**Телефон:** +7 812 627 14 35

**Электронная почта:** [sales@st-electron.ru](mailto:sales@st-electron.ru)

**Адрес:** 198099, Санкт-Петербург,  
Промышленная ул, дом № 19, литера Н,  
помещение 100-Н Офис 331