

Dual 12-/10-/8-Bit SPI V_{OUT} DACs with 10ppm/°C Reference

FEATURES

- **Integrated Precision Reference**
2.5V Full-Scale 10ppm/°C (LTC2632-L)
4.096V Full-Scale 10ppm/°C (LTC2632-H)
- **Maximum INL Error: ±1.5LSB (LTC2632A-12)**
- Low Noise: 0.75mV_{P-P} 0.1Hz to 200kHz
- Guaranteed Monotonic -40°C to 125°C Automotive Temperature Range
- Selectable Internal or External Reference
- 2.7V to 5.5V Supply Range (LTC2632-L)
- Low Power Operation 0.4mA at 3V
- Power-On-Reset to Zero-Scale/Mid-Scale
- Double-Buffered Data Latches
- 8-Lead ThinSOT™ Package

APPLICATIONS

- Mobile Communications
- Process Control and Industrial Automation
- Automatic Test Equipment
- Portable Equipment
- Automotive

DESCRIPTION

The LTC[®]2632 is a family of dual 12-, 10-, and 8-bit voltage-output DACs with an integrated, high-accuracy, low-drift reference in an 8-lead TSOT-23 package. It has rail-to-rail output buffers and is guaranteed monotonic.

The LTC2632-L has a full-scale output of 2.5V, and operates from a single 2.7V to 5.5V supply. The LTC2632-H has a full-scale output of 4.096V, and operates from a 4.5V to 5.5V supply. Each DAC can also operate with an external reference, which sets the full-scale output to the external reference voltage.

These DACs communicate via a simple SPI/MICROWIRE compatible 3-wire serial interface which operates at clock rates up to 50MHz. The LTC2632 incorporates a power-on reset circuit. Options are available for reset to zero-scale or reset to mid-scale in internal reference mode, or reset to mid-scale in external reference mode after power-up.

All registered trademarks and trademarks are the property of their respective owners. Protected by U.S. patents, including 5396245, 5859606, 6891433, and 6937178.

BLOCK DIAGRAM

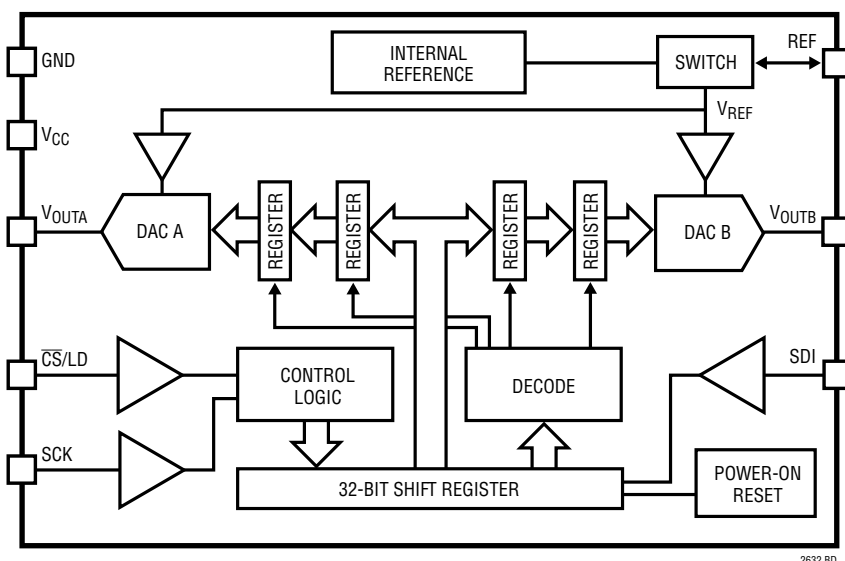

Integral Nonlinearity (LTC2632A-LZ12)

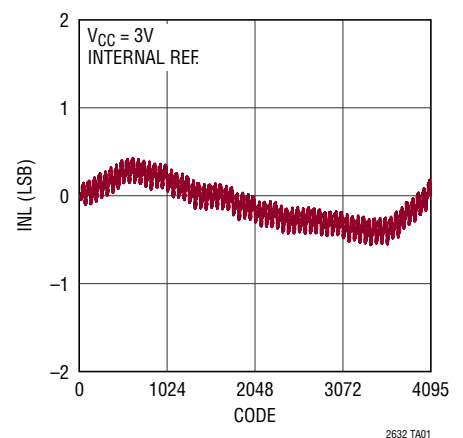

ABSOLUTE MAXIMUM RATINGS

(Notes 1, 2)

Supply Voltage (V_{CC})	-0.3V to 6V
SCK, SDI	-0.3V to 6V
\overline{CS}/LD (Note 10).....	-0.3V to Min ($V_{CC} + 0.3V, 6V$)
V_{OUTA}, V_{OUTB}	-0.3V to Min ($V_{CC} + 0.3V, 6V$)
REF	-0.3V to Min ($V_{CC} + 0.3V, 6V$)
Operating Temperature Range	
LTC2632C	0°C to 70°C
LTC2632H.....	-40°C to 125°C
Maximum Junction Temperature	150°C
Storage Temperature Range	-65°C to 150°C
Lead Temperature (Soldering, 10 sec).....	300°C

PIN CONFIGURATION

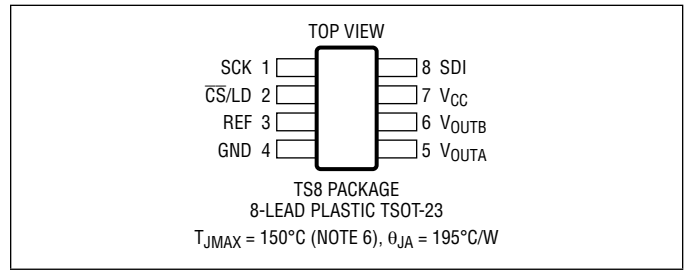

ORDER INFORMATION

LTC2632 A C TS8 -L Z 12 #TRM PBF

LEAD FREE DESIGNATOR

TAPE AND REEL

TR = 2,500-Piece Tape and Reel
TRM = 500-Piece Tape and Reel

RESOLUTION

12 = 12-Bit
10 = 10-Bit
8 = 8-Bit

POWER-ON RESET

I = Reset to Mid-Scale in Internal Reference Mode
X = Reset to Mid-Scale in External Reference Mode (2632-L Only)
Z = Reset to Zero-Scale in Internal Reference Mode

FULL-SCALE VOLTAGE, INTERNAL REFERENCE MODE

L = 2.5V
H = 4.096V

PACKAGE TYPE

TS8 = 8-Lead Plastic TSOT-23

TEMPERATURE GRADE

C = Commercial Temperature Range (0°C to 70°C)
H = Automotive Temperature Range (-40°C to 125°C)

ELECTRICAL GRADE (OPTIONAL)

A = ± 1.5 LSB Maximum INL (12-Bit)

PRODUCT PART NUMBER

Contact the factory for parts specified with wider operating temperature ranges.
Contact the factory for information on lead based finish parts.

[Tape and reel specifications](#). Some packages are available in 500 unit reels through designated sales channels with #TRMPBF suffix.

PRODUCT SELECTION GUIDE

PART NUMBER	PART MARKING*	V _{FS} WITH INTERNAL REFERENCE	POWER-ON RESET TO CODE	POWER-ON REFERENCE MODE	RESOLUTION	V _{CC}	MAXIMUM INL
LTC2632A-LI12	LTFSJ	2.5V • (4095/4096)	Mid-Scale	Internal	12-Bit	2.7V to 5.5V	±1.5LSB
LTC2632A-LX12	LTFSH	2.5V • (4095/4096)	Mid-Scale	External	12-Bit	2.7V to 5.5V	±1.5LSB
LTC2632A-LZ12	LTFSG	2.5V • (4095/4096)	Zero	Internal	12-Bit	2.7V to 5.5V	±1.5LSB
LTC2632A-HI12	LTFSM	4.096V • (4095/4096)	Mid-Scale	Internal	12-Bit	4.5V to 5.5V	±1.5LSB
LTC2632A-HZ12	LTFSK	4.096V • (4095/4096)	Zero	Internal	12-Bit	4.5V to 5.5V	±1.5LSB
LTC2632-LI12	LTFSJ	2.5V • (4095/4096)	Mid-Scale	Internal	12-Bit	2.7V to 5.5V	±2.5LSB
LTC2632-LI10	LTFSQ	2.5V • (1023/1024)	Mid-Scale	Internal	10-Bit	2.7V to 5.5V	±1LSB
LTC2632-LI8	LTFSW	2.5V • (255/256)	Mid-Scale	Internal	8-Bit	2.7V to 5.5V	±0.5LSB
LTC2632-LX12	LTFSH	2.5V • (4095/4096)	Mid-Scale	External	12-Bit	2.7V to 5.5V	±2.5LSB
LTC2632-LX10	LTFSQ	2.5V • (1023/1024)	Mid-Scale	External	10-Bit	2.7V to 5.5V	±1LSB
LTC2632-LX8	LTFSV	2.5V • (255/256)	Mid-Scale	External	8-Bit	2.7V to 5.5V	±0.5LSB
LTC2632-LZ12	LTFSG	2.5V • (4095/4096)	Zero	Internal	12-Bit	2.7V to 5.5V	±2.5LSB
LTC2632-LZ10	LTFSN	2.5V • (1023/1024)	Zero	Internal	10-Bit	2.7V to 5.5V	±1LSB
LTC2632-LZ8	LTFSK	2.5V • (255/256)	Zero	Internal	8-Bit	2.7V to 5.5V	±0.5LSB
LTC2632-HI12	LTFSM	4.096V • (4095/4096)	Mid-Scale	Internal	12-Bit	4.5V to 5.5V	±2.5LSB
LTC2632-HI10	LTFSQ	4.096V • (1023/1024)	Mid-Scale	Internal	10-Bit	4.5V to 5.5V	±1LSB
LTC2632-HI8	LTFSY	4.096V • (255/256)	Mid-Scale	Internal	8-Bit	4.5V to 5.5V	±0.5LSB
LTC2632-HZ12	LTFSK	4.096V • (4095/4096)	Zero	Internal	12-Bit	4.5V to 5.5V	±2.5LSB
LTC2632-HZ10	LTFSR	4.096V • (1023/1024)	Zero	Internal	10-Bit	4.5V to 5.5V	±1LSB
LTC2632-HZ8	LTFSX	4.096V • (255/256)	Zero	Internal	8-Bit	4.5V to 5.5V	±0.5LSB

* The temperature grade is identified by a label on the shipping container.
Above options are available in an 8-lead TSOT package (LTC2632xTS8).

ELECTRICAL CHARACTERISTICS

The ● denotes the specifications which apply over the full operating temperature range, otherwise specifications are at $T_A = 25^\circ\text{C}$. $V_{CC} = 2.7\text{V}$ to 5.5V , V_{OUT} unloaded unless otherwise specified.

LTC2632-LI12/-LI10/-LI8/-LX12/-LX10/-LX8/-LZ12/-LZ10/-LZ8, LTC2632A-LI12/-LX12/-LZ12 ($V_{FS} = 2.5\text{V}$)

SYMBOL	PARAMETER	CONDITIONS	LTC2632-8			LTC2632-10			LTC2632-12			LTC2632A-12			UNITS
			MIN	TYP	MAX	MIN	TYP	MAX	MIN	TYP	MAX	MIN	TYP	MAX	
DC Performance															
	Resolution		●	8		10		12		12		12		Bits	
	Monotonicity	$V_{CC} = 3\text{V}$, Internal Ref. (Note 3)	●	8		10		12		12		12		Bits	
DNL	Differential Nonlinearity	$V_{CC} = 3\text{V}$, Internal Ref. (Note 3)	●		± 0.5		± 0.5		± 1		± 1		± 1	LSB	
INL	Integral Nonlinearity	$V_{CC} = 3\text{V}$, Internal Ref. (Note 3)	●	± 0.05	± 0.5		± 0.2	± 1		± 1	± 2.5		± 0.5	± 1.5	LSB
ZSE	Zero-Scale Error	$V_{CC} = 3\text{V}$, Internal Ref., Code = 0	●	0.5	5		0.5	5		0.5	5		0.5	5	mV
V_{OS}	Offset Error	$V_{CC} = 3\text{V}$, Internal Ref. (Note 4)	●	± 0.5	± 5		± 0.5	± 5		± 0.5	± 5		± 0.5	± 5	mV
V_{OSTC}	V_{OS} Temperature Coefficient	$V_{CC} = 3\text{V}$, Internal Ref.		± 10		± 10		± 10		± 10		± 10		± 10	$\mu\text{V}/^\circ\text{C}$
GE	Gain Error	$V_{CC} = 3\text{V}$, Internal Ref.	●	0.2	0.8		0.2	0.8		0.2	0.8		0.2	0.8	%FSR
GE_{TC}	Gain Temperature Coefficient	$V_{CC} = 3\text{V}$, Internal Ref. (Note 9) C-Grade H-Grade		10 10		10 10		10 10		10 10		10 10		10 10	ppm/ $^\circ\text{C}$ ppm/ $^\circ\text{C}$
	Load Regulation	Internal Ref., Mid-Scale, $V_{CC} = 3\text{V} \pm 10\%$, $-5\text{mA} \leq I_{OUT} \leq 5\text{mA}$ $V_{CC} = 5\text{V} \pm 10\%$, $-10\text{mA} \leq I_{OUT} \leq 10\text{mA}$	● ●	0.009 0.009	0.016 0.016		0.035 0.035	0.064 0.064		0.14 0.14	0.256 0.256		0.14 0.14	0.256 0.256	LSB/mA LSB/mA
R_{OUT}	DC Output Impedance	Internal Ref., Mid-Scale, $V_{CC} = 3\text{V} \pm 10\%$, $-5\text{mA} \leq I_{OUT} \leq 5\text{mA}$ $V_{CC} = 5\text{V} \pm 10\%$, $-10\text{mA} \leq I_{OUT} \leq 10\text{mA}$	● ●	0.09 0.09	0.156 0.156		0.09 0.09	0.156 0.156		0.09 0.09	0.156 0.156		0.09 0.09	0.156 0.156	Ω Ω

SYMBOL	PARAMETER	CONDITIONS	MIN	TYP	MAX	UNITS
V_{OUT}	DAC Output Span	External Reference Internal Reference		0 to V_{REF} 0 to 2.5		V V
PSR	Power Supply Rejection	$V_{CC} = 3\text{V} \pm 10\%$ or $5\text{V} \pm 10\%$		-80		dB
I_{SC}	Short-Circuit Output Current (Note 5) Sinking Sourcing	$V_{FS} = V_{CC} = 5.5\text{V}$ Zero-Scale; V_{OUT} Shorted to V_{CC} Full-Scale; V_{OUT} Shorted to GND	● ●	27 -28	48 -48	mA mA

Power Supply

V_{CC}	Positive Supply Voltage	For Specified Performance	●	2.7	5.5	V
I_{CC}	Supply Current (Note 6)	$V_{CC} = 3\text{V}$, $V_{REF} = 2.5\text{V}$, External Reference $V_{CC} = 3\text{V}$, Internal Reference $V_{CC} = 5\text{V}$, $V_{REF} = 2.5\text{V}$, External Reference $V_{CC} = 5\text{V}$, Internal Reference	● ● ● ●	0.3 0.4 0.3 0.4	0.5 0.6 0.5 0.6	mA mA mA mA
I_{SD}	Supply Current in Power-Down Mode (Note 6)	$V_{CC} = 5\text{V}$	●	0.5	2	μA

ELECTRICAL CHARACTERISTICS

The ● denotes the specifications which apply over the full operating temperature range, otherwise specifications are at $T_A = 25^\circ\text{C}$. $V_{CC} = 2.7\text{V}$ to 5.5V , V_{OUT} unloaded unless otherwise specified.

LTC2632-LI12/-LI10/-LI8/-LX12/-LX10/-LX8/-LZ12/-LZ10/-LZ8, LTC2632A-LI12/-LX12/-LZ12 ($V_{FS} = 2.5\text{V}$)

SYMBOL	PARAMETER	CONDITIONS	MIN	TYP	MAX	UNITS	
Reference Input							
	Input Voltage Range		●	1	V_{CC}	V	
	Resistance		●	120	160	200	$k\Omega$
	Capacitance			12		pF	
I_{REF}	Reference Current, Power-Down Mode	DAC Powered Down	●	0.005	5.0	μA	
Reference Output							
	Output Voltage		●	1.24	1.25	1.26	V
	Reference Temperature Coefficient			± 10		ppm/ $^\circ\text{C}$	
	Output Impedance			0.5		$k\Omega$	
	Capacitive Load Driving			10		μF	
	Short-Circuit Current	$V_{CC} = 5.5\text{V}$, REF Shorted to GND		2.5		mA	
Digital I/O							
V_{IH}	Digital Input High Voltage	$V_{CC} = 3.6\text{V}$ to 5.5V $V_{CC} = 2.7\text{V}$ to 3.6V	● ●	2.4 2.0		V V	
V_{IL}	Digital Input Low Voltage	$V_{CC} = 4.5\text{V}$ to 5.5V $V_{CC} = 2.7\text{V}$ to 4.5V	● ●		0.8 0.6	V V	
I_{LK}	Digital Input Leakage	$V_{IN} = \text{GND}$ to V_{CC}	●		± 1	μA	
C_{IN}	Digital Input Capacitance	(Note 7)	●		8	pF	
AC Performance							
t_S	Settling Time	$V_{CC} = 3\text{V}$ (Note 8) $\pm 0.39\%$ ($\pm 1\text{LSB}$ at 8 Bits) $\pm 0.098\%$ ($\pm 1\text{LSB}$ at 10 Bits) $\pm 0.024\%$ ($\pm 1\text{LSB}$ at 12 Bits)			3.5 3.9 4.4	μs μs μs	
	Voltage Output Slew Rate			1.0		V/ μs	
	Capacitive Load Driving			500		pF	
	Glitch Impulse	At Mid-Scale Transition		2.8		nV \cdot s	
	DAC-to-DAC Crosstalk	1 DAC Held at FS, 1 DAC Switch 0 to FS		4.5		nV \cdot s	
	Multiplying Bandwidth	External Reference		320		kHz	
e_n	Output Voltage Noise Density	At $f = 1\text{kHz}$, External Reference At $f = 10\text{kHz}$, External Reference At $f = 1\text{kHz}$, Internal Reference At $f = 10\text{kHz}$, Internal Reference		180 160 200 180		nV/ $\sqrt{\text{Hz}}$ nV/ $\sqrt{\text{Hz}}$ nV/ $\sqrt{\text{Hz}}$ nV/ $\sqrt{\text{Hz}}$	
	Output Voltage Noise	0.1Hz to 10Hz, External Reference 0.1Hz to 10Hz, Internal Reference 0.1Hz to 200kHz, External Reference 0.1Hz to 200kHz, Internal Reference $C_{REF} = 0.1\mu\text{F}$		30 35 680 730		μV_{P-P} μV_{P-P} μV_{P-P} μV_{P-P}	

TIMING CHARACTERISTICS The ● denotes the specifications which apply over the full operating temperature range, otherwise specifications are at $T_A = 25^\circ\text{C}$. $V_{CC} = 2.7\text{V}$ to 5.5V , V_{OUT} unloaded unless otherwise specified.

LTC2632-LI12/-LI10/-LI8/-LX12/-LX10/-LX8/-LZ12/-LZ10/-LZ8, LTC2632A-LI12/-LX12/-LZ12 ($V_{FS} = 2.5\text{V}$)

SYMBOL	PARAMETER	CONDITIONS	MIN	TYP	MAX	UNITS
t_1	SDI Valid to SCK Setup	(Figure 1) ●	4			ns
t_2	SDI Valid to SCK Hold	(Figure 1) ●	4			ns
t_3	SCK High Time	(Figure 1) ●	9			ns
t_4	SCK Low Time	(Figure 1) ●	9			ns
t_5	$\overline{\text{CS}}/\text{LD}$ Pulse Width	(Figure 1) ●	10			ns
t_6	LSB SCK High to $\overline{\text{CS}}/\text{LD}$ High	(Figure 1) ●	7			ns
t_7	$\overline{\text{CS}}/\text{LD}$ Low to SCK High	(Figure 1) ●	7			ns
t_{10}	$\overline{\text{CS}}/\text{LD}$ High to SCK Positive Edge	(Figure 1) ●	7			ns
	SCK Frequency	50% Duty Cycle ●			50	MHz

ELECTRICAL CHARACTERISTICS

The ● denotes the specifications which apply over the full operating temperature range, otherwise specifications are at $T_A = 25^\circ\text{C}$. $V_{CC} = 4.5\text{V}$ to 5.5V , V_{OUT} unloaded unless otherwise specified.

LTC2632-HI12/-HI10/-HI8/-HZ12/-HZ10/-HZ8, LTC2632A-HI12/-HZ12 ($V_{FS} = 4.096\text{V}$)

SYMBOL	PARAMETER	CONDITIONS	LTC2632-8			LTC2632-10			LTC2632-12			LTC2632A-12			UNITS
			MIN	TYP	MAX	MIN	TYP	MAX	MIN	TYP	MAX	MIN	TYP	MAX	
DC Performance															
	Resolution		●	8		10		12		12				Bits	
	Monotonicity	$V_{CC} = 5\text{V}$, Internal Ref. (Note 3)	●	8		10		12		12				Bits	
DNL	Differential Nonlinearity	$V_{CC} = 5\text{V}$, Internal Ref. (Note 3)	●		± 0.5		± 0.5		± 1		± 1			LSB	
INL	Integral Nonlinearity	$V_{CC} = 5\text{V}$, Internal Ref. (Note 3)	●	± 0.05	± 0.5	± 0.2	± 1	± 1	± 2.5	± 0.5	± 1.5			LSB	
ZSE	Zero-Scale Error	$V_{CC} = 5\text{V}$, Internal Ref., Code = 0	●	0.5	5	0.5	5	0.5	5	0.5	5			mV	
V_{OS}	Offset Error	$V_{CC} = 5\text{V}$, Internal Ref. (Note 4)	●	± 0.5	± 5	± 0.5	± 5	± 0.5	± 5	± 0.5	± 5			mV	
V_{OSTC}	V_{OS} Temperature Coefficient	$V_{CC} = 5\text{V}$, Internal Ref.		± 10		± 10		± 10		± 10				$\mu\text{V}/^\circ\text{C}$	
GE	Gain Error	$V_{CC} = 5\text{V}$, Internal Ref.	●	0.2	0.8	0.2	0.8	0.2	0.8	0.2	0.8			%FSR	
GE_{TC}	Gain Temperature Coefficient	$V_{CC} = 5\text{V}$, Internal Ref. (Note 9) C-Grade H-Grade		10 10		10 10		10 10		10 10				ppm/ $^\circ\text{C}$ ppm/ $^\circ\text{C}$	
	Load Regulation	$V_{CC} = 5\text{V} \pm 10\%$, Internal Ref. Mid-Scale, $-10\text{mA} \leq I_{OUT} \leq 10\text{mA}$	●	0.006	0.01	0.022	0.04	0.09	0.16	0.09	0.16			LSB/ mA	
R_{OUT}	DC Output Impedance	$V_{CC} = 5\text{V} \pm 10\%$, Internal Ref. Mid-Scale, $-10\text{mA} \leq I_{OUT} \leq 10\text{mA}$	●	0.09	0.156	0.09	0.156	0.09	0.156	0.09	0.156			Ω	

SYMBOL	PARAMETER	CONDITIONS	MIN	TYP	MAX	UNITS
V_{OUT}	DAC Output Span	External Reference Internal Reference		0 to V_{REF} 0 to 4.096		V V
PSR	Power Supply Rejection	$V_{CC} = 5\text{V} \pm 10\%$		-80		dB
I_{SC}	Short-Circuit Output Current (Note 5) Sinking Sourcing	$V_{FS} = V_{CC} = 5.5\text{V}$ Zero-Scale; V_{OUT} Shorted to V_{CC} Full-Scale; V_{OUT} Shorted to GND		27 -28	48 -48	mA mA

Power Supply

V_{CC}	Positive Supply Voltage	For Specified Performance	●	4.5	5.5	V
I_{CC}	Supply Current (Note 6)	$V_{CC} = 5\text{V}$, $V_{REF} = 4.096\text{V}$, External Reference $V_{CC} = 5\text{V}$, Internal Reference	● ●	0.4 0.5	0.6 0.7	mA mA
I_{SD}	Supply Current in Power-Down Mode (Note 6)	$V_{CC} = 5\text{V}$	●	0.5	2	μA

ELECTRICAL CHARACTERISTICS

The ● denotes the specifications which apply over the full operating temperature range, otherwise specifications are at $T_A = 25^\circ\text{C}$. $V_{CC} = 4.5\text{V}$ to 5.5V , V_{OUT} unloaded unless otherwise specified.

LTC2632-HI12/-HI10/-HI8/-HZ12/-HZ10/-HZ8, LTC2632A-HI12/-HZ12 ($V_{FS} = 4.096\text{V}$)

SYMBOL	PARAMETER	CONDITIONS	MIN	TYP	MAX	UNITS	
Reference Input							
	Input Voltage Range		●	1	V_{CC}	V	
	Resistance		●	120	160	200	$k\Omega$
	Capacitance			12		pF	
I_{REF}	Reference Current, Power-Down Mode	DAC Powered Down	●	0.005	5.0	μA	
Reference Output							
	Output Voltage		●	2.032	2.048	2.064	V
	Reference Temperature Coefficient			± 10		ppm/ $^\circ\text{C}$	
	Output Impedance			0.5		$k\Omega$	
	Capacitive Load Driving			10		μF	
	Short-Circuit Current	$V_{CC} = 5.5\text{V}$; REF Shorted to GND		4		mA	
Digital I/O							
V_{IH}	Digital Input High Voltage		●	2.4		V	
V_{IL}	Digital Input Low Voltage		●		0.8	V	
I_{LK}	Digital Input Leakage	$V_{IN} = \text{GND to } V_{CC}$	●		± 1	μA	
C_{IN}	Digital Input Capacitance	(Note 7)	●		8	pF	
AC Performance							
t_S	Settling Time	$V_{CC} = 5\text{V}$ (Note 8) $\pm 0.39\%$ ($\pm 1\text{LSB}$ at 8 Bits) $\pm 0.098\%$ ($\pm 1\text{LSB}$ at 10 Bits) $\pm 0.024\%$ ($\pm 1\text{LSB}$ at 12 Bits)			3.9 4.1 4.9	μs μs μs	
	Voltage Output Slew Rate			1.0		V/ μs	
	Capacitive Load Driving			500		pF	
	Glitch Impulse	At Mid-Scale Transition		3.0		nV•s	
	DAC-to-DAC Crosstalk	1 DAC Held at FS, 1 DAC Switch 0 to FS		6.7		nV•s	
	Multiplying Bandwidth	External Reference		320		kHz	
e_n	Output Voltage Noise Density	At $f = 1\text{kHz}$, External Reference At $f = 10\text{kHz}$, External Reference At $f = 1\text{kHz}$, Internal Reference At $f = 10\text{kHz}$, Internal Reference			180 160 250 230	nV/ $\sqrt{\text{Hz}}$ nV/ $\sqrt{\text{Hz}}$ nV/ $\sqrt{\text{Hz}}$ nV/ $\sqrt{\text{Hz}}$	
	Output Voltage Noise	0.1Hz to 10Hz, External Reference 0.1Hz to 10Hz, Internal Reference 0.1Hz to 200kHz, External Reference 0.1Hz to 200kHz, Internal Reference $C_{REF} = 0.1\mu\text{F}$			30 40 680 750	μV_{p-p} μV_{p-p} μV_{p-p} μV_{p-p}	

TIMING CHARACTERISTICS The ● denotes the specifications which apply over the full operating temperature range, otherwise specifications are at $T_A = 25^\circ\text{C}$. $V_{CC} = 4.5\text{V}$ to 5.5V , V_{OUT} unloaded unless otherwise specified.

LTC2632-HI12/-HI10/-HI8/-HZ12/-HZ10/-HZ8, LTC2632A-HI12/-HZ12 ($V_{FS} = 4.096\text{V}$)

SYMBOL	PARAMETER	CONDITIONS	MIN	TYP	MAX	UNITS
t_1	SDI Valid to SCK Setup	(Figure 1)	●	4		ns
t_2	SDI Valid to SCK Hold	(Figure 1)	●	4		ns
t_3	SCK High Time	(Figure 1)	●	9		ns
t_4	SCK Low Time	(Figure 1)	●	9		ns
t_5	$\overline{\text{CS}}/\text{LD}$ Pulse Width	(Figure 1)	●	10		ns
t_6	LSB SCK High to $\overline{\text{CS}}/\text{LD}$ High	(Figure 1)	●	7		ns
t_7	$\overline{\text{CS}}/\text{LD}$ Low to SCK High	(Figure 1)	●	7		ns
t_{10}	$\overline{\text{CS}}/\text{LD}$ High to SCK Positive Edge	(Figure 1)	●	7		ns
	SCK Frequency	50% Duty Cycle	●		50	MHz

Note 1: Stresses beyond those listed under Absolute Maximum Ratings may cause permanent damage to the device. Exposure to any Absolute Maximum Rating condition for extended periods may affect device reliability and lifetime.

Note 2: All voltages are with respect to GND

Note 3: Linearity and monotonicity are defined from code k_L to code $2^N - 1$, where N is the resolution and k_L is given by $k_L = 0.016 \cdot (2^N / V_{FS})$, rounded to the nearest whole code. For $V_{FS} = 2.5\text{V}$ and $N = 12$, $k_L = 26$ and linearity is defined from code 26 to code 4,095. For $V_{FS} = 4.096\text{V}$ and $N = 12$, $k_L = 16$ and linearity is defined from code 16 to code 4,095.

Note 4: Inferred from measurement at code 16 (LTC2632-12), code 4 (LTC2632-10) or code 1 (LTC2632-8), and at full-scale.

Note 5: This IC includes current limiting that is intended to protect the device during momentary overload conditions. Junction temperature can exceed the rated maximum during current limiting. Continuous operation

above the specified maximum operating junction temperature may impair device reliability.

Note 6: Digital inputs at 0V or V_{CC} .

Note 7: Guaranteed by design and not production tested.

Note 8: Internal Reference mode. DAC is stepped 1/4 scale to 3/4 scale and 3/4 scale to 1/4 scale. Load is $2\text{k}\Omega$ in parallel with 100pF to GND.

Note 9: Temperature coefficient is calculated by dividing the maximum change in output voltage by the specified temperature range.

Note 10: $\overline{\text{CS}}/\text{LD}$ can be held at high voltage as V_{CC} ramps upon power-up.

TYPICAL PERFORMANCE CHARACTERISTICS

$T_A = 25^\circ\text{C}$, unless otherwise noted. LTC2632-L12 (Internal Reference, $V_{FS} = 2.5\text{V}$)

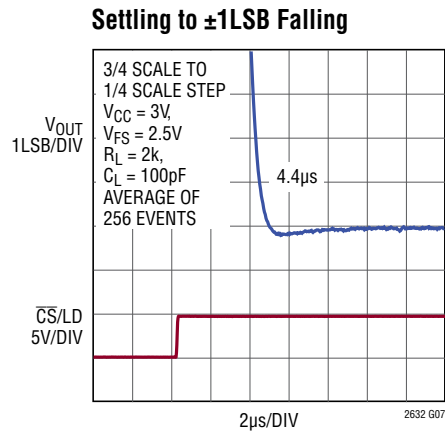
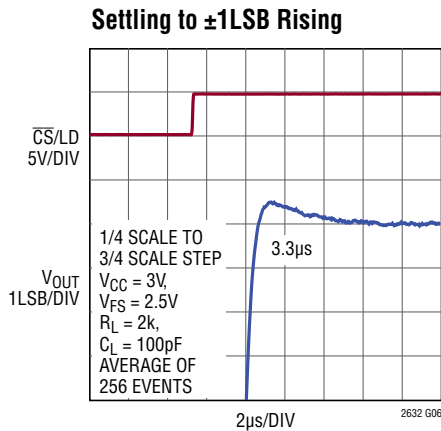
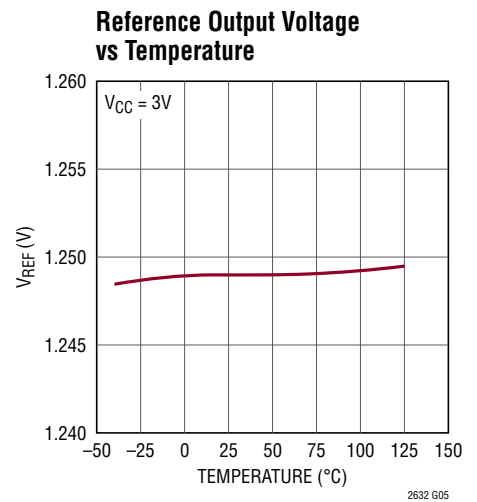
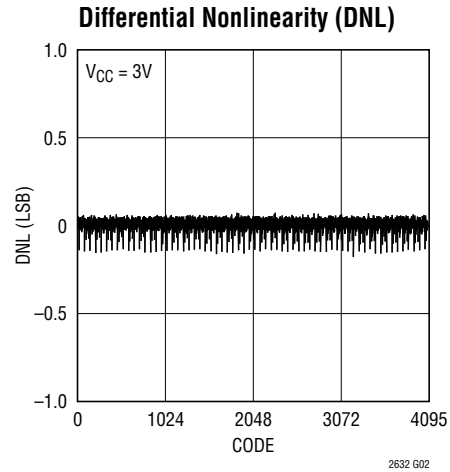
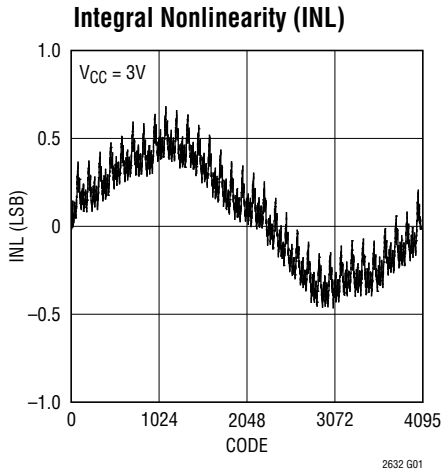

TYPICAL PERFORMANCE CHARACTERISTICS

$T_A = 25^\circ\text{C}$, unless otherwise noted. LTC2632-H12 (Internal Reference, $V_{FS} = 4.096\text{V}$)

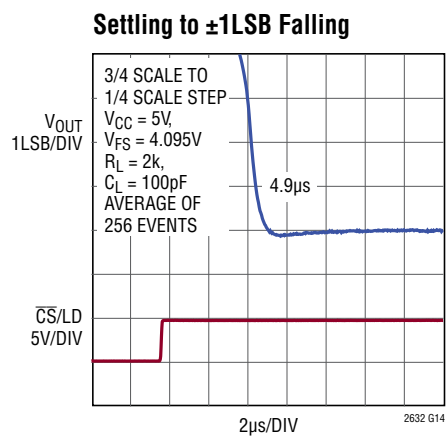
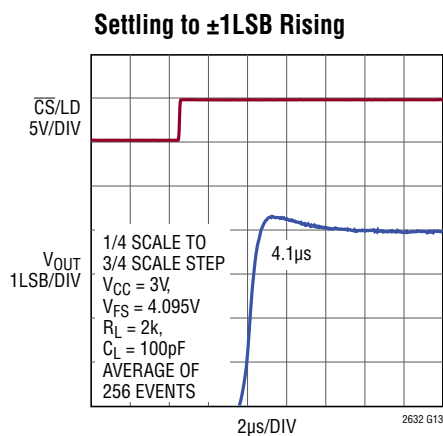
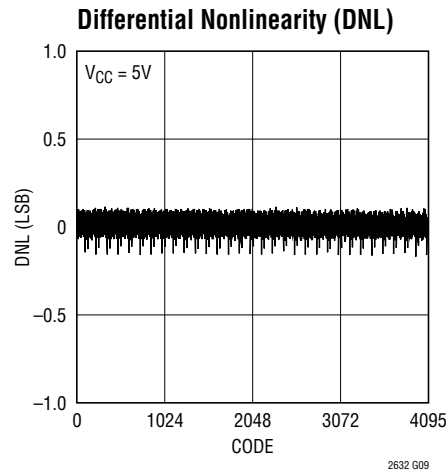
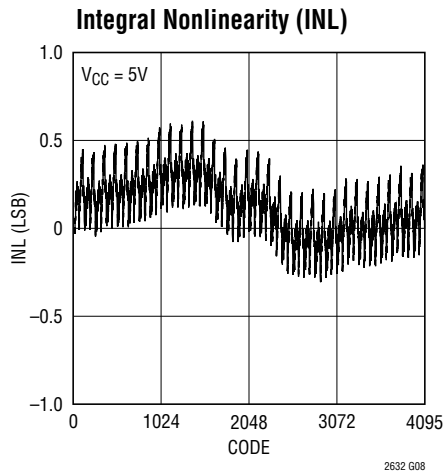

TYPICAL PERFORMANCE CHARACTERISTICS $T_A = 25^\circ\text{C}$, unless otherwise noted.

LTC2632-10

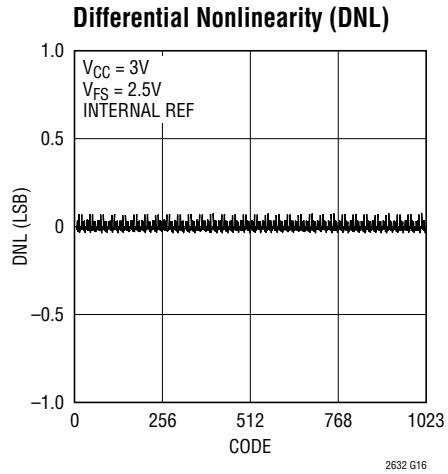
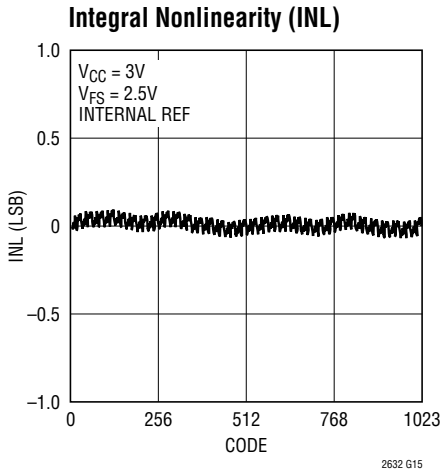

LTC2632-8

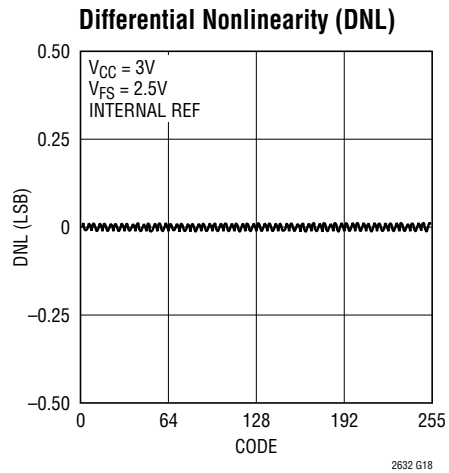
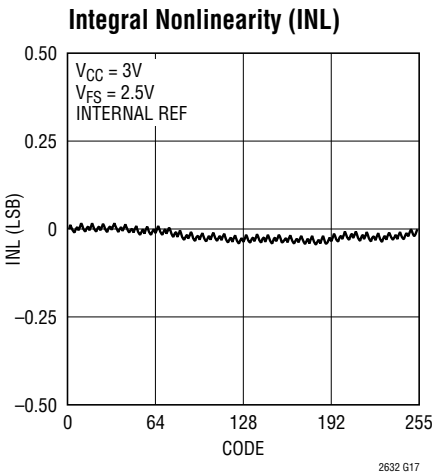

LTC2632

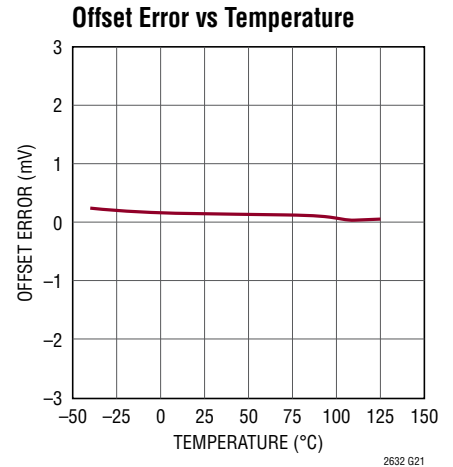
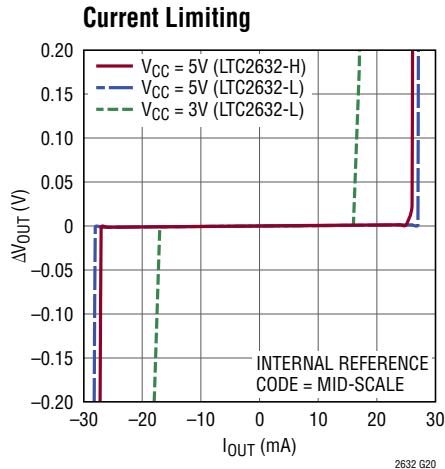

TYPICAL PERFORMANCE CHARACTERISTICS $T_A = 25^\circ\text{C}$, unless otherwise noted.

LTC2632

Large-Signal Response



Mid-Scale Glitch Impulse

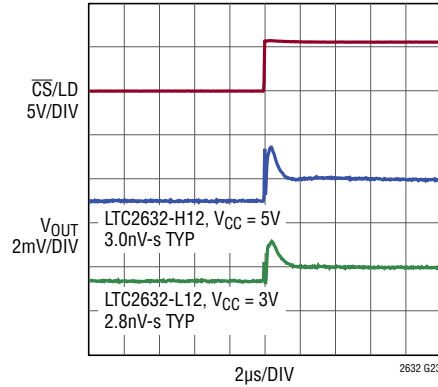

Power-On Reset Glitch

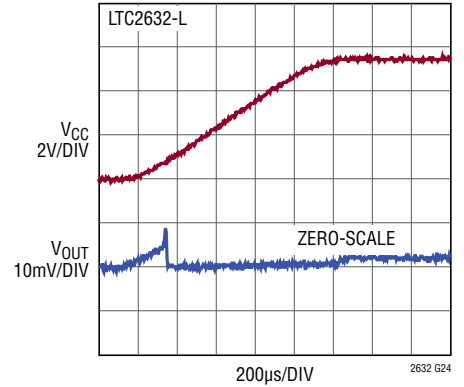

Headroom at Rails vs Output Current

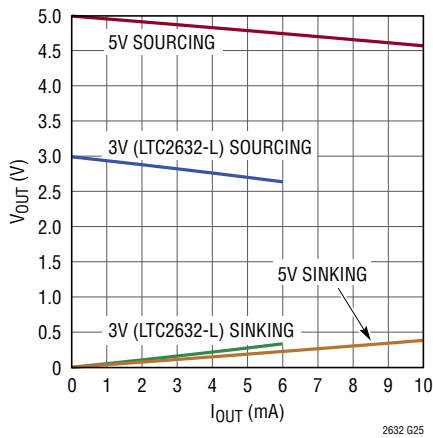

Exiting Power-Down to Mid-Scale



Power-On Reset to Mid-Scale

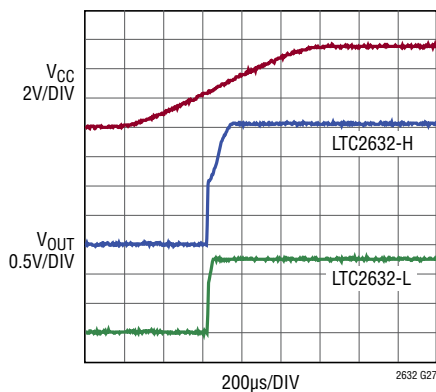

Supply Current vs Logic Voltage



TYPICAL PERFORMANCE CHARACTERISTICS $T_A = 25^\circ\text{C}$, unless otherwise noted.

LTC2632

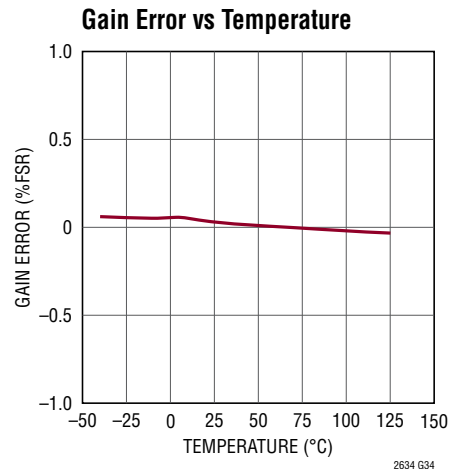
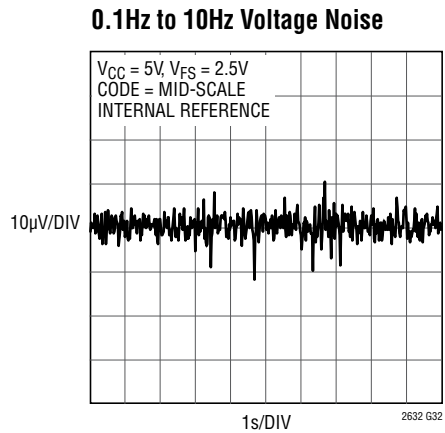
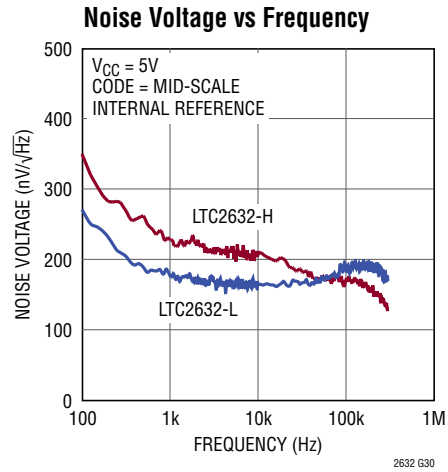
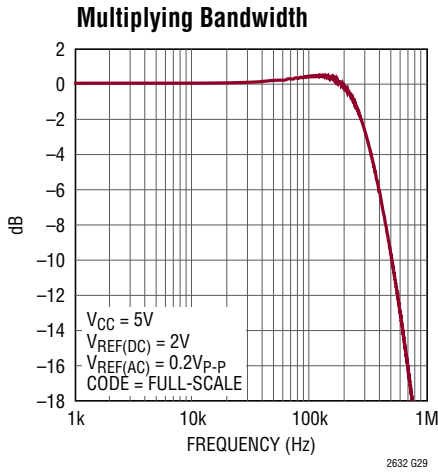

PIN FUNCTIONS

SCK (Pin 1): Serial Interface Clock Input. CMOS and TTL compatible.

$\overline{\text{CS/LD}}$ (Pin 2): Serial Interface Chip Select/Load Input. When $\overline{\text{CS/LD}}$ is low, SCK is enabled for shifting data on SDI into the register. When $\overline{\text{CS/LD}}$ is taken high, SCK is disabled and the specified command (see Table 1) is executed.

REF (Pin 3): Reference Voltage Input or Output. When external reference mode is selected, REF is an input ($1\text{V} \leq V_{\text{REF}} \leq V_{\text{CC}}$) where the voltage supplied sets the full-scale DAC output voltage. When internal reference is selected, the 10ppm/°C 1.25V (LTC2632-L) or 2.048V (LTC2632-H) internal reference (half full-scale) is available at the pin. This output may be bypassed to GND with up to 10 μF (0.1 μF is recommended) and must be buffered when driving external DC load current.

GND (Pin 4): Ground.

$V_{\text{OUT A}}$, $V_{\text{OUT B}}$ (Pins 5, 6): DAC Analog Voltage Output.

V_{CC} (Pin 7): Supply Voltage Input. $2.7\text{V} \leq V_{\text{CC}} \leq 5.5\text{V}$ (LTC2632-L) or $4.5\text{V} \leq V_{\text{CC}} \leq 5.5\text{V}$ (LTC2632-H). Bypass to GND with a 0.1 μF capacitor.

SDI (Pin 8): Serial Interface Data Input. Data on SDI is clocked into the DAC on the rising edge of SCK. The LTC2632 accepts input word lengths of either 24 or 32 bits.

BLOCK DIAGRAM

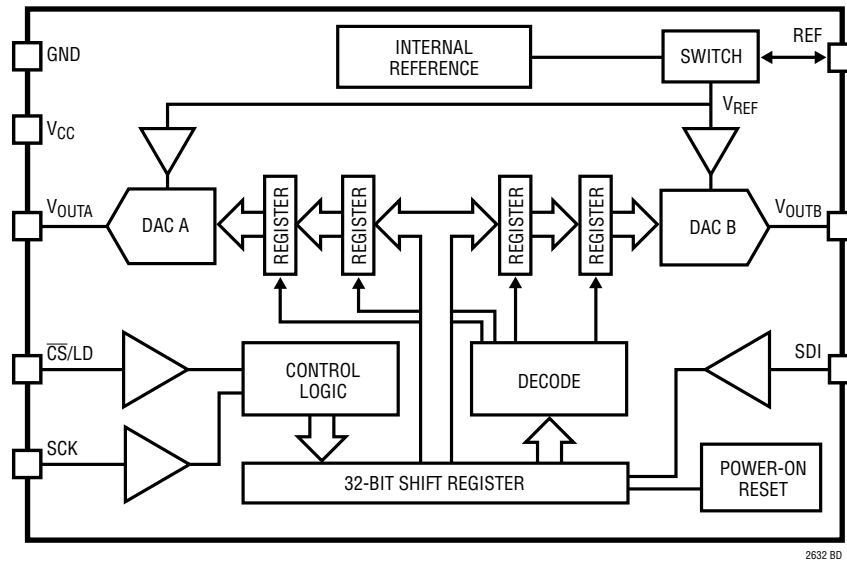

2632 BD

TIMING DIAGRAM

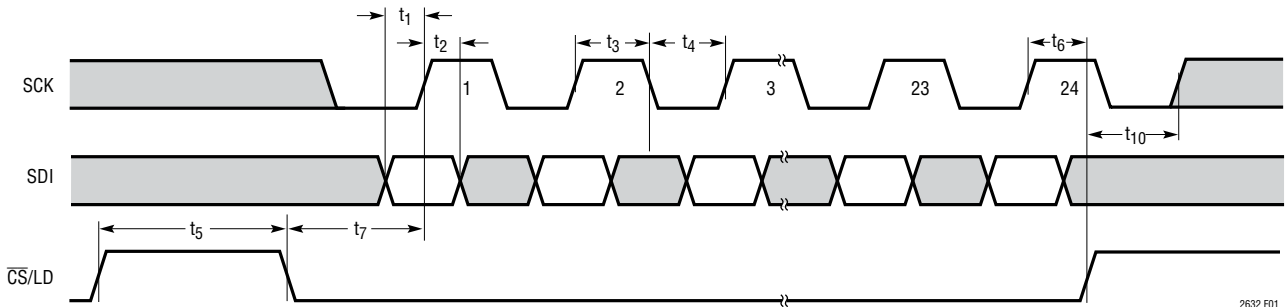

2632 F01

Figure 1. Serial Interface Timing

OPERATION

The LTC2632 is a family of dual voltage output DACs in an 8-lead TSOT package. Each DAC can operate rail-to-rail using an external reference, or with its full-scale voltage set by an integrated reference. Fifteen combinations of accuracy (12-, 10-, and 8-bit), power-on reset value (zero-scale, mid-scale in internal reference mode, or mid-scale in external reference mode), and full-scale voltage (2.5V or 4.096V) are available. The LTC2632 is controlled using a 3-wire SPI/MICROWIRE compatible interface.

Power-On Reset

The LTC2632-HZ/LTC2632-LZ clear the output to zero-scale when power is first applied, making system initialization consistent and repeatable.

For some applications, downstream circuits are active during DAC power-up, and may be sensitive to nonzero outputs from the DAC during this time. The LTC2632 contains circuitry to reduce the power-on glitch: the analog output typically rises less than 10mV above zero-scale during power-on if the power supply is ramped to 5V in 1ms or more. In general, the glitch amplitude decreases as the power supply ramp time is increased. See “Power-On Reset Glitch” in the Typical Performance Characteristics section.

The LTC2632-HI/LTC2632-LI/LTC2632-LX provides an alternative reset, setting the output to mid-scale when power is first applied. The LTC2632-LI and LTC2632-HI power-up in internal reference mode, with the output set to a mid-scale voltage of 1.25V and 2.048V respectively. The LTC2632-LX powers up in external reference mode, with the output set to mid-scale of the external reference. Default reference mode selection is described in the Reference Modes section.

Power Supply Sequencing

The voltage at REF (Pin 3) must be kept within the range $-0.3V \leq V_{REF} \leq V_{CC} + 0.3V$ (see the Absolute Maximum Ratings section). Particular care should be taken to observe these limits during power supply turn-on and turn-off sequences, when the voltage at V_{CC} is in transition.

Transfer Function

The digital-to-analog transfer function is

$$V_{OUT(IDEAL)} = \left(\frac{k}{2^N} \right) \cdot V_{REF}$$

where k is the decimal equivalent of the binary DAC input code, N is the resolution, and V_{REF} is either 2.5V (LTC2632-LI/LTC2632-LX/LTC2632-LZ) or 4.096V (LTC2632-HI/LTC2632-HZ) when in internal reference mode, and the voltage at REF when in external reference mode.

Table 1. Command Codes

COMMAND*				
C3	C2	C1	C0	
0	0	0	0	Write to Input Register n
0	0	0	1	Update (Power-Up) DAC Register n
0	0	1	0	Write to Input Register n , Update (Power-Up) All
0	0	1	1	Write to and Update (Power-Up) DAC Register n
0	1	0	0	Power-Down n
0	1	0	1	Power-Down Chip (All DAC's and Reference)
0	1	1	0	Select Internal Reference (Power-Up Reference)
0	1	1	1	Select External Reference (Power-Down Internal Reference)
1	1	1	1	No Operation

*Command codes not shown are reserved and should not be used.

Table 2. Address Codes

ADDRESS (n)*				
A3	A2	A1	A0	
0	0	0	0	DAC A
0	0	0	1	DAC B
1	1	1	1	All DACs

* Address codes not shown are reserved and should not be used.

OPERATION

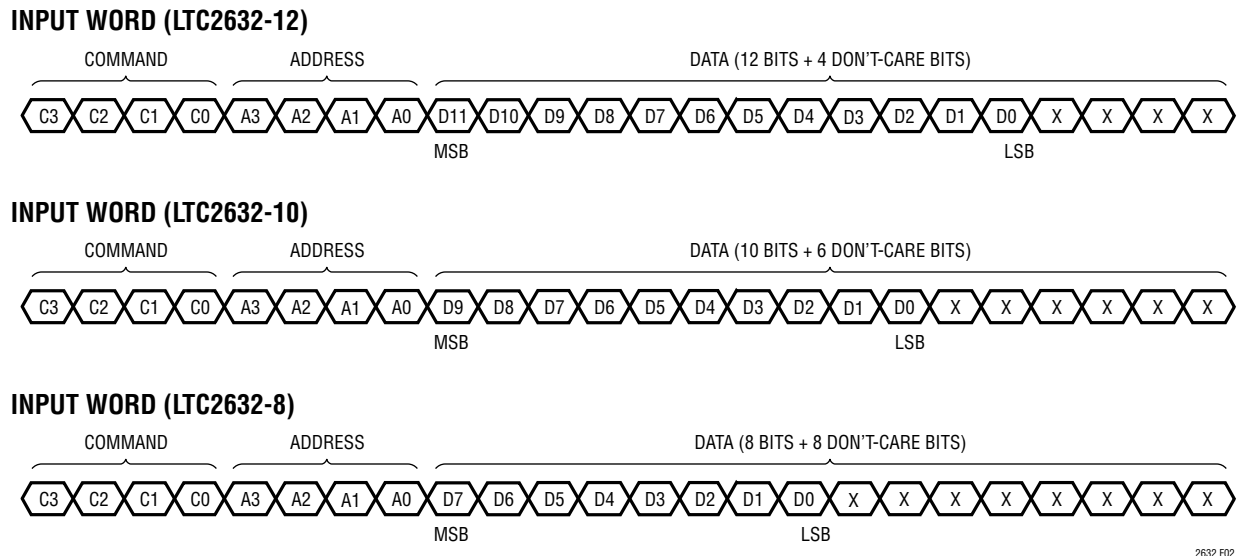

Figure 2. Command and Data Input Format

Serial Interface

The $\overline{\text{CS}}/\text{LD}$ input is level triggered. When this input is taken low, it acts as a chip-select signal, enabling the SDI and SCK buffers and the input shift register. Data (SDI input) is transferred at the next 24 rising SCK edges. The 4-bit command, C3-C0, is loaded first; then the 4-bit DAC address, A3-A0; and finally the 16-bit data word. The data word comprises the 12-, 10- or 8-bit input code, ordered MSB-to-LSB, followed by 4, 6 or 8 don't-care bits (LTC2632-12, LTC2632-10 and LTC2632-8 respectively; see Figure 2). Data can only be transferred to the device when the $\overline{\text{CS}}/\text{LD}$ signal is low, beginning on the first rising edge of SCK. SCK may be high or low at the falling edge of $\overline{\text{CS}}/\text{LD}$. The rising edge of $\overline{\text{CS}}/\text{LD}$ ends the data transfer and causes the device to execute the command specified in the 24-bit input sequence. The complete sequence is shown in Figure 3a.

The command (C3-C0) and address (A3-A0) assignments are shown in Tables 1 and 2. The first four commands in Table 1 consist of write and update operation. A Write

operation loads a 16-bit data word from the 24-bit shift register into the input register of the selected DAC, n . An Update operation copies the data word from the input register to the DAC register. Once copied into the DAC register, the data word becomes the active 12-, 10-, or 8-bit input code, and is converted to an analog voltage at the DAC output. Write to and Update combines the first two commands. The Update operation also powers up the DAC if it had been in power-down mode. The data path and registers are shown in the Block Diagram.

While the minimum input sequence is 24 bits, it may optionally be extended to 32 bits to accommodate microprocessors that have a minimum word width of 16 bits (2 bytes). To use the 32-bit width, 8 don't-care bits are transferred to the device first, followed by the 24-bit sequence described. Figure 3b shows the 32-bit sequence.

The 16-bit data word is ignored for all commands that do not include a Write operation.

OPERATION

Reference Modes

For applications where an accurate external reference is not available, nor desirable due to limited space, the LTC2632 has a user-selectable, integrated reference. The integrated reference voltage is internally amplified by 2x to provide the full-scale DAC output voltage range. The LTC2632-LI/LTC2632-LX/LTC2632-LZ provides a full-scale output of 2.5V. The LTC2632-HI/LTC2632-HZ provides a full-scale output of 4.096V. The internal reference can be useful in applications where the supply voltage is poorly regulated. Internal reference mode can be selected by using command 0110b, and is the power-on default for LTC2632-HZ/LTC2632-LZ, as well as for LTC2632-HI/LTC2632-LI.

The 10ppm/°C, 1.25V (LTC2632-LI/LTC2632-LX/LTC2632-LZ) or 2.048V (LTC2632-HI/LTC2632-HZ) internal reference is available at the REF pin. Adding bypass capacitance to the REF pin will improve noise performance; 0.1μF is recommended, and up to 10μF can be driven without oscillation. This output must be buffered when driving an external DC load current.

Alternatively, the DAC can operate in external reference mode using command 0111b. In this mode, an input voltage supplied externally to the REF pin provides the reference ($1V \leq V_{REF} \leq V_{CC}$) and the supply current is reduced. The external reference voltage supplied sets the full-scale DAC output voltage. External reference mode is the power-on default for the LTC2632-LX.

The reference mode of LTC2632-HZ/LTC2632-LZ/LTC2632-HI/LTC2632-LI (internal reference power-on default), can be changed by software command after power-up. The same is true for the LTC2632-LX (external reference power-on default).

Power-Down Mode

For power-constrained applications, power-down mode can be used to reduce the supply current whenever less than two DAC outputs are needed. When in power-down, the buffer amplifiers, bias circuits, and integrated reference circuits are disabled, and draw essentially zero current. The DAC outputs are put into a high-impedance state, and the output pins are passively pulled to ground through individual 200k resistors. Input and DAC-register contents are not disturbed during power-down.

Either channel or both channels can be put into power-down mode by using command 0100b in combination with the appropriate DAC address (*n*). The supply current is reduced approximately 30% for each DAC powered down. The integrated reference is automatically powered down when external reference is selected using command 0111b. In addition, all the DAC channels and the integrated reference together can be put into power-down mode using power-down chip command 0101b. When the integrated reference is in power-down mode, the REF pin becomes high impedance (typically > 1GΩ). For all power-down commands the 16-bit data word is ignored.

Normal operation resumes after executing any command that includes a DAC update (as shown in Table 1). The selected DAC is powered up as its voltage output is updated. When a DAC which is in a powered-down state is powered up and updated, normal settling is delayed. If less than two DACs are in a powered-down state prior to the update command, the power-up delay time is 10μs. However, if both DACs and the integrated reference are powered down, then the main bias generation circuit block has been automatically shut down in addition to the DAC amplifiers and reference buffers. In this case, the power up delay time is 12μs. The power-up of the integrated reference depends on the command that powered it down. If the reference is powered down using the select external reference command (0111b), then it can only be powered back up using select internal reference command (0110b). However, if the reference was powered down using power-down chip command (0101b), then in addition to the select internal reference command (0110b), any command that powers up the DACs will also power-up the integrated reference.

OPERATION

Voltage Output

The LTC2632's integrated rail-to-rail amplifier has guaranteed load regulation when sourcing or sinking up to 10mA at 5V, and 5mA at 3V.

Load regulation is a measure of the amplifier's ability to maintain the rated voltage accuracy over a wide range of load current. The measured change in output voltage per change in forced load current is expressed in LSB/mA.

DC output impedance is equivalent to load regulation, and may be derived from it by simply calculating a change in units from LSB/mA to ohms. The amplifier's DC output impedance is 0.1Ω when driving a load well away from the rails.

When drawing a load current from either rail, the output voltage headroom with respect to that rail is limited by the 50Ω typical channel resistance of the output devices (e.g., when sinking 1mA, the minimum output voltage is $50\Omega \cdot 1\text{mA}$, or 50mV). See the graph *Headroom at Rails vs Output Current* in the Typical Performance Characteristics section.

The amplifier is stable driving capacitive loads of up to 500pF.

Rail-to-Rail Output Considerations

In any rail-to-rail voltage output device, the output is limited to voltages within the supply range.

Since the analog output of the DAC cannot go below ground, it may limit for the lowest codes as shown in Figure 4b. Similarly, limiting can occur near full-scale when the REF pin is tied to V_{CC} . If $V_{REF} = V_{CC}$ and the DAC full-scale error (FSE) is positive, the output for the highest codes limits at V_{CC} , as shown in Figure 4c. No full-scale limiting can occur if V_{REF} is less than $V_{CC} - \text{FSE}$.

Offset and linearity are defined and tested over the region of the DAC transfer function where no output limiting can occur.

Board Layout

The PC board should have separate areas for the analog and digital sections of the circuit. A single, solid ground plane should be used, with analog and digital signals carefully routed over separate areas of the plane. This keeps digital signals away from sensitive analog signals and minimizes the interaction between digital ground currents and the analog section of the ground plane. The resistance from the LTC2632 GND pin to the ground plane should be as low as possible. Resistance here will add directly to the effective DC output impedance of the device (typically 0.1Ω). Note that the LTC2632 is no more susceptible to this effect than any other parts of this type; on the contrary, it allows layout-based performance improvements to shine rather than limiting attainable performance with excessive internal resistance.

Another technique for minimizing errors is to use a separate power ground return trace on another board layer. The trace should run between the point where the power supply is connected to the board and the DAC ground pin. Thus the DAC ground pin becomes the common point for analog ground, digital ground, and power ground. When the LTC2632 is sinking large currents, this current flows out the ground pin and directly to the power ground trace without affecting the analog ground plane voltage.

It is sometimes necessary to interrupt the ground plane to confine digital ground currents to the digital portion of the plane. When doing this, make the gap in the plane only as long as it needs to be to serve its purpose and ensure that no traces cross over the gap.

Bypass capacitors should be placed as close to the pins as possible with a low impedance path to GND.

OPERATION

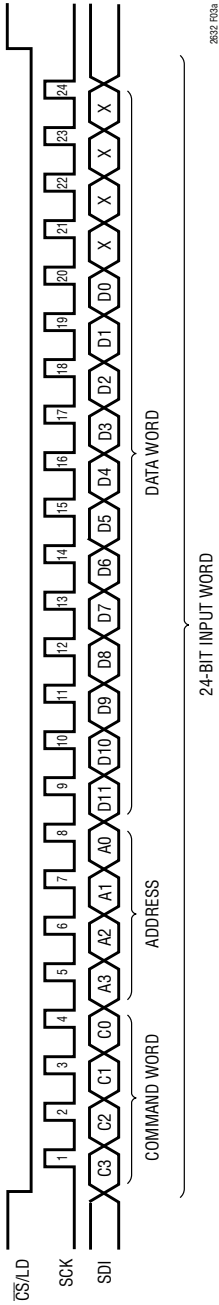

Figure 3a. . LTC2632-12 24-Bit Load Sequence (Minimum Input Word)
 LTC2632-10 SDI Data Word: 10-Bit Input Code + 6 Don't-Care Bits;
 LTC2632-8 SDI Data Word: 8-Bit Input Code + 8 Don't-Care Bits

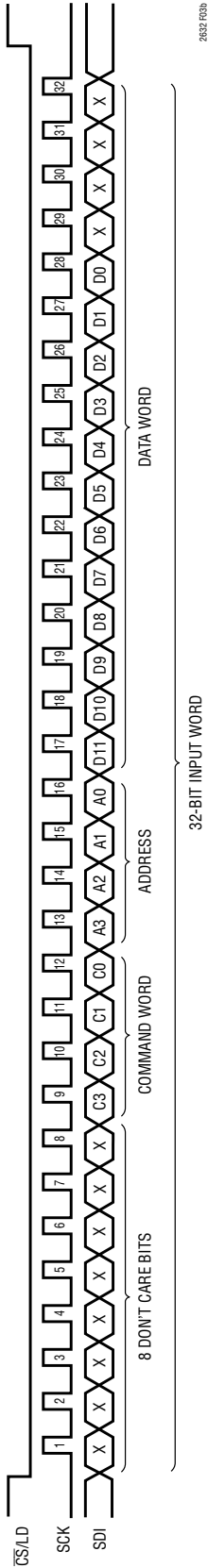

Figure 3b. LTC2632-12 32-Bit Load Sequence
 LTC2632-10 SDI Data Word: 10-Bit Input Code + 6 Don't-Care Bits;
 LTC2632-8 SDI Data Word: 8-Bit Input Code + 8 Don't-Care Bits

OPERATION



Figure 4. Effects of Rail-to-Rail Operation On a DAC Transfer Curve (Shown for 12 Bits)
(a) Overall Transfer Function
(b) Effect of Negative Offset for Codes Near Zero
(c) Effect of Positive Full-Scale Error for Codes Near Full-Scale

PACKAGE DESCRIPTION

TS8 Package
8-Lead Plastic TSOT-23
 (Reference LTC DWG # 05-08-1637 Rev A)

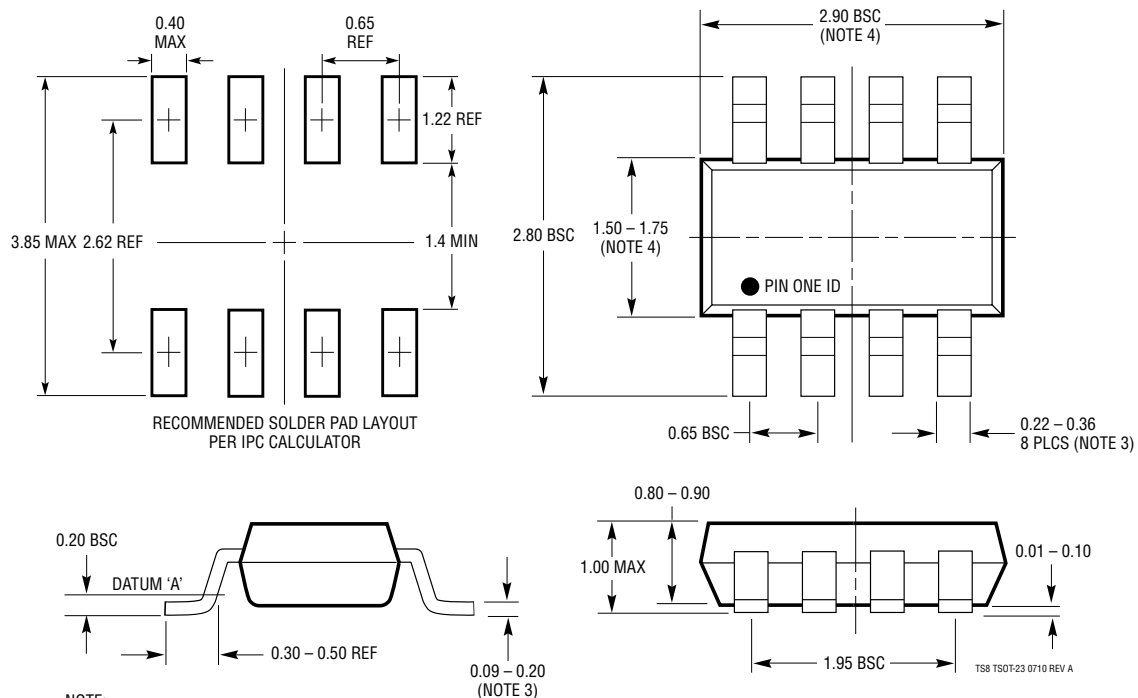

- NOTE:
1. DIMENSIONS ARE IN MILLIMETERS
 2. DRAWING NOT TO SCALE
 3. DIMENSIONS ARE INCLUSIVE OF PLATING
 4. DIMENSIONS ARE EXCLUSIVE OF MOLD FLASH AND METAL BURR
 5. MOLD FLASH SHALL NOT EXCEED 0.254mm
 6. JEDEC PACKAGE REFERENCE IS MO-193

REVISION HISTORY

REV	DATE	DESCRIPTION	PAGE NUMBER
A	03/11	Revised part numbering.	2 to 9, 17, 19, 24
B	06/17	Removed Note 3.	9
C	07/19	Changed A-Grade INL from $\pm 1\text{LSB}$ to $\pm 1.5\text{LSB}$.	1 to 4, 7

TYPICAL APPLICATION

LTC2632 DACs Adjust LTC2755-16 Offset, Amplified with LT1991 PGA to $\pm 5V$



RELATED PARTS

PART NUMBER	DESCRIPTION	COMMENTS
LTC1662	Dual 10-Bit Ultralow Power V_{OUT} DAC in 8-Lead MSOP with External Reference	1.5 μA per DAC, 2.7V to 5.5V Supply Range, Rail-to-Rail Output, SPI Serial Interface
LTC2602/LTC2612/LTC2622	Dual 16-/14-/12-Bit V_{OUT} DACs in 8-Lead MSOP with External Reference	300 μA per DAC, 2.5V to 5.5V Supply Range, Rail-to-Rail Output, SPI Serial Interface
LTC2607/LTC2617/LTC2627	Dual 16-/14-/12-Bit V_{OUT} DACs in 12-Lead DFN with External Reference	260 μA per DAC, 2.7V to 5.5V Supply Range, Rail-to-Rail Output, I ² C Serial Interface
LTC2630	Single 12-/10-/8-Bit V_{OUT} DACs with 10ppm/ $^{\circ}C$ Reference in SC70	180 μA per DAC, 2.7V to 5.5V Supply Range, 10ppm/ $^{\circ}C$ Reference, Rail-to-Rail Output, SPI Serial Interface
LTC2631	Single 12-/10-/8-Bit I ² C V_{OUT} DACs with 10ppm/ $^{\circ}C$ Reference in ThinSOT	180 μA per DAC, 2.7V to 5.5V Supply Range, 10ppm/ $^{\circ}C$ Reference, External REF Mode, Rail-to-Rail Output, I ² C Interface
LTC2634	Quad 12-/10-/8-Bit V_{OUT} DACs with 10ppm/ $^{\circ}C$ Reference	125 μA per DAC, 2.7V to 5.5V Supply Range, 10ppm/ $^{\circ}C$ Reference, External REF Mode, Rail-to-Rail Output, SPI Interface
LTC2636	Octal 12-/10-/8-Bit V_{OUT} DACs with 10ppm/ $^{\circ}C$ Reference	125 μA per DAC, 2.7V to 5.5V Supply Range, 10ppm/ $^{\circ}C$ Reference, External REF Mode, Rail-to-Rail Output, SPI Interface
LTC2640	Single 12-/10-/8-Bit V_{OUT} DACs with 10ppm/ $^{\circ}C$ Reference in ThinSOT	180 μA per DAC, 2.7V to 5.5V Supply Range, 10ppm/ $^{\circ}C$ Reference, External REF Mode, Rail-to-Rail Output, SPI Interface
LTC2654	Quad 16-/12-Bit V_{OUT} DACs with ± 4 LSB INL, ± 1 LSB DNL	4mm \times 4mm QFN-20, SSOP-16 Packages, SPI Interface, Internal 10ppm/ $^{\circ}C$ (Max) Reference



**Стандарт
Электрон
Связь**

Мы молодая и активно развивающаяся компания в области поставок электронных компонентов. Мы поставляем электронные компоненты отечественного и импортного производства напрямую от производителей и с крупнейших складов мира.

Благодаря сотрудничеству с мировыми поставщиками мы осуществляем комплексные и плановые поставки широчайшего спектра электронных компонентов.

Собственная эффективная логистика и склад в обеспечивает надежную поставку продукции в точно указанные сроки по всей России.

Мы осуществляем техническую поддержку нашим клиентам и предпродажную проверку качества продукции. На все поставляемые продукты мы предоставляем гарантию .

Осуществляем поставки продукции под контролем ВП МО РФ на предприятия военно-промышленного комплекса России , а также работаем в рамках 275 ФЗ с открытием отдельных счетов в уполномоченном банке. Система менеджмента качества компании соответствует требованиям ГОСТ ISO 9001.

Минимальные сроки поставки, гибкие цены, неограниченный ассортимент и индивидуальный подход к клиентам являются основой для выстраивания долгосрочного и эффективного сотрудничества с предприятиями радиоэлектронной промышленности, предприятиями ВПК и научно-исследовательскими институтами России.

С нами вы становитесь еще успешнее!

Наши контакты:

Телефон: +7 812 627 14 35

Электронная почта: sales@st-electron.ru

Адрес: 198099, Санкт-Петербург,
Промышленная ул, дом № 19, литера Н,
помещение 100-Н Офис 331