

3-A SINK/SOURCE DDR TERMINATION REGULATOR

Check for Samples: [TPS51100](#)

FEATURES

- **Input Voltage Range: 4.75 V to 5.25 V**
- **VLDOIN Voltage Range: 1.2 V to 3.6 V**
- **3-A Sink/Source Termination Regulator Includes Droop Compensation**
- **Requires Only 20- μ F Ceramic Output Capacitance**
- **Supports High-Z in S3 and Soft-Off in S5**
- **1.2-V Input (VLDOIN) Helps Reduce Total Power Dissipation**
- **Integrated Divider Tracks 0.5 VDDQSNS for VTT and VTTREF**
- **Remote Sensing (VTTSENS)**
- **± 20 -mV Accuracy for VTT and VTTREF**
- **10-mA Buffered Reference (VTTREF)**
- **Built-In Soft-Start, UVLO and OCL**
- **Thermal Shutdown**
- **Supports JEDEC Specifications**

The TPS51100 is a 3-A sink/source tracking termination regulator. It is specifically designed for low-cost/low-external component count systems, where space is a premium.

The TPS51100 maintains fast transient response, only requiring 20 μ F (2 \times 10 μ F) of ceramic output capacitance. The TPS51100 supports remote sensing functions and all features required to power the DDR and DDR2 VTT bus termination according to the JEDEC specification. The part also supports DDR3 VTT termination with VDDQ at 1.5 V (typ). In addition, the TPS51100 includes integrated sleep-state controls, placing VTT in high-Z in S3 (suspend to RAM) and soft-off for VTT and VTTREF in S5 (suspend to disk). The TPS51100 is available in the thermally efficient 10-pin MSOP PowerPAD™ package and is specified from -40°C to 85°C .

ORDERING INFORMATION

T_A	PLASTIC MSOP PowerPAD™ PACKAGE (DGQ) ⁽¹⁾
-40°C to 85°C	TPS51100DGQ

APPLICATIONS

- **DDR, DDR2, DDR3 Memory Termination**
- **SSTL-2, SSTL-18 and HSTL Termination**

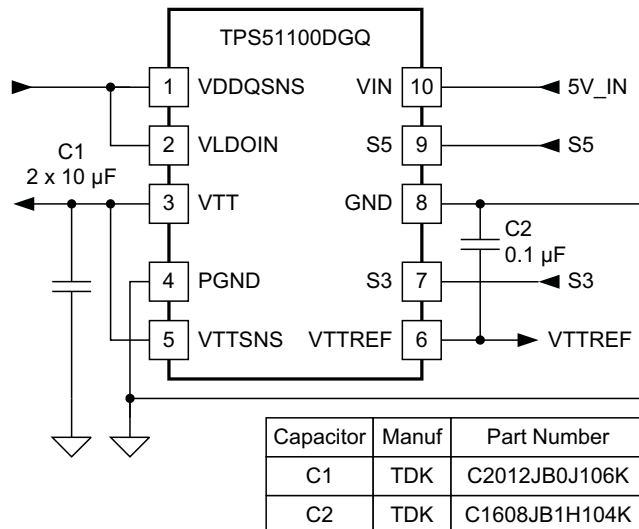

- (1) The DGQ package is also available taped and reeled. Add an R suffix to the device type (i.e., TPS51100DGQR). See the application section of the data sheet for the PowerPAD package drawing and layout information.



Please be aware that an important notice concerning availability, standard warranty, and use in critical applications of Texas Instruments semiconductor products and disclaimers thereto appears at the end of this data sheet.

PowerPAD is a trademark of Texas Instruments.

TPS51100

SLUS600D – APRIL 2004 – REVISED MAY 2012

www.ti.com



This integrated circuit can be damaged by ESD. Texas Instruments recommends that all integrated circuits be handled with appropriate precautions. Failure to observe proper handling and installation procedures can cause damage.

ESD damage can range from subtle performance degradation to complete device failure. Precision integrated circuits may be more susceptible to damage because very small parametric changes could cause the device not to meet its published specifications.

ABSOLUTE MAXIMUM RATINGS

over operating free-air temperature range (unless otherwise noted)⁽¹⁾

		VALUE	UNIT
Input voltage range ⁽²⁾	VIN, VLDOIN, VTTSNS, VDDQSNS, S3, S5	-0.3 to 6	V
	PGND	-0.3 to 0.3	
Output voltage range ⁽²⁾	VTT, VTTREF	-0.3 to 6	V
T _A	Operating ambient temperature range	-40 to 85	°C
T _{stg}	Storage temperature	-55 to 150	°C

- (1) Stresses beyond those listed under *absolute maximum ratings* may cause permanent damage to the device. These are stress ratings only, and functional operation of the device at these or any other conditions beyond those indicated under *recommended operating conditions* is not implied. Exposure to absolute-maximum-rated conditions for extended periods may affect device reliability.
- (2) All voltage values are with respect to the network ground terminal unless otherwise noted.

THERMAL INFORMATION

THERMAL METRIC ⁽¹⁾		TPS51100	UNITS
		DGQ 10 PINS	
θ _{JA}	Junction-to-ambient thermal resistance	60.3	°C/W
θ _{JCtop}	Junction-to-case (top) thermal resistance	63.5	
θ _{JB}	Junction-to-board thermal resistance	51.6	
ψ _{JT}	Junction-to-top characterization parameter	1.5	
ψ _{JB}	Junction-to-board characterization parameter	22.3	
θ _{JCbot}	Junction-to-case (bottom) thermal resistance	9.5	

- (1) For more information about traditional and new thermal metrics, see the *IC Package Thermal Metrics* application report, [SPRA953](#).

RECOMMENDED OPERATING CONDITIONS

over operating free-air temperature range (unless otherwise noted)

		MIN	MAX	UNIT
V _{IN}	Supply voltage	4.75	5.25	V
Voltage range	S3, S5	-0.10	5.25	V
	VLDOIN, VDDQSNS, VTT, VTTSNS	-0.1	3.6	
	VTTREF	-0.1	1.8	
	PGND	-0.1	0.1	
T _A	Operating free-air temperature	-40	85	°C

ELECTRICAL CHARACTERISTICS
 $T_A = -40^{\circ}\text{C}$ to 85°C , $V_{VIN} = 5\text{ V}$, VLDOIN and VDDQSNS are connected to 2.5 V (unless otherwise noted)

PARAMETER		TEST CONDITIONS	MIN	TYP	MAX	UNIT
SUPPLY CURRENT						
I_{VIN}	Supply current, VIN	$T_A = 25^{\circ}\text{C}$, $V_{VIN} = 5\text{ V}$, no load, $V_{S3} = V_{S5} = 5\text{ V}$	0.25	0.5	1	mA
I_{VINSTB}	Standby current, VIN	$T_A = 25^{\circ}\text{C}$, $V_{VIN} = 5\text{ V}$, no load, $V_{S3} = 0\text{ V}$, $V_{S5} = 5\text{ V}$	25	50	80	μA
I_{VINSN}	Shutdown current, VIN	$T_A = 25^{\circ}\text{C}$, $V_{VIN} = 5\text{ V}$, no load, $V_{S3} = V_{S5} = 0\text{ V}$, $V_{VLDOIN} = V_{VDDQSNS} = 0\text{ V}$		0.3	1	μA
I_{VLDOIN}	Supply current, VLDOIN	$T_A = 25^{\circ}\text{C}$, $V_{VIN} = 5\text{ V}$, no load, $V_{S3} = V_{S5} = 5\text{ V}$	0.7	1.2	2	mA
$I_{VLDOINSTB}$	Standby current, VLDOIN	$T_A = 25^{\circ}\text{C}$, $V_{VIN} = 5\text{ V}$, no load, $V_{S3} = 0\text{ V}$, $V_{S5} = 5\text{ V}$		6	10	μA
$I_{VLDOINSN}$	Shutdown current, VLDOIN	$T_A = 25^{\circ}\text{C}$, $V_{VIN} = 5\text{ V}$, no load, $V_{S3} = V_{S5} = 0\text{ V}$		0.3	1	μA
INPUT CURRENT						
$I_{VDDQSNS}$	Input current, VDDQSNS	$V_{VIN} = 5\text{ V}$, $V_{S3} = V_{S5} = 5\text{ V}$	1	3	5	μA
I_{VTTSNS}	Input current, VTTSNS	$V_{VIN} = 5\text{ V}$, $V_{S3} = V_{S5} = 5\text{ V}$	-1	-0.25	1	μA
VTT OUTPUT						
V_{VTTSNS}	Output voltage, VTT	$V_{VLDOIN} = V_{VDDQSNS} = 2.5\text{ V}$		1.25		V
		$V_{VLDOIN} = V_{VDDQSNS} = 1.8\text{ V}$		0.9		
		$V_{VLDOIN} = V_{VDDQSNS} = 1.5\text{ V}$		0.75		
$V_{VTTOL25}$	Output voltage tolerance to VTTREF, VTT	$V_{VLDOIN} = V_{VDDQSNS} = 2.5\text{ V}$, $ I_{VTT} = 0\text{ A}$	-20		20	mV
		$V_{VLDOIN} = V_{VDDQSNS} = 2.5\text{ V}$, $ I_{VTT} = 1.5\text{ A}$	-30		30	
		$V_{VLDOIN} = V_{VDDQSNS} = 2.5\text{ V}$, $ I_{VTT} = 3\text{ A}$	-40		40	
$V_{VLDOIN} = V_{VDDQSNS} = 1.8\text{ V}$, $ I_{VTT} = 0\text{ A}$		-20		20		
$V_{VLDOIN} = V_{VDDQSNS} = 1.8\text{ V}$, $ I_{VTT} = 1\text{ A}$		-30		30		
$V_{VLDOIN} = V_{VDDQSNS} = 1.8\text{ V}$, $ I_{VTT} = 2\text{ A}$		-40		40		
$V_{VLDOIN} = V_{VDDQSNS} = 1.5\text{ V}$, $ I_{VTT} = 0\text{ A}$		-20		20		
$V_{VLDOIN} = V_{VDDQSNS} = 1.5\text{ V}$, $ I_{VTT} = 1\text{ A}$		-30		30		
$V_{VTTOL18}$						
$V_{VTTOL15}$						
$I_{VTTCLSRC}$	Source current limit, VTT	$V_{TT} = \left(\frac{V_{VDDQSNS}}{2} \right) \times 0.95$, PGOOD = High	3	3.8	6	A
		$V_{VTT} = 0\text{ V}$	1.5	2.2	3	
$I_{VTTCLSNK}$	Sink current limit, VTT	$V_{TT} = \left(\frac{V_{VDDQSNS}}{2} \right) \times 1.05$, PGOOD = High	3	3.6	6	A
		$V_{VTT} = V_{VDDQ}$	1.5	2.2	3	
I_{VTTCLK}	Leakage current, VTT	$V_{TT} = \left(\frac{V_{VDDQSNS}}{2} \right) \times 1.25\text{ V}$, $T_A = 25^{\circ}\text{C}$	-1	0.5	10	μA
		$V_{S3} = 0\text{ V}$, $V_{S5} = 5\text{ V}$				
$I_{VTTSNSLK}$	Leakage current, VTTSNS	$V_{TT} = \left(\frac{V_{VDDQSNS}}{2} \right) \times 1.25\text{ V}$, $T_A = 25^{\circ}\text{C}$	-1	0.01	1	μA
I_{DSCHRG}	Discharge current, VTT	$T_A = 25^{\circ}\text{C}$, $V_{VDDQSNS} = 0\text{ V}$, $V_{S3} = V_{S5} = 0\text{ V}$, $V_{VTT} = 0.5\text{ V}$	10	17		mA
VTTREF OUTPUT						
V_{VTTREF}	Output voltage, VTTREF			$\frac{V_{VDDQSNS}}{2}$		V
$V_{VTTREFTOL25}$	Output voltage tolerance to VDDQSNS/2, VTTREF	$V_{VLDOIN} = V_{VDDQSNS} = 2.5\text{ V}$, $I_{VTTREF} < 10\text{ mA}$	-20		20	mV
$V_{VTTREFTOL18}$		$V_{VLDOIN} = V_{VDDQSNS} = 1.8\text{ V}$, $I_{VTTREF} < 10\text{ mA}$	-17		17	
$V_{VTTREFTOL15}$		$V_{VLDOIN} = V_{VDDQSNS} = 1.5\text{ V}$, $I_{VTTREF} < 10\text{ mA}$	-15		15	
$I_{VTTREFOCL}$	Source current limit, VTTREF	$V_{VTTREF} = 0\text{ V}$	10	20	30	mA

TPS51100

SLUS600D – APRIL 2004 – REVISED MAY 2012

www.ti.com

ELECTRICAL CHARACTERISTICS (continued)

$T_A = -40^{\circ}\text{C}$ to 85°C , $V_{VIN} = 5\text{ V}$, VLDOIN and VDDQSNS are connected to 2.5 V (unless otherwise noted)

PARAMETER		TEST CONDITIONS	MIN	TYP	MAX	UNIT
UVLO/LOGIC THRESHOLD						
V_{VINUV}	UVLO threshold voltage, V_{IN}	Wake up	3.4	3.7	4	V
		Hysteresis	0.15	0.25	0.35	
V_{IH}	High-level input voltage	S3, S5	1.6			V
V_{IL}	Low-level input voltage	S3, S5			0.3	V
V_{IHYST}	Hysteresis voltage	S3, S5		0.2		V
I_{LEAK}	Logic input leakage current	S2, S5, $T_A = 25^{\circ}\text{C}$	-1		1	μA
THERMAL SHUTDOWN						
T_{SDN}	Thermal shutdown threshold	Shutdown temperature		160		$^{\circ}\text{C}$
		Hysteresis		10		

DEVICE INFORMATION

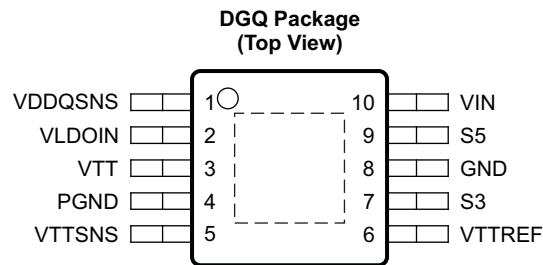

 Actual Size
 3,05 mm x 4,98 mm

P0083-01

NOTE: For more information on the DGQ package, see the *PowerPAD Thermally Enhanced Package* application report (SLMA002).

TERMINAL FUNCTIONS

TERMINAL		I/O	DESCRIPTION
NAME	NO.		
GND	8	–	Signal ground. Connect to negative terminal of the output capacitor
PGND	4	–	Power ground output for the VTT LDO
S3	7	I	S3 signal input
S5	9	I	S5 signal input
VDDQSNS	1	I	VDDQ sense input
VIN	10	I	5-V power supply
VLDOIN	2	I	Power supply for the VTT LDO and VTTREF output stage
VTT	3	O	Power output for the VTT LDO
VTTREF	6	O	VTT reference output. Connect to GND through 0.1- μF ceramic capacitor.
VTTSENS	5	I	Voltage sense input for the VTT LDO. Connect to plus terminal of the output capacitor.

SIMPLIFIED BLOCK DIAGRAM

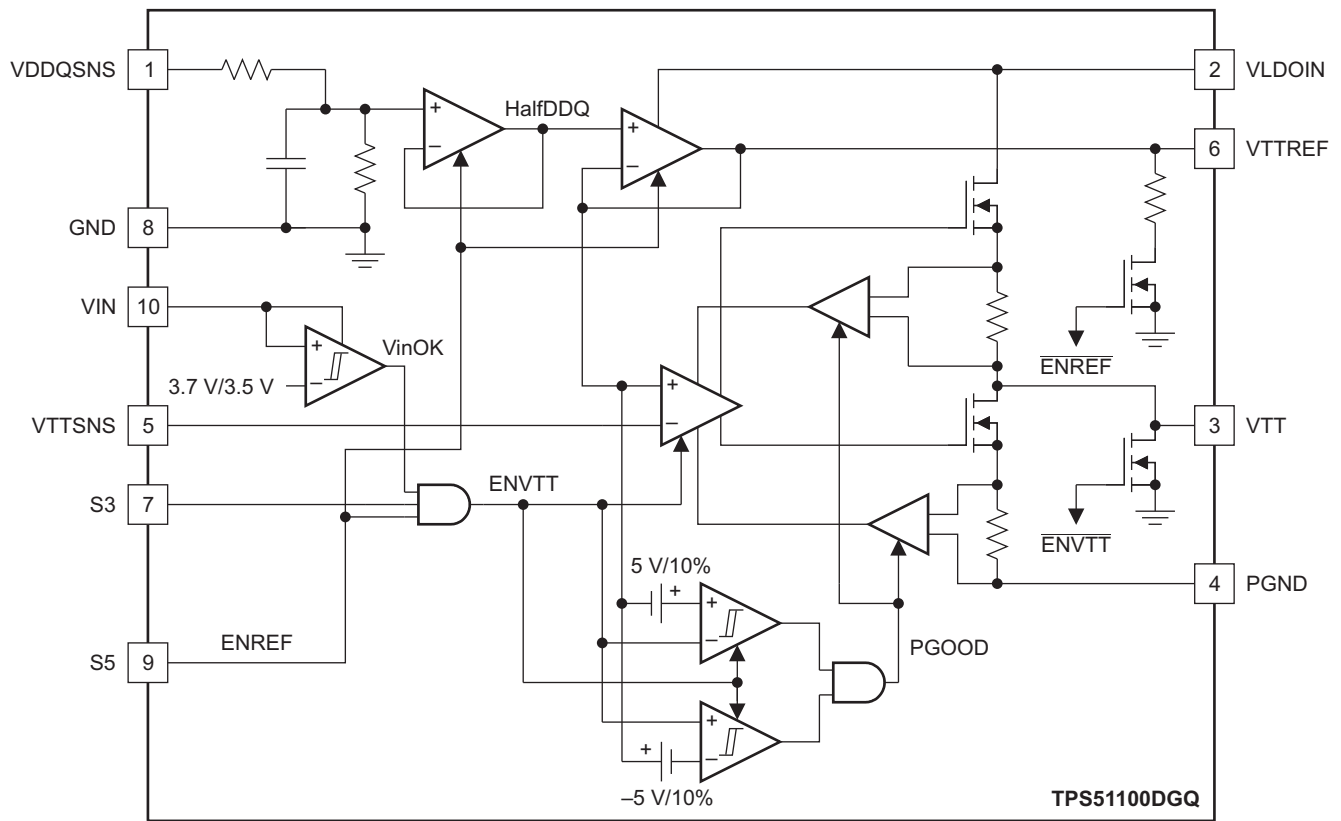

B0319-01

DETAILED DESCRIPTION

VTT SINK/SOURCE REGULATOR

The TPS51100 is a 3-A sink/source tracking termination regulator designed specially for low-cost, low-external-components systems where space is at premium, such as notebook PC applications. The TPS51100 integrates a high-performance, low-dropout linear regulator that is capable of sourcing and sinking current up to 3 A. This VTT linear regulator employs an ultimate fast-response feedback loop so that small ceramic capacitors are enough to keep tracking to the VTTREF within ± 40 mV under all conditions, including fast load transient. To achieve tight regulation with minimum effect of trace resistance, a remote sensing terminal, VTTSENS, should be connected to the positive node of the VTT output capacitor(s) as a separate trace from the high-current line from VTT.

VTTREF Regulator

The VTTREF block consists of an on-chip 1/2 divider, low-pass filter (LPF), and buffer. This regulator can source current up to 10 mA. Bypass VTTREF to GND using a 0.1- μ F ceramic capacitor to ensure stable operation.

Soft-Start

The soft-start function of the VTT is achieved via a current clamp, allowing the output capacitors to be charged with low and constant current that gives linear ramp-up of the output voltage. The current-limit threshold is changed in two stages using an internal powergood signal. When VTT is outside the powergood threshold, the current limit level is 2.2 A. When VTT rises above (VTTREF – 5%) or falls below (VTTREF + 5%), the current limit level switches to 3.8 A. The thresholds are typically VTTREF $\pm 5\%$ (from outside regulation to inside) and $\pm 10\%$ (when it falls outside). The soft-start function is completely symmetrical, and it works not only from GND to VTTREF voltage, but also from VDDQ to VTTREF voltage. Note that the VTT output is in a high-impedance state during the S3 state (S3 = low, S5 = high), and its voltage can be up to VDDQ voltage, depending on the external condition. Note that VTT does not start under a full-load condition.

S5 Control and Soft-Off

The S3 and S5 terminals should be connected to SLP_S3 and SLP_S5 signals, respectively. Both VTTREF and VTT are turned on at the S0 state (S3 = high, S5 = high). VTTREF is kept alive while VTT is turned off and left high-impedance in the S3 state (S3 = low, S5 = high). Both VTT and VTTREF outputs are turned off and discharged to ground through internal MOSFETs during S4/S5 state (both S3 and S5 are low).

Table 1. S3 and S5 Control Table

STATE	S3	S5	VTTREF	VTT
S0	H	H	1	1
S3 ⁽¹⁾	L	H	1	0 (high-Z)
S4/S5 ⁽¹⁾	L	L	0 (discharge)	0 (discharge)

(1) In case S3 is forced to H and S5 to L, VTTREF is discharged and VTT is at High-Z state. This condition is NOT recommended.

VTT Current Protection

The LDO has a constant overcurrent limit (OCL) at 3.8 A. This trip point is reduced to 2.2 A before the output voltage comes within $\pm 5\%$ of the target voltage or goes outside of $\pm 10\%$ of the target voltage.

VIN UVLO Protection

For VIN undervoltage lockout (UVLO) protection, the TPS51100 monitors VIN voltage. When the VIN voltage is lower than UVLO threshold voltage, the VTT regulator is shut off. This is a non-latch protection.

Thermal Shutdown

TPS51100 monitors its temperature. If the temperature exceeds the threshold value, typically 160°C, the VTT and VTTREF regulators are shut off. This is also a non-latch protection.

Output Capacitor

For stable operation, total capacitance of the VTT output terminal can be equal to or greater than 20 μF . Attach two 10- μF ceramic capacitors in parallel to minimize the effect of ESR and ESL. If the ESR is greater than 2 m Ω , insert an R-C filter between the output and the VTTSENS input to achieve loop stability. The R-C filter time constant should be almost the same or slightly lower than the time constant of the output capacitor and its ESR.

Soft-start duration, t_{SS} , is also a function of this output capacitance. Where $I_{\text{TTOCL}} = 2.2 \text{ A}$ (typ), t_{SS} can be calculated as,

$$t_{\text{SS}} = \left(\frac{C_{\text{OUT}} \times V_{\text{VTT}}}{I_{\text{TTOCL}}} \right) \quad (1)$$

Input Capacitor

Depending on the trace impedance between the VLDOIN bulk power supply to the part, transient increase of source current is supplied mostly by the charge from the VLDOIN input capacitor. Use a 10- μF (or more) ceramic capacitor to supply this transient charge. Provide more input capacitance as more output capacitance is used at VTT. In general, use 1/2 C_{OUT} for the input.

VIN Capacitor

Add a ceramic capacitor with a value between 1 μF and 4.7 μF placed close to the VIN pin, to stabilize 5 V from any parasitic impedance from the supply.

Thermal Design

As the TPS51100 is a linear regulator, the VTT current flow in both source and sink directions generates power dissipation from the device. In the source phase, the potential difference between V_{VLDOIN} and V_{VTT} times VTT current becomes the power dissipation, W_{DSRC} .

$$W_{\text{DSRC}} = (V_{\text{VLDOIN}} - V_{\text{VTT}}) \times I_{\text{VTT}} \quad (2)$$

In this case, if VLDOIN is connected to an alternative power supply lower than V_{DDQ} voltage, power loss can be decreased.

For the sink phase, VTT voltage is applied across the internal LDO regulator, and the power dissipation, and W_{DSNK} , is calculated by:

$$W_{\text{DSNK}} = V_{\text{VTT}} \times I_{\text{VTT}} \quad (3)$$

Because the device does not sink and source the current at the same time and I_{VTT} varies rapidly with time, the actual power dissipation that must be considered for thermal design is an average over the thermal relaxation duration of the system. Another power consumption is the current used for internal control circuitry from the VIN supply and VLDOIN supply. This can be estimated as 20 mW or less at normal operational conditions. This power must be effectively dissipated from the package. Maximum power dissipation allowed to the package is calculated by,

$$W_{\text{PKG}} = \frac{(T_{\text{J(max)}} - T_{\text{A(max)}})}{\theta_{\text{JA}}} \quad (4)$$

where

$T_{\text{J(max)}}$ is 125°C

$T_{\text{A(max)}}$ is the maximum ambient temperature in the system

θ_{JA} is the thermal resistance from the silicon junction to the ambient

This thermal resistance strongly depends on the board layout. TPS51100 is assembled in a thermally enhanced PowerPAD package that has an exposed die pad underneath the body. For improved thermal performance, this die pad must be attached to the ground trace via thermal land on the PCB. This ground trace acts as a heat sink/spread. The typical thermal resistance, 57.7°C/W, is achieved based on a 3 mm \times 2 mm thermal land with two vias without air flow. It can be improved by using larger thermal land and/or increasing the number of vias. For example, assuming a 3 mm \times 3 mm thermal land with four vias without air flow, it is 45.4°C/W. Further information about the PowerPAD package and its recommended board layout is described in the *PowerPAD Thermally Enhanced Package* application report (SLMA002). This document is available at www.ti.com.

LAYOUT CONSIDERATIONS

Consider the following points before the layout of TPS51100 design begins.

- The input bypass capacitor for VLDOIN should be placed to the pin as close as possible with a short and wide connection.
- The output capacitor for VTT should be placed close to the pin with a short and wide connection in order to avoid additional ESR and/or ESL of the trace.
- VTTSENS should be connected to the positive node of VTT output capacitor(s) as a separate trace from the high current power line and is strongly recommended to avoid additional ESR and/or ESL. If it is needed to sense the voltage of the point of the load, it is recommended to attach the output capacitor(s) at that point. Also, it is recommended to minimize any additional ESR and/or ESL of the ground trace between the GND pin and the output capacitor(s).
- Consider adding an LPF at VTTSENS in case the ESR of the VTT output capacitor(s) is larger than 2 m Ω .
- VDDQSNS can be connected separately from VLDOIN. Remember that this sensing potential is the reference voltage of VTTREF. Avoid any noise generative lines.
- The negative node of the VTT output capacitor(s) and the VTTREF capacitor should be tied together, avoiding common impedance to the high-current path of the VTT source/sink current.
- The GND (signal GND) pin node represents the reference potential for the VTTREF and VTT outputs. Connect GND to the negative nodes of the VTT capacitor(s), VTTREF capacitor, and VDDQ capacitor(s) with care to avoid additional ESR and/or ESL. GND and PGND (Power GND) should be isolated, with a single point connection between them.
- In order to remove heat from the package effectively, prepare the thermal land and solder to the package thermal pad. The wide trace of the component-side copper, connected to this thermal land, helps heat spreading. Numerous vias 0.33 mm in diameter connected from the thermal land to the internal/solder-side ground plane(s) should be used to help dissipation.

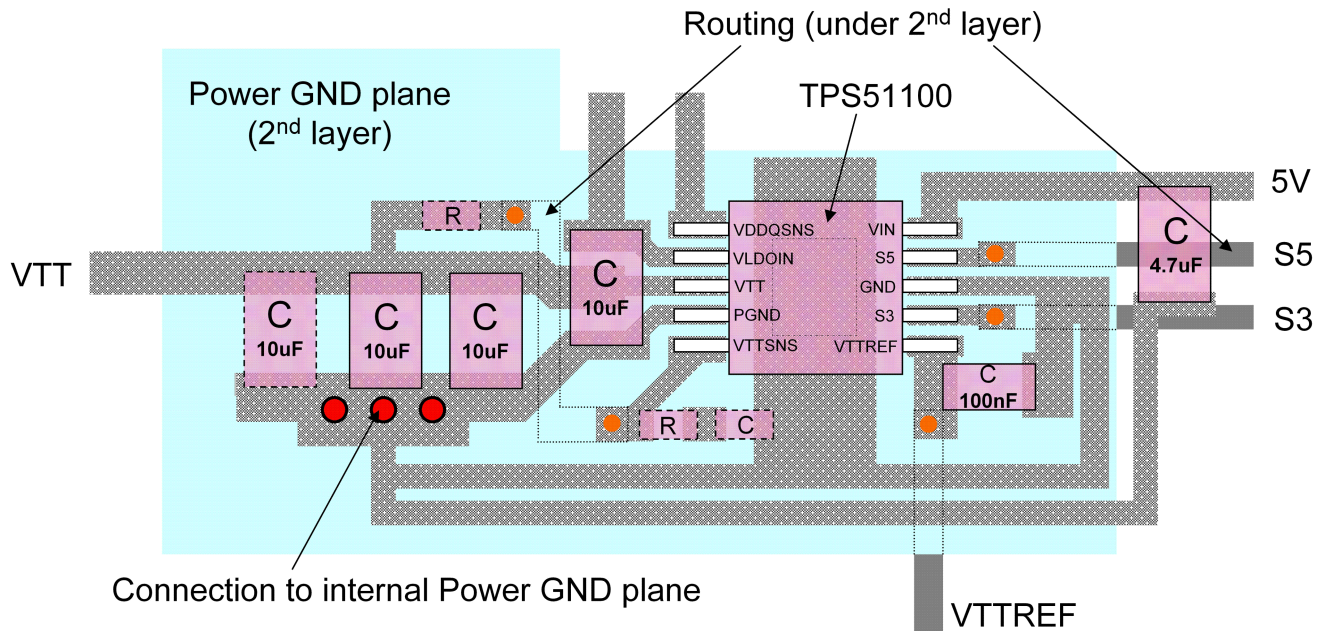

M0118-01

- NOTES:
1. The positive terminal of each output capacitor should be directly connected to VTT of the IC; do not use a VIA.
 2. The negative terminal of each output capacitor should be directly connected to GND of the IC; do not use a VIA.
 3. VIAs
 - VIA between 1st and 2nd layers
 - VIA between 1st and other layers under 2nd
 4. Rs and Cs with dotted outlines are options.

Figure 1. TPS51100 PCB Layout Guideline

TYPICAL CHARACTERISTICS

VIN SUPPLY CURRENT
vs
TEMPERATURE

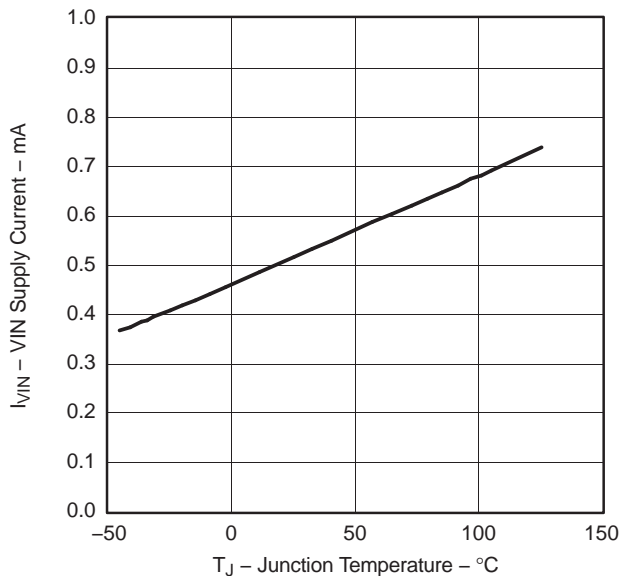

Figure 2.

G001

VIN SHUTDOWN CURRENT
vs
TEMPERATURE

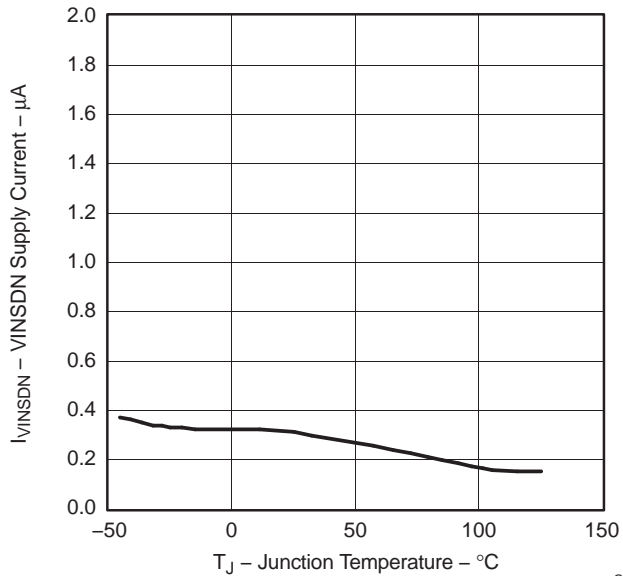

Figure 3.

G002

VIN SUPPLY CURRENT
vs
VTT LOAD CURRENT

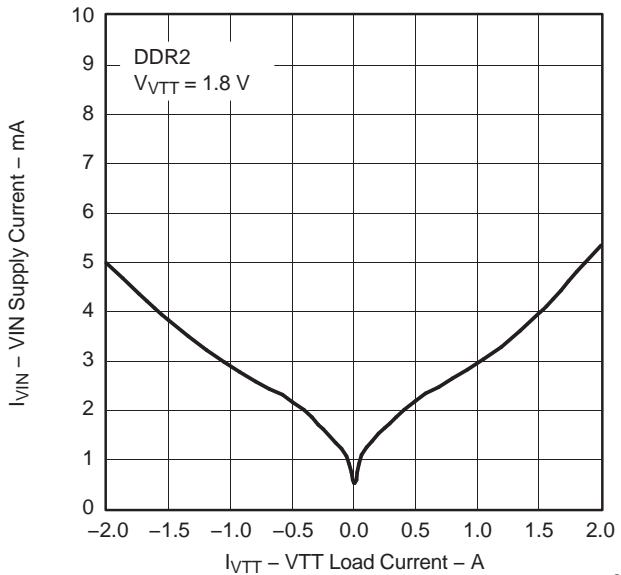

Figure 4.

G003

VLDOIN SUPPLY CURRENT
vs
TEMPERATURE

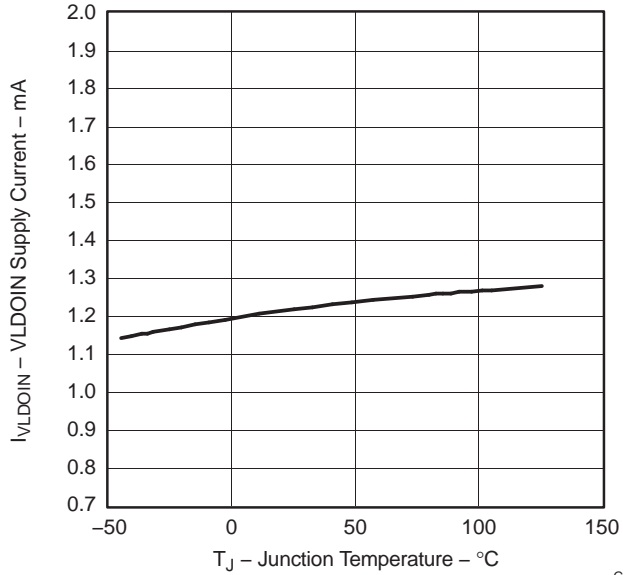

Figure 5.

G004

TYPICAL CHARACTERISTICS (continued)

VLD0IN SHUTDOWN CURRENT
vs
TEMPERATURE

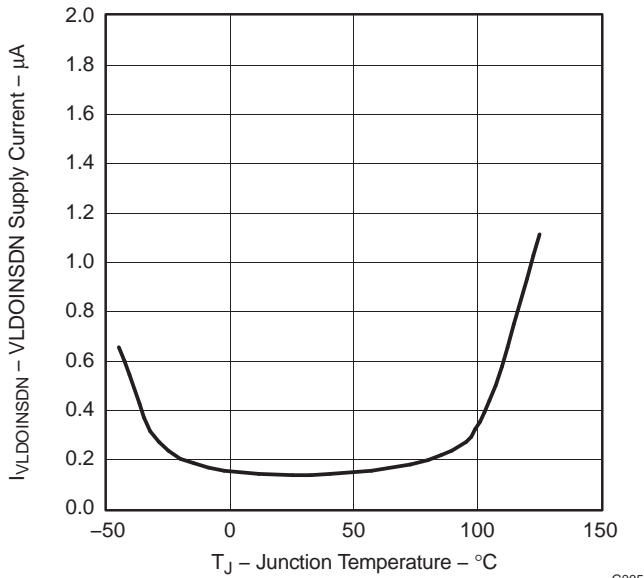

Figure 6.

G005

DISCHARGE CURRENT
vs
TEMPERATURE

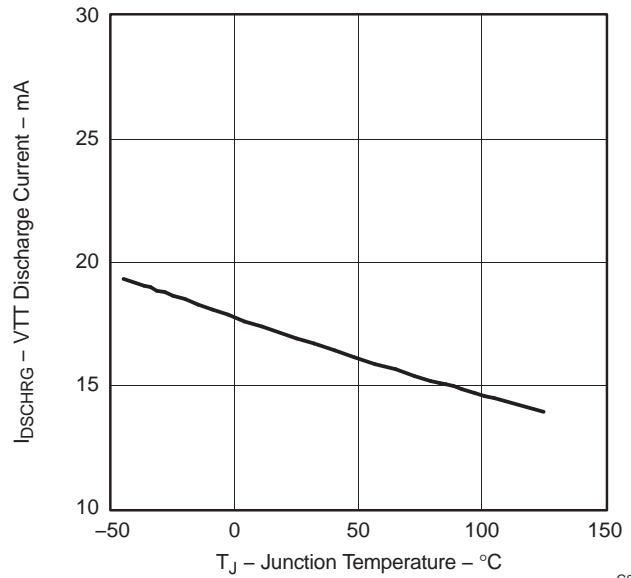

Figure 7.

G006

VTT VOLTAGE LOAD REGULATION
vs
VTT LOAD CURRENT (DDR)

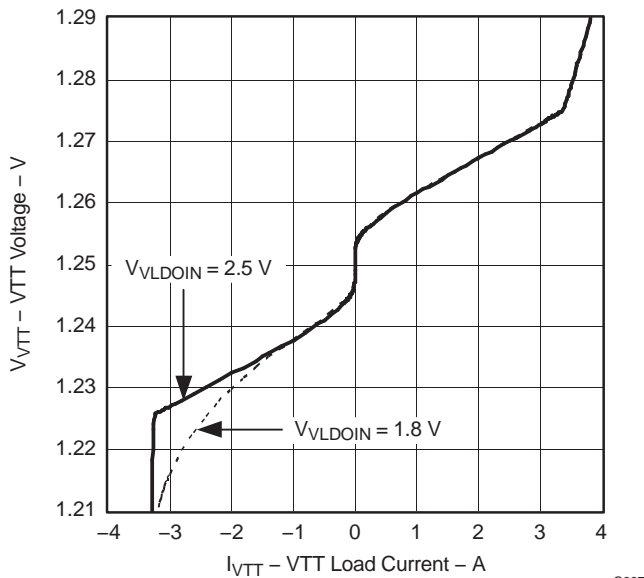

Figure 8.

G007

VTT VOLTAGE LOAD REGULATION
vs
VTT LOAD CURRENT (DDR2)

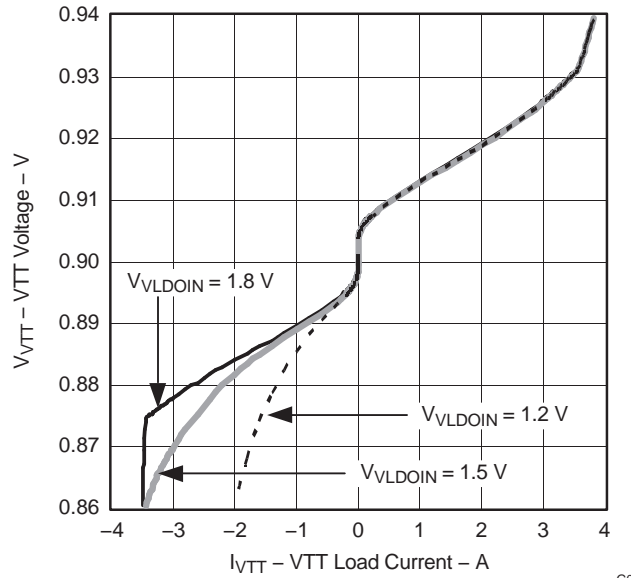

Figure 9.

G008

TYPICAL CHARACTERISTICS (continued)

VTT VOLTAGE LOAD REGULATION
vs
VTT LOAD CURRENT (DDR3)

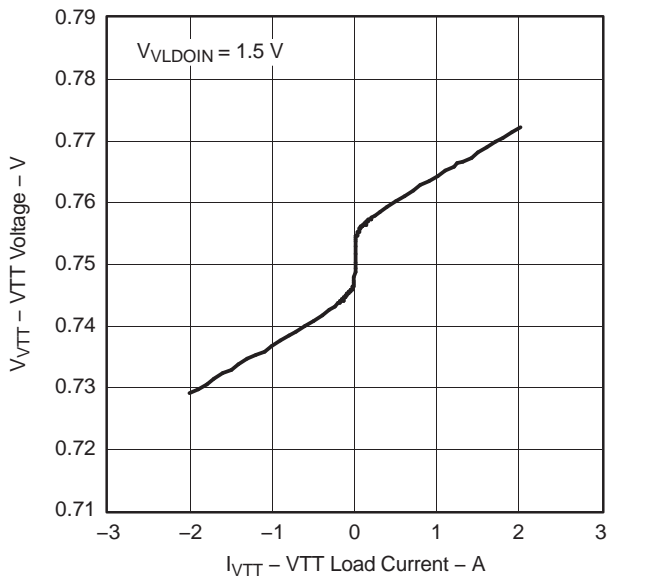

Figure 10.

G009

VTTREF VOLTAGE LOAD REGULATION
vs
VTTREF LOAD CURRENT (DDR)

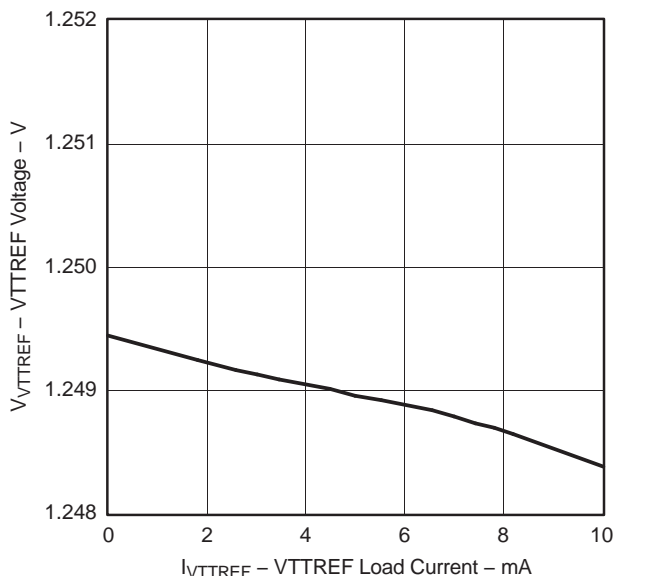

Figure 11.

G010

VTTREF VOLTAGE LOAD REGULATION
vs
VTTREF LOAD CURRENT (DDR2)

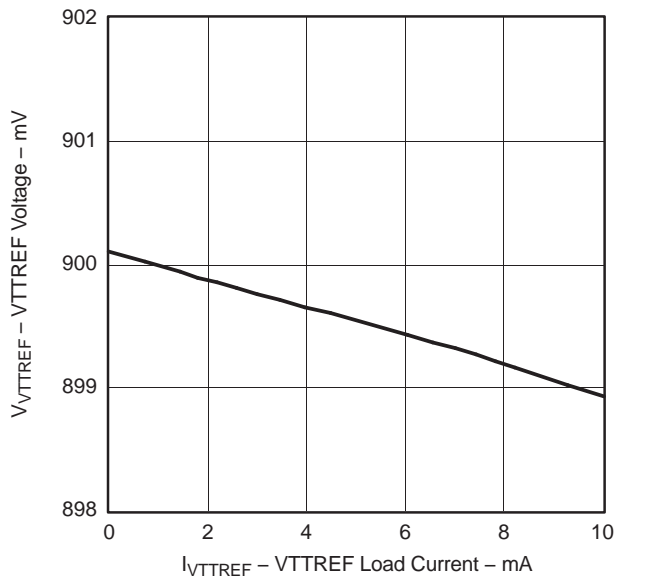

Figure 12.

G011

VTTREF VOLTAGE LOAD REGULATION
vs
VTTREF LOAD CURRENT (DDR3)

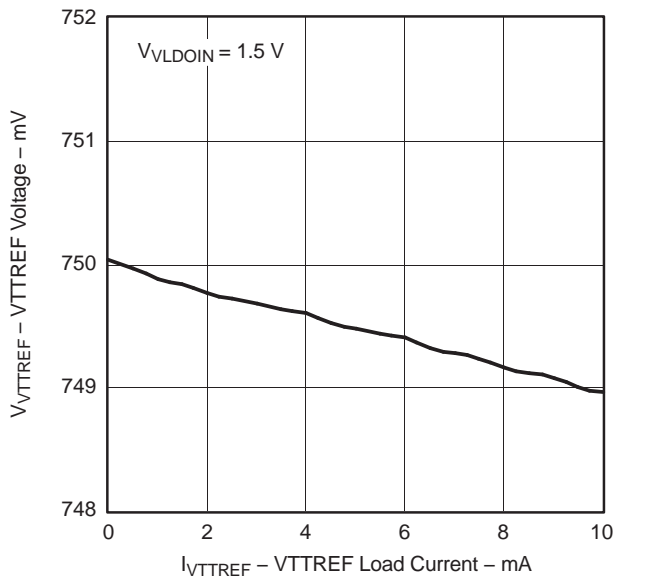
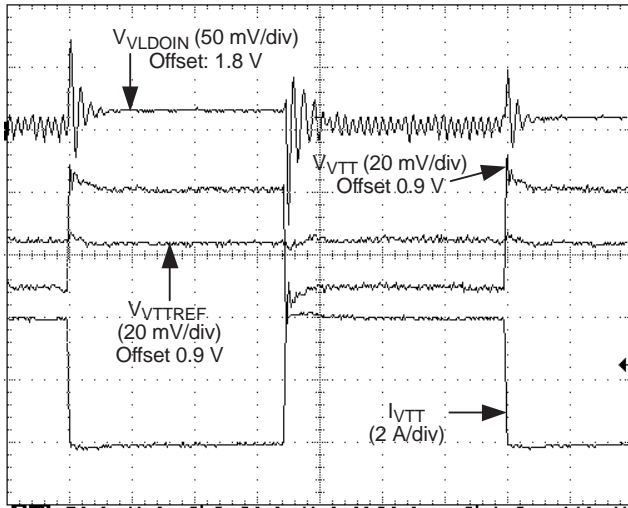

Figure 13.

G012

TYPICAL CHARACTERISTICS (continued)

VTT VOLTAGE LOAD TRANSIENT RESPONSE



t - Time - 20 μs/div

G013

Figure 14.

STARTUP WAVEFORMS S5 LOW-TO-HIGH

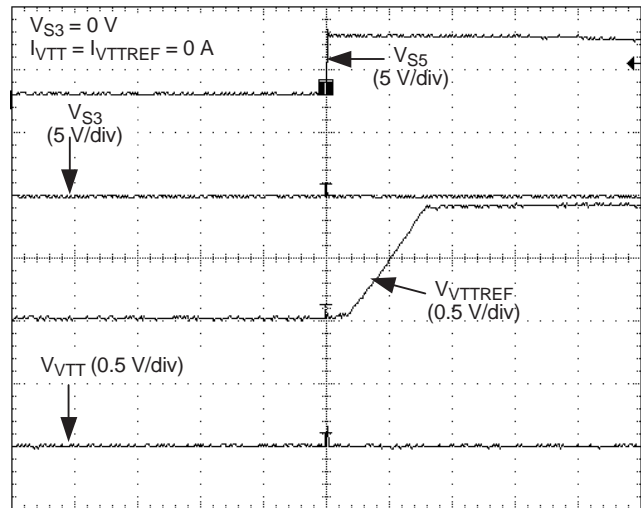

t - Time - 10 μs/div

G014

Figure 15.

STARTUP WAVEFORMS S3 LOW-TO-HIGH

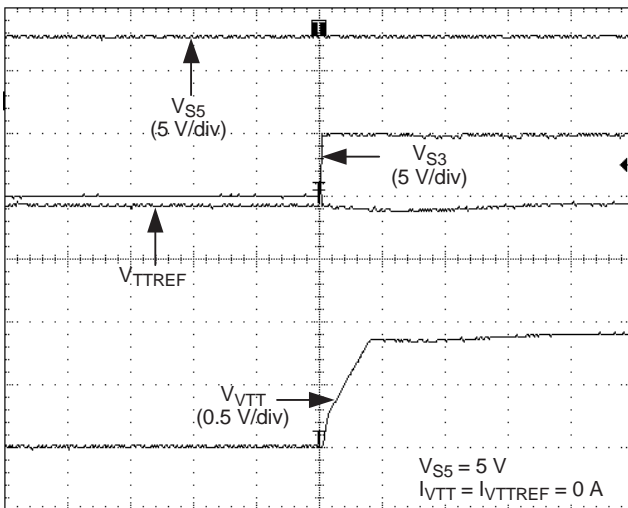

t - Time - 10 μs/div

G015

Figure 16.

SHUTDOWN WAVEFORMS S3 HIGH-TO-LOW

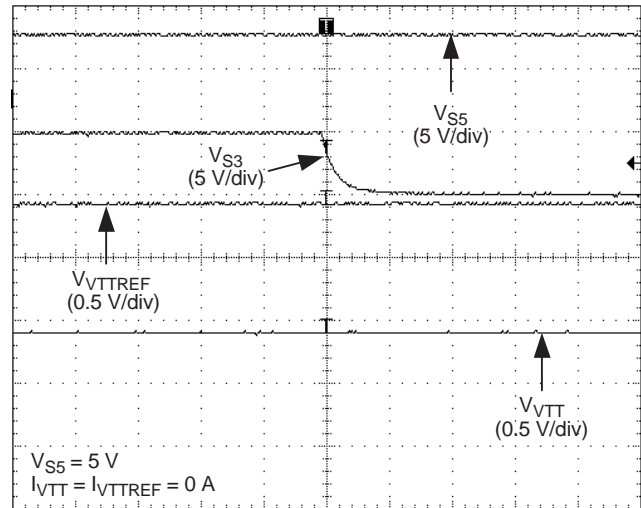

t - Time - 1 ms/div

G016

Figure 17.

TYPICAL CHARACTERISTICS (continued)

SHUTDOWN WAVEFORMS
S3 AND S5 HIGH-TO-LOW

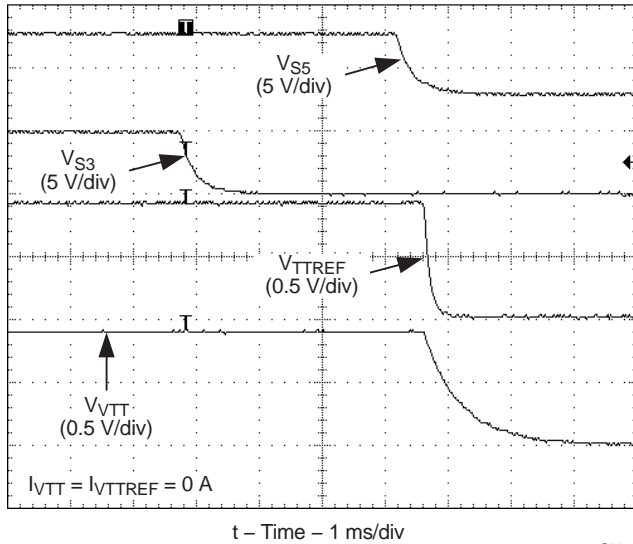

Figure 18.

G017

BODE PLOT DDR SOURCE

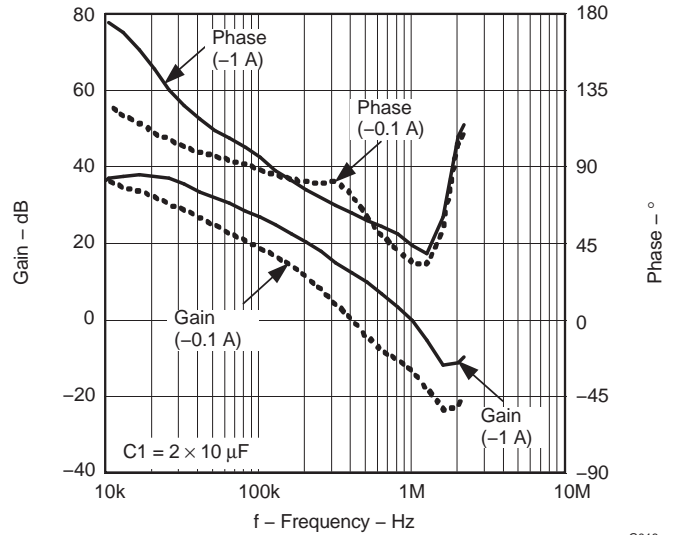

Figure 19.

G018

BODE PLOT DDR SINK

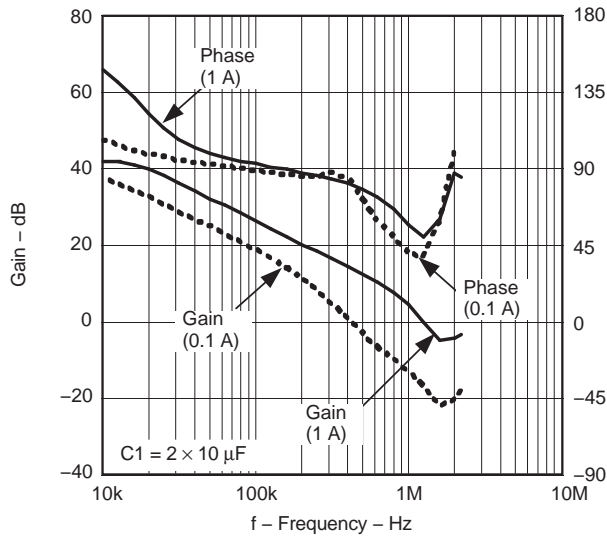

Figure 20.

G019

BODE PLOT DDR2 SOURCE

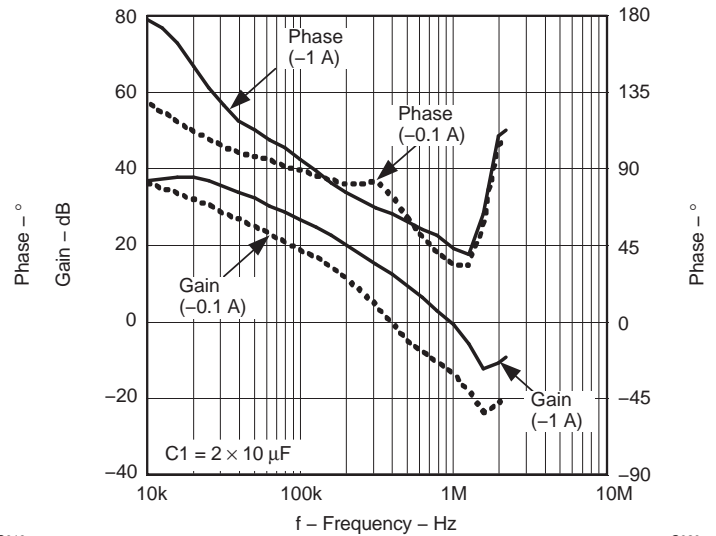

Figure 21.

G020

TYPICAL CHARACTERISTICS (continued)
BODE PLOT DDR2 SINK

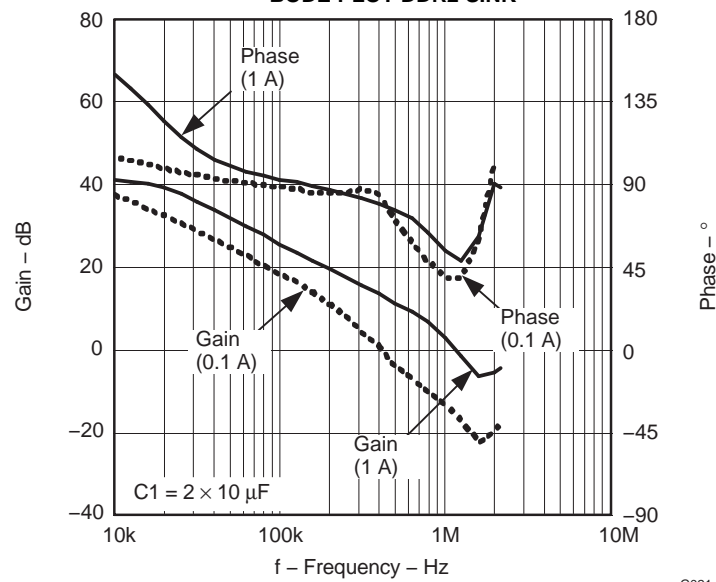

Figure 22.

G021

Changes from Revision C (JUNE 2008) to Revision D**Page**

-
- Added updated Thermal data [2](#)
-

PACKAGING INFORMATION

Orderable Device	Status ⁽¹⁾	Package Type	Package Drawing	Pins	Package Qty	Eco Plan ⁽²⁾	Lead/ Ball Finish	MSL Peak Temp ⁽³⁾	Samples (Requires Login)
TPS51100DGQ	ACTIVE	MSOP- PowerPAD	DGQ	10	80	Green (RoHS & no Sb/Br)	CU NIPDAUAG	Level-1-260C-UNLIM	
TPS51100DGQG4	ACTIVE	MSOP- PowerPAD	DGQ	10	80	Green (RoHS & no Sb/Br)	CU NIPDAUAG	Level-1-260C-UNLIM	
TPS51100DGQR	ACTIVE	MSOP- PowerPAD	DGQ	10	2500	Green (RoHS & no Sb/Br)	CU NIPDAUAG	Level-1-260C-UNLIM	
TPS51100DGQRG4	ACTIVE	MSOP- PowerPAD	DGQ	10	2500	Green (RoHS & no Sb/Br)	CU NIPDAUAG	Level-1-260C-UNLIM	

⁽¹⁾ The marketing status values are defined as follows:

ACTIVE: Product device recommended for new designs.

LIFEBUY: TI has announced that the device will be discontinued, and a lifetime-buy period is in effect.

NRND: Not recommended for new designs. Device is in production to support existing customers, but TI does not recommend using this part in a new design.

PREVIEW: Device has been announced but is not in production. Samples may or may not be available.

OBSOLETE: TI has discontinued the production of the device.

⁽²⁾ Eco Plan - The planned eco-friendly classification: Pb-Free (RoHS), Pb-Free (RoHS Exempt), or Green (RoHS & no Sb/Br) - please check <http://www.ti.com/productcontent> for the latest availability information and additional product content details.

TBD: The Pb-Free/Green conversion plan has not been defined.

Pb-Free (RoHS): TI's terms "Lead-Free" or "Pb-Free" mean semiconductor products that are compatible with the current RoHS requirements for all 6 substances, including the requirement that lead not exceed 0.1% by weight in homogeneous materials. Where designed to be soldered at high temperatures, TI Pb-Free products are suitable for use in specified lead-free processes.

Pb-Free (RoHS Exempt): This component has a RoHS exemption for either 1) lead-based flip-chip solder bumps used between the die and package, or 2) lead-based die adhesive used between the die and leadframe. The component is otherwise considered Pb-Free (RoHS compatible) as defined above.

Green (RoHS & no Sb/Br): TI defines "Green" to mean Pb-Free (RoHS compatible), and free of Bromine (Br) and Antimony (Sb) based flame retardants (Br or Sb do not exceed 0.1% by weight in homogeneous material)

⁽³⁾ MSL, Peak Temp. -- The Moisture Sensitivity Level rating according to the JEDEC industry standard classifications, and peak solder temperature.

Important Information and Disclaimer: The information provided on this page represents TI's knowledge and belief as of the date that it is provided. TI bases its knowledge and belief on information provided by third parties, and makes no representation or warranty as to the accuracy of such information. Efforts are underway to better integrate information from third parties. TI has taken and continues to take reasonable steps to provide representative and accurate information but may not have conducted destructive testing or chemical analysis on incoming materials and chemicals. TI and TI suppliers consider certain information to be proprietary, and thus CAS numbers and other limited information may not be available for release.

In no event shall TI's liability arising out of such information exceed the total purchase price of the TI part(s) at issue in this document sold by TI to Customer on an annual basis.

TAPE AND REEL INFORMATION
REEL DIMENSIONS

TAPE DIMENSIONS

A0	Dimension designed to accommodate the component width
B0	Dimension designed to accommodate the component length
K0	Dimension designed to accommodate the component thickness
W	Overall width of the carrier tape
P1	Pitch between successive cavity centers

TAPE AND REEL INFORMATION

*All dimensions are nominal

Device	Package Type	Package Drawing	Pins	SPQ	Reel Diameter (mm)	Reel Width W1 (mm)	A0 (mm)	B0 (mm)	K0 (mm)	P1 (mm)	W (mm)	Pin1 Quadrant
TPS51100DGQR	MSOP-Power PAD	DGQ	10	2500	330.0	12.4	5.3	3.4	1.4	8.0	12.0	Q1

TAPE AND REEL BOX DIMENSIONS



*All dimensions are nominal

Device	Package Type	Package Drawing	Pins	SPQ	Length (mm)	Width (mm)	Height (mm)
TPS51100DGQR	MSOP-PowerPAD	DGQ	10	2500	364.0	364.0	27.0

DGQ (S-PDSO-G10)

PowerPAD™ PLASTIC SMALL OUTLINE

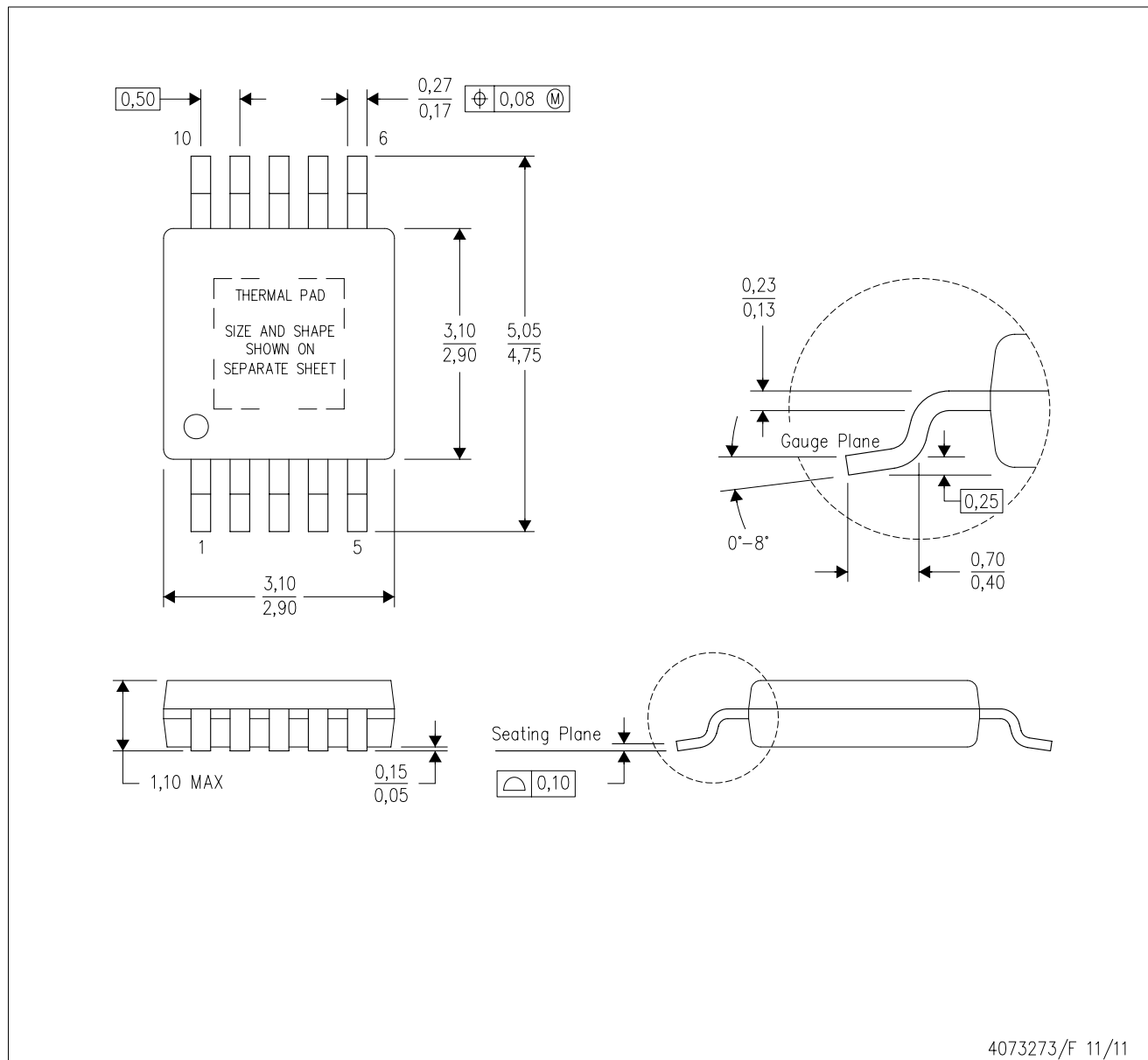

- NOTES:
- All linear dimensions are in millimeters.
 - This drawing is subject to change without notice.
 - Body dimensions do not include mold flash or protrusion not to exceed 0,15.
 - This package is designed to be soldered to a thermal pad on the board. Refer to Technical Brief, PowerPad Thermally Enhanced Package, Texas Instruments Literature No. SLMA002 for information regarding recommended board layout. This document is available at www.ti.com <<http://www.ti.com>>.
 - See the additional figure in the Product Data Sheet for details regarding the exposed thermal pad features and dimensions.
 - Falls within JEDEC MO-187 variation BA-T.

PowerPAD is a trademark of Texas Instruments.

THERMAL PAD MECHANICAL DATA

DGQ (S-PDSO-G10)

PowerPAD™ PLASTIC SMALL OUTLINE

THERMAL INFORMATION

This PowerPAD™ package incorporates an exposed thermal pad that is designed to be attached to a printed circuit board (PCB). The thermal pad must be soldered directly to the PCB. After soldering, the PCB can be used as a heatsink. In addition, through the use of thermal vias, the thermal pad can be attached directly to the appropriate copper plane shown in the electrical schematic for the device, or alternatively, can be attached to a special heatsink structure designed into the PCB. This design optimizes the heat transfer from the integrated circuit (IC).

For additional information on the PowerPAD package and how to take advantage of its heat dissipating abilities, refer to Technical Brief, PowerPAD Thermally Enhanced Package, Texas Instruments Literature No. SLMA002 and Application Brief, PowerPAD Made Easy, Texas Instruments Literature No. SLMA004. Both documents are available at www.ti.com.

The exposed thermal pad dimensions for this package are shown in the following illustration.

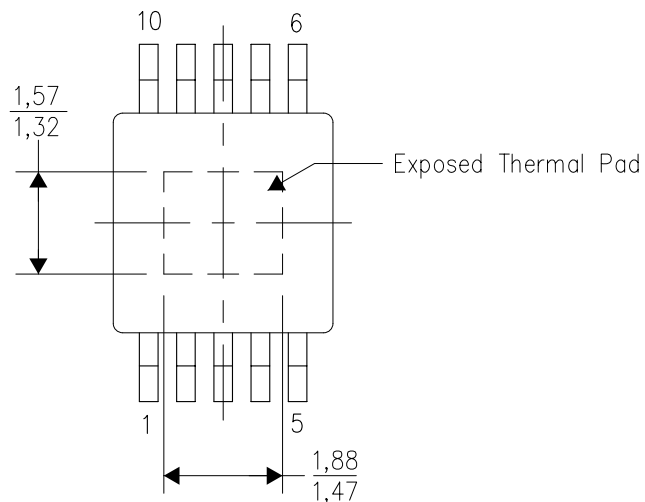

Top View

Exposed Thermal Pad Dimensions

4206324-2/F 01/11

NOTE: A. All linear dimensions are in millimeters

PowerPAD is a trademark of Texas Instruments

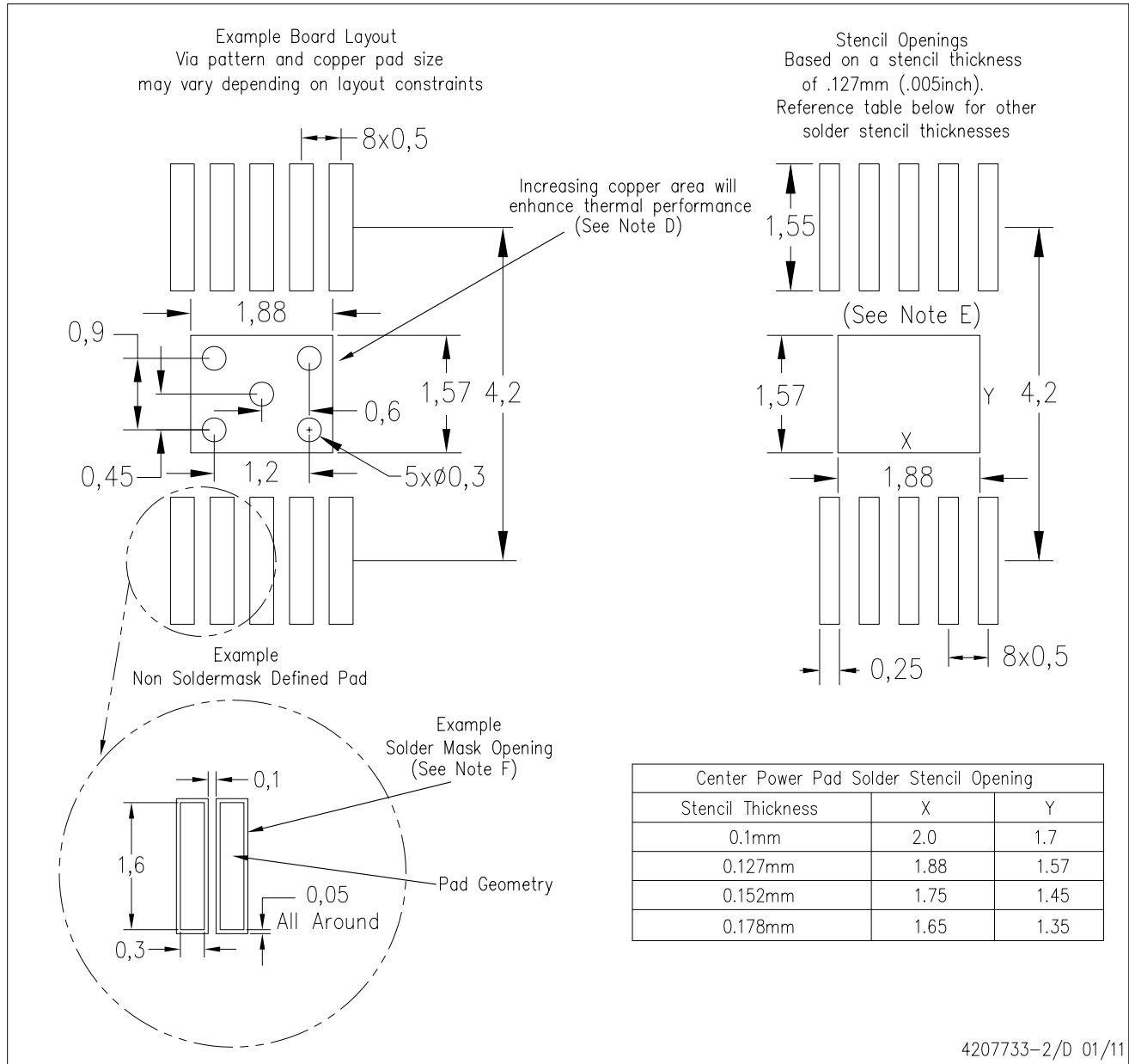

- NOTES:
- All linear dimensions are in millimeters.
 - This drawing is subject to change without notice.
 - Customers should place a note on the circuit board fabrication drawing not to alter the center solder mask defined pad.
 - This package is designed to be soldered to a thermal pad on the board. Refer to Technical Brief, PowerPad Thermally Enhanced Package, Texas Instruments Literature No. SLMA002, SLMA004, and also the Product Data Sheets for specific thermal information, via requirements, and recommended board layout. These documents are available at www.ti.com <<http://www.ti.com>>. Publication IPC-7351 is recommended for alternate designs.
 - Laser cutting apertures with trapezoidal walls and also rounding corners will offer better paste release. Customers should contact their board assembly site for stencil design recommendations. Example stencil design based on a 50% volumetric metal load solder paste. Refer to IPC-7525 for other stencil recommendations.
 - Customers should contact their board fabrication site for solder mask tolerances between and around signal pads.

PowerPAD is a trademark of Texas Instruments

IMPORTANT NOTICE

Texas Instruments Incorporated and its subsidiaries (TI) reserve the right to make corrections, modifications, enhancements, improvements, and other changes to its products and services at any time and to discontinue any product or service without notice. Customers should obtain the latest relevant information before placing orders and should verify that such information is current and complete. All products are sold subject to TI's terms and conditions of sale supplied at the time of order acknowledgment.

TI warrants performance of its hardware products to the specifications applicable at the time of sale in accordance with TI's standard warranty. Testing and other quality control techniques are used to the extent TI deems necessary to support this warranty. Except where mandated by government requirements, testing of all parameters of each product is not necessarily performed.

TI assumes no liability for applications assistance or customer product design. Customers are responsible for their products and applications using TI components. To minimize the risks associated with customer products and applications, customers should provide adequate design and operating safeguards.

TI does not warrant or represent that any license, either express or implied, is granted under any TI patent right, copyright, mask work right, or other TI intellectual property right relating to any combination, machine, or process in which TI products or services are used. Information published by TI regarding third-party products or services does not constitute a license from TI to use such products or services or a warranty or endorsement thereof. Use of such information may require a license from a third party under the patents or other intellectual property of the third party, or a license from TI under the patents or other intellectual property of TI.

Reproduction of TI information in TI data books or data sheets is permissible only if reproduction is without alteration and is accompanied by all associated warranties, conditions, limitations, and notices. Reproduction of this information with alteration is an unfair and deceptive business practice. TI is not responsible or liable for such altered documentation. Information of third parties may be subject to additional restrictions.

Resale of TI products or services with statements different from or beyond the parameters stated by TI for that product or service voids all express and any implied warranties for the associated TI product or service and is an unfair and deceptive business practice. TI is not responsible or liable for any such statements.

TI products are not authorized for use in safety-critical applications (such as life support) where a failure of the TI product would reasonably be expected to cause severe personal injury or death, unless officers of the parties have executed an agreement specifically governing such use. Buyers represent that they have all necessary expertise in the safety and regulatory ramifications of their applications, and acknowledge and agree that they are solely responsible for all legal, regulatory and safety-related requirements concerning their products and any use of TI products in such safety-critical applications, notwithstanding any applications-related information or support that may be provided by TI. Further, Buyers must fully indemnify TI and its representatives against any damages arising out of the use of TI products in such safety-critical applications.

TI products are neither designed nor intended for use in military/aerospace applications or environments unless the TI products are specifically designated by TI as military-grade or "enhanced plastic." Only products designated by TI as military-grade meet military specifications. Buyers acknowledge and agree that any such use of TI products which TI has not designated as military-grade is solely at the Buyer's risk, and that they are solely responsible for compliance with all legal and regulatory requirements in connection with such use.

TI products are neither designed nor intended for use in automotive applications or environments unless the specific TI products are designated by TI as compliant with ISO/TS 16949 requirements. Buyers acknowledge and agree that, if they use any non-designated products in automotive applications, TI will not be responsible for any failure to meet such requirements.

Following are URLs where you can obtain information on other Texas Instruments products and application solutions:

Products

Audio	www.ti.com/audio
Amplifiers	amplifier.ti.com
Data Converters	dataconverter.ti.com
DLP® Products	www.dlp.com
DSP	dsp.ti.com
Clocks and Timers	www.ti.com/clocks
Interface	interface.ti.com
Logic	logic.ti.com
Power Mgmt	power.ti.com
Microcontrollers	microcontroller.ti.com
RFID	www.ti-rfid.com
OMAP Mobile Processors	www.ti.com/omap
Wireless Connectivity	www.ti.com/wirelessconnectivity

Applications

Automotive and Transportation	www.ti.com/automotive
Communications and Telecom	www.ti.com/communications
Computers and Peripherals	www.ti.com/computers
Consumer Electronics	www.ti.com/consumer-apps
Energy and Lighting	www.ti.com/energy
Industrial	www.ti.com/industrial
Medical	www.ti.com/medical
Security	www.ti.com/security
Space, Avionics and Defense	www.ti.com/space-avionics-defense
Video and Imaging	www.ti.com/video

TI E2E Community Home Page

e2e.ti.com

Mailing Address: Texas Instruments, Post Office Box 655303, Dallas, Texas 75265
Copyright © 2012, Texas Instruments Incorporated



Стандарт Электрон Связь

Мы молодая и активно развивающаяся компания в области поставок электронных компонентов. Мы поставляем электронные компоненты отечественного и импортного производства напрямую от производителей и с крупнейших складов мира.

Благодаря сотрудничеству с мировыми поставщиками мы осуществляем комплексные и плановые поставки широчайшего спектра электронных компонентов.

Собственная эффективная логистика и склад в обеспечивает надежную поставку продукции в точно указанные сроки по всей России.

Мы осуществляем техническую поддержку нашим клиентам и предпродажную проверку качества продукции. На все поставляемые продукты мы предоставляем гарантию .

Осуществляем поставки продукции под контролем ВП МО РФ на предприятия военно-промышленного комплекса России , а также работаем в рамках 275 ФЗ с открытием отдельных счетов в уполномоченном банке. Система менеджмента качества компании соответствует требованиям ГОСТ ISO 9001.

Минимальные сроки поставки, гибкие цены, неограниченный ассортимент и индивидуальный подход к клиентам являются основой для выстраивания долгосрочного и эффективного сотрудничества с предприятиями радиоэлектронной промышленности, предприятиями ВПК и научно-исследовательскими институтами России.

С нами вы становитесь еще успешнее!

Наши контакты:

Телефон: +7 812 627 14 35

Электронная почта: sales@st-electron.ru

Адрес: 198099, Санкт-Петербург,
Промышленная ул, дом № 19, литера Н,
помещение 100-Н Офис 331