

Analog Devices Welcomes Hittite Microwave Corporation

NO CONTENT ON THE ATTACHED DOCUMENT HAS CHANGED



THIS PAGE INTENTIONALLY LEFT BLANK



HMC1056LP4BE

GaAs MMIC I/Q Mixer 8 - 12 GHz

Typical Applications

The HMC1056LP4BE is ideal for:

- Point-to-Point and Point-to-Multi-Point Radio
- Military Radar, EW & ELINT
- Satellite Communications
- Sensors

Features

- Wide IF Bandwidth: DC - 4 GHz
- Image Rejection: 25 dBc
- LO to RF isolation: 40 dB
- High Input IP3: 18 dBm
- 20 Lead 4x4 mm SMT Package: 16 mm²

Functional Diagram

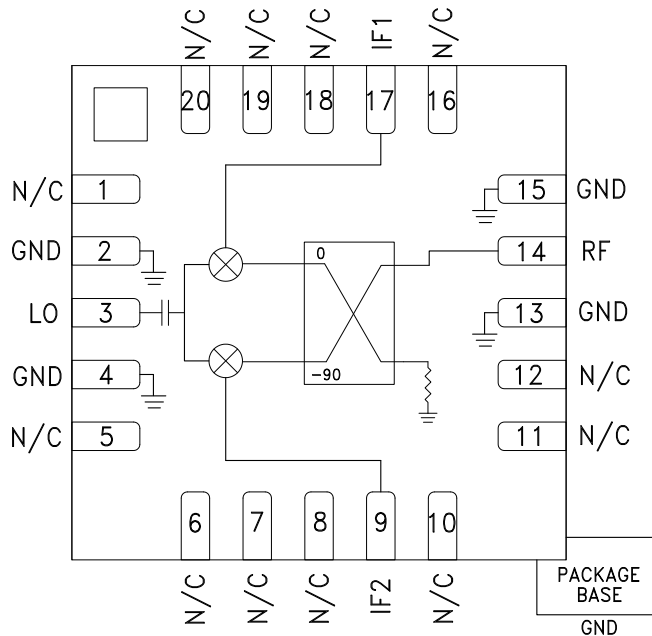

General Description

The HMC1056LP4BE is a compact I/Q MMIC mixer in a leadless "Pb free" SMT package, which can be used as either an Image Reject Mixer or a Single Sideband Upconverter. The mixer utilizes two standard Hittite double balanced mixer cells and a 90 degree hybrid fabricated in a GaAs Schottky diode process. A low frequency quadrature hybrid was used to produce a 100MHz LSB IF output. This product is a much smaller alternative to hybrid style Image Reject Mixers and Single Sideband Upconverter assemblies. The HMC1056LP4BE eliminates the need for wire bonding and allows the use of surface mount manufacturing techniques.

Electrical Specifications, $T_A = +25^\circ\text{C}$, IF = 100 MHz, LSB, LO = +10 dBm [1]

Parameter	Min.	Typ.	Max.	Min.	Typ.	Max.	Units
Frequency Range, RF/LO		8 - 10			10 - 12		GHz
Frequency Range, IF		DC - 4			DC - 4		GHz
Conversion Loss		8	11		8	11	dB
Image Rejection	18	25		12	18		dBc
LO to RF isolation	33	40		33	40		dB
LO to IF isolation		35			40		dB
IP3 (input)		18			17		dBm
Amplitude Balance [2]		+0.5			+1.5		dB
Phase Balance [2]		+2.5			-2.5		Deg

[1] Unless otherwise noted all measurements performed as downconverter.

[2] Data taken without external 90° hybrid.



Data Taken as SSB Downconverter with External IF 90° Hybrid, IF = 100 MHz

Conversion Gain, LSB vs. Temperature

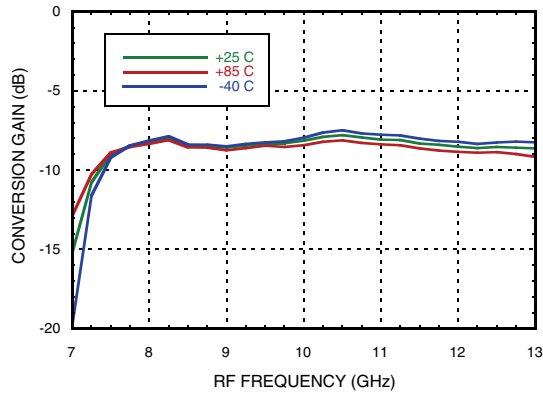

Conversion Gain, LSB vs. LO Drive

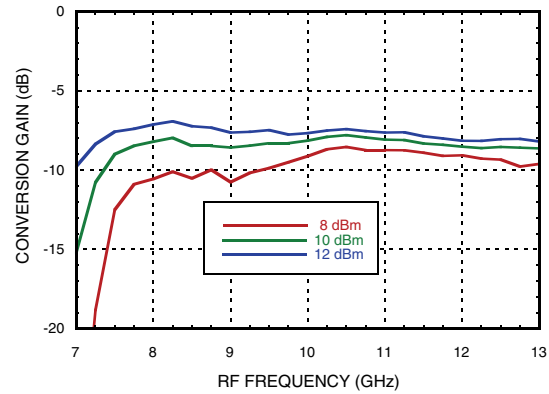

Image Rejection, LSB vs. Temperature

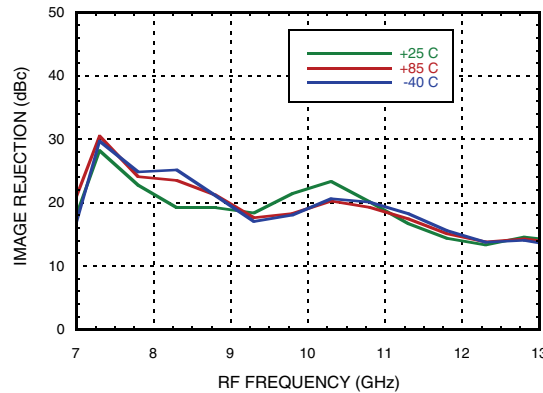
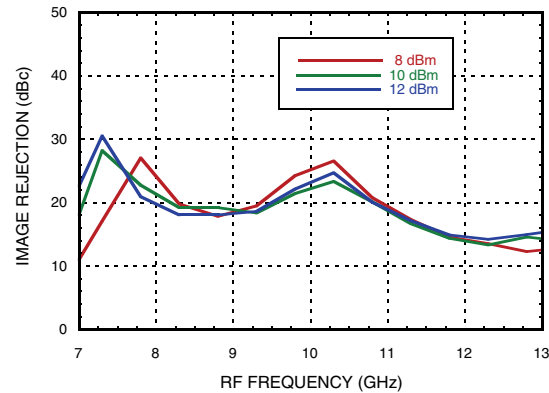
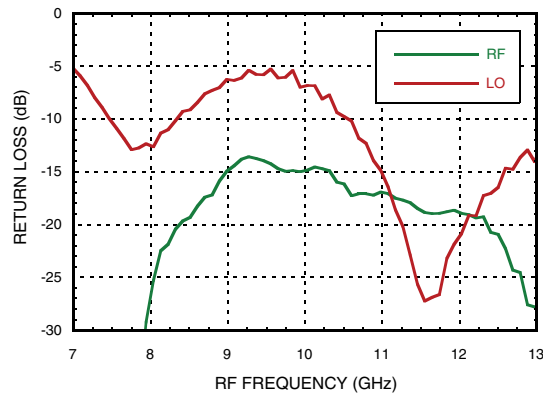

Image Rejection, LSB vs. LO Drive



Return Loss



Input P1dB, LSB vs. Temperature

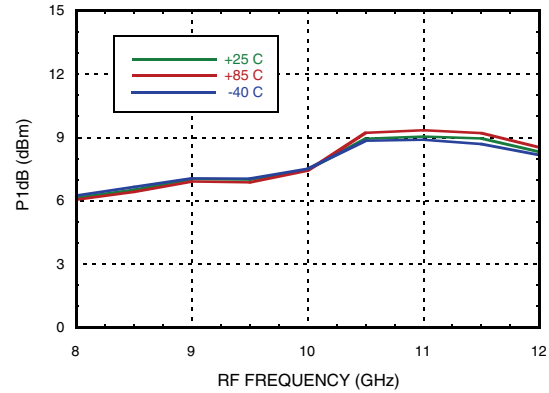

[1] Data taken without external IF 90° hybrid



Data Taken as SSB Downconverter with External IF 90° Hybrid, IF = 100 MHz

Input IP3, LSB vs. Temperature

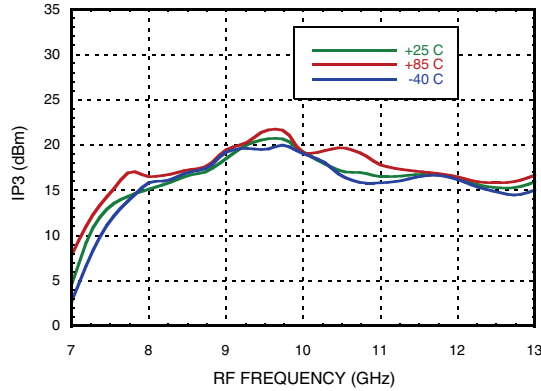

Input IP3, LSB vs. LO Drive

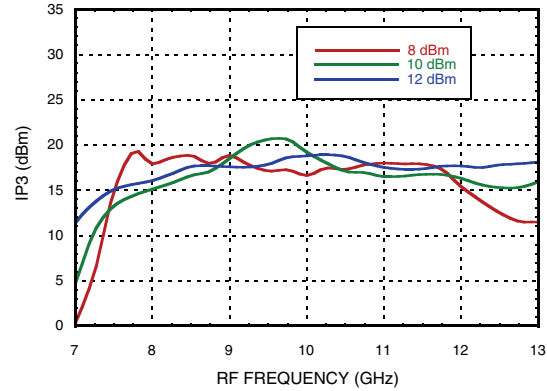

Isolations

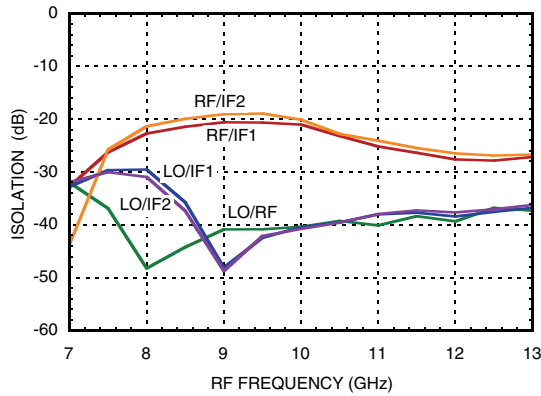

IF Bandwidth*

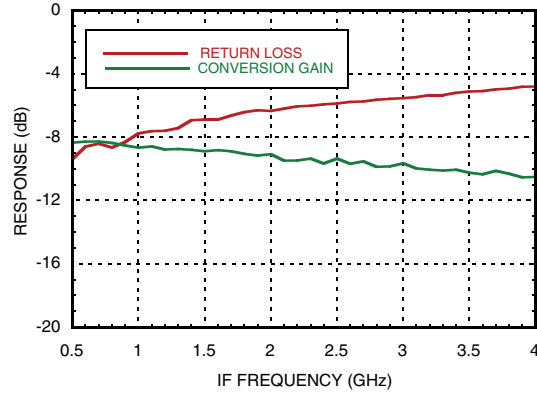

Amplitude Balance, LSB vs. LO Drive

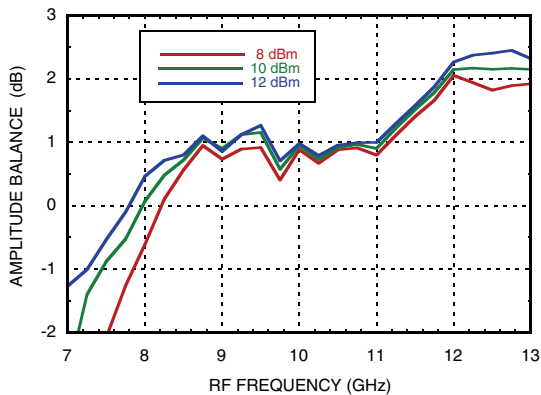

Phase Balance, LSB vs. LO Drive

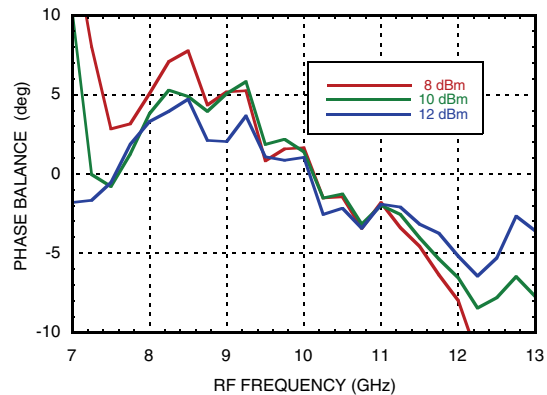

* Conversion gain data taken with external IF hybrid.



Data Taken as SSB Downconverter with External IF 90° Hybrid, IF = 100 MHz

Upconverter Performance, Conversion Gain, LSB vs. LO Drive

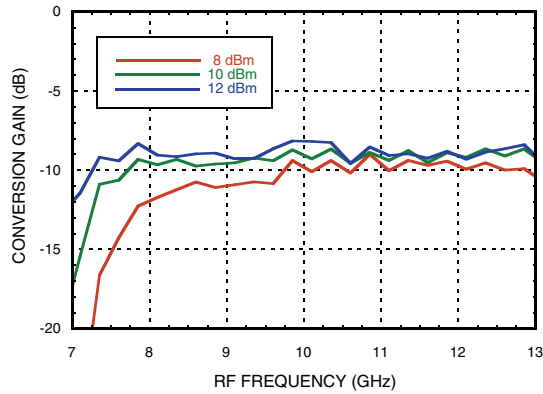

Upconverter Performance, Sideband Rejection, LSB vs. LO Drive,

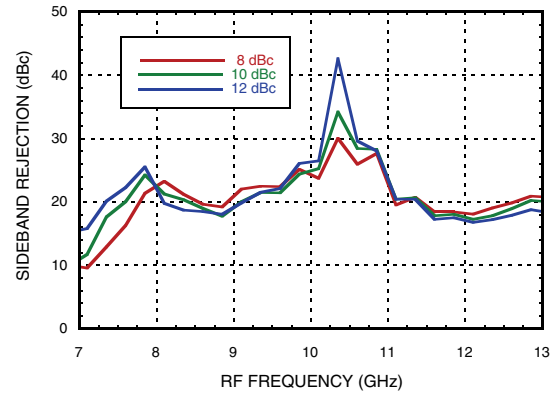

Conversion Gain, USB vs. Temperature

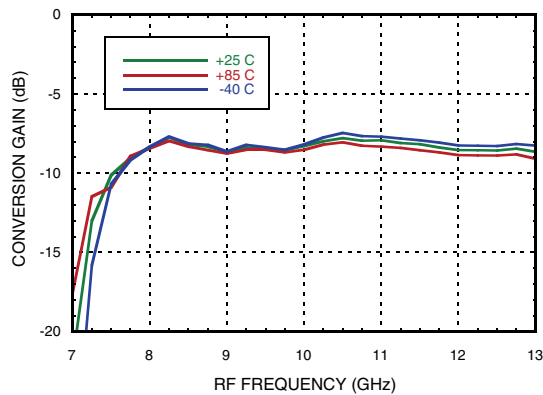

Conversion Gain, USB vs. LO Drive

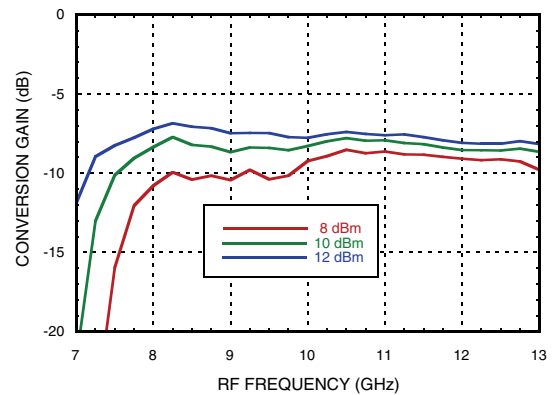

Image Rejection, USB vs. Temperature

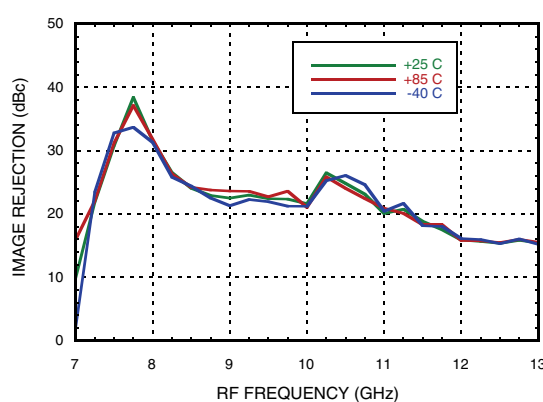
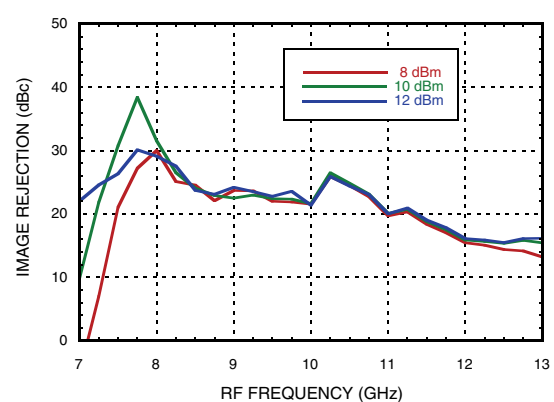

Image Rejection, USB vs. LO Drive





Data Taken as SSB Downconverter with External IF 90° Hybrid, IF = 100 MHz

Input P1dB, USB vs. Temperature

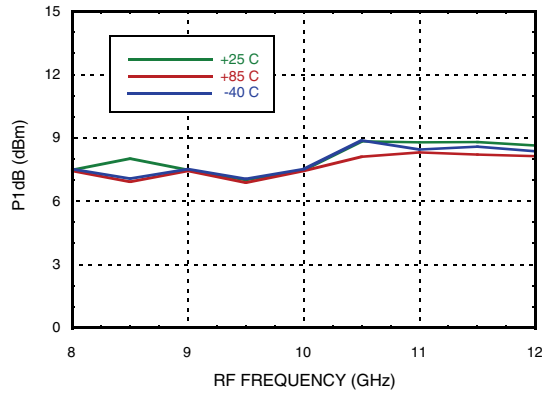

Input IP3, USB vs. Temperature

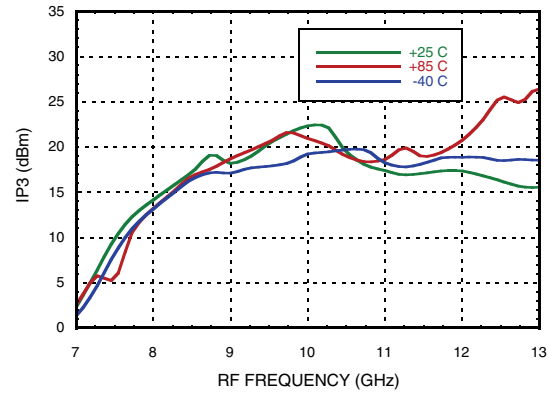

Input IP3, USB vs. LO Drive

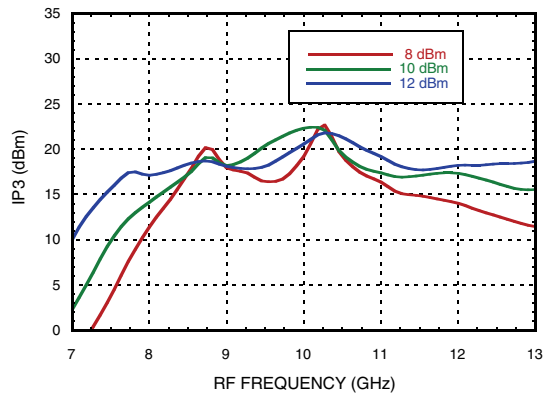

Amplitude Balance, USB vs. LO Drive

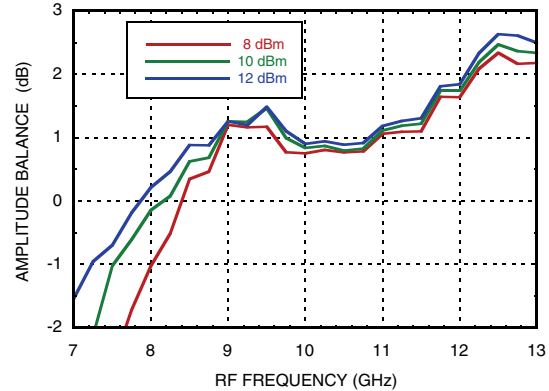

Phase Balance, USB vs. LO Drive

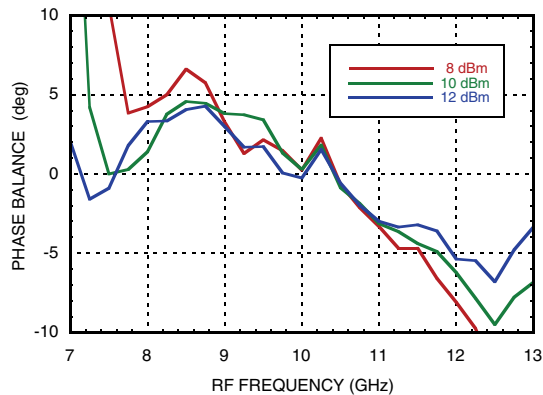

Upconverter Performance, Conversion Gain, USB vs. LO Drive

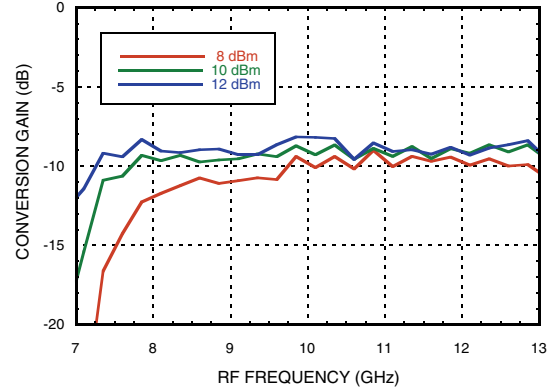



Data Taken as SSB Upconverter with External IF 90° Hybrid, IF = 100 MHz

**Upconverter Performance, Sideband
Rejection, USB vs. LO Drive,**

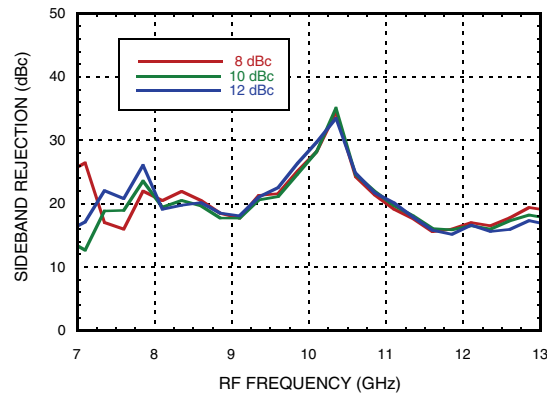



Data Taken as SSB Downconverter with External IF 90° Hybrid, IF = 1000 MHz

Conversion Gain, LSB vs. Temperature

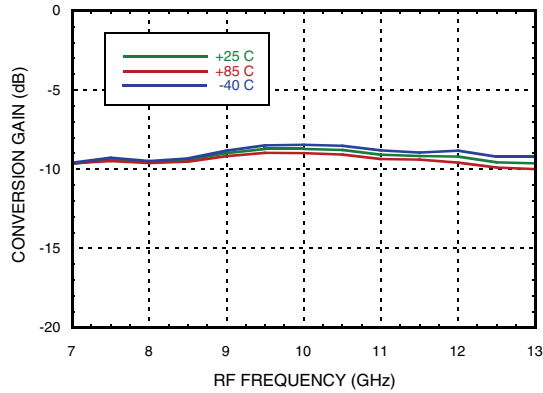

Conversion Gain, LSB vs. LO Drive

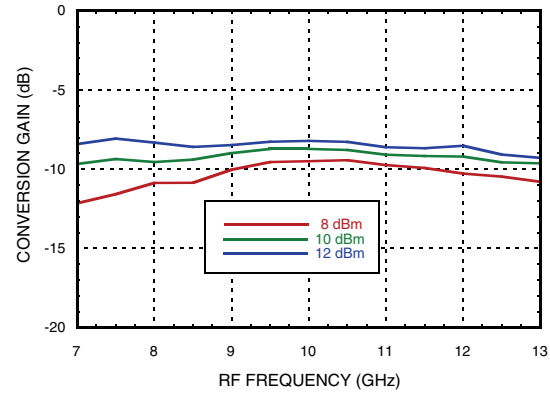

Image Rejection, LSB vs. Temperature

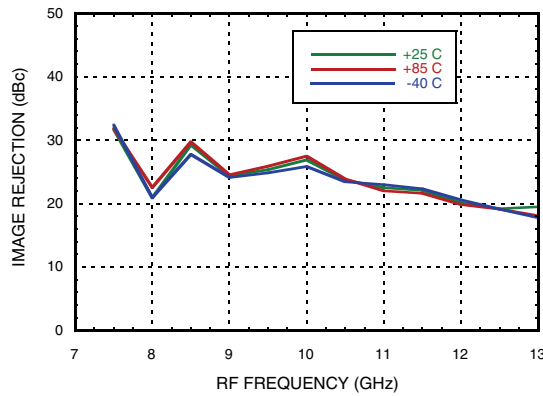
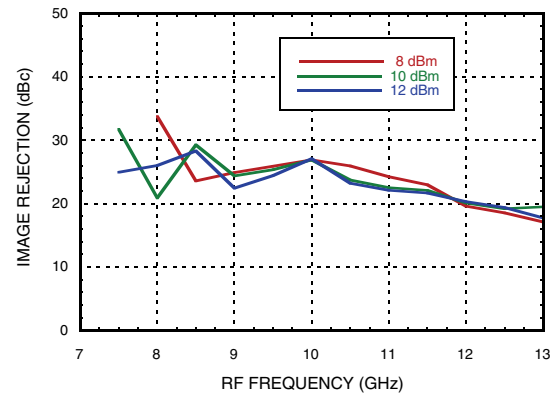
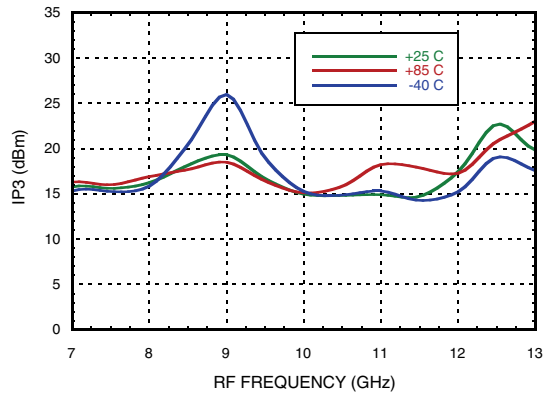

Image Rejection, LSB vs. LO Drive



Input IP3, LSB vs. Temperature



Input IP3, LSB vs. LO Drive

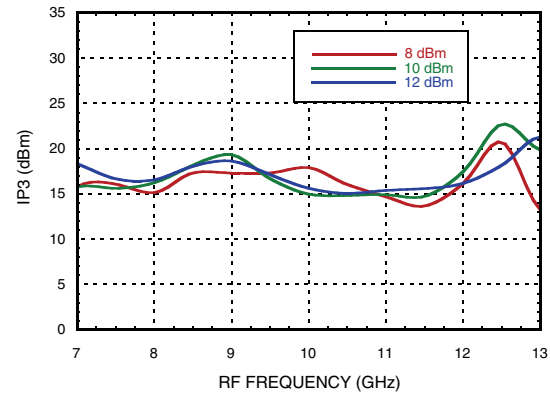



Data Taken as SSB Downconverter with External IF 90° Hybrid, IF = 1000 MHz

Upconverter Performance, Conversion Gain, LSB vs. LO Drive

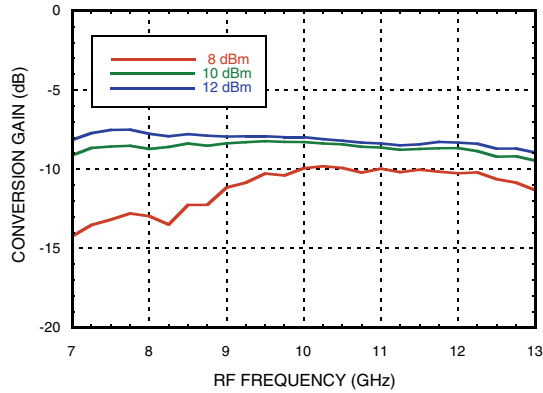

Upconverter Performance, Sideband Rejection, LSB vs. LO Drive,

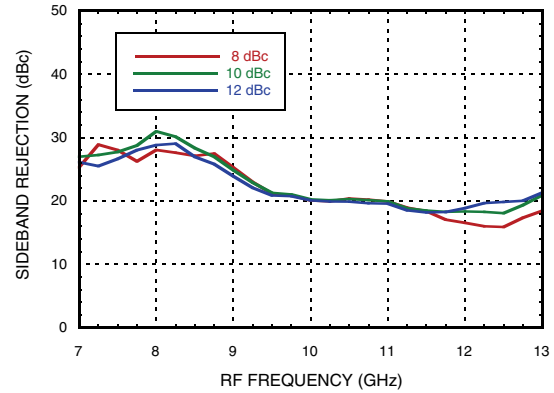

Conversion Gain, USB vs. Temperature

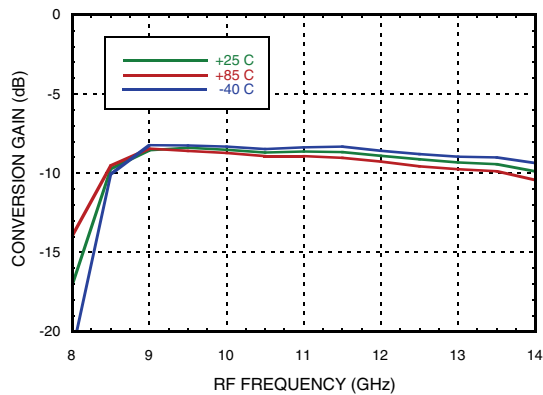

Conversion Gain, USB vs. LO Drive

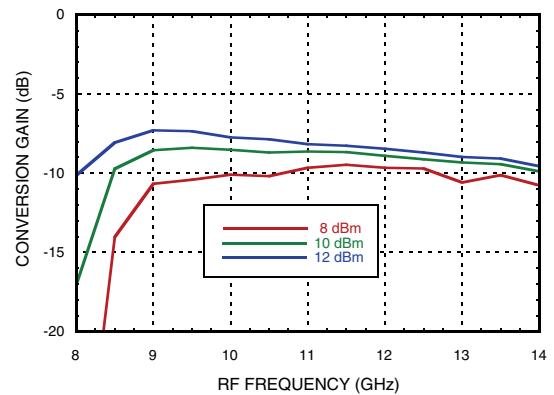

Image Rejection, USB vs. Temperature

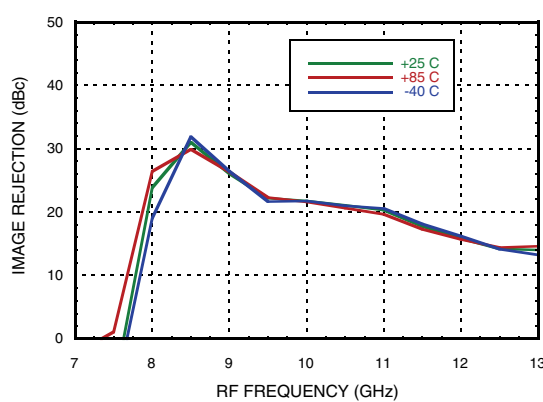
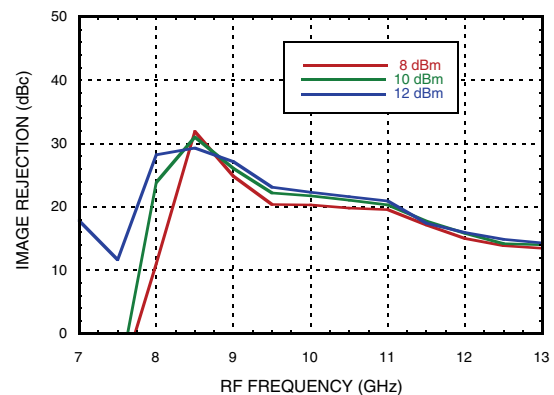

Image Rejection, USB vs. LO Drive





Data Taken as SSB Downconverter with External IF 90° Hybrid, IF = 1000 MHz

Input IP3, USB vs. Temperature

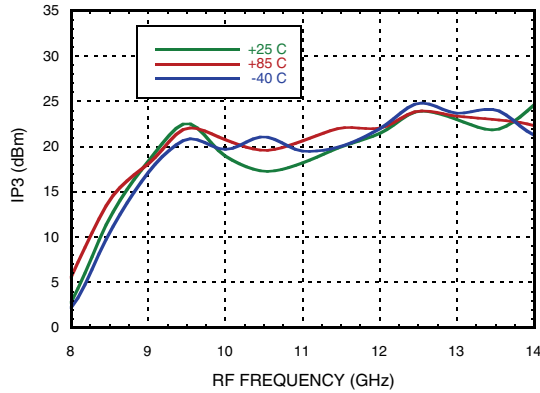

Input IP3, USB vs. LO Drive

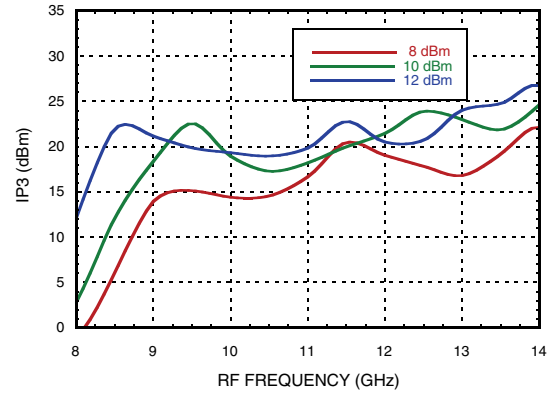

Upconverter Performance, Conversion Gain, USB vs. LO Drive

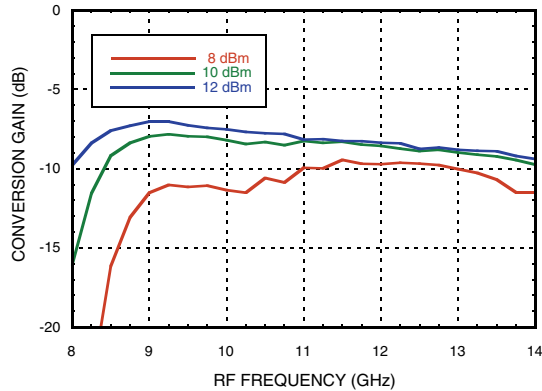

Upconverter Performance, Sideband Rejection, USB vs. LO Drive

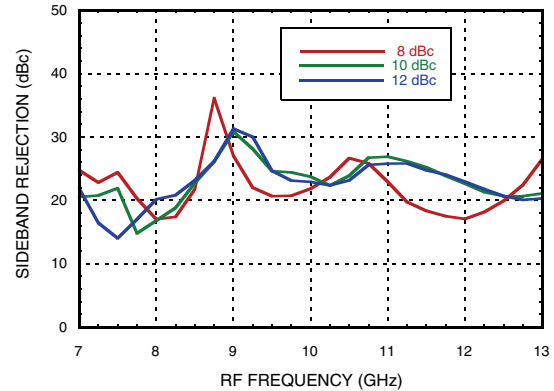

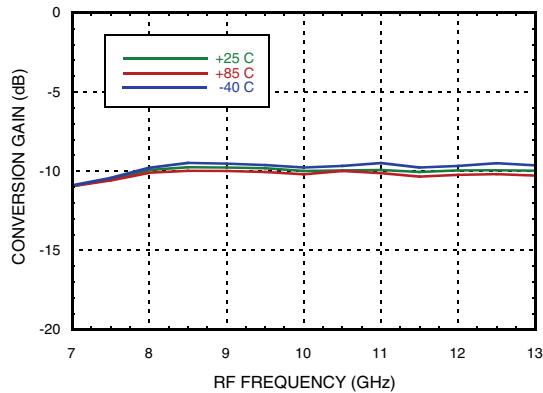
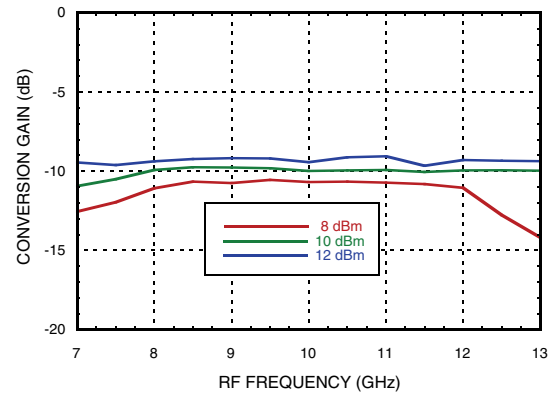
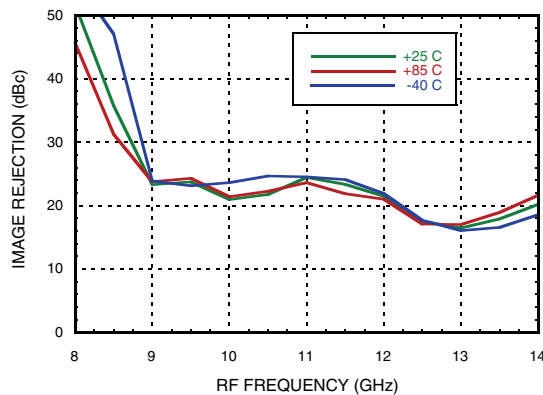
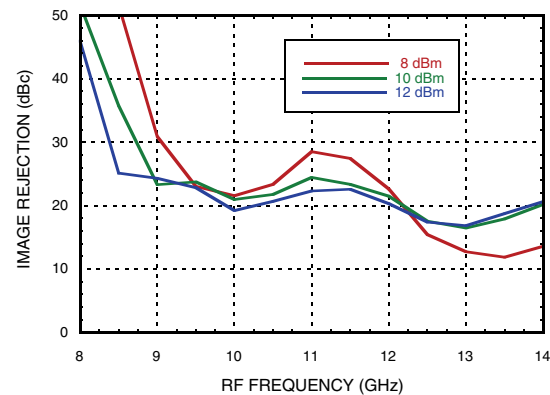
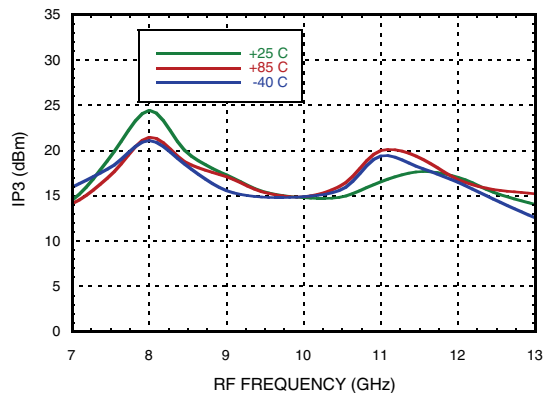
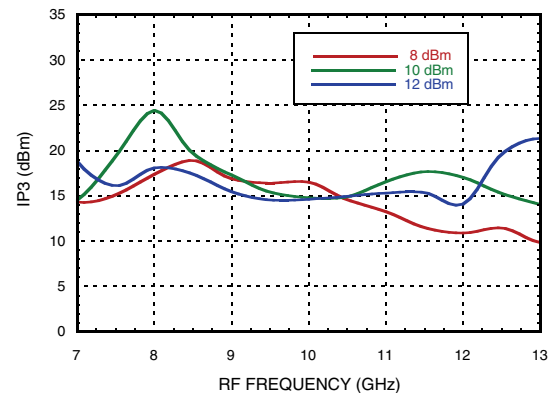

Data Taken as SSB Downconverter with External IF 90° Hybrid, IF = 2000 MHz
Conversion Gain, LSB vs. Temperature

Conversion Gain, LSB vs. LO Drive

Image Rejection, LSB vs. Temperature

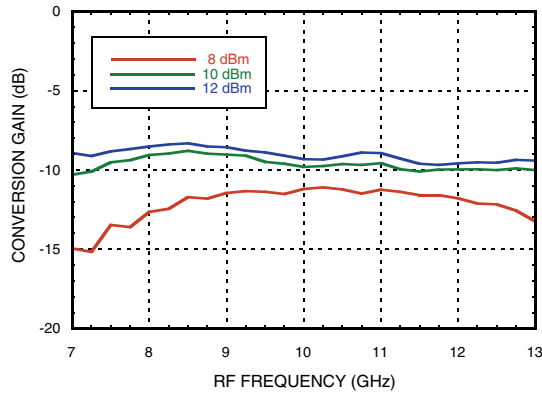
Image Rejection, LSB vs. LO Drive

Input IP3, LSB vs. Temperature

Input IP3, LSB vs. LO Drive



Data Taken as SSB Downconverter with External IF 90° Hybrid, IF = 2000 MHz

Upconverter Performance, Conversion Gain, LSB vs. LO Drive



Upconverter Performance, Sideband Rejection, LSB vs. LO Drive,

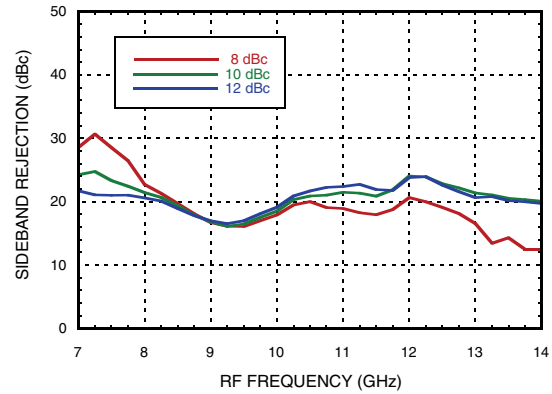

Conversion Gain, USB vs. Temperature

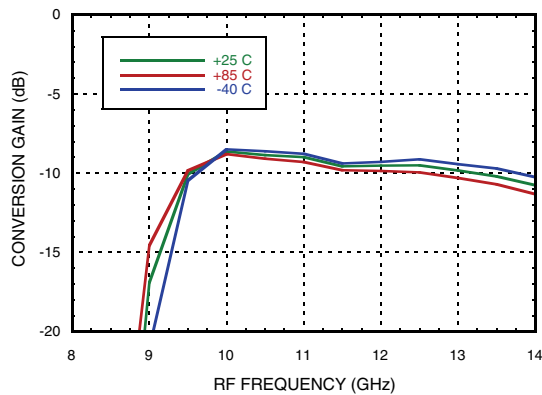

Conversion Gain, USB vs. LO Drive

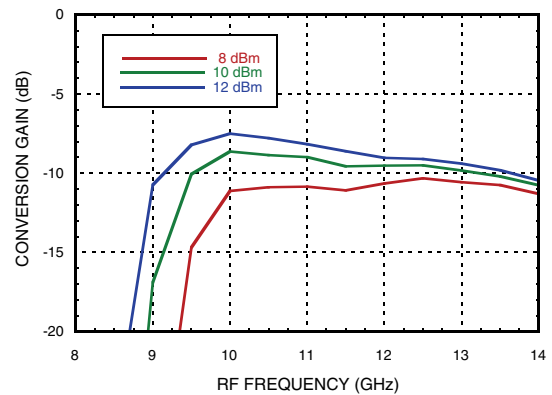

Image Rejection, USB vs. Temperature

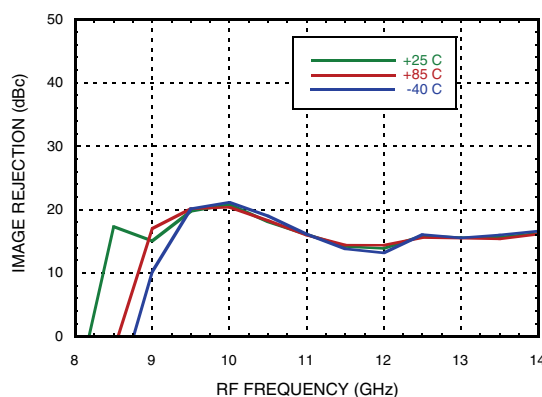
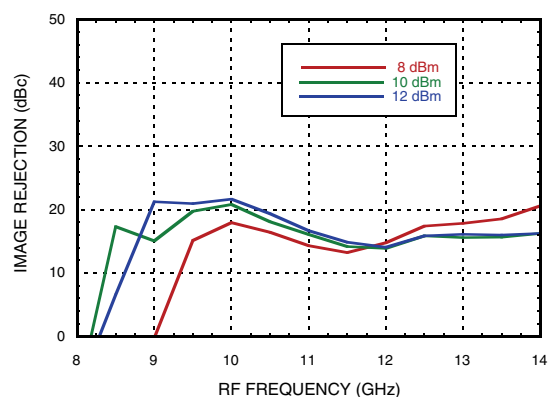
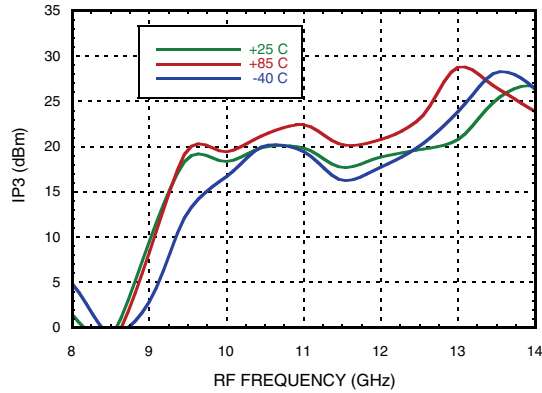

Image Rejection, USB vs. LO Drive





Input IP3, USB vs. Temperature



Input IP3, USB vs. LO Drive

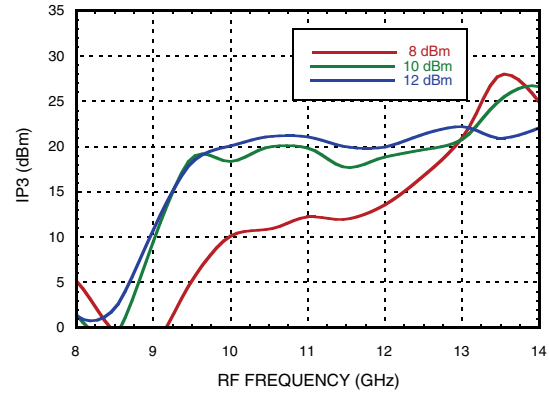

Upconverter Performance, Conversion Gain, USB vs. LO Drive

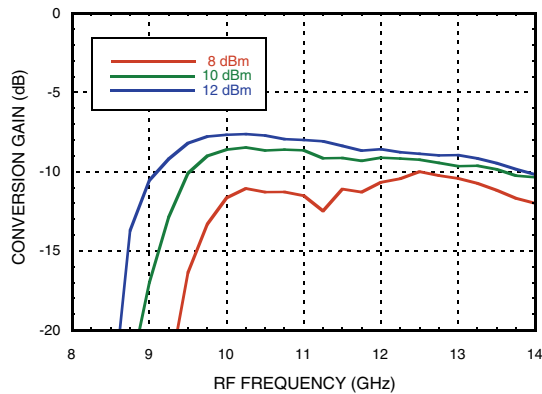

Upconverter Performance, Sideband Rejection, USB vs. LO Drive,

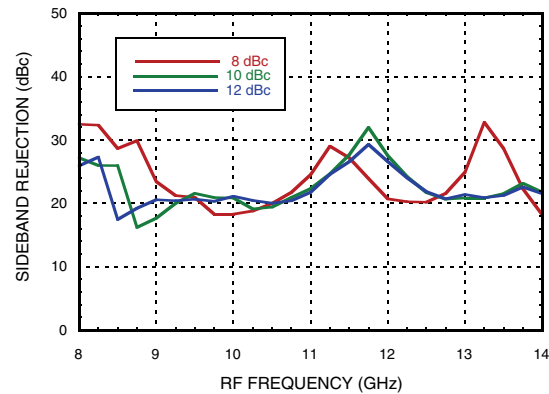

Harmonics of LO

LO Freq. (GHz)	nLO Spur at RF Port			
	1	2	3	4
7	41.3	37.6	74.4	74.2
8	36.3	36.3	52	82.1
9	37.2	52.9	63.6	81.4
10	36.8	56.4	65.5	100.4
11	37.3	59.8	68.9	68.8
12	37.4	56.2	65.3	78.9
13	38.1	56.4	69.6	x

LO = + 10 dBm
Values in dBc below LO level measured at RF Port.

MxN Spurious Outputs

mRF	nLO				
	0	1	2	3	4
0	xx	8	38	48	60
1	8	0	28	43	60
2	64	50	56	48	67
3	94	78	67	64	78
4	x	x	x	x	x

RF = 10 GHz @ -10 dBm
LO = 10.1 GHz @ +10 dBm
Data taken without IF hybrid
All values in dBc below IF power level

Absolute Maximum Ratings

IF Input (At LO = 10 dBm and RF = -10 dBm)	+15.5 dBm
RF Input (At 10 dBm LO power)	+16 dBm
LO Input (At -10 dBm RF power)	+17 dBm
Channel Temperature	175 °C
Continuous Pdiss (T = 85°C) (derate 8.9 mW/°C above 85°C)	800 mW
Thermal Resistance (channel to ground paddle)	112 °C/W
Storage Temperature	-65 to +150 °C
Operating Temperature	-40 to +85 °C
ESD Sensitivity (HBM)	Class 0, Passed 150V



ELECTROSTATIC SENSITIVE DEVICE
OBSERVE HANDLING PRECAUTIONS

Outline Drawing

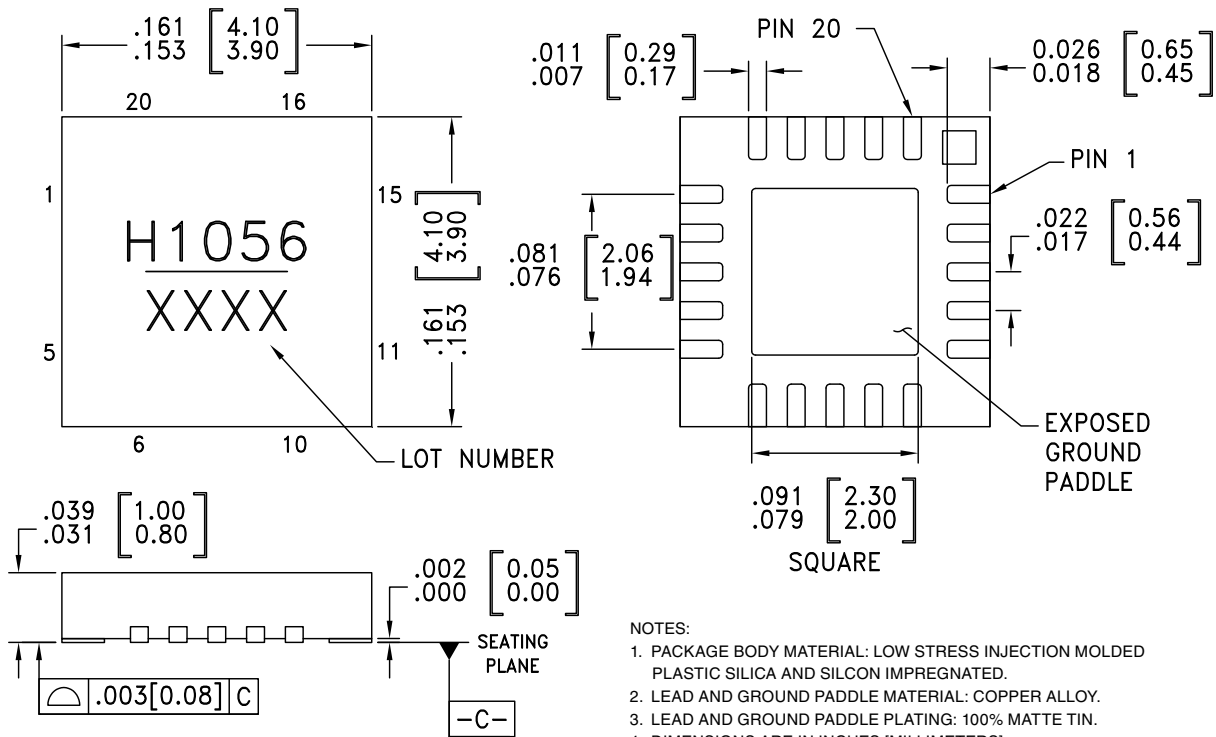

NOTES:

1. PACKAGE BODY MATERIAL: LOW STRESS INJECTION MOLDED PLASTIC SILICA AND SILICON IMPREGNATED.
2. LEAD AND GROUND PADDLE MATERIAL: COPPER ALLOY.
3. LEAD AND GROUND PADDLE PLATING: 100% MATTE TIN.
4. DIMENSIONS ARE IN INCHES [MILLIMETERS].
5. LEAD SPACING TOLERANCE IS NON-CUMULATIVE.
6. PAD BURR LENGTH SHALL BE 0.15mm MAX. PAD BURR HEIGHT SHALL BE 0.05mm MAX.
7. PACKAGE WARP SHALL NOT EXCEED 0.05mm.
8. ALL GROUND LEADS AND GROUND PADDLE MUST BE SOLDERED TO PCB RF GROUND.



Package Information

Part Number	Package Body Material	Lead Finish	MSL Rating [2]	Package Marking [1]
HMC1056LP4BE	RoHS-compliant Low Stress Injection Molded Plastic	100% matte Sn	MSL1	H1056 XXXX

[1] 4-Digit lot number XXXX

[2] Max peak reflow temperature of 260 °C

Pin Descriptions

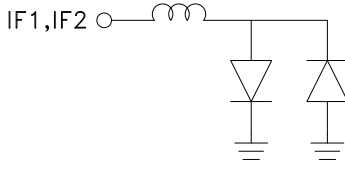
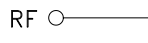
Pin Number	Function	Description	Interface Schematic
1, 5-8, 10-12, 16, 18-20	N/C	These pins are not connected internally; however, all data shown herein was measured with these pins connected to RF/DC ground externally.	
2, 4, 13, 15	GND	These pins and the exposed ground paddle must be connected to RF/DC ground.	
3	LO	This pin is AC coupled and matched to 50 Ohms .	
9	IF2	Differential IF input pins. For applications not requiring operation to DC, an off chip DC blocking capacitor should be used. For operation to DC this pin must not source/sink more than 3mA of current or part non function and possible part failure will result.	
17	IF1		
14	RF	This pin is matched to 50 Ohms.	

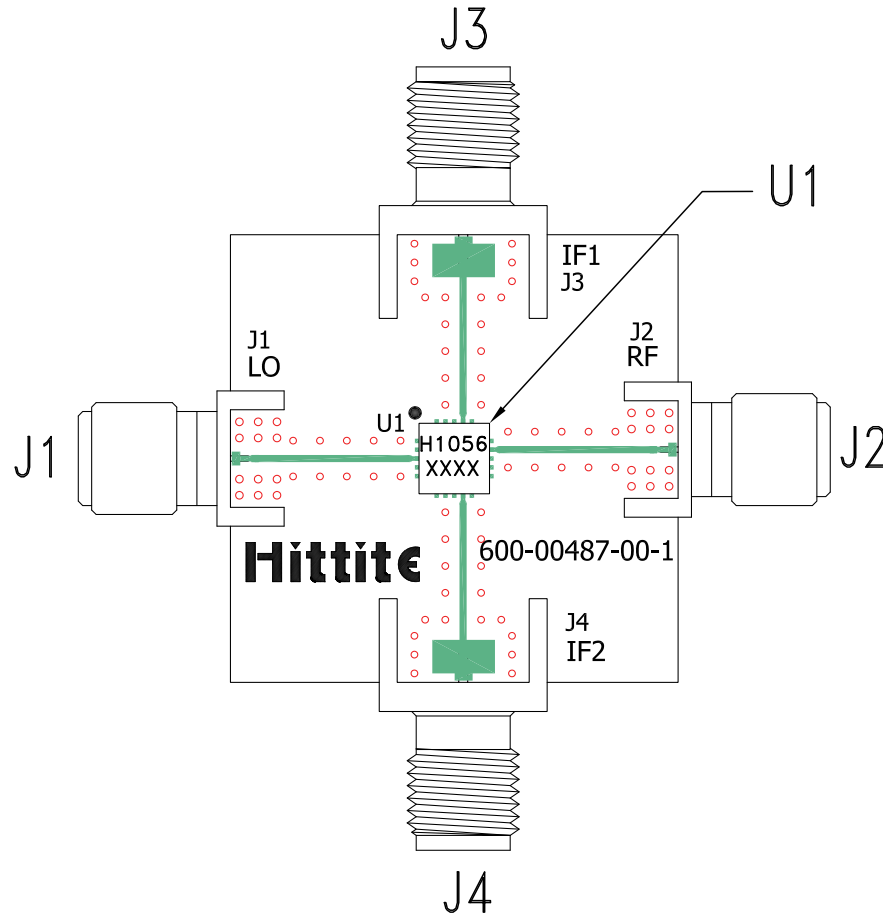
Evaluation PCB

List of Materials for Evaluation PCB EVAL01-HMC1056LP4B^[1]

Item	Description
J1, J2	PCB Mount SMA RF Connector, SRI
J3 - J4	PCB Mount SMA Connector, Johnson
U1	HMC1056LP4BE
PCB [2]	600-00487-00-1 Evaluation Board

[1] Reference this number when ordering complete evaluation PCB

[2] Circuit Board Material: Rogers 4350

The circuit board used in the application should use RF circuit design techniques. Signal lines should have 50 Ohm impedance while the package ground leads and exposed paddle should be connected directly to the ground plane similar to that shown. A sufficient number of via holes should be used to connect the top and bottom ground planes. The evaluation circuit board shown is available from Hittite upon request.



HMC1056LP4BE

GaAs MMIC I/Q Mixer
8 - 12 GHz

Notes:



Стандарт Электрон Связь

Мы молодая и активно развивающаяся компания в области поставок электронных компонентов. Мы поставляем электронные компоненты отечественного и импортного производства напрямую от производителей и с крупнейших складов мира.

Благодаря сотрудничеству с мировыми поставщиками мы осуществляем комплексные и плановые поставки широчайшего спектра электронных компонентов.

Собственная эффективная логистика и склад в обеспечивает надежную поставку продукции в точно указанные сроки по всей России.

Мы осуществляем техническую поддержку нашим клиентам и предпродажную проверку качества продукции. На все поставляемые продукты мы предоставляем гарантию .

Осуществляем поставки продукции под контролем ВП МО РФ на предприятия военно-промышленного комплекса России , а также работаем в рамках 275 ФЗ с открытием отдельных счетов в уполномоченном банке. Система менеджмента качества компании соответствует требованиям ГОСТ ISO 9001.

Минимальные сроки поставки, гибкие цены, неограниченный ассортимент и индивидуальный подход к клиентам являются основой для выстраивания долгосрочного и эффективного сотрудничества с предприятиями радиоэлектронной промышленности, предприятиями ВПК и научно-исследовательскими институтами России.

С нами вы становитесь еще успешнее!

Наши контакты:

Телефон: +7 812 627 14 35

Электронная почта: sales@st-electron.ru

Адрес: 198099, Санкт-Петербург,
Промышленная ул, дом № 19, литера Н,
помещение 100-Н Офис 331