

# CBT-120

## Monolithic Die Series

### Ultraviolet Chip On Board LEDs

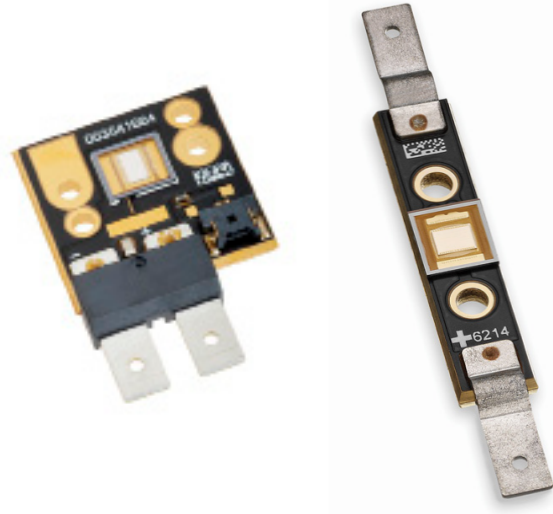

#### Table of Contents

- Technology Overview .....2
- Ordering Information .....3
- Binning Structure .....4
- Optical & Electrical Characteristics .....5
- Optical & Electrical Characteristics Graphs. ....6
- Typical Spectrum .....7
- Reliability.....8
- Thermal Resistance .....9
- Mechanical Dimensions Slim Package (C14) ..... 10
- Mechanical Dimensions Square Package (C31) .... 11
- Shipping Tray Slim Package (C14) ..... 12
- Shipping Tray Square Package (C31) ..... 13
- Packaging Specifications . 14

#### Features:

- High thermal conductivity package .
  - › Junction to heat sink thermal resistance of < 1 °C/W
- UV LED technology for very high power density and uniform emission
- Large, monolithic chip with surface emitting area of 12 mm<sup>2</sup>, 16:9 aspect ratio
- Low-profile window for efficient coupling into small-étendue systems
- High radiometric efficiency
- Environmentally friendly: RoHS compliant, mercury-free
- Variable drive currents: less than 1 A through 30 A
- NIST traceable optical and electrical measurement testing

#### Applications

- Curing:
  - › Inks
  - › Coatings
  - › Adhesives
- Inspection
- Machine Vision
- Fiber-coupled illumination
- Specialty Projection Systems for Maskless Lithography:
  - › Optically matched to TI 0.65” and 0.95” DMD chipsets
- Rapid Prototyping and 3D printing
- Medical and Scientific Instrumentation

## Technology Overview

Luminus LEDs benefit from innovations in device technology, chip packaging and thermal management. This suite of technologies give engineers and system designers the freedom to develop solutions both high in power and efficiency.

### Luminus Technology

Luminus' technology enables large area LED chips to emit photons uniformly over the entire LED chip surface. The intense optical power density produced by these UV LEDs facilitate designs which replace arc and halogen lamps where arrays of traditional high power LEDs cannot.

For UV devices, Luminus engineers the LEDs to maximize light extraction and to emit with a Lambertian far-field distribution pattern. The design maximizes efficiency and allows for flexible optical designs.

### Packaging Technology

Thermal management is critical in high power LED applications. Luminus CBT-120-UV LEDs have the lowest thermal resistance of any LED on the market with a thermal resistance from junction to heat sink of 0.73°C/W or 0.88°C/W. This allows the LED to be driven at higher current densities while maintaining a low junction temperature, thereby resulting in brighter solutions and longer lifetimes.

### Reliability

Designed from the ground up, Luminus LEDs are one of the most reliable light sources in the world today. Luminus LEDs have passed a rigorous suite of environmental and mechanical stress tests, including mechanical shock, vibration, temperature cycling and humidity, and have been fully qualified for use in extreme high power and high current applications. With very low failure rates and median lifetimes that typically exceed 10,000 hours, Luminus LEDs are ready for even the most demanding applications.

### Environmental Benefits

Luminus LEDs help reduce power consumption and the amount of hazardous waste entering the environment. All LED products manufactured by Luminus are RoHS compliant and free of hazardous materials, including lead and mercury.

## Understanding Big Chip LED Test Specifications

Every Luminus LED is fully tested to ensure that it meets the high quality standards expected from Luminus' products.

### Testing Temperature

Luminus core board products are typically measured in such a way that the characteristics reported agree with how the devices will actually perform when incorporated into a system. This measurement is accomplished by mounting the devices on a 40°C heat sink and measuring the device while fully powered. This method of measurement ensures that Luminus LEDs perform in the field just as they are specified.

### Multiple Operating Points

The tables on the following pages provide typical optical and electrical characteristics for the standard drive conditions. Since the LEDs can be operated over a wide range of drive conditions (currents from <1A to 30 A, and duty cycle from <1% to 100%) there are many other potential values attainable. Driving devices beyond recommended driving conditions shortens lifetime (see derating curves on page 6).

## Ordering Information

### Part Number Nomenclature

CBT — 120 — CC — C## — FF###-2#

Product Family	Chip Area	Color	Package Configuration	Bin Kit <sup>1,2,3</sup>
CBT: Copper-core PCB, Monolithic Die	120: 12 mm <sup>2</sup>	UV = Ultraviolet	C14: 44.5 mm x 10 mm - Slim Package C31: 28 mm x 26.75 mm - Square Package See Mechanical Drawing section	See below for bin definition table

Note 1: A Bin Kit represents a group of individual flux or power bins that are shippable for a given ordering part number. Individual flux bins are not orderable.

Note 2: Flux Bin listed is minimum bin shipped - higher bins may be included at Luminus' discretion

### CBT-120-UV Bin Kit Order Codes

The following tables describe the bin kit ordering codes for the CBT-120-UV. The power and wavelength bins included in the bin kit. Each kit specifies a minimum power and the listed wavelength. A maximum power is not specified. Within each kit, Luminus may ship any part meeting or exceeding the minimum power specification. Shipments will always meet the listed wavelength bin's range. For information on ordering bin kits not listed below, please contact Luminus or an official distributor.

Products	Ordering Part Number	Description
CBT-120-UV	CBT-120-UV-C31-x123-22	CBT-120-UV consisting of a 12 mm <sup>2</sup> LED, a thermistor, connectors, and a square copper-core PCB.
	CBT-120-UV-C14-x123-22	CBT-120-UV consisting of a 12 mm <sup>2</sup> LED, connectors, and a slim (rectangular) copper-core PCB.

Color	Bin Kit Code	Power (W)	Wavelength (nm)	
		Minimum Allowed	Min.	Max.
UV	P400-22	16.1	400	410
	Q400-22	17.7	400	410
	R400-22	19.5	400	410

### CBT-120-UV Binning Structure

CBT-120-UV LEDs are specified for luminous flux and chromaticity/wavelength at a drive current of 18 A (1.5 A/mm<sup>2</sup>) and placed into one of the following Power Bins and Wavelength Bins:

#### Power Bins

Color	Power Flux Bin (F)	Minimum Flux (W)	Maximum Flux (W)
UV	N	14.6	16.1
	P	16.1	17.7
	Q	17.7	19.5
	R	19.5	21.4
	S	21.4	23.6

\*Note: Luminus maintains a +/- 6% tolerance on power measurements.

#### Wavelength Bins

Color	Wavelength Bin (123)	Minimum Wavelength (nm)	Maximum Wavelength (nm)
UV	395	395	400
	400	400	405
	405	405	410
	410	410	415

**Reference Optical & Electrical Characteristics ( $T_{hs} = 40^{\circ}\text{C}$ )<sup>1,2</sup>**

UV			
Parameter	Symbol	Values	Unit
Drive Condition <sup>3</sup>		18 A	
Current Density	$j$	1.5	A/mm <sup>2</sup>
Forward Voltage	$V_{Fmin}$	3.3	V
	$V_F$	3.4	V
	$V_{Fmax}$	5.9	V
Radiometric Flux <sup>5</sup>	$\Phi_{typ}$	18.0	W
Radiometric Flux Density	$\Phi_R$	1.5	W/mm <sup>2</sup>
Wavelength Range	$\lambda$	400 - 410	nm
Peak Wavelength	$\lambda_p$	405	nm

	Symbol	UV	Unit
Emitting Area		12.0	mm <sup>2</sup>
Emitting Area Dimensions		4.63 × 2.6	mm × mm
Dynamic Resistance	$\Omega_{dyn}$	0.02	$\Omega$

**Absolute Maximum Ratings**

	Symbol	UV	Unit
Maximum Current <sup>6</sup>		30	A
Maximum Junction Temperature <sup>7</sup>	$T_{jmax}$	150	$^{\circ}\text{C}$
Storage Temperature Range		-40 to +100	$^{\circ}\text{C}$

Note 1: Data verified using NIST traceable calibration standard.

Note 2: All data are based on test conditions with a constant heat sink temperature  $T_{hs} = 40^{\circ}\text{C}$  under pulse testing conditions. Pulse conditions: 25% duty-cycle and frequency of 360 Hz. Nominal  $T_j \approx 80^{\circ}\text{C}$ . See Thermal Resistance section for  $T_j$  and  $T_{hs}$  definition.

Note 3: Listed drive conditions are typical for common applications. CBT-120-UV devices can be driven at currents ranging from <1 A to 30 A and at duty cycles ranging from 1% to 100%. Drive current and duty cycle should be adjusted as necessary to maintain the junction temperature desired to meet application lifetime requirements.

Note 4: Unless otherwise noted, values listed are typical. Devices are production tested and specified at 18 A.

Note 5: Typical total flux from emitting area at listed peak wavelength. Reported performance is included to show trends for a selected power level. For specific minimum and maximum values, use bin tables. For product roadmap and future performance of devices, contact Luminus.

Note 6: CBT-120-UV LEDs are designed for operation to an absolute maximum current as specified above. Product lifetime data is specified at recommended forward drive currents. Sustained operation at or beyond absolute maximum currents will result in a reduction of device life time compared to recommended forward drive currents. Actual device lifetimes will also depend on junction temperature. Refer to the lifetime derating curves for further information. In pulsed operation, rise time from 10-90% of forward current should be longer than 0.5  $\mu\text{seconds}$ .

Note 7: Lifetime dependent on LED junction temperature. Input power and thermal system must be properly managed to ensure lifetime. See charts on page 5 for further information.

Note 8: Special design considerations must be observed for operation under 1 A. Please contact Luminus for further information.

## Optical & Electrical Characteristics

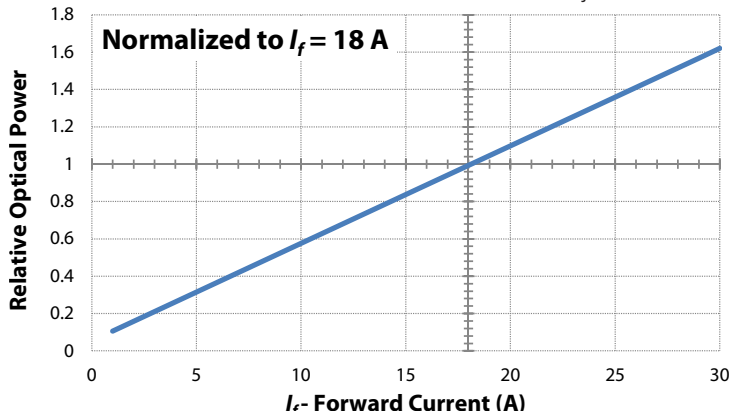
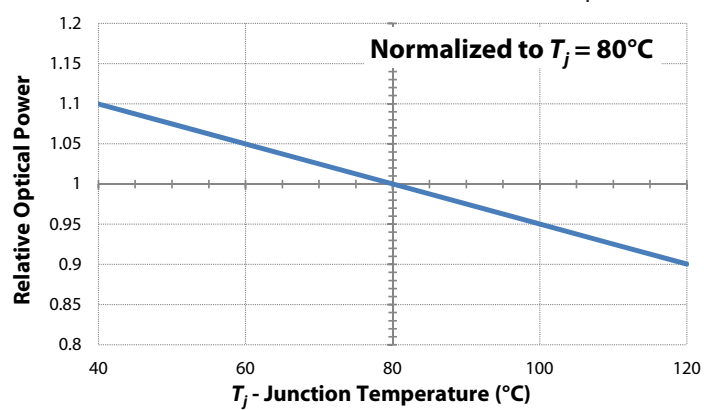
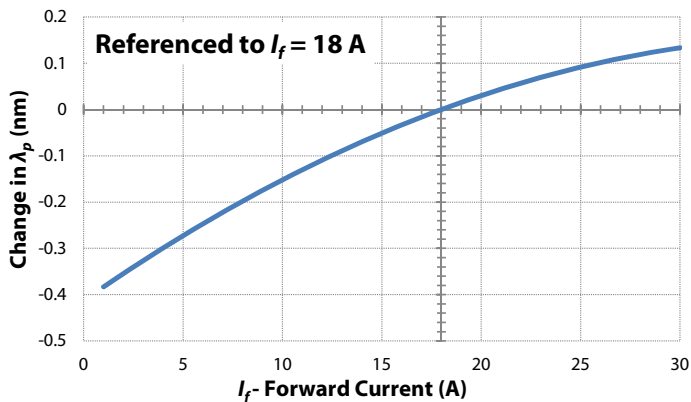
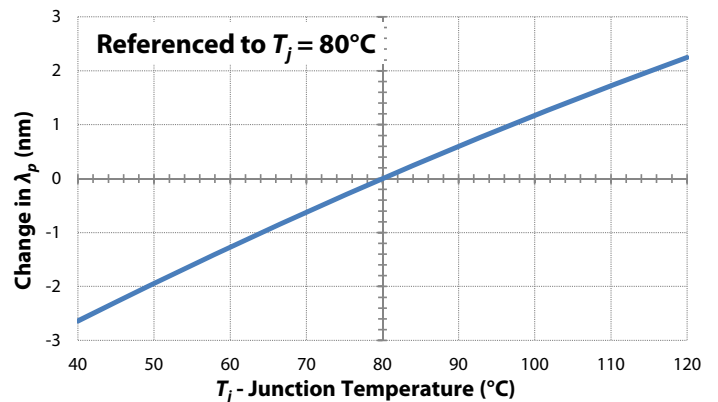
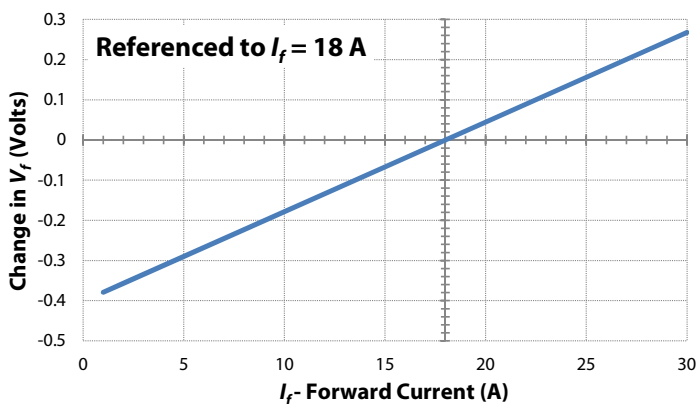
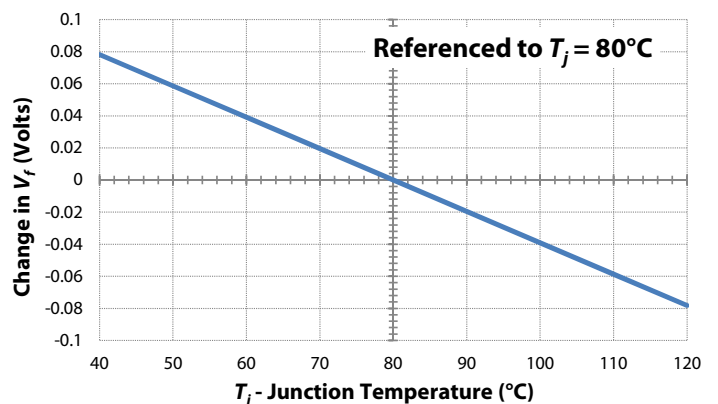
**Relative Power vs Forward Current,  $T_j = 120^\circ\text{C}$** 

**Relative Power vs Junc. Temperature,  $I_f = 18\text{ A}$** 

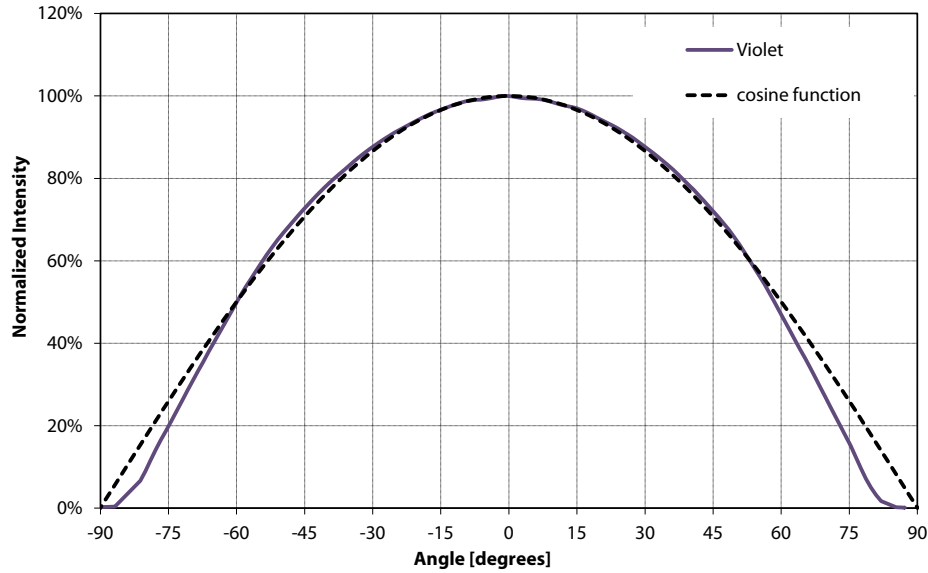
**Peak Wavelength vs Forward Current**

**Peak Wavelength vs Junction Temperature**

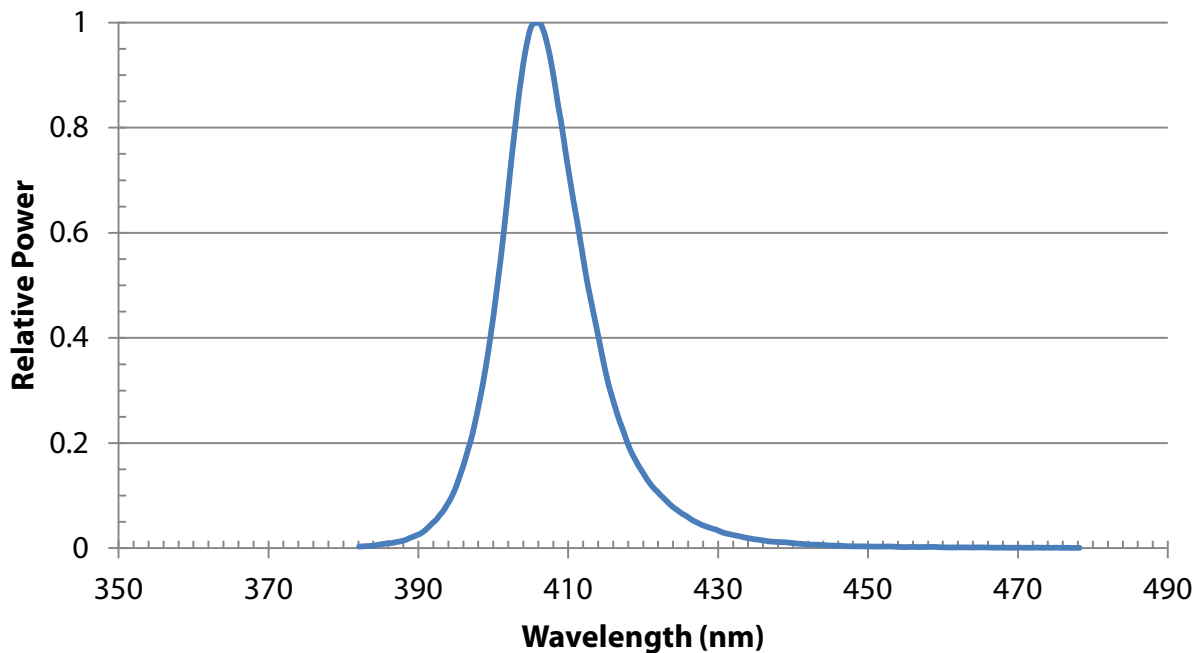
**Forward Voltage vs Forward Current**

**Forward Voltage vs Junction Temperature**

### Typical Radiation Pattern



### Typical Spectrum<sup>9</sup>

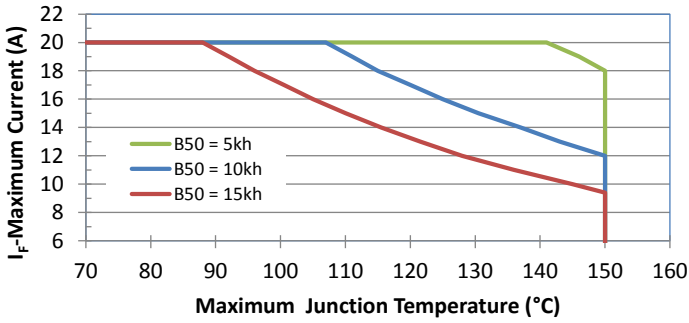
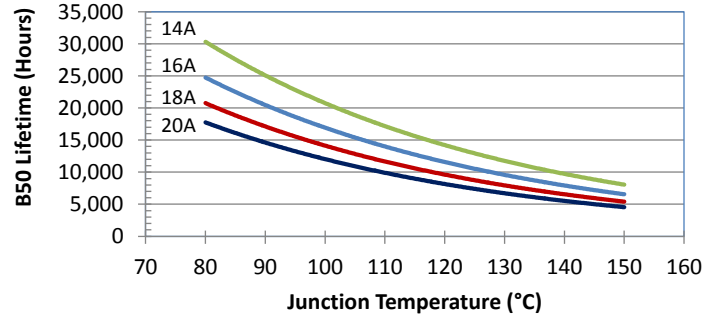
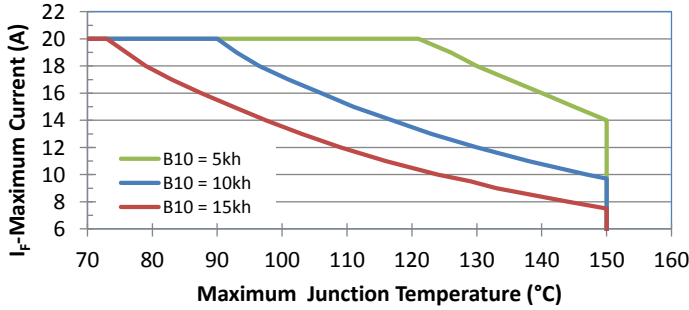
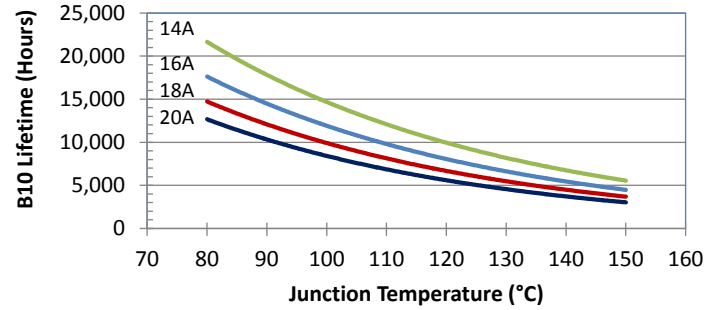

Note 9. Typical spectrum at current of 18 A in continuous operation.

**CBT-120-UV Reliability<sup>10</sup>**
**CBT120-UV Derating Curve  
B50 Lifetime (Median of Population)**

**CBT120-UV B50 Lifetime**

**CBT120-UV Derating Curve  
B10 Lifetime (10% of Population)**

**CBT120-UV B10 Lifetime**

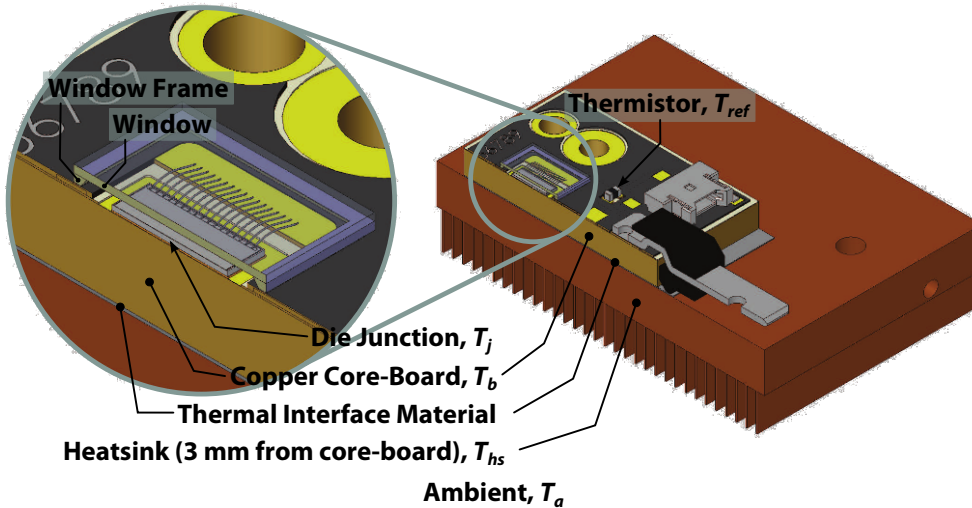
Note 10. Lifetime defined as time to 70% of initial intensity. Data can be used to model failure rate over typical product lifetime.



### Thermal Resistance CBT-120-UV-C31



#### Typical Thermal Resistance

$R_{\theta j-b}^1$	0.61 °C/W
$R_{\theta b-hs}^1$	0.12 °C/W
$R_{\theta j-hs}^2$	0.73 °C/W
$R_{\theta j-ref}^1$	0.64 °C/W

Note 1: Thermal resistance values are based on FEA model results correlated to measured  $R_{\theta j-hs}$  data.

Note 2: Thermal Resistance is based on eGraf 1205 Thermal interface.

### Thermal Resistance CBT-120-UV-C14

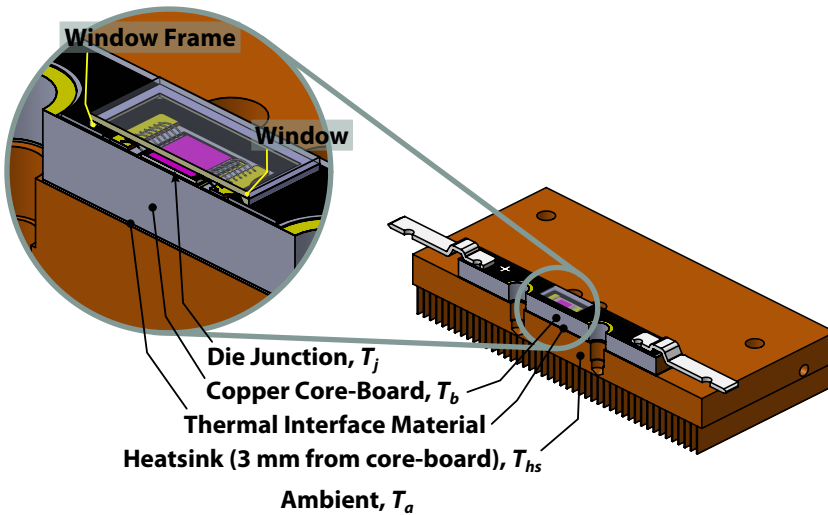

#### Typical Thermal Resistance

$R_{\theta j-b}^1$	0.76 °C/W
$R_{\theta b-hs}^1$	0.12 °C/W
$R_{\theta j-hs}^2$	0.88 °C/W

Note 1: Thermal resistance values are based on FEA model results correlated to measured  $R_{\theta j-hs}$  data.

Note 2: Thermal Resistance is based on Fujipoly Thermal interface.

### Electrical Pinout - C31 Package

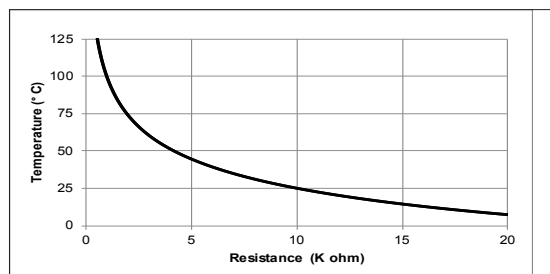
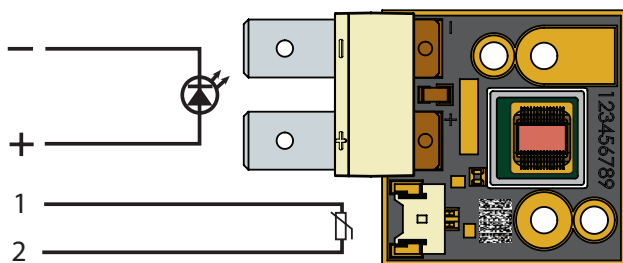

The thermistor used in CBT-120 devices mounted on coreboards is from Murata Manufacturing Co. The global part number is NCP18XH103J03RB. Please see <http://www.murata.com/> for details on calculating thermistor temperature.

For more information on use of the thermistor, please contact Luminus directly.

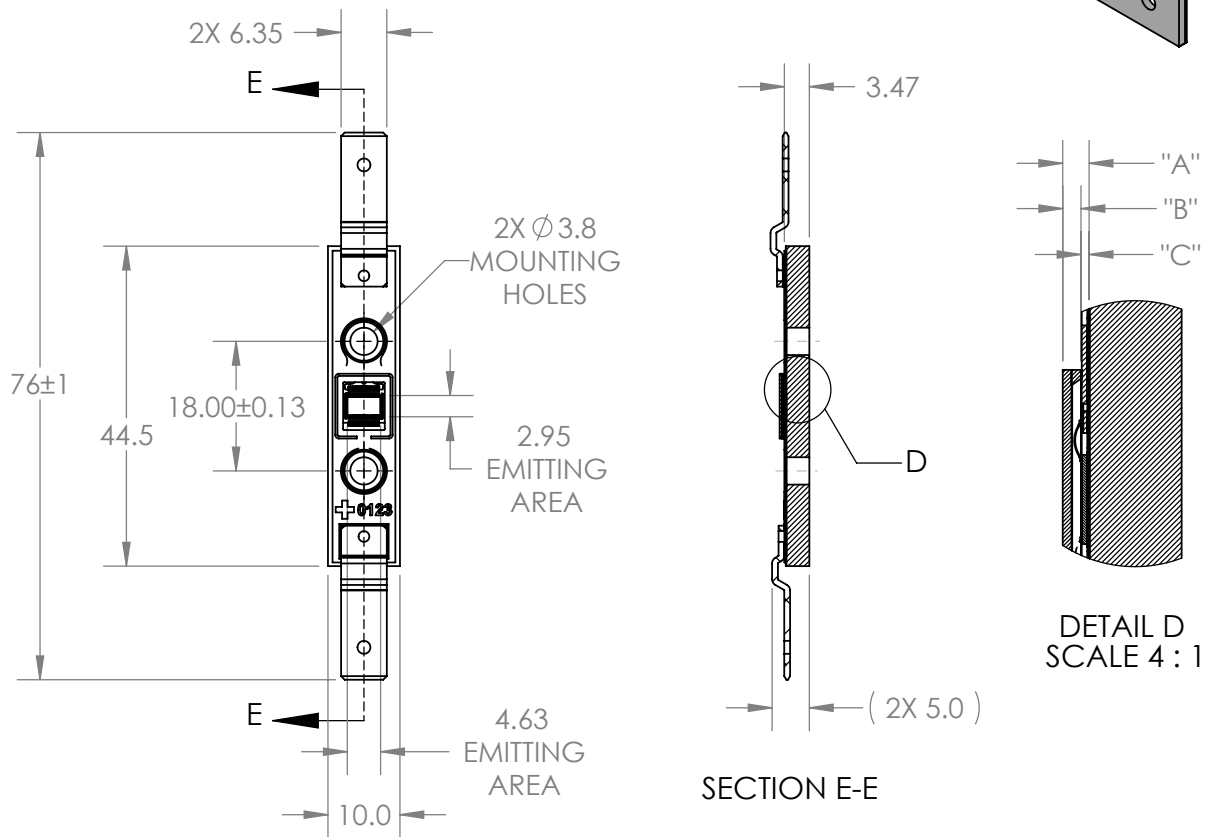
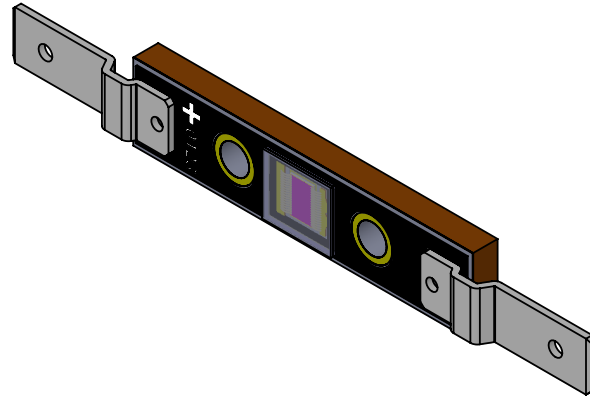
**Mechanical Dimensions – CBT-120-UV-C14 Emitter**

DIMENSIONS IN MILLIMETERS

DIMENSION NAME	DESCRIPTION	NOMINAL DIMENSION	TOLERANCE
"A"	TOP OF METAL SUBSTRATE TO TOP OF GLASS	.93	±0.07
"B"	TOP OF EMITTING AREA TO TOP OF GLASS	.64	±0.07
"C"	TOP OF METAL SUBSTRATE TO EMITTING AREA	.28	±0.05

Recommended connector for Anode and Cathode: Panduit Disco Lok™ Series P/N: DNG14-250FL-C.

DWG-001898

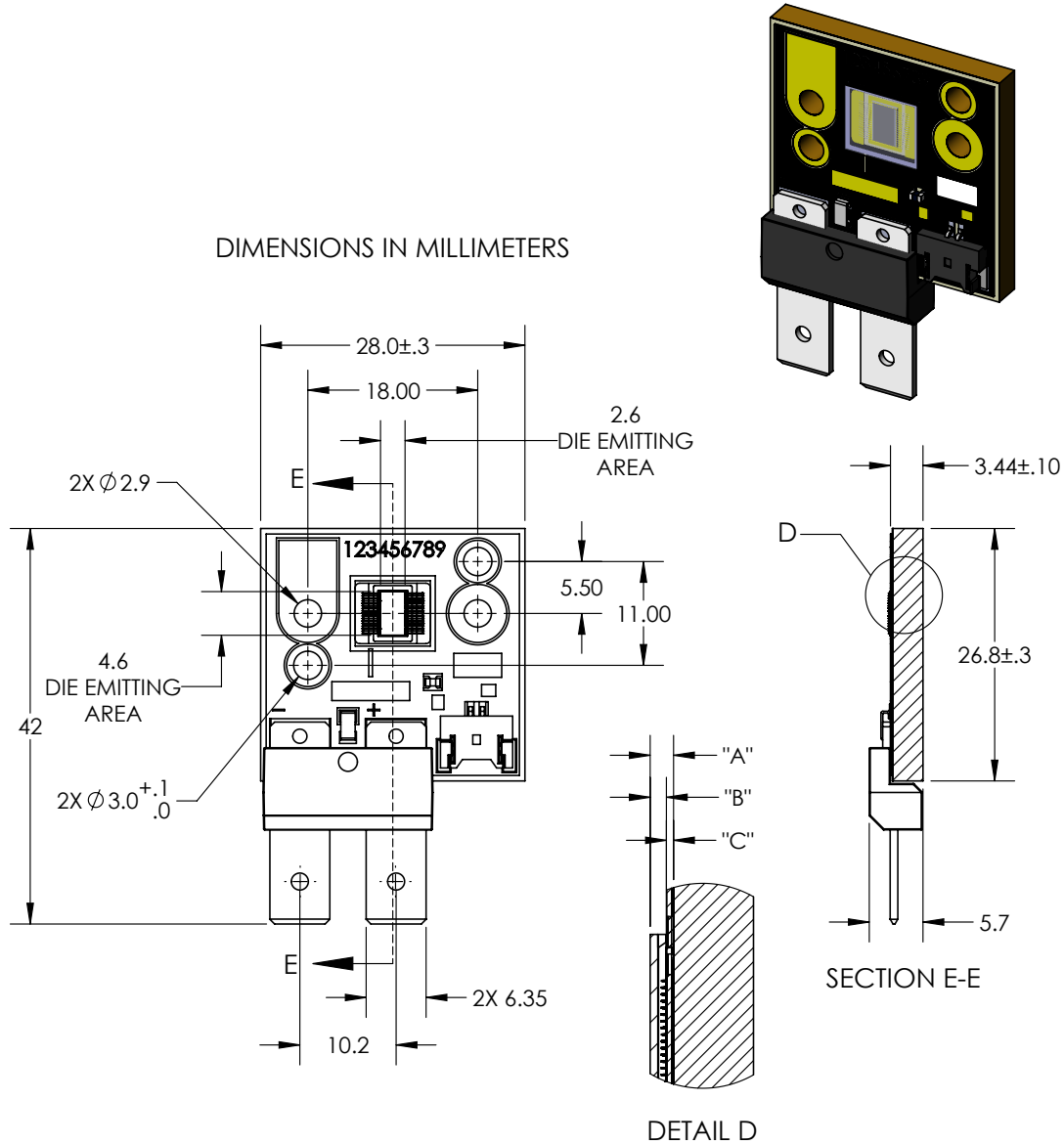
**Mechanical Dimensions – CBT-120-UV-C31 Emitter**

DIMENSION NAME	DESCRIPTION	NOMINAL DIMENSION	TOLERANCE
"A"	TOP OF METAL SUBSTRATE TO TOP OF WINDOW	0.91	±0.13
"B"	TOP OF DIE EMITTING AREA TO TOP OF WINDOW	0.61	±0.11
"C"	TOP OF METAL SUBSTRATE TO TOP OF DIE EMITTING AREA	0.27	±0.02

DWG-002179

Recommended connector for Anode and Cathode: Panduit Disco Lok™ Series P/N: DNG14-250FL-C.  
 Thermistor Connector: MOLEX P/N 53780-0270 or GCT P/N WTB08-021S-F.  
 Recommended Female: MOLEX P/N 51146-0200, GCT P/N WTB06-021S-F or equivalent

### Shipping Tray Outline - CBT-120-C14

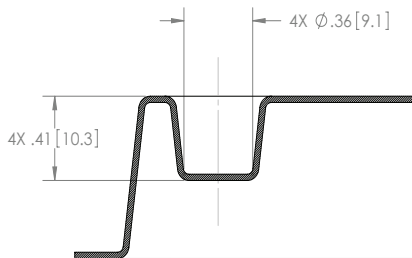
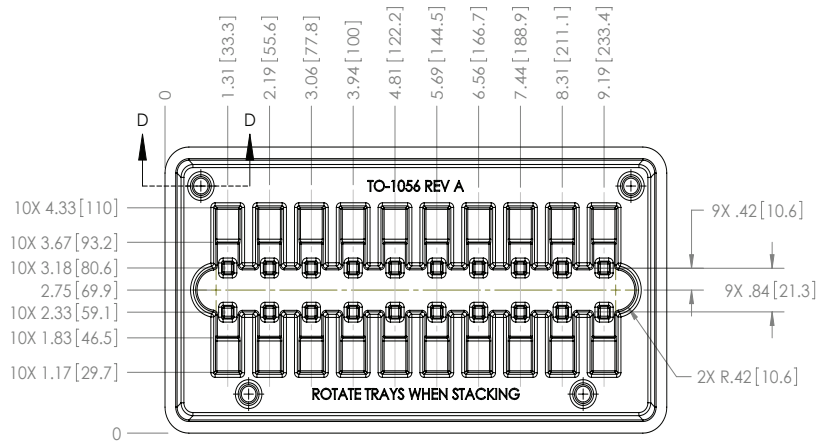

SECTION D-D  
SCALE 2:1

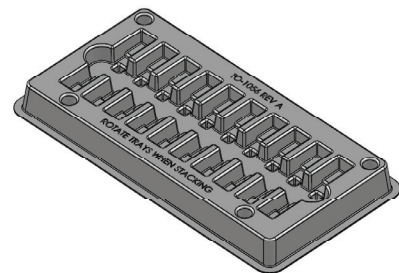

### Shipping Tray Outline - CBT-120-C31

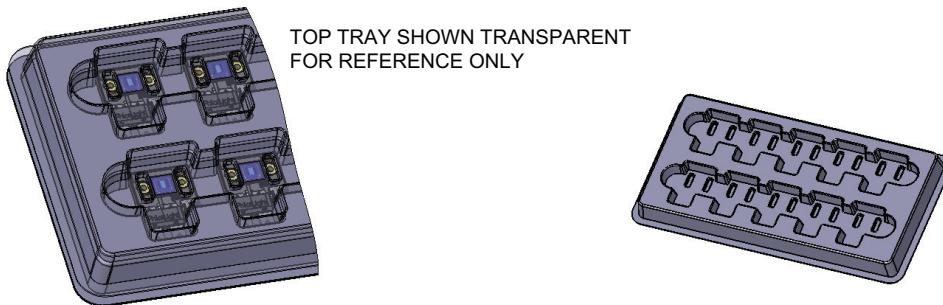
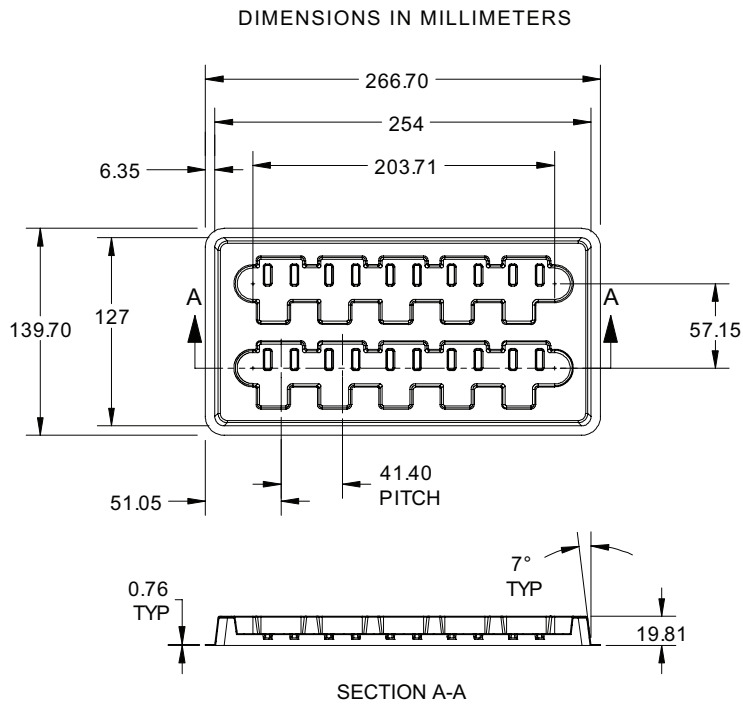

## Packing and Shipping Specification (CBT-120)

### Packing Specification

Packing Configuration	Qty /Pack	Box Dimensions (diameter x W, mm)	Gross Weight (kg)
Stack of 5 trays with 10 devices per tray Each pack is enclosed in ESD bag	50	140 x 280 x 70	2.7

### Product Label Specification

#### Label Fields (subject to change):

- 6-8 digit Box number (for Luminus internal use)
- Luminus ordering part number
- Quantity of devices in pack
- Part number revision (for Luminus internal use)
- Customer's part number (optional)
- Flux Bin
- 2D Bar code





**LUMINUS**  
LEADER IN BIG CHIP LEDS    Solid State Filament™

BT-012345  
  
Box number

PT-120-G-L11-MPG  
  
Luminus part number

12345678  
  
Customer part number

5F  
  
Bin

Qty: 50  

Rev 01  



for traceability peel off label and attach

**RoHS Compliant**

Sample label –for illustration only

### Shipping Box

Shipping Box	Quantity	Material	Dimensions (L x W x H, mm)
Carton Box	1 -20 packs (50 - 1000 Devices)	S4651	560 x 560 x 200





The products, their specifications and other information appearing in this document are subject to change by Luminus Devices without notice. Luminus Devices assumes no liability for errors that may appear in this document, and no liability otherwise arising from the application or use of the product or information contained herein. None of the information provided herein should be considered to be a representation of the fitness or suitability of the product for any particular application or as any other form of warranty. Luminus Devices' product warranties are limited to only such warranties as accompany a purchase contract or purchase order for such products. Nothing herein is to be construed as constituting an additional warranty. No information contained in this publication may be considered as a waiver by Luminus Devices of any intellectual property rights that Luminus Devices may have in such information. Big Chip LEDs™ is a registered trademark of Luminus Devices, Inc., all rights reserved.

This product is protected by U.S. Patents 6,831,302; 7,074,631; 7,083,993; 7,084,434; 7,098,589; 7,105,861; 7,138,666; 7,166,870; 7,166,871; 7,170,100; 7,196,354; 7,211,831; 7,262,550; 7,274,043; 7,301,271; 7,341,880; 7,344,903; 7,345,416; 7,348,603; 7,388,233; 7,391,059 Patents Pending in the U.S. and other countries.



## Стандарт Электрон Связь

Мы молодая и активно развивающаяся компания в области поставок электронных компонентов. Мы поставляем электронные компоненты отечественного и импортного производства напрямую от производителей и с крупнейших складов мира.

Благодаря сотрудничеству с мировыми поставщиками мы осуществляем комплексные и плановые поставки широчайшего спектра электронных компонентов.

Собственная эффективная логистика и склад в обеспечивает надежную поставку продукции в точно указанные сроки по всей России.

Мы осуществляем техническую поддержку нашим клиентам и предпродажную проверку качества продукции. На все поставляемые продукты мы предоставляем гарантию .

Осуществляем поставки продукции под контролем ВП МО РФ на предприятия военно-промышленного комплекса России , а также работаем в рамках 275 ФЗ с открытием отдельных счетов в уполномоченном банке. Система менеджмента качества компании соответствует требованиям ГОСТ ISO 9001.

Минимальные сроки поставки, гибкие цены, неограниченный ассортимент и индивидуальный подход к клиентам являются основой для выстраивания долгосрочного и эффективного сотрудничества с предприятиями радиоэлектронной промышленности, предприятиями ВПК и научно-исследовательскими институтами России.

С нами вы становитесь еще успешнее!

### Наши контакты:

**Телефон:** +7 812 627 14 35

**Электронная почта:** [sales@st-electron.ru](mailto:sales@st-electron.ru)

**Адрес:** 198099, Санкт-Петербург,  
Промышленная ул, дом № 19, литера Н,  
помещение 100-Н Офис 331