

### Features

- $V_{CE0} = 40V$
- $I_C = 200mA$
- Epitaxial Planar Die Construction
- Ideally Suited for Automated Assembly Processes
- **Lead, Halogen and Antimony Free, RoHS Compliant (Note 1)**
- **“Green” Device (Note 2)**
- **Ultra Small Package**

### Mechanical Data

- Case: SOT-963
- Case Material: Molded Plastic, “Green” Molding Compound. UL Flammability Classification Rating 94V-0
- Moisture Sensitivity: Level 1 per J-STD-020
- Terminals: Finish — Matte Tin annealed over Copper leadframe. Solderable per MIL-STD-202, Method 208
- Weight: 0.0027 grams (approximate)

SOT-963



Top View

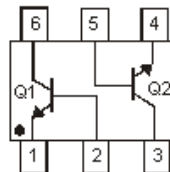

Device Schematic

### Ordering Information

Device	Packaging	Shipping
DST3904DJ-7	SOT-963	10,000/Tape & Reel

- Notes:
1. No purposefully added lead. Halogen and Antimony Free.
  2. Diodes Inc's “Green” Policy can be found on our website at <http://www.diodes.com>

### Marking Information

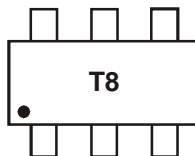

T8 = Product Type Marking Code

**Maximum Ratings** @T<sub>A</sub> = 25°C unless otherwise specified

Characteristic	Symbol	Value	Unit
Collector-Base Voltage	V <sub>CBO</sub>	60	V
Collector-Emitter Voltage	V <sub>CEO</sub>	40	V
Emitter-Base Voltage	V <sub>EBO</sub>	6.0	V
Collector Current - Continuous (Note 3)	I <sub>C</sub>	200	mA

**Thermal Characteristics**

Characteristic	Symbol	Value	Unit
Power Dissipation (Note 3)	P <sub>D</sub>	300	mW
Thermal Resistance, Junction to Ambient (Note 3)	R <sub>θJA</sub>	417	°C/W
Operating and Storage Temperature Range	T <sub>J</sub> , T <sub>STG</sub>	-55 to +150	°C

Notes: 3. Device mounted on FR-4 PCB with minimum recommended pad layout.

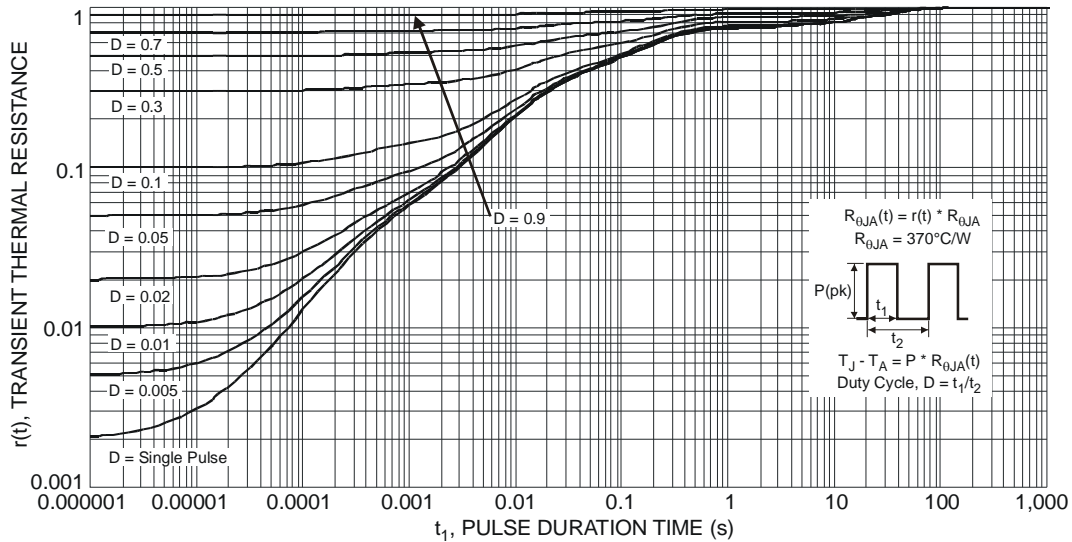

Fig. 1 Transient Thermal Response

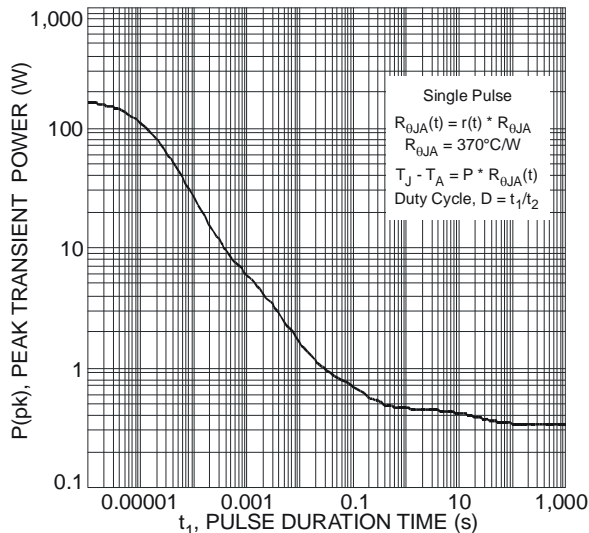

Fig. 2 Single Pulse Maximum Power Dissipation

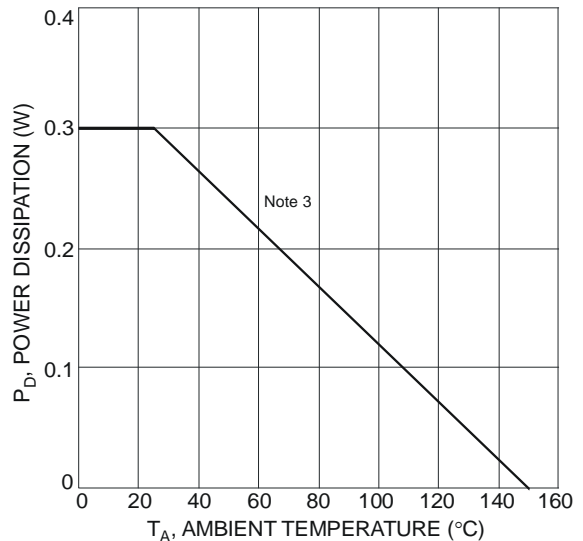

Fig. 3 Power Dissipation vs. Ambient Temperature

**Electrical Characteristics** @ $T_A = 25^\circ\text{C}$  unless otherwise specified

Characteristic	Symbol	Min	Max	Unit	Test Condition
<b>OFF CHARACTERISTICS</b>					
Collector-Base Breakdown Voltage	$V_{(BR)CBO}$	60	—	V	$I_C = 10\mu\text{A}, I_E = 0$
Collector-Emitter Breakdown Voltage (Note 4)	$V_{(BR)CEO}$	40	—	V	$I_C = 1.0\text{mA}, I_B = 0$
Emitter-Base Breakdown Voltage	$V_{(BR)EBO}$	6.0	—	V	$I_E = 10\mu\text{A}, I_C = 0$
Collector Cutoff Current	$I_{CEX}$	—	50	nA	$V_{CE} = 30\text{V}, V_{EB(OFF)} = 3.0\text{V}$
Base Cutoff Current	$I_{BL}$	—	50	nA	$V_{CE} = 30\text{V}, V_{EB(OFF)} = 3.0\text{V}$
<b>ON CHARACTERISTICS (Note 4)</b>					
DC Current Gain	$h_{FE}$	40	—	—	$I_C = 100\mu\text{A}, V_{CE} = 1.0\text{V}$
		70	—		$I_C = 1.0\text{mA}, V_{CE} = 1.0\text{V}$
		100	300		$I_C = 10\text{mA}, V_{CE} = 1.0\text{V}$
		60	—		$I_C = 50\text{mA}, V_{CE} = 1.0\text{V}$
		30	—		$I_C = 100\text{mA}, V_{CE} = 1.0\text{V}$
Collector-Emitter Saturation Voltage	$V_{CE(SAT)}$	—	0.20 0.30	V	$I_C = 10\text{mA}, I_B = 1.0\text{mA}$ $I_C = 50\text{mA}, I_B = 5.0\text{mA}$
Base-Emitter Saturation Voltage	$V_{BE(SAT)}$	0.65 —	0.85 0.95	V	$I_C = 10\text{mA}, I_B = 1.0\text{mA}$ $I_C = 50\text{mA}, I_B = 5.0\text{mA}$
<b>SMALL SIGNAL CHARACTERISTICS</b>					
Output Capacitance	$C_{obo}$	—	4.0	pF	$V_{CB} = 5.0\text{V}, f = 1.0\text{MHz}, I_E = 0$
Input Capacitance	$C_{ibo}$	—	8.5	pF	$V_{EB} = 0.5\text{V}, f = 1.0\text{MHz}, I_C = 0$
Input Impedance	$h_{ie}$	1.0	10	k $\Omega$	$V_{CE} = 10\text{V}, I_C = 1.0\text{mA}, f = 1.0\text{kHz}$
Voltage Feedback Ratio	$h_{re}$	0.5	8.0	$\times 10^{-4}$	
Small Signal Current Gain	$h_{fe}$	100	400	—	
Output Admittance	$h_{oe}$	1.0	40	$\mu\text{S}$	
Current Gain-Bandwidth Product	$f_T$	300	—	MHz	$V_{CE} = 20\text{V}, I_C = 10\text{mA}, f = 100\text{MHz}$
<b>SWITCHING CHARACTERISTICS</b>					
Delay Time	$t_d$	—	35	ns	$V_{CC} = 3.0\text{V}, I_C = 10\text{mA}, V_{BE(off)} = -0.5\text{V}, I_{B1} = 1.0\text{mA}$
Rise Time	$t_r$	—	35	ns	
Storage Time	$t_s$	—	200	ns	$V_{CC} = 3.0\text{V}, I_C = 10\text{mA}, I_{B1} = I_{B2} = 1.0\text{mA}$
Fall Time	$t_f$	—	50	ns	

Notes: 4. Measured under pulsed conditions. Pulse width = 300 $\mu\text{s}$ . Duty cycle  $\leq 2\%$

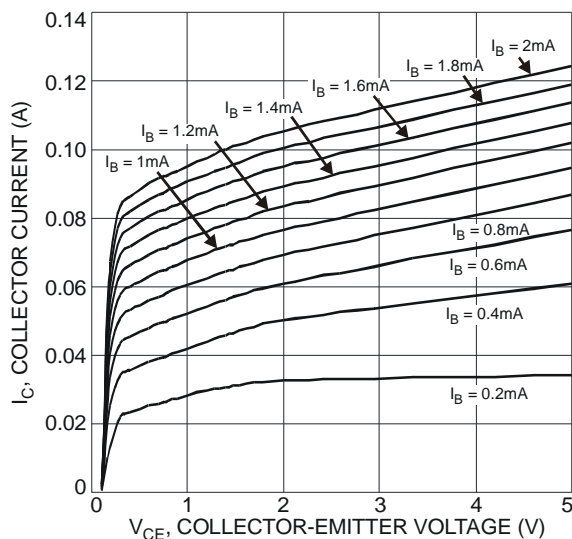

Fig. 4 Typical Collector Current vs. Collector-Emitter Voltage

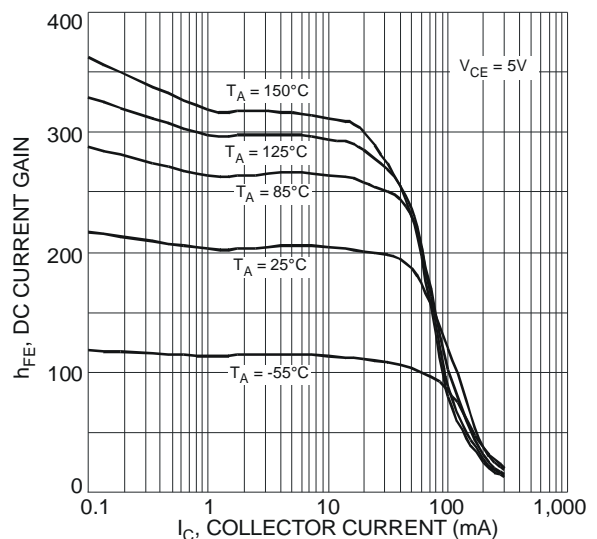

Fig. 5 Typical DC Current Gain vs. Collector Current

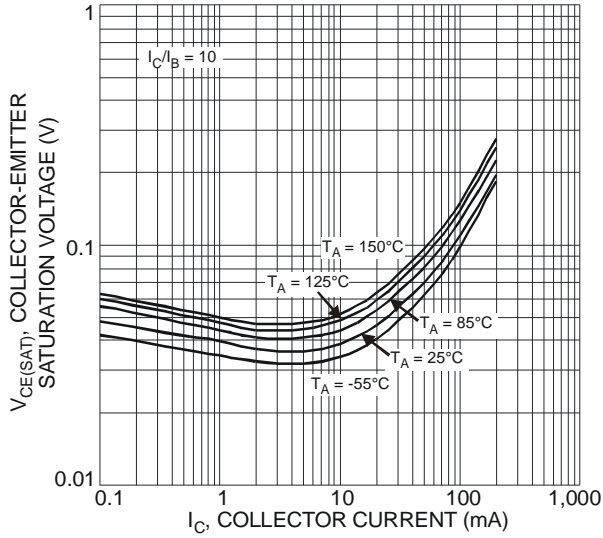

Fig. 6 Typical Collector-Emitter Saturation Voltage vs. Collector Current

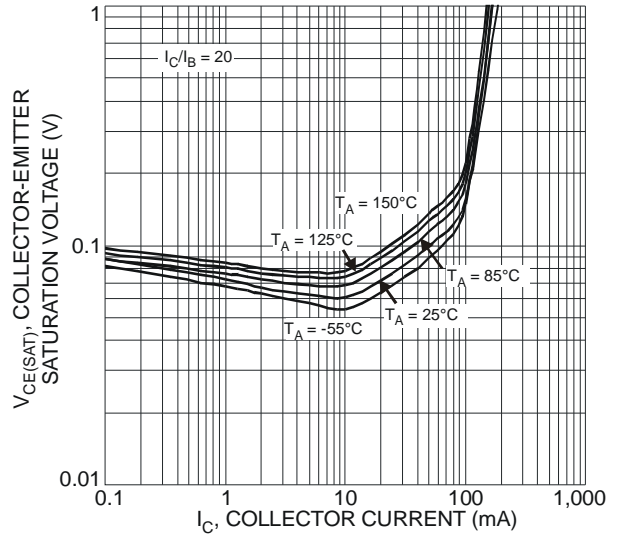

Fig. 7 Typical Collector-Emitter Saturation Voltage vs. Collector Current

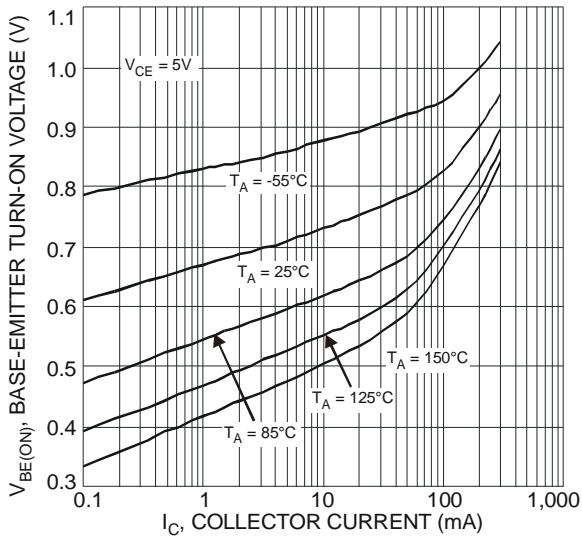

Fig. 8 Typical Base-Emitter Turn-On Voltage vs. Collector Current

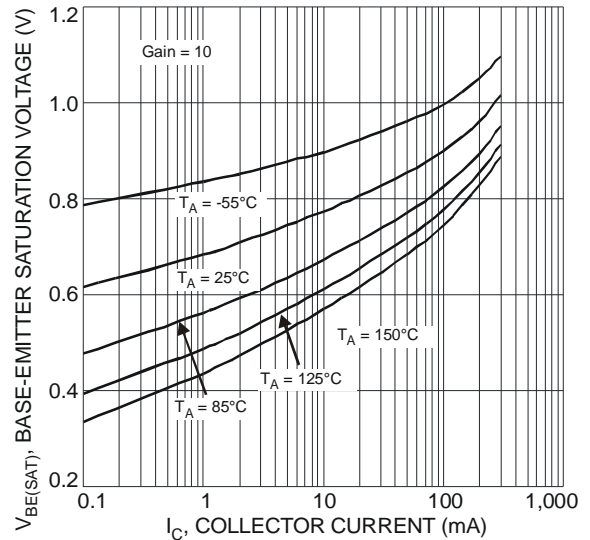

Fig. 9 Typical Base-Emitter Saturation Voltage vs. Collector Current

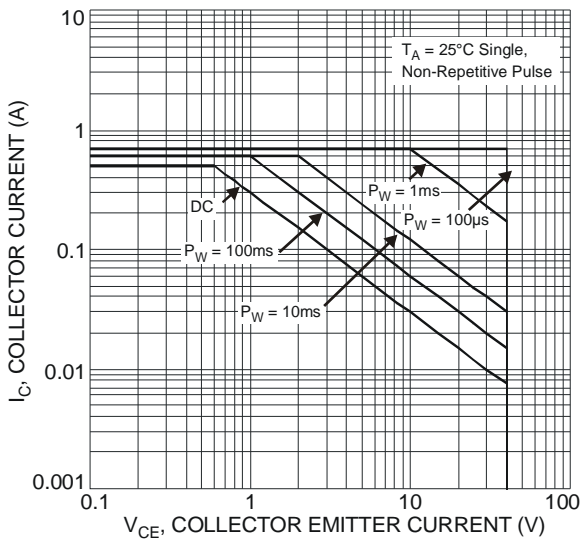
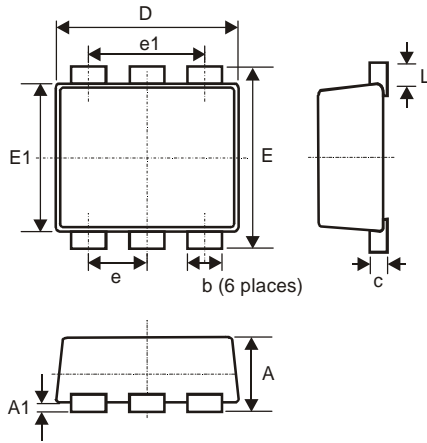

Fig. 10 Safe Operation Area (NPN)

**Package Outline Dimensions**



SOT-963			
Dim	Min	Max	Typ
A	0.40	0.50	0.45
A1	0	0.05	-
C	0.120	0.180	0.150
D	0.95	1.05	1.00
E	0.95	1.05	1.00
E1	0.75	0.85	0.80
L	0.05	0.15	0.10
b	0.10	0.20	0.15
e	0.35 Typ		
e1	0.70 Typ		
All Dimensions in mm			

**Suggest Pad Layout**

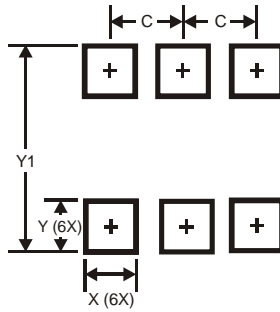

Dimensions	Value (in mm)
C	0.350
X	0.200
Y	0.200
Y1	1.100

**IMPORTANT NOTICE**

DIODES INCORPORATED MAKES NO WARRANTY OF ANY KIND, EXPRESS OR IMPLIED, WITH REGARDING TO THIS DOCUMENT, INCLUDING, BUT NOT LIMITED TO, THE IMPLIED WARRANTIES OF MERCHANTABILITY AND FITNESS FOR A PARTICULAR PURPOSE (AND THEIR EQUIVALENTS UNDER THE LAWS OF ANY JURISDICTION).

Diodes Incorporated and its subsidiaries reserve the right to make modifications, enhancements, improvements, corrections or other changes without further notice to this document and any product described herein. Diodes Incorporated does not assume any liability arising out of the application or use of this document or any product described herein; neither does Diodes Incorporated convey any license under its patent or trademark rights, nor the rights of others. Any Customer or user of this document or products described herein in such applications shall assume all risks of such use and will agree to hold Diodes Incorporated and all the companies whose products are represented on Diodes Incorporated website, harmless against all damages.

Diodes Incorporated does not warrant or accept any liability whatsoever in respect of any products purchased through unauthorized sales channel. Should Customers purchase or use Diodes Incorporated products for any unintended or unauthorized application, Customers shall indemnify and hold Diodes Incorporated and its representatives harmless against all claims, damages, expenses, and attorney fees arising out of, directly or indirectly, any claim of personal injury or death associated with such unintended or unauthorized application.

Products described herein may be covered by one or more United States, international or foreign patents pending. Product names and markings noted herein may also be covered by one or more United States, international or foreign trademarks.

**LIFE SUPPORT**

Diodes Incorporated products are specifically not authorized for use as critical components in life support devices or systems without the express written approval of the Chief Executive Officer of Diodes Incorporated. As used herein:

A. Life support devices or systems are devices or systems which:

1. are intended to implant into the body, or
2. support or sustain life and whose failure to perform when properly used in accordance with instructions for use provided in the labeling can be reasonably expected to result in significant injury to the user.

B. A critical component is any component in a life support device or system whose failure to perform can be reasonably expected to cause the failure of the life support device or to affect its safety or effectiveness.

Customers represent that they have all necessary expertise in the safety and regulatory ramifications of their life support devices or systems, and acknowledge and agree that they are solely responsible for all legal, regulatory and safety-related requirements concerning their products and any use of Diodes Incorporated products in such safety-critical, life support devices or systems, notwithstanding any devices- or systems-related information or support that may be provided by Diodes Incorporated. Further, Customers must fully indemnify Diodes Incorporated and its representatives against any damages arising out of the use of Diodes Incorporated products in such safety-critical, life support devices or systems.

Copyright © 2010, Diodes Incorporated

[www.diodes.com](http://www.diodes.com)



## Стандарт Электрон Связь

Мы молодая и активно развивающаяся компания в области поставок электронных компонентов. Мы поставляем электронные компоненты отечественного и импортного производства напрямую от производителей и с крупнейших складов мира.

Благодаря сотрудничеству с мировыми поставщиками мы осуществляем комплексные и плановые поставки широчайшего спектра электронных компонентов.

Собственная эффективная логистика и склад в обеспечивает надежную поставку продукции в точно указанные сроки по всей России.

Мы осуществляем техническую поддержку нашим клиентам и предпродажную проверку качества продукции. На все поставляемые продукты мы предоставляем гарантию .

Осуществляем поставки продукции под контролем ВП МО РФ на предприятия военно-промышленного комплекса России , а также работаем в рамках 275 ФЗ с открытием отдельных счетов в уполномоченном банке. Система менеджмента качества компании соответствует требованиям ГОСТ ISO 9001.

Минимальные сроки поставки, гибкие цены, неограниченный ассортимент и индивидуальный подход к клиентам являются основой для выстраивания долгосрочного и эффективного сотрудничества с предприятиями радиоэлектронной промышленности, предприятиями ВПК и научно-исследовательскими институтами России.

С нами вы становитесь еще успешнее!

### Наши контакты:

**Телефон:** +7 812 627 14 35

**Электронная почта:** [sales@st-electron.ru](mailto:sales@st-electron.ru)

**Адрес:** 198099, Санкт-Петербург,  
Промышленная ул, дом № 19, литера Н,  
помещение 100-Н Офис 331