

ZXMN3A04DN8

DUAL 30V N-CANNEL ENHANCEMENT MODE MOSFET

SUMMARY

$V_{(BR)DSS} = 30V$; $R_{DS(ON)} = 0.02\Omega$; $I_D = 8.5A$

DESCRIPTION

This new generation of TRENCH MOSFETs from Zetex utilizes a unique structure that combines the benefits of low on-resistance with fast switching speed. This makes them ideal for high efficiency, low voltage, power management applications.

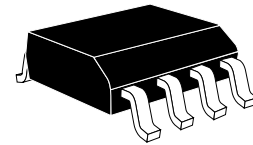

SO8

FEATURES

- Low on-resistance
- Fast switching speed
- Low threshold
- Low gate drive
- Low profile SOIC package

APPLICATIONS

- DC - DC Converters
- Power Management Functions
- Disconnect switches
- Motor control

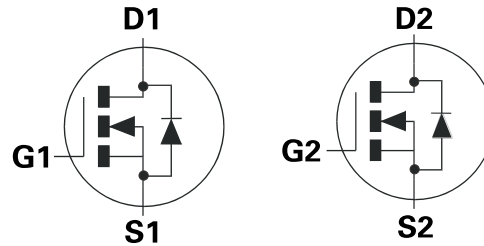

ORDERING INFORMATION

DEVICE	REEL	TAPE WIDTH	QUANTITY PER REEL
ZXMN3A04DN8TA	7"	12mm	500 units
ZXMN3A04DN8TC	13"	12mm	2500 units

DEVICE MARKING

ZXMN
3A04D

PINOUT

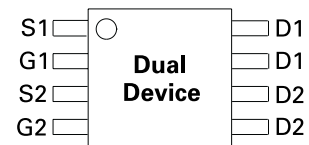

Top view

ZXMN3A04DN8

ABSOLUTE MAXIMUM RATINGS.

PARAMETER	SYMBOL	LIMIT	UNIT
Drain-Source Voltage	V_{DSS}	30	V
Gate Source Voltage	V_{GS}	± 20	V
Continuous Drain Current ($V_{GS}=10V$; $T_A=25^\circ C$)(b)(d) ($V_{GS}=10V$; $T_A=70^\circ C$)(b)(d) ($V_{GS}=10V$; $T_A=25^\circ C$)(a)(d)	I_D	8.5 6.8 6.5	A
Pulsed Drain Current (c)	I_{DM}	39	A
Continuous Source Current (Body Diode) (b)	I_S	3.6	A
Pulsed Source Current (Body Diode)(c)	I_{SM}	39	A
Power Dissipation at $T_A=25^\circ C$ (a)(d) Linear Derating Factor	P_D	1.25 10	W mW/ $^\circ C$
Power Dissipation at $T_A=25^\circ C$ (a)(e) Linear Derating Factor	P_D	1.81 14.5	W mW/ $^\circ C$
Power Dissipation at $T_A=25^\circ C$ (b)(d) Linear Derating Factor	P_D	2.15 17.2	W mW/ $^\circ C$
Operating and Storage Temperature Range	T_J : T_{stg}	-55 to +150	$^\circ C$

THERMAL RESISTANCE

PARAMETER	SYMBOL	VALUE	UNIT
Junction to Ambient (a)(d)	$R_{\theta JA}$	100	$^\circ C/W$
Junction to Ambient (b)(e)	$R_{\theta JA}$	69	$^\circ C/W$
Junction to Ambient (b)(d)	$R_{\theta JA}$	58	$^\circ C/W$

Notes

- (a) For a dual device surface mounted on 25mm x 25mm FR4 PCB with coverage of single sided 1oz copper in still air conditions.
 (b) For a dual device surface mounted on FR4 PCB measured at $t \leq 10$ sec.
 (c) Repetitive rating 25mm x 25mm FR4 PCB, $D=0.02$ pulse width=300 μs - pulse width limited by maximum junction temperature. Refer to Transient Thermal Impedance Graph.
 (d) For a dual device with one active die.



ZXMN3A04DN8

CHARACTERISTICS

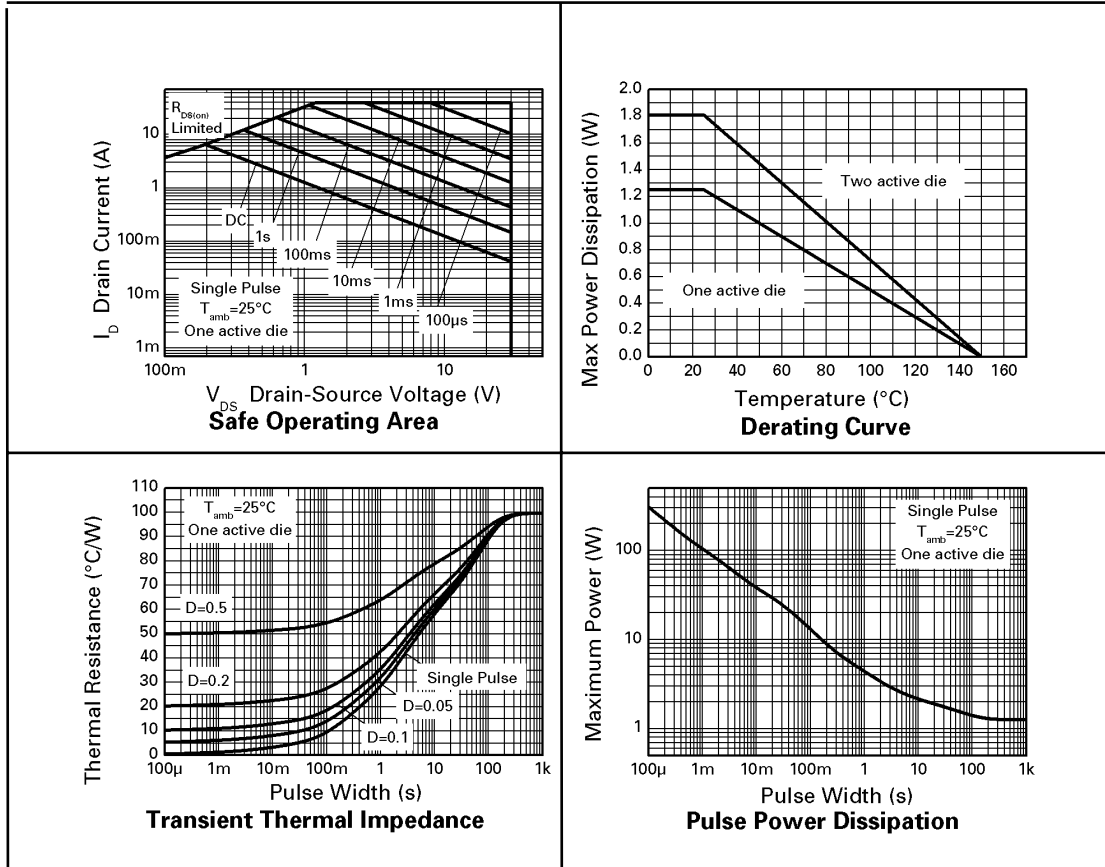

ZXMN3A04DN8

ELECTRICAL CHARACTERISTICS (at $T_A = 25^\circ\text{C}$ unless otherwise stated).

PARAMETER	SYMBOL	MIN.	TYP.	MAX.	UNIT	CONDITIONS.
STATIC						
Drain-Source Breakdown Voltage	$V_{(BR)DSS}$	30			V	$I_D=250\mu\text{A}, V_{GS}=0\text{V}$
Zero Gate Voltage Drain Current	I_{DSS}			0.5	μA	$V_{DS}=30\text{V}, V_{GS}=0\text{V}$
Gate-Body Leakage	I_{GSS}			100	nA	$V_{GS}=\pm 20\text{V}, V_{DS}=0\text{V}$
Gate-Source Threshold Voltage	$V_{GS(th)}$	1.0			V	$I_D=250\mu\text{A}, V_{DS}=V_{GS}$
Static Drain-Source On-State Resistance (1)	$R_{DS(on)}$			0.02 0.03	Ω Ω	$V_{GS}=10\text{V}, I_D=12.6\text{A}$ $V_{GS}=4.5\text{V}, I_D=10.6\text{A}$
Forward Transconductance (3)	g_{fs}		22.1		S	$V_{DS}=15\text{V}, I_D=12.6\text{A}$
DYNAMIC (3)						
Input Capacitance	C_{iss}		1890		pF	$V_{DS}=15\text{V}, V_{GS}=0\text{V},$ $f=1\text{MHz}$
Output Capacitance	C_{oss}		349		pF	
Reverse Transfer Capacitance	C_{rss}		218		pF	
SWITCHING(2) (3)						
Turn-On Delay Time	$t_{d(on)}$		5.2		ns	$V_{DD}=15\text{V}, I_D=1\text{A}$ $R_G=6.0\Omega, V_{GS}=10\text{V}$
Rise Time	t_r		6.1		ns	
Turn-Off Delay Time	$t_{d(off)}$		38.1		ns	
Fall Time	t_f		20.2		ns	
Gate Charge	Q_g		19.9		nC	$V_{DS}=15\text{V}, V_{GS}=5\text{V},$ $I_D=6.5\text{A}$
Total Gate Charge	Q_g		36.8		nC	$V_{DS}=15\text{V}, V_{GS}=10\text{V},$ $I_D=6.5\text{A}$
Gate-Source Charge	Q_{gs}		5.8		nC	
Gate-Drain Charge	Q_{gd}		7.1		nC	
SOURCE-DRAIN DIODE						
Diode Forward Voltage (1)	V_{SD}		0.85	0.95	V	$T_J=25^\circ\text{C}, I_S=6.8\text{A},$ $V_{GS}=0\text{V}$
Reverse Recovery Time (3)	t_{rr}		18.4		ns	$T_J=25^\circ\text{C}, I_F=2.3\text{A},$ $di/dt=100\text{A}/\mu\text{s}$
Reverse Recovery Charge (3)	Q_{rr}		11		nC	

NOTES

- (1) Measured under pulsed conditions. Width=300 μs . Duty cycle $\leq 2\%$.
 (2) Switching characteristics are independent of operating junction temperature.
 (3) For design aid only, not subject to production testing.



ISSUE 2 - OCTOBER 2002

ZXMN3A04DN8

TYPICAL CHARACTERISTICS

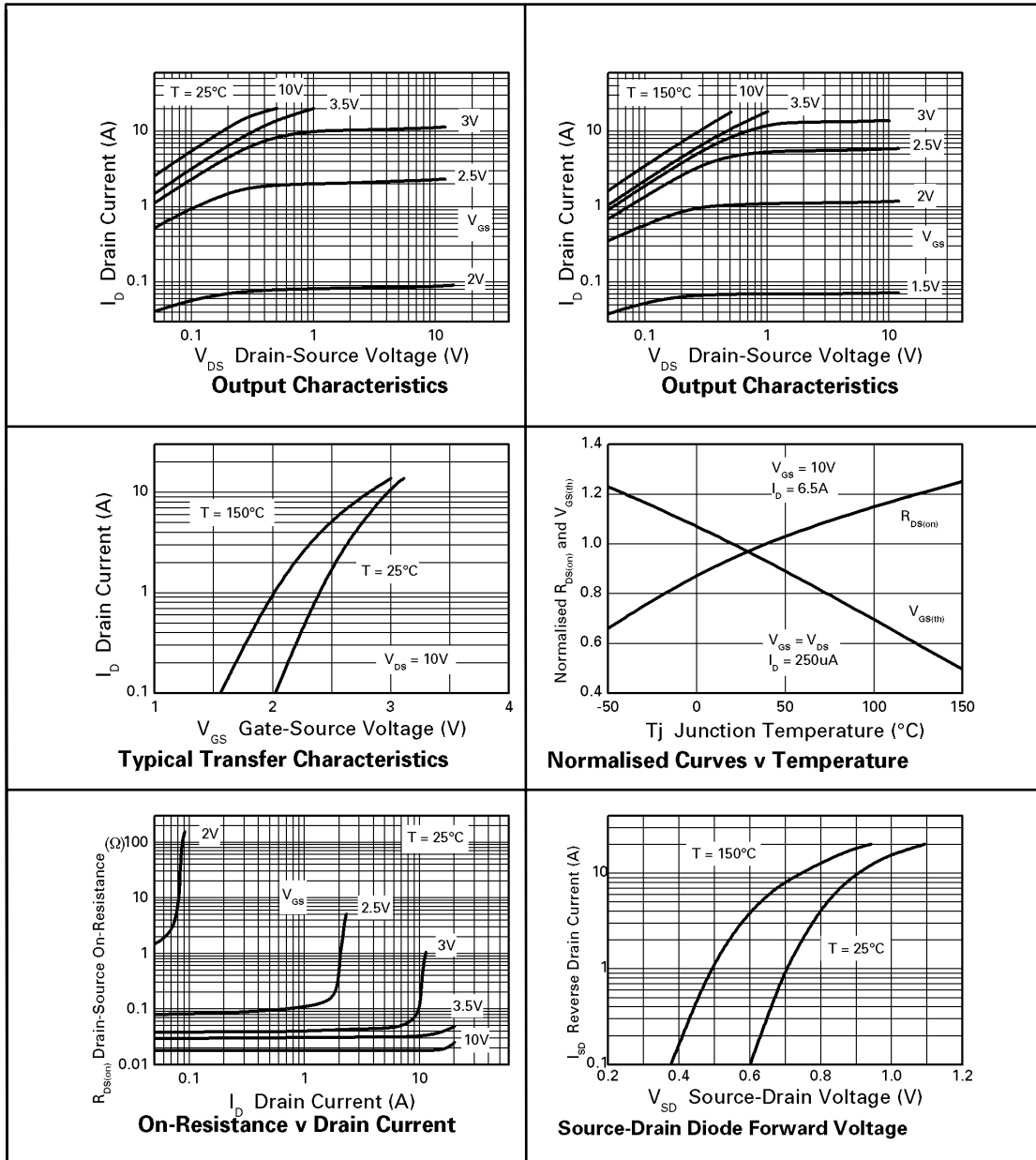

ZXMN3A04DN8

TYPICAL CHARACTERISTICS

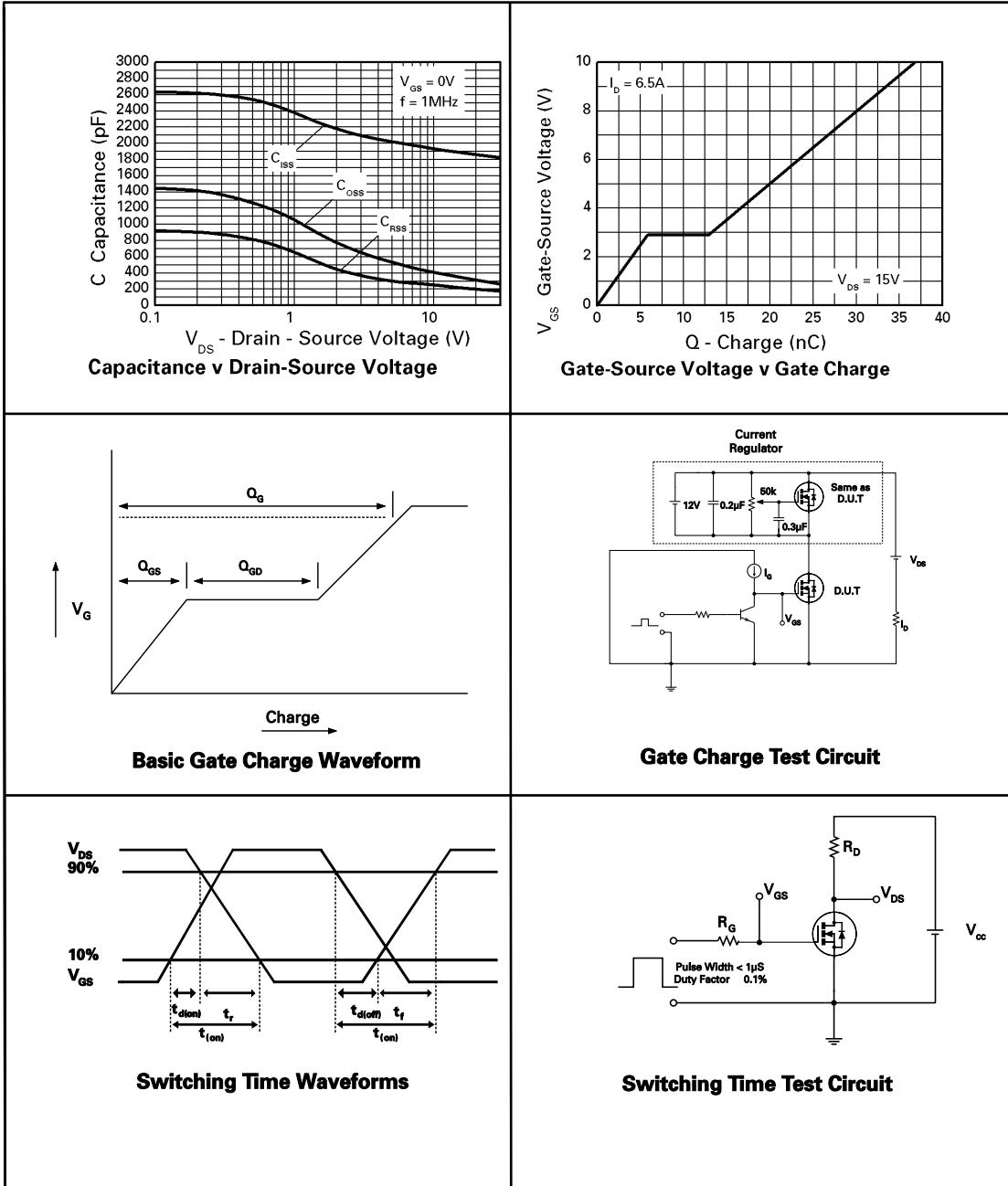

ZXMN3A04DN8

PACKAGE OUTLINE

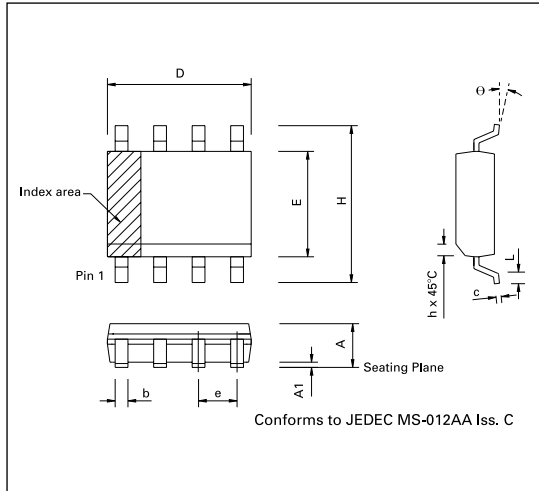

CONTROLLING DIMENSIONS ARE IN INCHES
APPROX IN MILLIMETRES

PACKAGE DIMENSIONS

DIM	INCHES		MILLIMETRES	
	MIN	MAX	MIN	MAX
A	0.053	0.069	1.35	1.75
A1	0.004	0.010	0.10	0.25
D	0.189	0.197	4.80	5.00
H	0.228	0.244	5.80	6.20
E	0.150	0.157	3.80	4.00
L	0.016	0.050	0.40	1.27
e	0.050 BSC		1.27 BSC	
b	0.013	0.020	0.33	0.51
c	0.008	0.010	0.19	0.25
θ	0°	8°	0°	8°
h	0.010	0.020	0.25	0.50

© Zetex plc 2002

Europe

Zetex plc
Fields New Road
Chadderton
Oldham, OL9 8NP
United Kingdom
Telephone: (44) 161 622 4422
Fax: (44) 161 622 4420
uk.sales@zetex.com

Zetex GmbH
Streitfeldstraße 19
D-81673 München
Germany
Telefon: (49) 89 45 49 49 0
Fax: (49) 89 45 49 49 49
europe.sales@zetex.com

Americas

Zetex Inc
700 Veterans Memorial Hwy
Hauppauge, NY11788
USA
Telephone: (631) 360 2222
Fax: (631) 360 8222
usa.sales@zetex.com

Asia Pacific

Zetex (Asia) Ltd
3701-04 Metroplaza, Tower 1
Hing Fong Road
Kwai Fong
Hong Kong
Telephone: (852) 26100 611
Fax: (852) 24250 494
asia.sales@zetex.com

These offices are supported by agents and distributors in major countries world-wide.

This publication is issued to provide outline information only which (unless agreed by the Company in writing) may not be used, applied or reproduced for any purpose or form part of any order or contract or be regarded as a representation relating to the products or services concerned. The Company reserves the right to alter without notice the specification, design, price or conditions of supply of any product or service.

For the latest product information, log on to www.zetex.com

ISSUE 2 - OCTOBER 2002

ZETEX



Стандарт Электрон Связь

Мы молодая и активно развивающаяся компания в области поставок электронных компонентов. Мы поставляем электронные компоненты отечественного и импортного производства напрямую от производителей и с крупнейших складов мира.

Благодаря сотрудничеству с мировыми поставщиками мы осуществляем комплексные и плановые поставки широчайшего спектра электронных компонентов.

Собственная эффективная логистика и склад в обеспечивает надежную поставку продукции в точно указанные сроки по всей России.

Мы осуществляем техническую поддержку нашим клиентам и предпродажную проверку качества продукции. На все поставляемые продукты мы предоставляем гарантию .

Осуществляем поставки продукции под контролем ВП МО РФ на предприятия военно-промышленного комплекса России , а также работаем в рамках 275 ФЗ с открытием отдельных счетов в уполномоченном банке. Система менеджмента качества компании соответствует требованиям ГОСТ ISO 9001.

Минимальные сроки поставки, гибкие цены, неограниченный ассортимент и индивидуальный подход к клиентам являются основой для выстраивания долгосрочного и эффективного сотрудничества с предприятиями радиоэлектронной промышленности, предприятиями ВПК и научно-исследовательскими институтами России.

С нами вы становитесь еще успешнее!

Наши контакты:

Телефон: +7 812 627 14 35

Электронная почта: sales@st-electron.ru

Адрес: 198099, Санкт-Петербург,
Промышленная ул, дом № 19, литера Н,
помещение 100-Н Офис 331