

### Applications

- Commercial and Military Radar
- Electronic Warfare
- Satellite Communications
- Point to Point Radio
- General Purpose

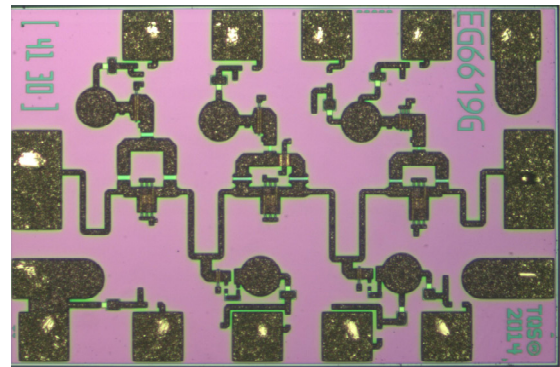

### Product Features

- Frequency Range: 0.1-31 GHz
- 5-Bit Digital Attenuator
- Attenuation Step Size (LSB): 0.5 dB
- Attenuation Range: 15.5 dB
- Insertion Loss (Ref. State): 1.8-4.2 dB
- RMS Attenuation Error: < 0.9 dB
- RMS Step Error: < 0.4 dB
- Control Voltage: -3.3 to -5.0 V
- Die Size: 1.180 x 0.800 x 0.100 mm

### Functional Block Diagram

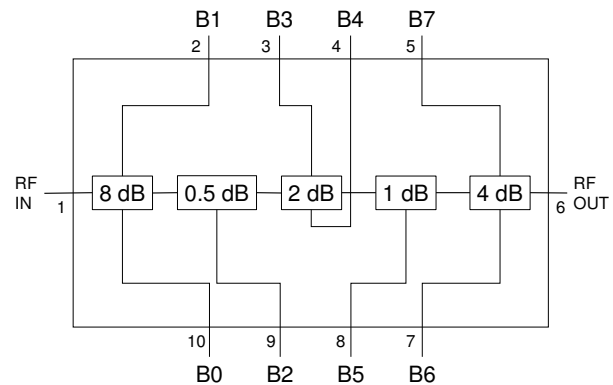

### General Description

TriQuint's TGL2223 is a wideband, 5-bit digital attenuator using TriQuint's TQPHT15 production 0.15um GaAs pHEMT process. Operating from 0.1 - 31 GHz, the TGL2223 offers a low LSB of 0.5 dB and supports > 15.5 dB of attenuation range with a low RMS step error of < 0.5 dB.

Using standard, negative control voltages from -3.3 to -5 V coupled with excellent broadband performance, the TGA2223 is ideal for supporting of a variety of commercial and military applications.

The TGL2223 is in die form, 1.180 x 0.800 x 0.100 mm, with both RF ports matched to 50 ohms for simple system integration.

Lead-free and RoHS compliant.

Evaluation Boards available on request.

### Pad Configuration

Pad Number	Symbol
1	RF Input
2	Compl. control line for 8.0 dB bit
3	Compl. control line for 2.0 dB bit
4	Compl. control line for 2.0 dB bit
5	Compl. control line for 4.0 dB bit
6	RF Output
7	Compl. control line for 4.0 dB bit
8	Control line for 1.0 dB bit
9	Control line for 0.5 dB bit
10	Compl. control line for 8.0 dB bit

### Ordering Information

Part	ECCN	Description
TGL2223	EAR99	0.1-31 GHz 5-Bit Digital Attenuator

### Absolute Maximum Ratings

Parameter	Value
Control Voltage ( $V_C$ )	-6 V
Control Current ( $I_C$ )	1 mA
Input Power ( $P_{IN}$ )	30 dBm
Power Dissipation ( $P_{DISS}$ )	0.7 W
Operating Channel Temperature	150 °C

Operation of this device outside the parameter ranges given above may cause permanent damage. These are stress ratings only, and functional operation of the device at these conditions is not implied.

### Recommended Operating Conditions

Parameter	Value
Control Voltage (logic L)	-3.3 to -5 V
Control Voltage (logic H)	0 V

Electrical specifications are measured at specified test conditions. Specifications are not guaranteed over all recommended operating conditions.

### Electrical Specifications

Test conditions, unless otherwise noted: 25 °C,  $V_C = 0 / -5.0$  V. Tested with DUT on EVB

Parameter	Min	Typical	Max	Units
Frequency Range	0.1		31	GHz
LSB Attenuation		0.5		dB
Attenuation range		15.5		dB
Reference State Insertion Loss: 1-6 GHz		< 1.9		dB
Reference State Insertion Loss: 6-18 GHz		< 2.7		dB
Reference State Insertion Loss: 18-31 GHz		< 4.2		dB
Input Return Loss		> 12		dB
Output Return Loss		> 9		dB
IIP3 ( $\Delta f = 1.0$ MHz, $P_{IN}/\text{Tone} = 5$ dBm, 14 GHz, all states)		> 26		dBm
Switching Speed (10%-90%, 90%-10%)		< 30		ns
RMS Attenuation Error		< 0.9		dB
RMS Step Error		< 0.4		dB
Max. Attenuation Error		< 2.4		dB

**Specifications**

**Thermal and Reliability Information**

Parameter	Conditions	Value	Units
Thermal Resistance ( $\theta_{JC}$ ) <sup>(1)</sup>	$T_{BASE} = 85\text{ }^{\circ}\text{C}$ , $V_C = -5.0\text{ V}$ , $P_{DISS} = 0.22\text{ W}$	103.6	$^{\circ}\text{C/W}$
Channel Temperature ( $T_{CH}$ ) <sup>(1)</sup>		108	$^{\circ}\text{C}$
Median Lifetime ( $T_M$ )		2.24E08	Hrs

Note:

- 1. Carrier plate backside temperature fixed at 85  $^{\circ}\text{C}$ .

**Median Lifetime**

Test Conditions: 6.0 V; Failure Criterion = 10% reduction in  $I_{D\text{ MAX}}$

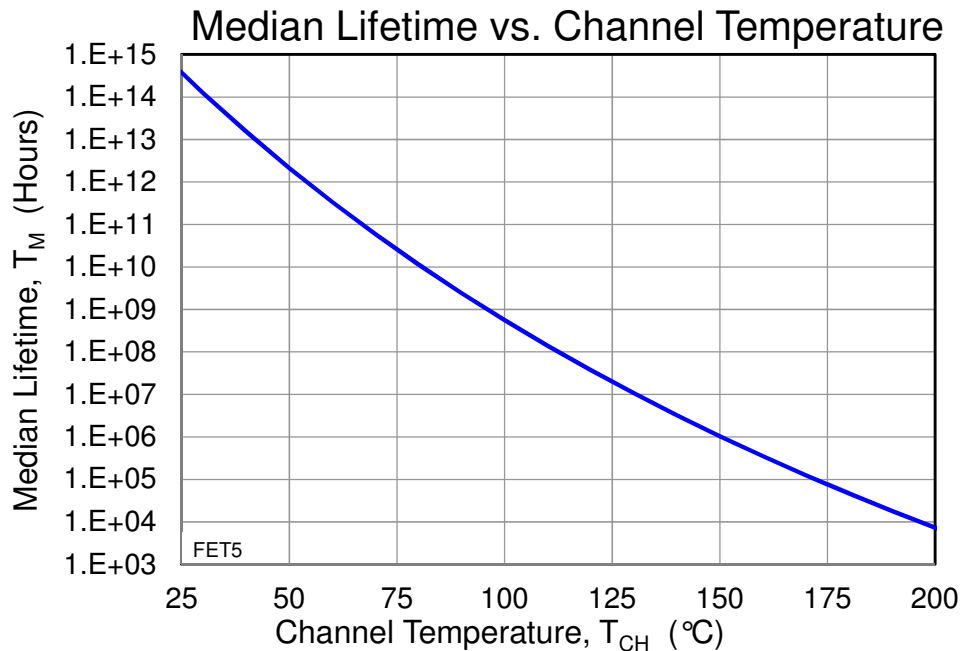

**Typical Performance**

Test conditions unless otherwise noted: Tested with DUT on EVB

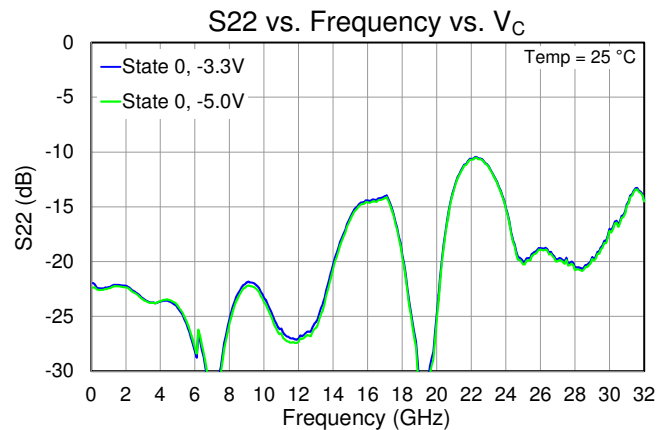
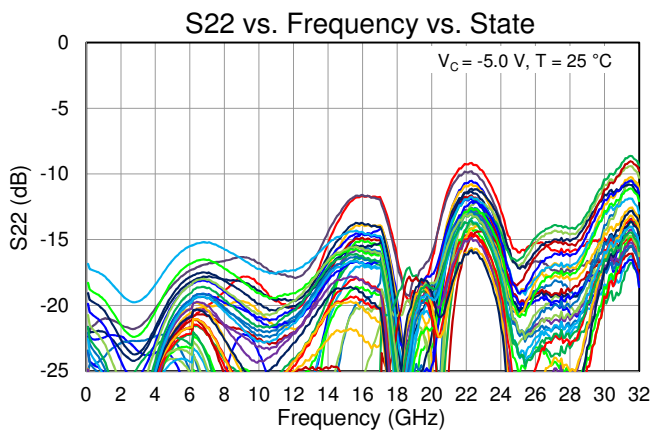
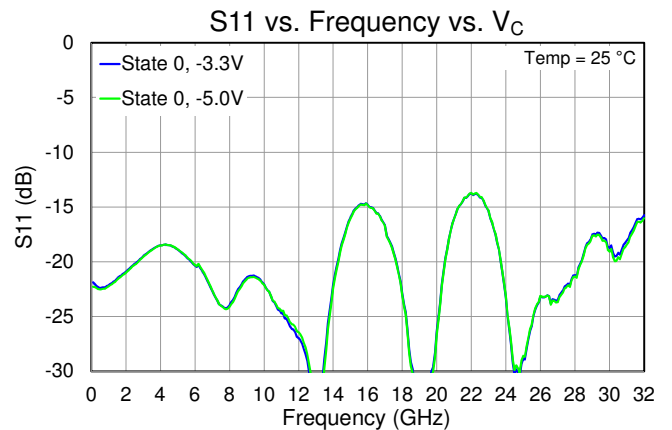
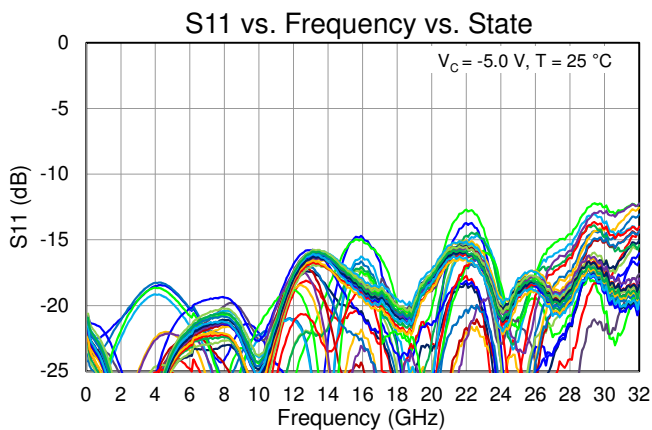
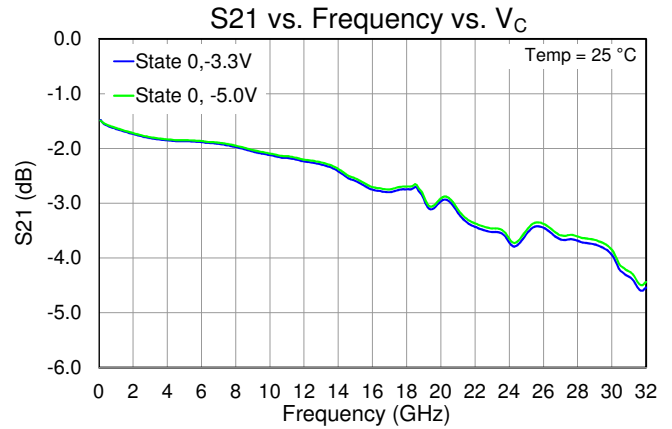
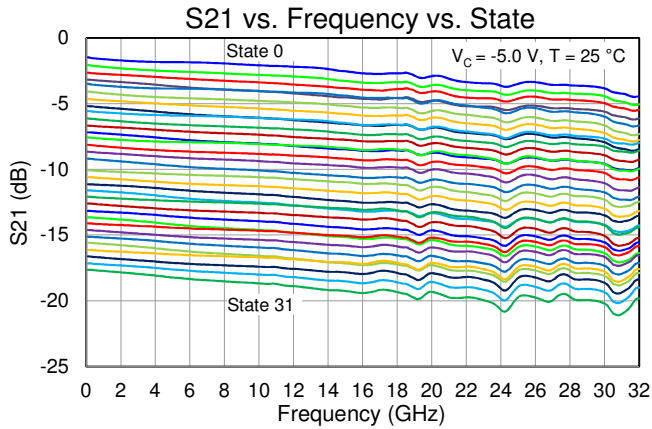

**Typical Performance**

Test conditions unless otherwise noted: Tested with DUT on EVB

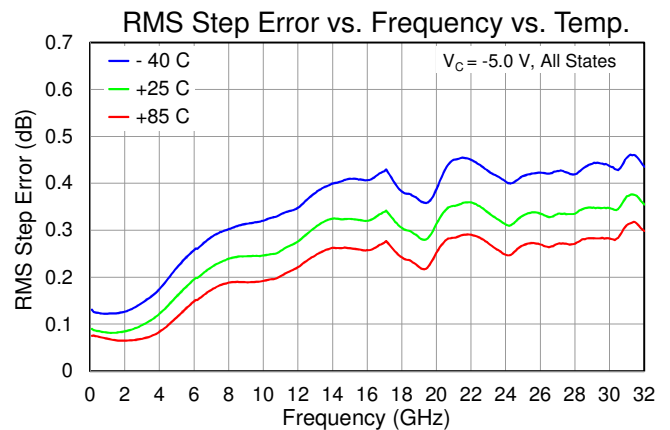
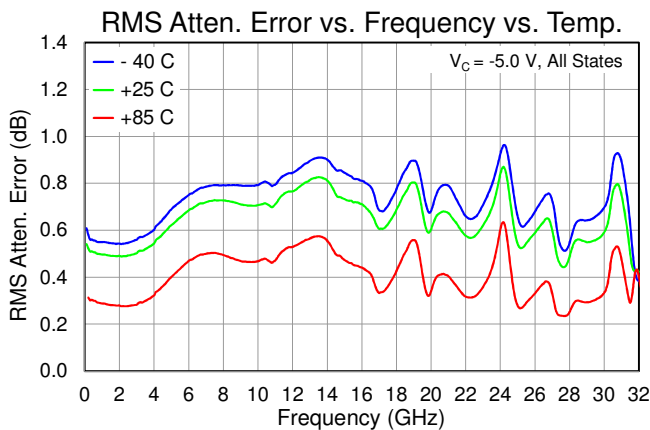
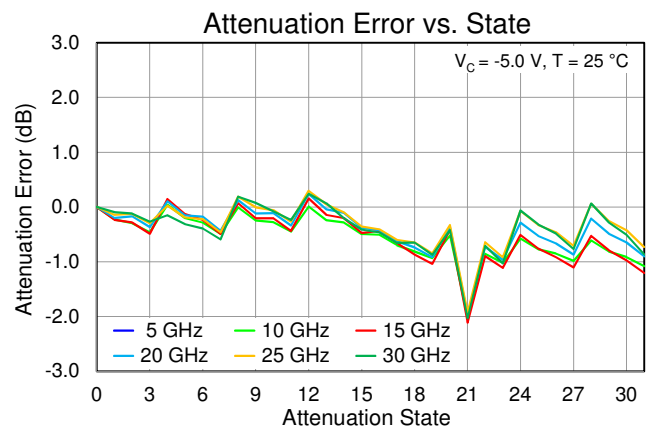
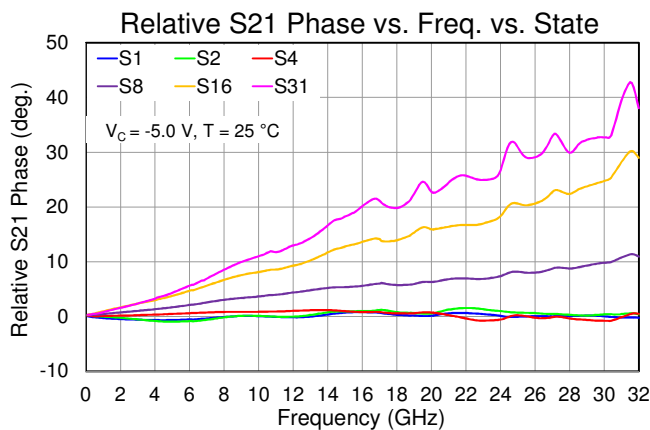
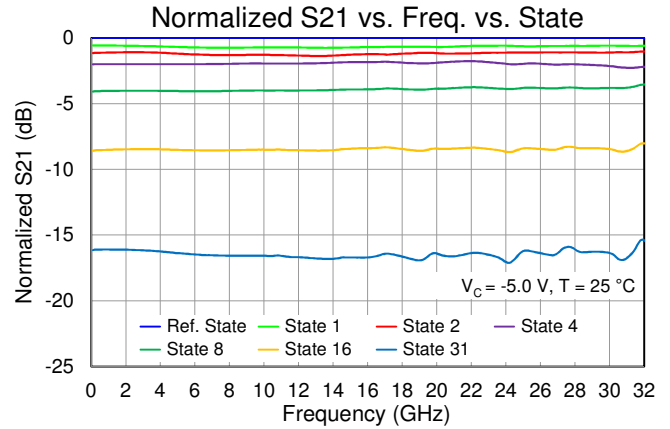
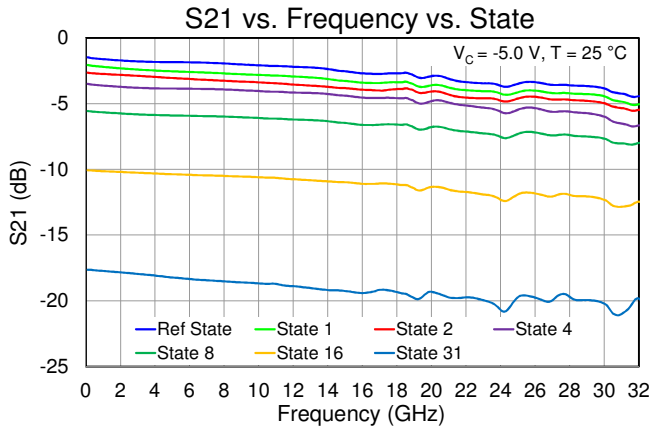

**Typical Performance**

Test conditions unless otherwise noted: Tested with DUT on EVB

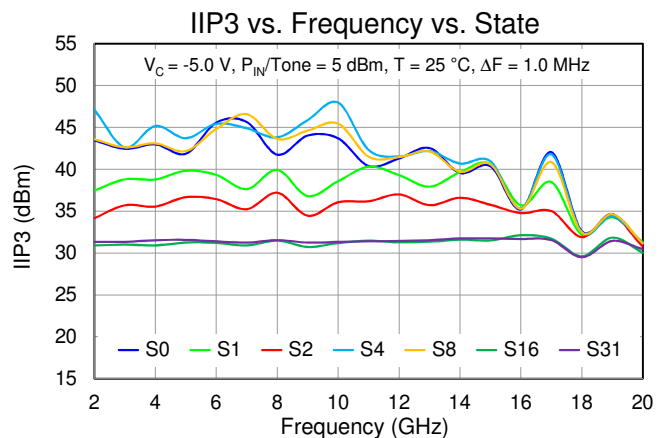
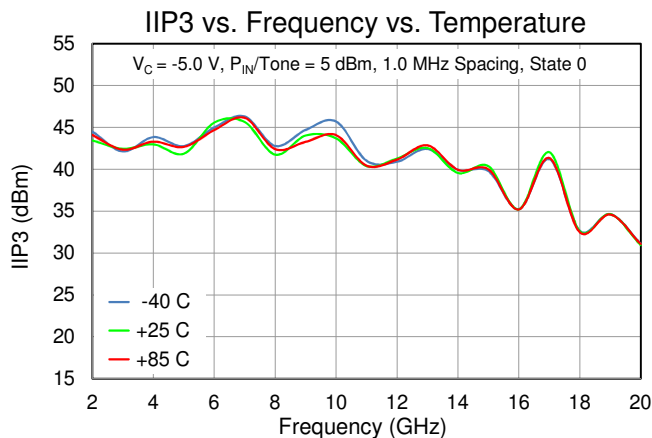
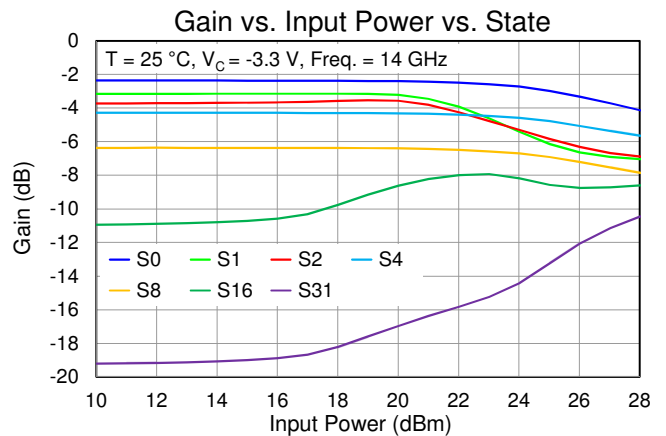
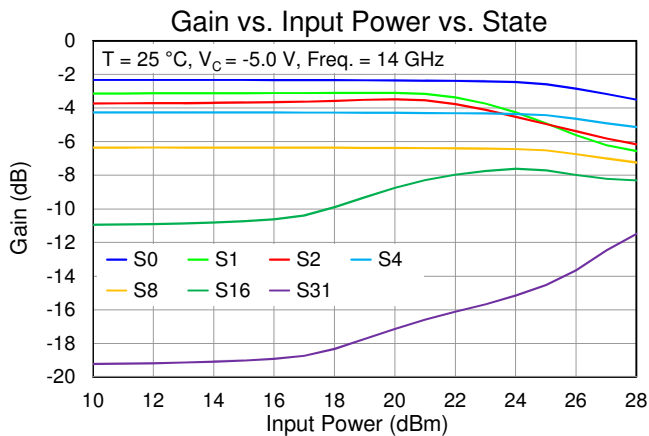
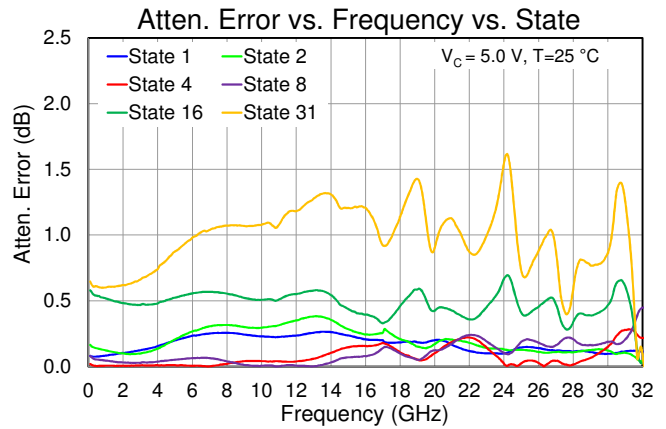
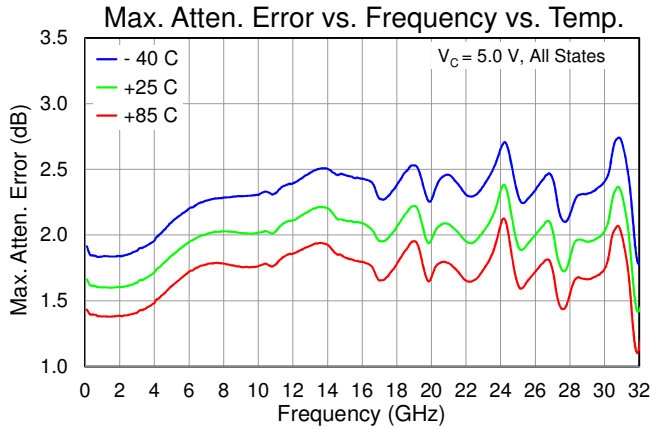

**Application Circuit**

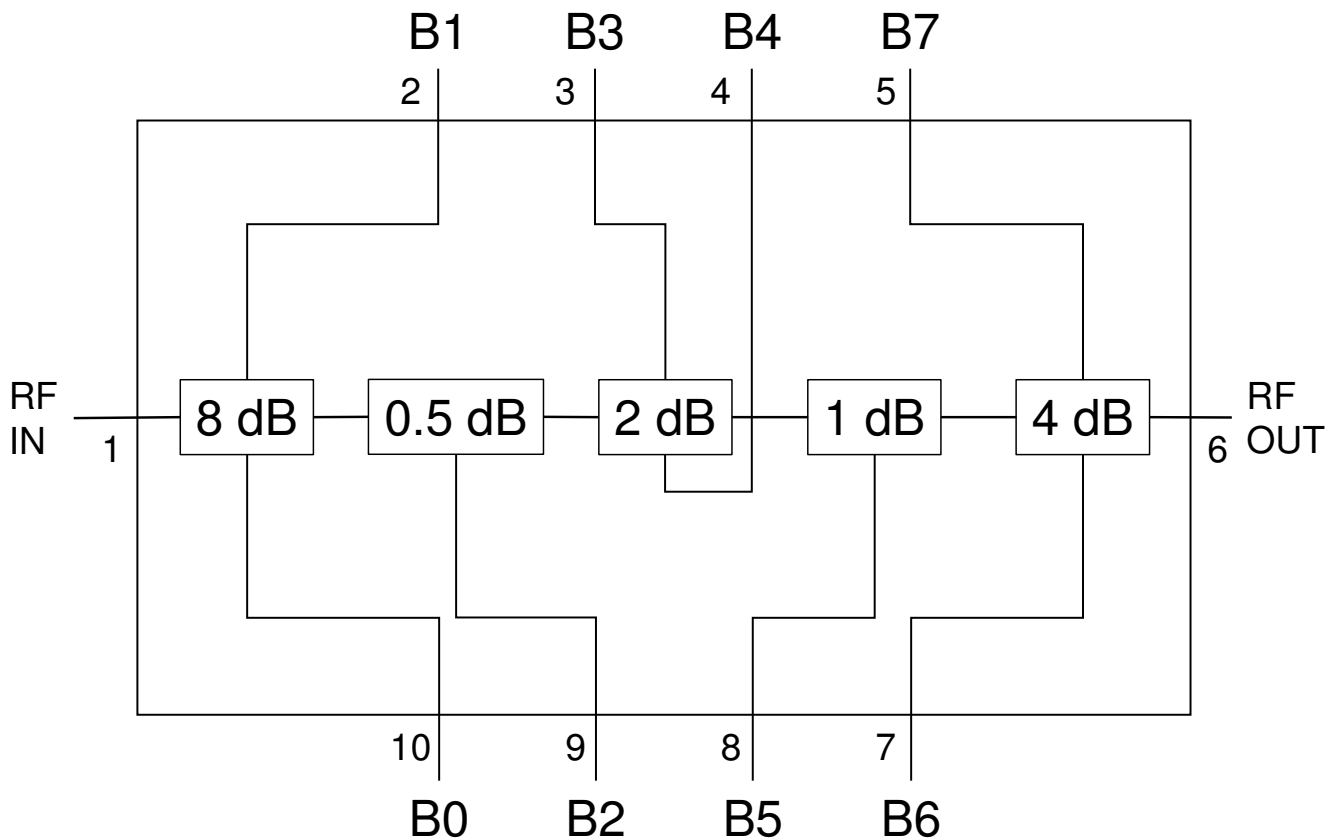

**Function Table – Major States**

Parameter	State	B0	B1	B2	B3	B4	B5	B6	B7
0.0 dB Attenuation (Ref. State)	State 0	1	0	0	0	1	0	1	0
0.5 dB Attenuation	State 1	1	0	1	0	1	0	1	0
1.0 dB Attenuation	State 2	1	0	0	0	1	1	1	0
2.0 dB Attenuation	State 4	1	0	0	1	0	0	1	0
4.0 dB Attenuation	State 8	1	0	0	0	1	0	0	1
8.0 dB Attenuation	State 16	0	1	0	0	1	0	1	0
15.5 dB Attenuation	State 31	0	1	1	1	0	1	0	1

Intermediate attenuation states are combinations of the above major states.

Logic H = 0V. Logic L = -3.3 to -5.0 V

Note: RF Input and RF Output are both DC coupled.

**Applications Information**

**Evaluation Board Layout**

RF Layer is 0.008" thick Rogers Corp. RO4003C,  $\epsilon_r = 3.38$ . Metal layers are 0.5 oz. copper. The microstrip line at the connector interface is optimized for the Southwest Microwave end launch connector 1092-01A-5.

The pad pattern shown has been developed and tested for optimized assembly at TriQuint Semiconductor. The PCB land pattern has been developed to accommodate lead and package tolerances. Since surface mount processes vary from company to company, careful process development is recommended.

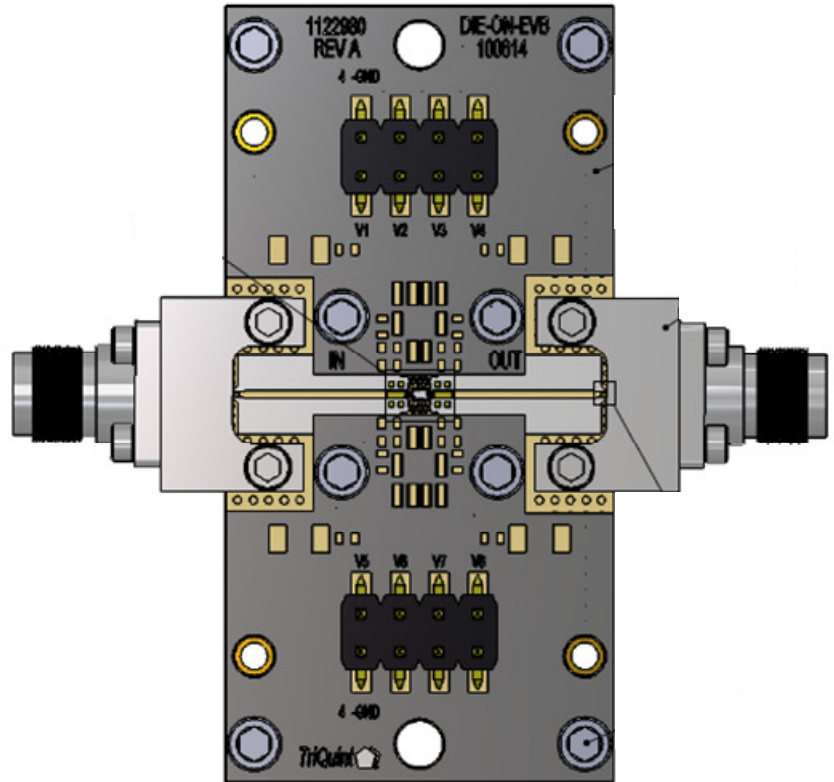

**EVB Die Mounting Detail**

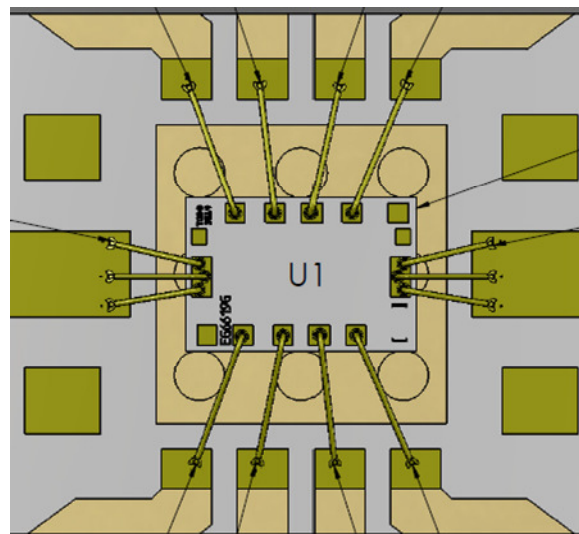

Note:  
Multiple vias should be employed under die to minimize inductance and thermal resistance.



**Mechanical Drawing and Bond Pad Description**

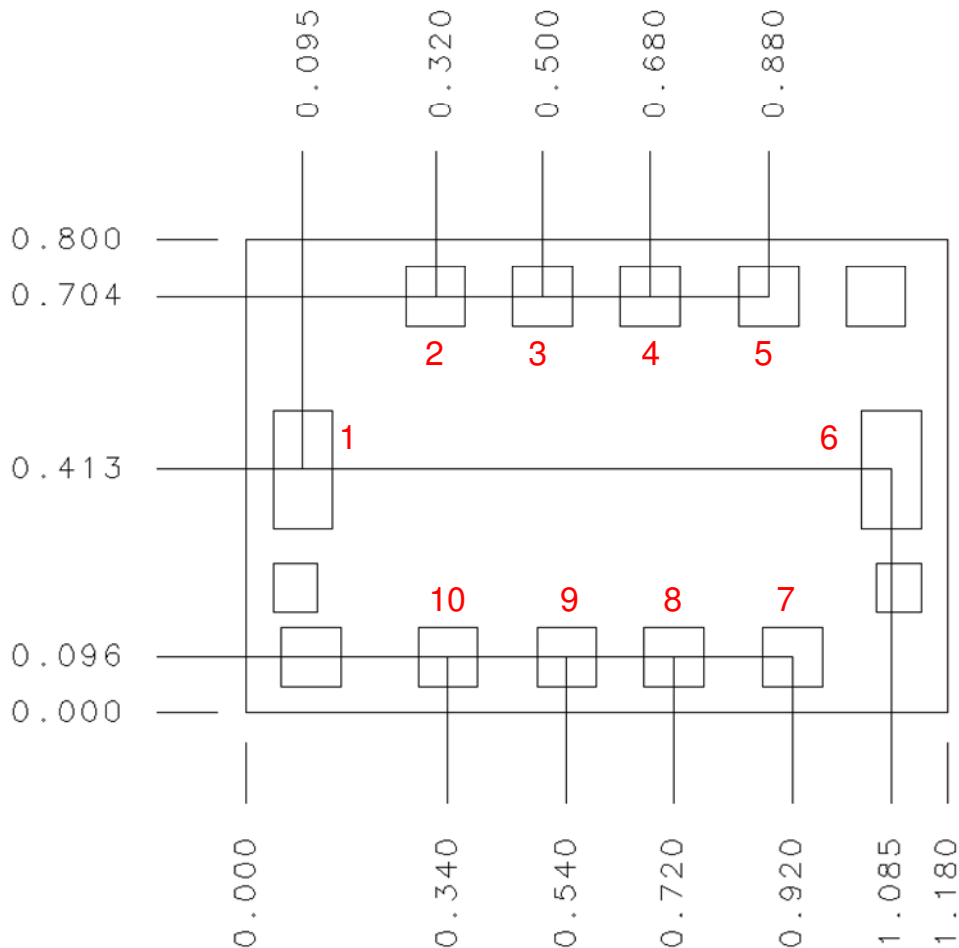

Pin No.	Symbol	Description	Pad Size (um x um)
1	RF Input	RF Input	100 x 200
2	B1	Complementary control line for 8.0 dB bit	100 x 100
3	B3	Complementary control line for 2.0 dB bit	100 x 100
4	B4	Complementary control line for 2.0 dB bit	100 x 100
5	B7	Complementary control line for 4.0 dB bit	100 x 100
6	RF Output	RF Output	100 x 200
7	B6	Complementary control line for 4.0 dB bit	100 x 100
8	B5	Control line for 1.0 dB bit	100 x 100
9	B2	Control line for 0.5 dB bit	100 x 100
10	B0	Complementary control line for 8.0 dB bit	100 x 100

## Assembly Notes

Component placement and adhesive attachment assembly notes:

- Vacuum pencils and/or vacuum collets are the preferred method of pick up.
- Air bridges must be avoided during placement.
- The force impact is critical during auto placement.
- Organic attachment (i.e., conductive epoxy) can be used in low-power applications.
- Curing should be done in a convection oven; proper exhaust is a safety concern.

Reflow process assembly notes:

- Use AuSn (80/20) solder and limit exposure to temperatures above 300°C to 3-4 minutes, maximum.
- An alloy station or conveyor furnace with reducing atmosphere should be used.
- Do not use any kind of flux.
- Coefficient of thermal expansion matching is critical for long-term reliability.
- Devices must be stored in a dry nitrogen atmosphere.

Interconnect process assembly notes:

- Thermosonic ball bonding is the preferred interconnect technique.
- Force, time, and ultrasonics are critical parameters.
- Aluminum wire should not be used.
- Devices with small pad sizes should be bonded with 0.0007-inch wire.

### Product Compliance Information

#### ESD Sensitivity Ratings



Caution! ESD-Sensitive Device

ESD Rating: TBD  
Value: TBD  
Test: Human Body Model (HBM)  
Standard: JEDEC Standard JESD22-A114

#### ECCN

US Department of Commerce: EAR99

#### Solderability

Use only AuSn (80/20) solder and limit exposure to temperatures above 300 °C to 3-4 minutes, maximum.

Conductive epoxy die attach is recommended for PCBs.

#### RoHS-Compliance

This part is compliant with EU 2002/95/EC RoHS directive (Restrictions on the Use of Certain Hazardous Substances in Electrical and Electronic Equipment).

This product also has the following attributes:

- Lead Free
- Halogen Free (Chlorine, Bromine)
- Antimony Free
- TBBP-A (C15H12Br4O2) Free
- PFOS Free
- SVHC Free

### Contact Information

For the latest specifications, additional product information, worldwide sales and distribution locations, and information about TriQuint:

Web: [www.triquint.com](http://www.triquint.com)  
Email: [info-sales@tqs.com](mailto:info-sales@tqs.com)

Tel: +1.972.994.8465  
Fax: +1.972.994.8504

For technical questions and application information: Email: [info-products@tqs.com](mailto:info-products@tqs.com)

### Important Notice

The information contained herein is believed to be reliable. TriQuint makes no warranties regarding the information contained herein. TriQuint assumes no responsibility or liability whatsoever for any of the information contained herein. TriQuint assumes no responsibility or liability whatsoever for the use of the information contained herein. The information contained herein is provided "AS IS, WHERE IS" and with all faults, and the entire risk associated with such information is entirely with the user. All information contained herein is subject to change without notice. Customers should obtain and verify the latest relevant information before placing orders for TriQuint products. The information contained herein or any use of such information does not grant, explicitly or implicitly, to any party any patent rights, licenses, or any other intellectual property rights, whether with regard to such information itself or anything described by such information.

TriQuint products are not warranted or authorized for use as critical components in medical, life-saving, or life-sustaining applications, or other applications where a failure would reasonably be expected to cause severe personal injury or death.



## Стандарт Электрон Связь

Мы молодая и активно развивающаяся компания в области поставок электронных компонентов. Мы поставляем электронные компоненты отечественного и импортного производства напрямую от производителей и с крупнейших складов мира.

Благодаря сотрудничеству с мировыми поставщиками мы осуществляем комплексные и плановые поставки широчайшего спектра электронных компонентов.

Собственная эффективная логистика и склад в обеспечивает надежную поставку продукции в точно указанные сроки по всей России.

Мы осуществляем техническую поддержку нашим клиентам и предпродажную проверку качества продукции. На все поставляемые продукты мы предоставляем гарантию .

Осуществляем поставки продукции под контролем ВП МО РФ на предприятия военно-промышленного комплекса России , а также работаем в рамках 275 ФЗ с открытием отдельных счетов в уполномоченном банке. Система менеджмента качества компании соответствует требованиям ГОСТ ISO 9001.

Минимальные сроки поставки, гибкие цены, неограниченный ассортимент и индивидуальный подход к клиентам являются основой для выстраивания долгосрочного и эффективного сотрудничества с предприятиями радиоэлектронной промышленности, предприятиями ВПК и научно-исследовательскими институтами России.

С нами вы становитесь еще успешнее!

### Наши контакты:

**Телефон:** +7 812 627 14 35

**Электронная почта:** [sales@st-electron.ru](mailto:sales@st-electron.ru)

**Адрес:** 198099, Санкт-Петербург,  
Промышленная ул, дом № 19, литера Н,  
помещение 100-Н Офис 331