

FEATURES

- Full 16-bit performance
- 3 V and 5 V single-supply operation
- Low 0.625 mW power dissipation
- 1 μ s settling time
- Unbuffered voltage output capable of driving 60 k Ω loads directly
- SPI-/QSPI-/MICROWIRE-compatible interface standards
- Power-on reset clears DAC output to 0 V (unipolar mode)
- 5 kV HBM ESD classification
- Low glitch: 1.1 nV-sec

APPLICATIONS

- Digital gain and offset adjustment
- Automatic test equipment
- Data acquisition systems
- Industrial process control

GENERAL DESCRIPTION

The AD5541/AD5542 are single, 16-bit, serial input, voltage output digital-to-analog converters (DACs) that operate from a single 2.7 V to 5.5 V supply. The DAC output range extends from 0 V to V_{REF} .

The DAC output range extends from 0 V to V_{REF} and is guaranteed monotonic, providing 1 LSB INL accuracy at 16 bits without adjustment over the full specified temperature range of -40°C to $+85^{\circ}\text{C}$. Offering unbuffered outputs, the AD5541/AD5542 achieve a 1 μ s settling time with low power consumption and low offset errors. Providing a low noise performance of 11.8 nV/ $\sqrt{\text{Hz}}$ and low glitch, the AD5541/AD5542 is suitable for deployment across multiple end systems.

The AD5542 can be operated in bipolar mode, which generates a $\pm V_{REF}$ output swing. The AD5542 also includes Kelvin sense connections for the reference and analog ground pins to reduce layout sensitivity.

The AD5541/AD5542 utilize a versatile 3-wire interface that is compatible with SPI, QSPI™, MICROWIRE™ and DSP interface standards. The AD5541/AD5542 are available in 8-lead and 14-lead SOIC packages.

Rev. F

Information furnished by Analog Devices is believed to be accurate and reliable. However, no responsibility is assumed by Analog Devices for its use, nor for any infringements of patents or other rights of third parties that may result from its use. Specifications subject to change without notice. No license is granted by implication or otherwise under any patent or patent rights of Analog Devices. Trademarks and registered trademarks are the property of their respective owners.

FUNCTIONAL BLOCK DIAGRAMS



Figure 1. AD5541



Figure 2. AD5542

Table 1.

Part No.	Description
AD5541A/AD5542A	Single, 16-bit unbuffered <i>nanoDAC</i> ™, ± 1 LSB INL, LFCSP
AD5024/AD5044/AD5064	Quad 12-/14-/16-bit <i>nanoDAC</i> , ± 1 LSB INL, TSSOP
AD5062	Single, 16-bit <i>nanoDAC</i> , ± 1 LSB INL, SOT-23
AD5063	Single, 16-bit <i>nanoDAC</i> , ± 1 LSB INL, SOT-23

PRODUCT HIGHLIGHTS

1. Single-Supply Operation. The AD5541 and AD5542 are fully specified and guaranteed for a single 2.7 V to 5.5 V supply.
2. Low Power Consumption. These parts consume typically 0.625 mW with a 5 V supply and 0.375 mW at 3 V.
3. 3-Wire Serial Interface.
4. Unbuffered Output Capable of Driving 60 k Ω Loads. This reduces power consumption because there is no internal buffer to drive.
5. Power-On Reset Circuitry.

TABLE OF CONTENTS

Features	1	Bipolar Output Operation.....	12
Applications.....	1	Output Amplifier Selection.....	12
General Description	1	Force Sense Amplifier Selection.....	12
Functional Block Diagrams.....	1	Reference and Ground.....	12
Product Highlights	1	Power-On Reset.....	13
Revision History	2	Power Supply and Reference Bypassing	13
Specifications.....	3	Microprocessor Interfacing.....	14
Timing Characteristics	4	AD5541/AD5542 to ADSP-21xx Interface.....	14
Absolute Maximum Ratings.....	5	AD5541/AD5542 to 68HC11/68L11 Interface.....	14
ESD Caution.....	5	AD5541/AD5542 to MICROWIRE Interface	14
Pin Configurations and Function Descriptions	6	AD5541/AD5542 to 80C51/80L51 Interface.....	14
Typical Performance Characteristics	7	Applications Information	15
Terminology	10	Optocoupler Interface.....	15
Theory of Operation	11	Decoding Multiple AD5541/AD5542s.....	15
Digital-to-Analog Section	11	Outline Dimensions	16
Serial Interface	11	Ordering Guide	17
Unipolar Output Operation	11		

REVISION HISTORY

3/12—Rev. E to Rev. F

Change to Figure 19	9
Changes to Ordering Guide	17

3/11—Rev. D to Rev. E

Changed +105°C to +85°C, General Description Section	1
--	---

2/11—Rev. C to Rev. D

Changes to Features Section, General Description Section, Product Highlights Section	1
Added Table 1; Renumbered Sequentially	1
Added Output Noise Spectral Density Parameter and Output Noise Parameter, Table 2.....	3
Changes to Ordering Guide	17

4/10—Rev. B to Rev. C

Changes to General Description Section	1
Changes to Features List	1

Changes to Product Highlights	1
Changes to Table 1	3
Changes to Table 3.....	5
Changes to Figure 16, Figure 17, and Figure 19.....	8, 9
Changes to Theory of Operations Section.....	11
Changes to Microprocessor Interfacing Section	14
Changes to Outline Dimensions	16
Changes to Ordering Guide	17

8/08—Rev. A to Rev. B

Updated Format.....	Universal
Changes to Timing Characteristics Section.....	4
Changes to Table 3.....	5
Updated Outline Dimensions.....	16
Changes to Ordering Guide	17

10/99—Rev. 0 to Rev. A

SPECIFICATIONS

$V_{DD} = 2.7\text{ V to }5.5\text{ V}$, $2.5\text{ V} \leq V_{REF} \leq V_{DD}$, $AGND = DGND = 0\text{ V}$. All specifications $T_A = T_{MIN}$ to T_{MAX} , unless otherwise noted.

Table 2.

Parameter ¹	Min	Typ	Max	Unit	Test Conditions
STATIC PERFORMANCE					
Resolution	16			Bits	
Relative Accuracy (INL)		±0.5	±1.0	LSB	L, C grades
		±0.5	±2.0	LSB	B, J grades
		±0.5	±4.0	LSB	A grade
Differential Nonlinearity (DNL)		±0.5	±1.0	LSB	Guaranteed monotonic
			±1.5	LSB	J grade
Gain Error		+0.5	±2	LSB	$T_A = 25^\circ\text{C}$
			±3	LSB	
Gain Error Temperature Coefficient		±0.1		ppm/°C	
Unipolar Zero Code Error		±0.3	±0.7	LSB	$T_A = 25^\circ\text{C}$
			±1.5	LSB	
Unipolar Zero Code Temperature Coefficient		±0.05		ppm/°C	
AD5542					
Bipolar Resistor Matching		1.000		Ω/Ω	R_{FB}/R_{INV} , typically $R_{FB} = R_{INV} = 28\text{ k}\Omega$
		±0.0015	±0.0076	%	Ratio error
Bipolar Zero Offset Error		±1	±5	LSB	$T_A = 25^\circ\text{C}$
			±6	LSB	
Bipolar Zero Temperature Coefficient		±0.2		ppm/°C	
Bipolar Zero Code Offset Error		±1	±5	LSB	$T_A = 25^\circ\text{C}$
			±6	LSB	
Bipolar Gain Error		+1	±5	LSB	$T_A = 25^\circ\text{C}$
			±6	LSB	
Bipolar Gain Temperature Coefficient		±0.1		ppm/°C	
OUTPUT CHARACTERISTICS					
Output Voltage Range	0		$V_{REF} - 1\text{ LSB}$	V	Unipolar operation
	$-V_{REF}$		$V_{REF} - 1\text{ LSB}$	V	AD5542 bipolar operation
Output Voltage Settling Time		1		μs	To 1/2 LSB of FS, $C_L = 10\text{ pF}$
Slew Rate		17		V/μs	$C_L = 10\text{ pF}$, measured from 0% to 63%
Digital-to-Analog Glitch Impulse		1.1		nV-sec	1 LSB change around the major carry
Digital Feedthrough		0.2		nV-sec	All 1s loaded to DAC, $V_{REF} = 2.5\text{ V}$
DAC Output Impedance		6.25		kΩ	Tolerance typically 20%
Output Noise Spectral Density		11.8		nV/√Hz	DAC code = 0x8400, frequency = 1 kHz
Output Noise		0.134		μV p-p	0.1 Hz to 10 Hz
Power Supply Rejection Ratio			±1.0	LSB	$\Delta V_{DD} \pm 10\%$
DAC REFERENCE INPUT					
Reference Input Range	2.0		V_{DD}	V	
Reference Input Resistance ²	9			kΩ	Unipolar operation
	7.5			kΩ	AD5542, bipolar operation
LOGIC INPUTS					
Input Current			±1	μA	
Input Low Voltage, V_{INL}			0.8	V	
Input High Voltage, V_{INH}	2.4			V	
Input Capacitance ³			10	pF	
Hysteresis Voltage ³		0.15		V	
REFERENCE³					
Reference -3 dB Bandwidth		2.2		MHz	All 1s loaded
Reference Feedthrough		1		mV p-p	All 0s loaded, $V_{REF} = 1\text{ V p-p}$ at 100 kHz
Signal-to-Noise Ratio		92		dB	
Reference Input Capacitance		26		pF	Code 0x0000
		26		pF	Code 0xFFFF

Parameter ¹	Min	Typ	Max	Unit	Test Conditions
POWER REQUIREMENTS					
V_{DD}	2.7		5.5	V	Digital inputs at rails
I_{DD}		125	150	μ A	
Power Dissipation		0.625	0.825	mW	

¹ Temperature ranges are as follows: A, B, C versions: -40°C to $+85^{\circ}\text{C}$; J, L versions: 0°C to 70°C .

² Reference input resistance is code-dependent, minimum at 0x8555.

³ Guaranteed by design, not subject to production test.

TIMING CHARACTERISTICS

$V_{DD} = 2.7\text{ V}$ to $5.5\text{ V} \pm 10\%$, $V_{REF} = 2.5\text{ V}$, $V_{INH} = 3\text{ V}$ and 90% of V_{DD} , $V_{INL} = 0\text{ V}$ and 10% of V_{DD} , $AGND = DGND = 0\text{ V}$; $-40^{\circ}\text{C} < T_A < +85^{\circ}\text{C}$, unless otherwise noted.

Table 3.

Parameter ^{1, 2}	Limit	Unit	Description
f_{SCLK}	25	MHz max	SCLK cycle frequency
t_1	40	ns min	SCLK cycle time
t_2	20	ns min	SCLK high time
t_3	20	ns min	SCLK low time
t_4	10	ns min	\overline{CS} low to SCLK high setup
t_5	15	ns min	\overline{CS} high to SCLK high setup
t_6	30	ns min	SCLK high to \overline{CS} low hold time
t_7	20	ns min	SCLK high to \overline{CS} high hold time
t_8	15	ns min	Data setup time
t_9	4	ns min	Data hold time ($V_{INH} = 90\%$ of V_{DD} , $V_{INL} = 10\%$ of V_{DD})
t_9	7.5	ns min	Data hold time ($V_{INH} = 3\text{ V}$, $V_{INL} = 0\text{ V}$)
t_{10}	30	ns min	\overline{LDAC} pulse width
t_{11}	30	ns min	\overline{CS} high to \overline{LDAC} low setup
t_{12}	30	ns min	\overline{CS} high time between active periods

¹ Guaranteed by design and characterization. Not production tested

² All input signals are specified with $t_r = t_f = 1\text{ ns/V}$ and timed from a voltage level of $(V_{INL} + V_{INH})/2$.



Figure 3. Timing Diagram

07857-003

ABSOLUTE MAXIMUM RATINGS

$T_A = 25^\circ\text{C}$, unless otherwise noted.

Table 4.

Parameter	Rating
V_{DD} to AGND	-0.3 V to +6 V
Digital Input Voltage to DGND	-0.3 V to $V_{DD} + 0.3$ V
V_{OUT} to AGND	-0.3 V to $V_{DD} + 0.3$ V
AGND, AGNDF, AGNDS to DGND	-0.3 V to +0.3 V
Input Current to Any Pin Except Supplies	± 10 mA
Operating Temperature Range	
Industrial (A, B, C Versions)	-40°C to $+85^\circ\text{C}$
Commercial (J, L Versions)	0°C to 70°C
Storage Temperature Range	-65°C to $+150^\circ\text{C}$
Maximum Junction Temperature (T_J max)	150°C
Package Power Dissipation	$(T_J \text{ max} - T_A)/\theta_{JA}$
Thermal Impedance, θ_{JA}	
SOIC (R-8)	$149.5^\circ\text{C}/\text{W}$
SOIC (R-14)	$104.5^\circ\text{C}/\text{W}$
Lead Temperature, Soldering	
Peak Temperature ¹	260°C
ESD ²	5 kV

¹ As per JEDEC Standard 20.

² HBM Classification

Stresses above those listed under Absolute Maximum Ratings may cause permanent damage to the device. This is a stress rating only; functional operation of the device at these or any other conditions above those indicated in the operational section of this specification is not implied. Exposure to absolute maximum rating conditions for extended periods may affect device reliability.

ESD CAUTION



ESD (electrostatic discharge) sensitive device.

Charged devices and circuit boards can discharge without detection. Although this product features patented or proprietary protection circuitry, damage may occur on devices subjected to high energy ESD. Therefore, proper ESD precautions should be taken to avoid performance degradation or loss of functionality.

PIN CONFIGURATIONS AND FUNCTION DESCRIPTIONS



Figure 4. AD5541 Pin Configuration

Table 5. AD5541 Pin Function Descriptions

Pin No.	Mnemonic	Description
1	V _{OUT}	Analog Output Voltage from the DAC.
2	AGND	Ground Reference Point for Analog Circuitry.
3	REF	Voltage Reference Input for the DAC. Connect to an external 2.5 V reference. Reference can range from 2 V to V _{DD} .
4	$\overline{\text{CS}}$	Logic Input Signal. The chip select signal is used to frame the serial data input.
5	SCLK	Clock Input. Data is clocked into the input register on the rising edge of SCLK. Duty cycle must be between 40% and 60%.
6	DIN	Serial Data Input. This device accepts 16-bit words. Data is clocked into the input register on the rising edge of SCLK.
7	DGND	Digital Ground. Ground reference for digital circuitry.
8	V _{DD}	Analog Supply Voltage, 5 V \pm 10%.



Figure 5. AD5542 Pin Configuration

Table 6. AD5542 Pin Function Descriptions

Pin No.	Mnemonic	Description
1	RFB	Feedback Resistor Pin. In bipolar mode, connect this pin to the external op amp output.
2	V _{OUT}	Analog Output Voltage from the DAC.
3	AGNDF	Ground Reference Point for Analog Circuitry (Force).
4	AGNDS	Ground Reference Point for Analog Circuitry (Sense).
5	REFS	Voltage Reference Input (Sense) for the DAC. Connect to an external 2.5 V reference. Reference can range from 2 V to V _{DD} .
6	REFF	Voltage Reference Input (Force) for the DAC. Connect to an external 2.5 V reference. Reference can range from 2 V to V _{DD} .
7	$\overline{\text{CS}}$	Logic Input Signal. The chip select signal is used to frame the serial data input.
8	SCLK	Clock Input. Data is clocked into the input register on the rising edge of SCLK. Duty cycle must be between 40% and 60%.
9	NC	No Connect.
10	DIN	Serial Data Input. This device accepts 16-bit words. Data is clocked into the input register on the rising edge of SCLK.
11	$\overline{\text{LDAC}}$	$\overline{\text{LDAC}}$ Input. When this input is taken low, the DAC register is simultaneously updated with the contents of the input register.
12	DGND	Digital Ground. Ground reference for digital circuitry.
13	INV	Connected to the Internal Scaling Resistors of the DAC. Connect the INV pin to external op amps inverting input in bipolar mode.
14	V _{DD}	Analog Supply Voltage, 5 V \pm 10%.

TYPICAL PERFORMANCE CHARACTERISTICS



Figure 6. Integral Nonlinearity vs. Code

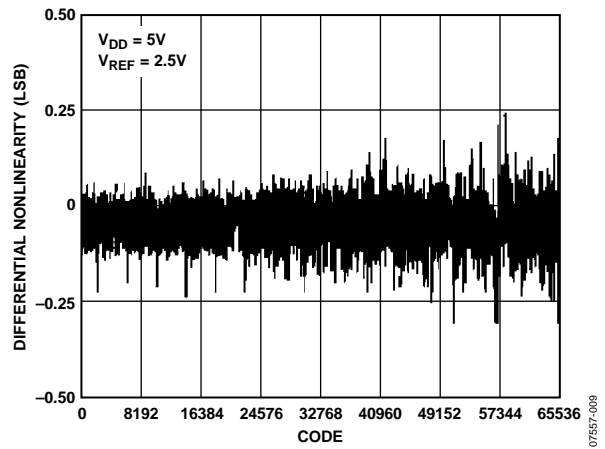

Figure 9. Differential Nonlinearity vs. Code

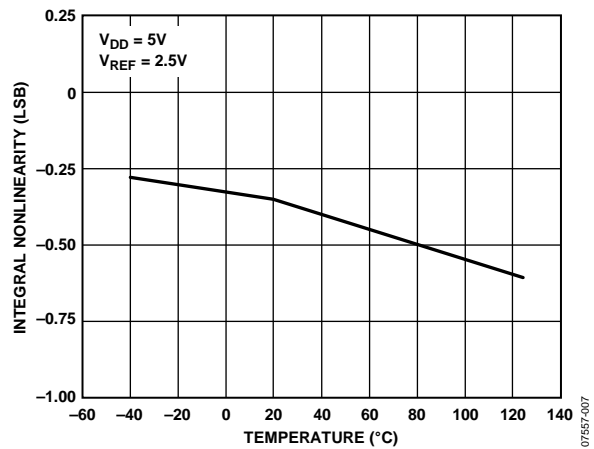

Figure 7. Integral Nonlinearity vs. Temperature

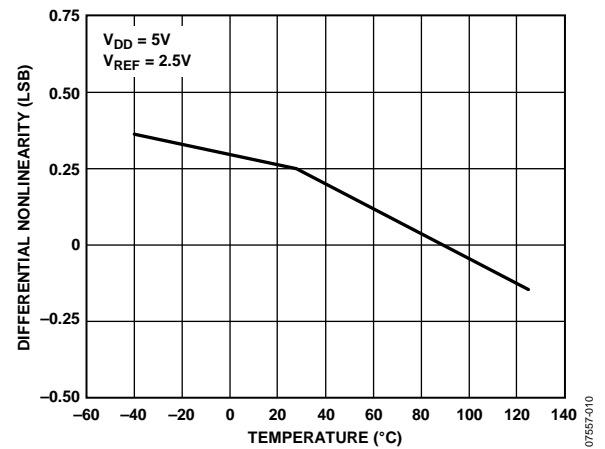

Figure 10. Differential Nonlinearity vs. Temperature

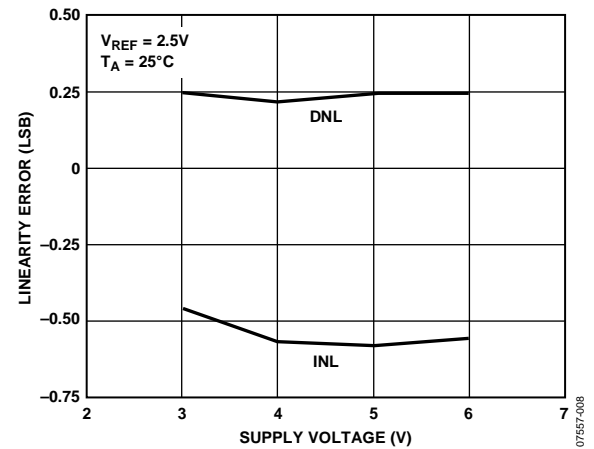

Figure 8. Linearity Error vs. Supply Voltage

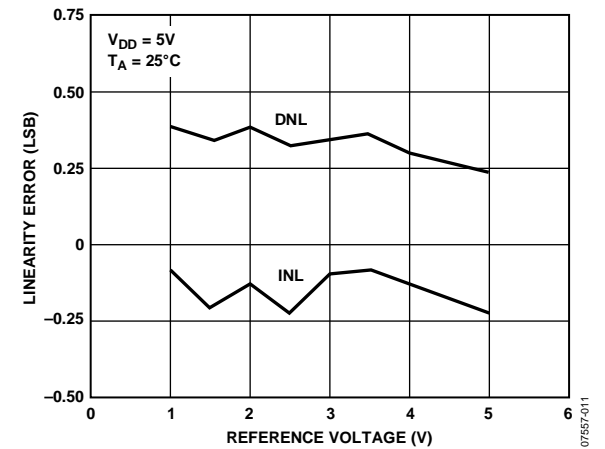

Figure 11. Linearity Error vs. Reference Voltage



Figure 12. Gain Error vs. Temperature



Figure 15. Zero-Code Error vs. Temperature



Figure 13. Supply Current vs. Temperature



Figure 16. Supply Current vs. Reference Voltage or Supply Voltage



Figure 14. Supply Current vs. Digital Input Voltage



Figure 17. Reference Current vs. Code



Figure 18. Digital Feedthrough

08898-018



Figure 20. Large Signal Settling Time

08898-020



Figure 19. Digital-to-Analog Glitch Impulse

07557-032



Figure 21. Small Signal Settling Time

07557-021

TERMINOLOGY

Relative Accuracy or Integral Nonlinearity (INL)

For the DAC, relative accuracy or INL is a measure of the maximum deviation, in LSBs, from a straight line passing through the endpoints of the DAC transfer function. A typical INL vs. code plot can be seen in Figure 6.

Differential Nonlinearity (DNL)

DNL is the difference between the measured change and the ideal 1 LSB change between any two adjacent codes. A specified differential nonlinearity of ± 1 LSB maximum ensures monotonicity. Figure 9 illustrates a typical DNL vs. code plot.

Gain Error

Gain error is the difference between the actual and ideal analog output range, expressed as a percent of the full-scale range. It is the deviation in slope of the DAC transfer characteristic from ideal.

Gain Error Temperature Coefficient

Gain error temperature coefficient is a measure of the change in gain error with changes in temperature. It is expressed in ppm/ $^{\circ}$ C.

Zero Code Error

Zero code error is a measure of the output error when zero code is loaded to the DAC register.

Zero Code Temperature Coefficient

This is a measure of the change in zero code error with a change in temperature. It is expressed in mV/ $^{\circ}$ C.

Digital-to-Analog Glitch Impulse

Digital-to-analog glitch impulse is the impulse injected into the analog output when the input code in the DAC register changes state. It is normally specified as the area of the glitch in nV-sec and is measured when the digital input code is changed by 1 LSB at the major carry transition. A plot of the digital-to-analog glitch impulse is shown in Figure 19.

Digital Feedthrough

Digital feedthrough is a measure of the impulse injected into the analog output of the DAC from the digital inputs of the DAC, but it is measured when the DAC output is not updated. \overline{CS} is held high while the CLK and DIN signals are toggled. It is specified in nV-sec and is measured with a full-scale code change on the data bus, that is, from all 0s to all 1s and vice versa. A typical plot of digital feedthrough is shown in Figure 18.

Power Supply Rejection Ratio (PSRR)

PSRR indicates how the output of the DAC is affected by changes in the power supply voltage. Power-supply rejection ratio is quoted in terms of percent change in output per percent change in V_{DD} for full-scale output of the DAC. V_{DD} is varied by $\pm 10\%$.

Reference Feedthrough

Reference feedthrough is a measure of the feedthrough from the V_{REF} input to the DAC output when the DAC is loaded with all 0s. A 100 kHz, 1 V p-p is applied to V_{REF} . Reference feedthrough is expressed in mV p-p.

THEORY OF OPERATION

The AD5541/AD5542 are single, 16-bit, serial input, voltage output DACs. They operate from a single supply ranging from 2.7 V to 5 V and consume typically 125 μ A with a supply of 5 V. Data is written to these devices in a 16-bit word format, via a 3- or 4-wire serial interface. To ensure a known power-up state, these parts are designed with a power-on reset function. In unipolar mode, the output is reset to 0 V; in bipolar mode, the AD5542 output is set to $-V_{REF}$. Kelvin sense connections for the reference and analog ground are included on the AD5542.

DIGITAL-TO-ANALOG SECTION

The DAC architecture consists of two matched DAC sections. A simplified circuit diagram is shown in Figure 22. The DAC architecture of the AD5541/AD5542 is segmented. The four MSBs of the 16-bit data-word are decoded to drive 15 switches, E1 to E15. Each switch connects one of 15 matched resistors to either AGND or V_{REF} . The remaining 12 bits of the data-word drive switches S0 to S11 of a 12-bit voltage mode R-2R ladder network.



Figure 22. DAC Architecture

With this type of DAC configuration, the output impedance is independent of code, while the input impedance seen by the reference is heavily code dependent. The output voltage is dependent on the reference voltage, as shown in the following equation:

$$V_{OUT} = \frac{V_{REF} \times D}{2^N}$$

where:

D is the decimal data-word loaded to the DAC register.

N is the resolution of the DAC.

For a reference of 2.5 V, the equation simplifies to the following:

$$V_{OUT} = \frac{2.5 \times D}{65,536}$$

This gives a V_{OUT} of 1.25 V with midscale loaded and 2.5 V with full-scale loaded to the DAC.

The LSB size is $V_{REF}/65,536$.

SERIAL INTERFACE

The AD5541/AD5542 are controlled by a versatile 3- or 4-wire serial interface that operates at clock rates up to 25 MHz and is compatible with SPI, QSPI, MICROWIRE, and DSP interface standards. The timing diagram is shown in Figure 3. Input data is framed by the chip select input, \overline{CS} . After a high-to-low transition on \overline{CS} , data is shifted synchronously and latched into the input register on the rising edge of the serial clock, SCLK. Data is loaded MSB first in 16-bit words. After 16 data bits have been loaded into the serial input register, a low-to-high transition on \overline{CS} transfers the contents of the shift register to the DAC. Data can be loaded to the part only while \overline{CS} is low.

The AD5542 has an \overline{LDAC} function that allows the DAC latch to be updated asynchronously by bringing \overline{LDAC} low after \overline{CS} goes high. \overline{LDAC} should be maintained high while data is written to the shift register. Alternatively, \overline{LDAC} can be tied permanently low to update the DAC synchronously. With \overline{LDAC} tied permanently low, the rising edge of \overline{CS} loads the data to the DAC.

UNIPOLAR OUTPUT OPERATION

These DACs are capable of driving unbuffered loads of 60 k Ω . Unbuffered operation results in low supply current, typically 300 μ A, and a low offset error. The AD5541 provides a unipolar output swing ranging from 0 V to V_{REF} . The AD5542 can be configured to output both unipolar and bipolar voltages. Figure 23 shows a typical unipolar output voltage circuit. The code table for this mode of operation is shown in Table 7.



Figure 23. Unipolar Output

Table 7. Unipolar Code Table

DAC Latch Contents		Analog Output
MSB	LSB	
1111 1111 1111 1111		$V_{REF} \times (65,535/65,536)$
1000 0000 0000 0000		$V_{REF} \times (32,768/65,536) = \frac{1}{2} V_{REF}$
0000 0000 0000 0001		$V_{REF} \times (1/65,536)$
0000 0000 0000 0000		0 V

Assuming a perfect reference, the unipolar worst-case output voltage can be calculated from the following equation:

$$V_{OUT-UNI} = \frac{D}{2^{16}} \times (V_{REF} + V_{GE}) + V_{ZSE} + INL$$

where:

$V_{OUT-UNI}$ is unipolar mode worst-case output.

D is code loaded to DAC.

V_{REF} is reference voltage applied to the part.

V_{GE} is gain error in volts.

V_{ZSE} is zero scale error in volts.

INL is integral nonlinearity in volts.

BIPOLAR OUTPUT OPERATION

With the aid of an external op amp, the AD5542 can be configured to provide a bipolar voltage output. A typical circuit of such operation is shown in Figure 24. The matched bipolar offset resistors, R_{FB} and R_{INV} , are connected to an external op amp to achieve this bipolar output swing, typically $R_{FB} = R_{INV} = 28\text{ k}\Omega$. Table 8 shows the transfer function for this output operating mode. Also provided on the AD5542 are a set of Kelvin connections to the analog ground inputs.



Figure 24. Bipolar Output (AD5542 Only)

Table 8. Bipolar Code Table

DAC Latch Contents		Analog Output
MSB	LSB	
1111 1111 1111 1111		$+V_{REF} \times (32,767/32,768)$
1000 0000 0000 0001		$+V_{REF} \times (1/32,768)$
1000 0000 0000 0000		0 V
0111 1111 1111 1111		$-V_{REF} \times (1/32,768)$
0000 0000 0000 0000		$-V_{REF} \times (32,768/32,768) = -V_{REF}$

Assuming a perfect reference, the worst-case bipolar output voltage can be calculated from the following equation:

$$V_{OUT-BIP} = \frac{[(V_{OUT-UNI} + V_{OS})(2 + RD) - V_{REF}(1 + RD)]}{1 + (2 + RD)/A}$$

where:

$V_{OUT-BIP}$ is the bipolar mode worst-case output.

$V_{OUT-UNI}$ is the unipolar mode worst-case output.

V_{OS} is the external op amp input offset voltage.

RD is the R_{FB} and R_{INV} resistor matching error.

A is the op amp open-loop gain.

OUTPUT AMPLIFIER SELECTION

For bipolar mode, a precision amplifier should be used and supplied from a dual power supply. This provides the $\pm V_{REF}$ output. In a single-supply application, selection of a suitable op amp may be more difficult as the output swing of the amplifier does not usually include the negative rail, in this case, AGND. This can result in some degradation of the specified performance unless the application does not use codes near zero.

The selected op amp needs to have a very low-offset voltage (the DAC LSB is $38\ \mu\text{V}$ with a 2.5 V reference) to eliminate the need for output offset trims. Input bias current should also be very low because the bias current, multiplied by the DAC output impedance (approximately $6\text{ k}\Omega$), adds to the zero code error. Rail-to-rail input and output performance is required. For fast settling, the slew rate of the op amp should not impede the settling time of the DAC. Output impedance of the DAC is constant and code-independent, but to minimize gain errors, the input impedance of the output amplifier should be as high as possible. The amplifier should also have a 3 dB bandwidth of 1 MHz or greater. The amplifier adds another time constant to the system, hence increasing the settling time of the output. A higher 3 dB amplifier bandwidth results in a shorter effective settling time of the combined DAC and amplifier.

FORCE SENSE AMPLIFIER SELECTION

Use single-supply, low-noise amplifiers. A low-output impedance at high frequencies is preferred because the amplifiers need to be able to handle dynamic currents of up to $\pm 20\text{ mA}$.

REFERENCE AND GROUND

Because the input impedance is code-dependent, the reference pin should be driven from a low impedance source. The AD5541/AD5542 operate with a voltage reference ranging from 2 V to V_{DD} . References below 2 V result in reduced accuracy. The full-scale output voltage of the DAC is determined by the reference. Table 7 and Table 8 outline the analog output voltage or particular digital codes. For optimum performance, Kelvin sense connections are provided on the AD5542.

If the application does not require separate force and sense lines, tie the lines close to the package to minimize voltage drops between the package leads and the internal die.

POWER-ON RESET

The AD5541/AD5542 have a power-on reset function to ensure that the output is at a known state on power-up. On power-up, the DAC register contains all 0s until the data is loaded from the serial register. However, the serial register is not cleared on power-up, so its contents are undefined. When loading data initially to the DAC, 16 bits or more should be loaded to prevent erroneous data appearing on the output. If more than 16 bits are loaded, the last 16 are kept, and if less than 16 bits are loaded, bits remain from the previous word. If the AD5541/AD5542 need to be interfaced with data shorter than 16 bits, the data should be padded with 0s at the LSBs.

POWER SUPPLY AND REFERENCE BYPASSING

For accurate high-resolution performance, it is recommended that the reference and supply pins be bypassed with a 10 μF tantalum capacitor in parallel with a 0.1 μF ceramic capacitor.

MICROPROCESSOR INTERFACING

Microprocessor interfacing to the AD5541/AD5542 is via a serial bus that uses standard protocol that is compatible with DSP processors and microcontrollers. The communications channel requires a 3- or 4-wire interface consisting of a clock signal, a data signal and a synchronization signal. The AD5541/AD5542 require a 16-bit data-word with data valid on the rising edge of SCLK. The DAC update can be done automatically when the data is clocked in or it can be done under control of the LDAC (AD5542 only).

AD5541/AD5542 TO ADSP-21XX INTERFACE

Figure 25 shows a serial interface between the AD5541/AD5542 and the ADSP-21xx. The ADSP-21xx should be set to operate in the SPORT transmit alternate framing mode. The ADSP-21xx are programmed through the SPORT control register and should be configured as follows: internal clock operation, active low framing, 16-bit word length. Transmission is initiated by writing a word to the Tx register after the SPORT has been enabled. As the data is clocked out on each rising edge of the serial clock, an inverter is required between the DSP and the DAC, because the AD5541/AD5542 clock data in on the falling edge of the SCLK.



*ADDITIONAL PINS OMITTED FOR CLARITY.
**AD5542 ONLY.

Figure 25. AD5541/AD5542 to ADSP-21xx Interface

AD5541/AD5542 TO 68HC11/68L11 INTERFACE

Figure 26 shows a serial interface between the AD5541/AD5542 and the 68HC11/68L11 microcontroller. SCK of the 68HC11/68L11 drives the SCLK of the DAC, and the MOSI output drives the serial data line serial DIN. The CS signal is driven from one of the port lines. The 68HC11/68L11 is configured for master mode: MSTR = 1, CPOL = 0, and CPHA = 0. Data appearing on the MOSI output is valid on the rising edge of SCK.



*ADDITIONAL PINS OMITTED FOR CLARITY.
**AD5542 ONLY.

Figure 26. AD5541/AD5542 to 68HC11/68L11 Interface

AD5541/AD5542 TO MICROWIRE INTERFACE

Figure 27 shows an interface between the AD5541/AD5542 and any MICROWIRE-compatible device. Serial data is shifted out on the falling edge of the serial clock and into the AD5541/AD5542 on the rising edge of the serial clock. No glue logic is required because the DAC clocks data into the input shift register on the rising edge.



*ADDITIONAL PINS OMITTED FOR CLARITY.

Figure 27. AD5541/AD5542 to MICROWIRE Interface

AD5541/AD5542 TO 80C51/80L51 INTERFACE

A serial interface between the AD5541/AD5542 and the 80C51/80L51 microcontroller is shown in Figure 28. TxD of the microcontroller drives the SCLK of the AD5541/AD5542, and RxD drives the serial data line of the DAC. P3.3 is a bit programmable pin on the serial port that is used to drive CS.

The 80C51/80L51 provide the LSB first, whereas the AD5541/AD5542 expects the MSB of the 16-bit word first. Care should be taken to ensure the transmit routine takes this into account.

When data is to be transmitted to the DAC, P3.3 is taken low. Data on RxD is valid on the falling edge of TxD, so the clock must be inverted as the DAC clocks data into the input shift register on the rising edge of the serial clock. The 80C51/80L51 transmit data in 8-bit bytes with only eight falling clock edges occurring in the transmit cycle. As the DAC requires a 16-bit word, P3.3 must be left low after the first eight bits are transferred, and brought high after the second byte is transferred. LDAC on the AD5542 can also be controlled by the 80C51/80L51 serial port output by using another bit programmable pin, P3.4.

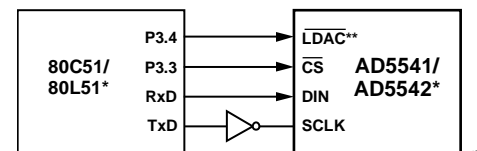

*ADDITIONAL PINS OMITTED FOR CLARITY.
**AD5542 ONLY.

Figure 28. AD5541/AD5542 to 80C51/80L51 Interface

APPLICATIONS INFORMATION

OPTOCOUPLER INTERFACE

The digital inputs of the AD5541/AD5542 are Schmitt-triggered so that they can accept slow transitions on the digital input lines. This makes these parts ideal for industrial applications where it may be necessary to isolate the DAC from the controller via optocouplers. Figure 29 illustrates such an interface.



Figure 29. AD5541/AD5542 in an Optocoupler Interface

07557-028

DECODING MULTIPLE AD5541/AD5542s

The \overline{CS} pin of the AD5541/AD5542 can be used to select one of a number of DACs. All devices receive the same serial clock and serial data, but only one device receives the \overline{CS} signal at any one time. The DAC addressed is determined by the decoder. There is some digital feedthrough from the digital input lines. Using a burst clock minimizes the effects of digital feedthrough on the analog signal channels. Figure 30 shows a typical circuit.

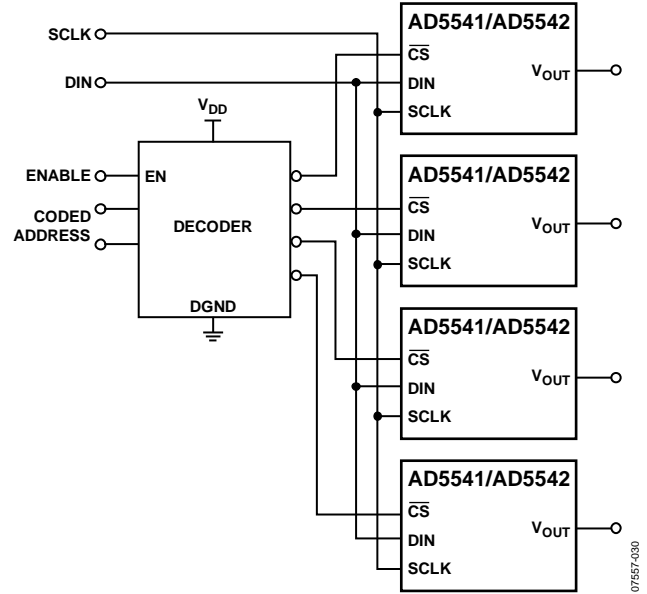

Figure 30. Addressing Multiple AD5541/AD5542s

07557-030

OUTLINE DIMENSIONS



COMPLIANT TO JEDEC STANDARDS MS-012-AA
 CONTROLLING DIMENSIONS ARE IN MILLIMETERS; INCH DIMENSIONS
 (IN PARENTHESES) ARE ROUNDED-OFF MILLIMETER EQUIVALENTS FOR
 REFERENCE ONLY AND ARE NOT APPROPRIATE FOR USE IN DESIGN.

012407-A

Figure 31. 8-Lead Standard Small Outline Package [SOIC_N]
 Narrow Body
 (R-8)

Dimensions shown in millimeters and (inches)



COMPLIANT TO JEDEC STANDARDS MS-012-AB
 CONTROLLING DIMENSIONS ARE IN MILLIMETERS; INCH DIMENSIONS
 (IN PARENTHESES) ARE ROUNDED-OFF MILLIMETER EQUIVALENTS FOR
 REFERENCE ONLY AND ARE NOT APPROPRIATE FOR USE IN DESIGN.

060606-A

Figure 32. 14-Lead Standard Small Outline Package [SOIC_N]
 Narrow Body
 (R-14)

Dimensions shown in millimeters and (inches)

ORDERING GUIDE

Model ¹	INL	DNL	Temperature Range	Package Description	Package Option
AD5541CR	±1 LSB	±1 LSB	−40°C to +85°C	8-Lead SOIC_N	R-8
AD5541CRZ	±1 LSB	±1 LSB	−40°C to +85°C	8-Lead SOIC_N	R-8
AD5541CRZ-REEL7	±1 LSB	±1 LSB	−40°C to +85°C	8-Lead SOIC_N	R-8
AD5541LR	±1 LSB	±1 LSB	0°C to 70°C	8-Lead SOIC_N	R-8
AD5541LR-REEL7	±1 LSB	±1 LSB	0°C to 70°C	8-Lead SOIC_N	R-8
AD5541LRZ	±1 LSB	±1 LSB	0°C to 70°C	8-Lead SOIC_N	R-8
AD5541LRZ-REEL7	±1 LSB	±1 LSB	0°C to 70°C	8-Lead SOIC_N	R-8
AD5541BR	±2 LSB	±1 LSB	−40°C to +85°C	8-Lead SOIC_N	R-8
AD5541BRZ	±2 LSB	±1 LSB	−40°C to +85°C	8-Lead SOIC_N	R-8
AD5541BRZ-REEL7	±2 LSB	±1 LSB	−40°C to +85°C	8-Lead SOIC_N	R-8
AD5541JR	±2 LSB	±1.5 LSB	0°C to 70°C	8-Lead SOIC_N	R-8
AD5541JR-REEL7	±2 LSB	±1.5 LSB	0°C to 70°C	8-Lead SOIC_N	R-8
AD5541JRZ	±2 LSB	±1.5 LSB	0°C to 70°C	8-Lead SOIC_N	R-8
AD5541JRZ-REEL7	±2 LSB	±1.5 LSB	0°C to 70°C	8-Lead SOIC_N	R-8
AD5541AR	±4 LSB	±1 LSB	−40°C to +85°C	8-Lead SOIC_N	R-8
AD5541AR-REEL7	±4 LSB	±1 LSB	−40°C to +85°C	8-Lead SOIC_N	R-8
AD5541ARZ	±4 LSB	±1 LSB	−40°C to +85°C	8-Lead SOIC_N	R-8
AD5541ARZ-REEL7	±4 LSB	±1 LSB	−40°C to +85°C	8-Lead SOIC_N	R-8
AD5542CR	±1 LSB	±1 LSB	−40°C to +85°C	14-Lead SOIC_N	R-14
AD5542CR-REEL7	±1 LSB	±1 LSB	−40°C to +85°C	14-Lead SOIC_N	R-14
AD5542CRZ	±1 LSB	±1 LSB	−40°C to +85°C	14-Lead SOIC_N	R-14
AD5542CRZ-REEL7	±1 LSB	±1 LSB	−40°C to +85°C	14-Lead SOIC_N	R-14
AD5542LR	±1 LSB	±1 LSB	0°C to 70°C	14-Lead SOIC_N	R-14
AD5542LRZ	±1 LSB	±1 LSB	0°C to 70°C	14-Lead SOIC_N	R-14
AD5542BR	±2 LSB	±1 LSB	−40°C to +85°C	14-Lead SOIC_N	R-14
AD5542BRZ	±2 LSB	±1 LSB	−40°C to +85°C	14-Lead SOIC_N	R-14
AD5542BRZ-REEL7	±2 LSB	±1 LSB	−40°C to +85°C	14-Lead SOIC_N	R-14
AD5542JR	±2 LSB	±1.5 LSB	0°C to 70°C	14-Lead SOIC_N	R-14
AD5542JR-REEL7	±2 LSB	±1.5 LSB	0°C to 70°C	14-Lead SOIC_N	R-14
AD5542JRZ	±2 LSB	±1.5 LSB	0°C to 70°C	14-Lead SOIC_N	R-14
AD5542JRZ-REEL7	±2 LSB	±1.5 LSB	0°C to 70°C	14-Lead SOIC_N	R-14
AD5542AR	±4 LSB	±1 LSB	−40°C to +85°C	14-Lead SOIC_N	R-14
AD5542AR-REEL7	±4 LSB	±1 LSB	−40°C to +85°C	14-Lead SOIC_N	R-14
AD5542ARZ	±4 LSB	±1 LSB	−40°C to +85°C	14-Lead SOIC_N	R-14
AD5542ARZ-REEL7	±4 LSB	±1 LSB	−40°C to +85°C	14-Lead SOIC_N	R-14
EVAL-AD5541/42EBZ				Evaluation Board	

¹ Z = RoHS Compliant Part.

NOTES

NOTES

NOTES



**Стандарт
Электрон
Связь**

Мы молодая и активно развивающаяся компания в области поставок электронных компонентов. Мы поставляем электронные компоненты отечественного и импортного производства напрямую от производителей и с крупнейших складов мира.

Благодаря сотрудничеству с мировыми поставщиками мы осуществляем комплексные и плановые поставки широчайшего спектра электронных компонентов.

Собственная эффективная логистика и склад в обеспечивает надежную поставку продукции в точно указанные сроки по всей России.

Мы осуществляем техническую поддержку нашим клиентам и предпродажную проверку качества продукции. На все поставляемые продукты мы предоставляем гарантию .

Осуществляем поставки продукции под контролем ВП МО РФ на предприятия военно-промышленного комплекса России , а также работаем в рамках 275 ФЗ с открытием отдельных счетов в уполномоченном банке. Система менеджмента качества компании соответствует требованиям ГОСТ ISO 9001.

Минимальные сроки поставки, гибкие цены, неограниченный ассортимент и индивидуальный подход к клиентам являются основой для выстраивания долгосрочного и эффективного сотрудничества с предприятиями радиоэлектронной промышленности, предприятиями ВПК и научно-исследовательскими институтами России.

С нами вы становитесь еще успешнее!

Наши контакты:

Телефон: +7 812 627 14 35

Электронная почта: sales@st-electron.ru

Адрес: 198099, Санкт-Петербург,
Промышленная ул, дом № 19, литера Н,
помещение 100-Н Офис 331