



Is Now Part of



**ON Semiconductor®**

To learn more about ON Semiconductor, please visit our website at  
[www.onsemi.com](http://www.onsemi.com)

Please note: As part of the Fairchild Semiconductor integration, some of the Fairchild orderable part numbers will need to change in order to meet ON Semiconductor's system requirements. Since the ON Semiconductor product management systems do not have the ability to manage part nomenclature that utilizes an underscore (\_), the underscore (\_) in the Fairchild part numbers will be changed to a dash (-). This document may contain device numbers with an underscore (\_). Please check the ON Semiconductor website to verify the updated device numbers. The most current and up-to-date ordering information can be found at [www.onsemi.com](http://www.onsemi.com). Please email any questions regarding the system integration to [Fairchild\\_questions@onsemi.com](mailto:Fairchild_questions@onsemi.com).

ON Semiconductor and the ON Semiconductor logo are trademarks of Semiconductor Components Industries, LLC dba ON Semiconductor or its subsidiaries in the United States and/or other countries. ON Semiconductor owns the rights to a number of patents, trademarks, copyrights, trade secrets, and other intellectual property. A listing of ON Semiconductor's product/patent coverage may be accessed at [www.onsemi.com/site/pdf/Patent-Marking.pdf](http://www.onsemi.com/site/pdf/Patent-Marking.pdf). ON Semiconductor reserves the right to make changes without further notice to any products herein. ON Semiconductor makes no warranty, representation or guarantee regarding the suitability of its products for any particular purpose, nor does ON Semiconductor assume any liability arising out of the application or use of any product or circuit, and specifically disclaims any and all liability, including without limitation special, consequential or incidental damages. Buyer is responsible for its products and applications using ON Semiconductor products, including compliance with all laws, regulations and safety requirements or standards, regardless of any support or applications information provided by ON Semiconductor. "Typical" parameters which may be provided in ON Semiconductor data sheets and/or specifications can and do vary in different applications and actual performance may vary over time. All operating parameters, including "Typicals" must be validated for each customer application by customer's technical experts. ON Semiconductor does not convey any license under its patent rights nor the rights of others. ON Semiconductor products are not designed, intended, or authorized for use as a critical component in life support systems or any FDA Class 3 medical devices or medical devices with a same or similar classification in a foreign jurisdiction or any devices intended for implantation in the human body. Should Buyer purchase or use ON Semiconductor products for any such unintended or unauthorized application, Buyer shall indemnify and hold ON Semiconductor and its officers, employees, subsidiaries, affiliates, and distributors harmless against all claims, costs, damages, and expenses, and reasonable attorney fees arising out of, directly or indirectly, any claim of personal injury or death associated with such unintended or unauthorized use, even if such claim alleges that ON Semiconductor was negligent regarding the design or manufacture of the part. ON Semiconductor is an Equal Opportunity/Affirmative Action Employer. This literature is subject to all applicable copyright laws and is not for resale in any manner.

# FSA644 — 2:1 MIPI D-PHY (1.5Gbps) 4-Data Lane Switch

## Features

Switch Type	SPDT (10x)
<b>Signal Types</b>	<b>MIPI, D-PHY</b>
V <sub>CC</sub>	1.65 to 4.5 V
Input Signals	0 to V <sub>CC</sub>
R <sub>ON</sub>	6 Ω Typical HS MIPI 8 Ω Typical LP MIPI
ΔR <sub>ON</sub>	0.6 Ω Typical HS & LP MIPI
R <sub>ON_FLAT</sub>	0.3 Ω Typical
I <sub>CCZ</sub>	0.5 μA Maximum
I <sub>CC</sub>	32 μA Maximum
O <sub>IRR</sub>	-40 dB Typical
X <sub>TALK</sub>	-25 dB Typical
Bandwidth	1100 MHz Minimum
Channel-to-Channel Skew	6 ps Typical
C <sub>ON</sub>	5.2 pF
Operating Temperature	-40 to +85°C
Package	36-Ball WLCSP
FSA644UCX Top Mark	M7
Ordering Information	FSA644UCX
FSA644BUCX Top Mark	KM
Ordering Information	FSA644BUCX

## Description

The FSA644 is a four-data-lane, MIPI, D-PHY switch. This single-pole, double-throw (SPDT) switch is optimized for switching between two high-speed or low-power MIPI sources. The FSA644 is designed for the MIPI specification and allows connection to a CSI or DSI module.

## Applications

- Cellular Phones, Smart Phones
- Displays

## Related Resources

- FSA644 Demonstration Board

## Typical Application

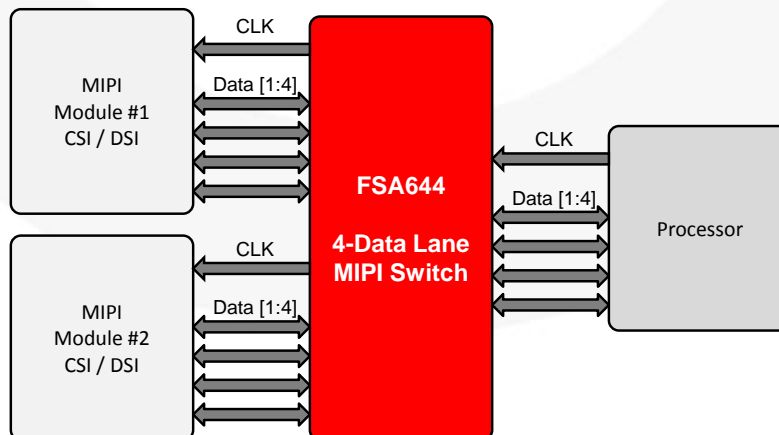

Figure 1. Mobile Phone Example

### Pin Descriptions

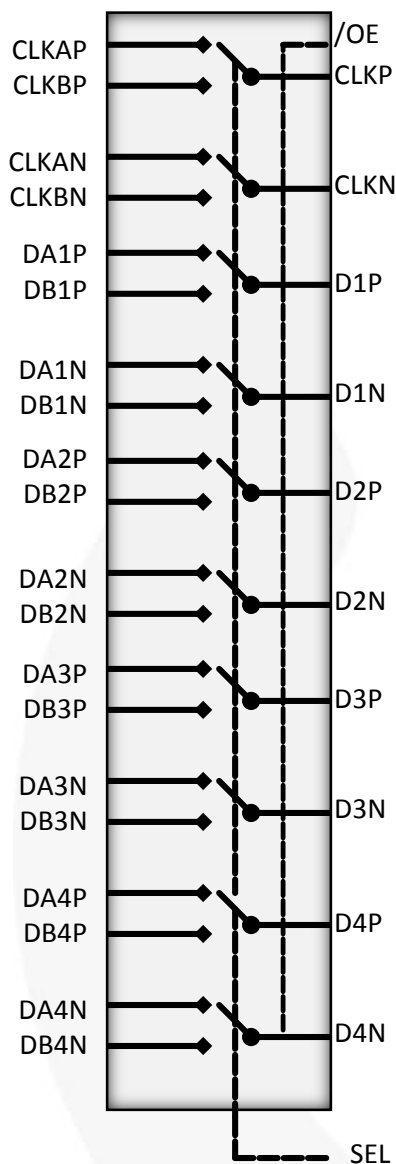

Figure 2. Analog Symbol

Pin Name	Description		
CLK <sub>P/N</sub>	Common Clock Path		
D1 <sub>P/N</sub>	Common Data Path 1		
D2 <sub>P/N</sub>	Common Data Path 2		
D3 <sub>P/N</sub>	Common Data Path 3		
D4 <sub>P/N</sub>	Common Data Path 4		
CLKA <sub>P/N</sub>	A-Side Clock Path		
DA1 <sub>P/N</sub>	A-Side Data Path 1		
DA2 <sub>P/N</sub>	A-Side Data Path 2		
DA3 <sub>P/N</sub>	A-Side Data Path 3		
DA4 <sub>P/N</sub>	A-Side Data Path 4		
CLKB <sub>P/N</sub>	B-Side Clock Path		
DB1 <sub>P/N</sub>	B-Side Data Path 1		
DB2 <sub>P/N</sub>	B-Side Data Path 2		
DB3 <sub>P/N</sub>	B-Side Data Path 3		
DB4 <sub>P/N</sub>	B-Side Data Path 4		
SEL	Control Pin	SEL=0	CLKP=CLKAP, CLKN=CLKAN, Dn(P/N)=DAn(P/N)
		SEL=1	CLKP=CLKBP, CLKN=CLKBN, Dn(P/N)=DBn(P/N)
/OE	Output Enable		
V <sub>CC</sub>	Power		
GND	Ground		
NC	No Connect		

## Pin Definitions

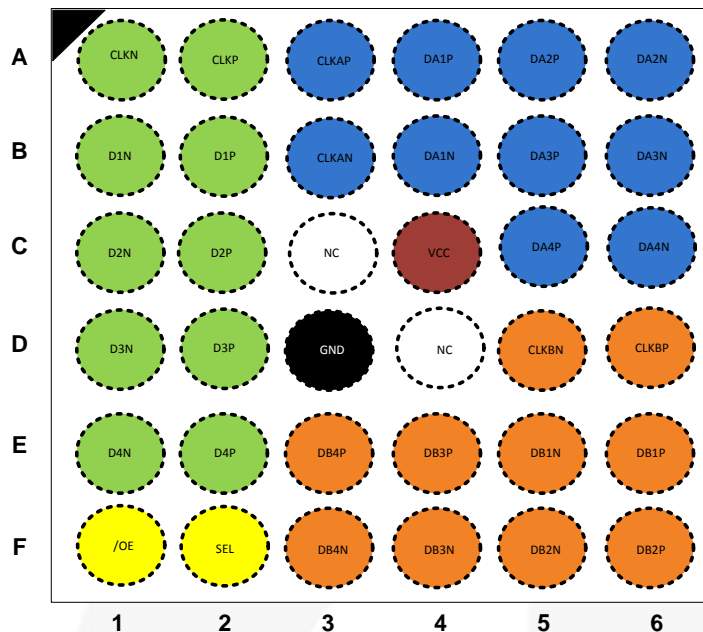

Figure 3. Top Through View

Table 1. Ball-to-Pin Mappings

Ball	Pin Name
A1	CLK <sub>N</sub>
A2	CLK <sub>P</sub>
A3	CLKA <sub>P</sub>
A4	DA1 <sub>P</sub>
A5	DA2 <sub>P</sub>
A6	DA2 <sub>N</sub>
B1	D1 <sub>N</sub>
B2	D1 <sub>P</sub>
B3	CLKA <sub>N</sub>
B4	DA1 <sub>N</sub>
B5	DA3 <sub>P</sub>
B6	DA3 <sub>N</sub>
C1	D2 <sub>N</sub>
C2	D2 <sub>P</sub>
C3	NC
C4	V <sub>CC</sub>
C5	DA4 <sub>P</sub>
C6	DA4 <sub>N</sub>
D1	D3 <sub>N</sub>
D2	D3 <sub>P</sub>
D3	GND
D4	NC
D5	CLKB <sub>N</sub>
D6	CLKB <sub>P</sub>
E1	D4 <sub>N</sub>
E2	D4 <sub>P</sub>
E3	DB4 <sub>P</sub>
E4	DB3 <sub>P</sub>
E5	DB1 <sub>N</sub>
E6	DB1 <sub>P</sub>
F1	/OE
F2	SEL
F3	DB4 <sub>N</sub>
F4	DB3 <sub>N</sub>
F5	DB2 <sub>N</sub>
F6	DB2 <sub>P</sub>

## Truth Table

SEL	/OE	Function
LOW	LOW	CLK <sub>P</sub> =CLKA <sub>P</sub> , CLK <sub>N</sub> =CLKA <sub>N</sub> , Dn(P/N)=DAn(P/N)
HIGH	LOW	CLK <sub>P</sub> =CLKB <sub>P</sub> , CLK <sub>N</sub> =CLKB <sub>N</sub> , Dn(P/N)=DBn(P/N)
X	HIGH	DAn(P/N), DBn(P/N) Data Ports High Impedance

## Absolute Maximum Ratings

Stresses exceeding the absolute maximum ratings may damage the device. The device may not function or be operable above the recommended operating conditions and stressing the parts to these levels is not recommended. In addition, extended exposure to stresses above the recommended operating conditions may affect device reliability. The absolute maximum ratings are stress ratings only.

Symbol	Parameter	Min.	Max.	Unit	
V <sub>CC</sub>	Supply Voltage	-0.50	+5.25	V	
V <sub>CNTRL</sub>	DC Input Voltage (/OE) <sup>(1)</sup>	-0.5	V <sub>CC</sub>	V	
V <sub>SW</sub>	DC Switch I/O Voltage <sup>(1)</sup>	-0.50	5.25	V	
I <sub>IK</sub>	DC Input Diode Current	-50		mA	
I <sub>OUT</sub>	DC Output Current		50	mA	
T <sub>STG</sub>	Storage Temperature	-65	+150	°C	
ESD	Human Body Model, JEDEC: JESD22-A114	All Pins		3.5	kV
		I/O to GND		3.5	
		Power to GND		8.0	
	Charged Device Model, JEDEC: JESD22-C101			1.5	
	IEC 61000-4-2 System	Contact		8.0	
		Air Gap		15.0	

### Note:

- The input and output negative ratings may be exceeded if the input and output diode current ratings are observed.

## Recommended Operating Conditions

The Recommended Operating Conditions table defines the conditions for actual device operation. Recommended operating conditions are specified to ensure optimal performance to the datasheet specifications. Fairchild does not recommend exceeding them or designing to Absolute Maximum Ratings.

Symbol	Parameter	Min.	Max.	Unit	
V <sub>CC</sub>	Supply Voltage	1.65	4.50	V	
V <sub>CNTRL</sub>	Control Input Voltage (S, /OE) <sup>(2)</sup>	0	V <sub>CC</sub>	V	
V <sub>SW</sub>	Switch I/O Voltage (CLKn, CLKAn, CLKBn, Dn, DAn, DBn)	HS Mode	0.1	0.3	V
		LP Mode	0	1.2	
T <sub>A</sub>	Operating Temperature	-40	+85	°C	

### Note:

- The control input must be held HIGH or LOW; it must not float.

## DC Electrical Characteristics

All typical values are at  $T_A=25^\circ\text{C}$  unless otherwise specified.

Symbol	Parameter	Conditions	$V_{CC}$ (V)	$T_A=-40^\circ\text{C}$ to $+85^\circ\text{C}$			Unit
				Min.	Typ.	Max.	
$V_{IK}$	Clamp Diode Voltage	$I_{IN}=-18\text{ mA}$	2.8			-1.2	V
$V_{IH}$	Input Voltage High		1.65 to 4.50	1.0			V
$V_{IL}$	Input Voltage Low		1.65 to 4.50			0.4	V
$I_{IN}$	Control Input Leakage (SEL,/OE)	$V_{SW}=0$ to $V_{CC}$	1.65 to 4.50	-100		100	nA
$I_{NO(OFF)}, I_{NC(OFF)}$	Off Leakage Current of Port CLKAn, DAN, CLKBn, DBn	CLKn, Dn=0.3 V; $V_{CC}=0.3\text{ V}$ ; CLKAn, DAN, or CLKBn; DBn= $V_{CC}-0.3\text{ V}$ , 0.3 V, or Floating; /OE=0 V	1.65 to 4.50	-100		100	nA
$I_{A(ON)}$	On Leakage Current of Common Ports (CLKn, Dn)	CLKn, Dn = 0.3 V; $V_{CC}=0.3\text{ V}$ ; CLKAn, DAN, or CLKBn; DBn= $V_{CC}-0.3\text{ V}$ , 0.3 V, or Floating; /OE=0 V	1.65 to 4.50	-100		100	nA
$I_{OFF}$	Power-Off Leakage Current	CLKn, Dn, or CLKAn; DAN or CLKBn, DBn; $V_{IN}=0\text{ V}$ to 4.5 V; $V_{CC}=0\text{ V}$	0	-100		100	nA
$I_{OZ}$	Off-State Leakage	$0 \leq \text{CLKn, Dn, CLKAn, CLKBn, DAN, DBn} \leq 3.6\text{ V}$ , /OE=High	4.5	-100		100	nA
$R_{ON\_MIPI\_HS}$	Switch On Resistance for HS MIPI Applications <sup>(3)</sup>	$I_{ON}=-10\text{ mA}$ , /OE=0 V, SEL= $V_{CC}$ or 0V, CLK <sub>A, B</sub> , DBn or DAN=0.1, 0.2, 0.3	1.8		7	12	$\Omega$
			2.5		6	9	
			3.6		6	9	
			4.5		6	9	
$R_{ON\_MIPI\_LP}$	Switch On Resistance for LP MIPI Applications <sup>(3)</sup>	$I_{ON}=-10\text{ mA}$ , /OE=0 V, SEL= $V_{CC}$ or 0V, CLK <sub>A, B</sub> , DBn or DAN=0, 0.6, 1.2 V	1.8		6.7	12.0	$\Omega$
			2.5		6.4	9.0	
			3.6		6.2	9.0	
			4.5		6.0	9.0	
$\Delta R_{ON\_MIPI\_HS}$	On Resistance Matching Between HS MIPI Channels <sup>(4)</sup>	$I_{ON}=-10\text{ mA}$ , /OE=0 V, SEL= $V_{CC}$ or 0 V, CLK <sub>A, B</sub> , DBn or DAN=0.1, 0.2, 0.3	1.8		0.8		$\Omega$
			2.5		0.6		
			3.6		0.5		
			4.5		0.5		
$\Delta R_{ON\_MIPI\_LP}$	On Resistance Matching Between LP MIPI Channels <sup>(4)</sup>	$I_{ON}=-10\text{ mA}$ , /OE=0 V, SEL= $V_{CC}$ or 0 V, CLK <sub>A, B</sub> , DBn or DAN= 0.0, 0.6, 1.2 V	1.8		0.8		$\Omega$
			2.5		0.6		
			3.6		0.5		
			4.5		0.5		
$R_{ON\_FLAT\_MIPI\_HS}$	On Resistance Flatness for HS MIPI Signals <sup>(4)</sup>	$I_{ON}=-10\text{ mA}$ , /OE=0 V, SEL= $V_{CC}$ or 0 V, CLK <sub>A, B</sub> , DBn or DAN=0.1, 0.2, 0.3	1.8		1.5		$\Omega$
			2.5		0.5		
			3.6		0.3		
			4.5		0.2		
$R_{ON\_FLAT\_MIPI\_LP}$	On Resistance Flatness for LP MIPI Signals <sup>(4)</sup>	$I_{ON}=-10\text{ mA}$ , /OE=0 V, SEL= $V_{CC}$ or 0 V, CLK <sub>A, B</sub> , DBn or DAN=0.0, 0.6, 1.2 V	1.8		35		$\Omega$
			2.5		2		
			3.6		1		
			4.5		0.5		

Continued on the following page...

## DC Electrical Characteristics

All typical values are at  $T_A=25^\circ\text{C}$  unless otherwise specified.

Symbol	Parameter	Conditions	$V_{CC}$ (V)	$T_A=-40^\circ\text{C}$ to $+85^\circ\text{C}$			Unit
				Min.	Typ.	Max.	
$I_{CCZ}$	Quiescent Hi-Z Supply Current	$V_{IN}=0$ or $V_{CC}$ , $I_{OUT}=0$	4.5			0.5	$\mu\text{A}$
$I_{CC}$	Quiescent Supply Current	$V_{IN}=0$ or $V_{CC}$ , $I_{OUT}=0$	2.5 to 4.5			32	$\mu\text{A}$
			1.8			22	
$I_{CCT}$	Increase in $I_{CC}$ Current Per Control Voltage and $V_{CC}$	$V_{SEL}/OE=1.65\text{ V}$	4.5			4	$\mu\text{A}$
			2.5			0.1	

### Notes:

- Measured by the voltage drop between A and B pins at the indicated current through the switch. On resistance is determined by the lower of the voltage on the two (A or B ports).
- Guaranteed by characterization.

## AC Electrical Characteristics

All typical values are for  $V_{CC}=3.3\text{V}$  at  $T_A=25^\circ\text{C}$  unless otherwise specified.

Symbol	Parameter	Conditions	$V_{CC}$ (V)	$T_A=-40^\circ\text{C}$ to $+85^\circ\text{C}$			Unit
				Min.	Typ.	Max.	
$t_{INIT}$	Initialization Time $V_{CC}$ to Output <sup>(5)</sup>	$R_L=50\ \Omega$ , $C_L=5\ \text{pF}$ , $V_{SW}=1.2\ \text{V}$	2.5 to 4.5			100	$\mu\text{s}$
			1.8			150	
$t_{EN}$	Enable Turn-On Time, /OE to Output	$R_L=50\ \Omega$ , $C_L=5\ \text{pF}$ , $V_{SW}=1.2\ \text{V}$	2.5 to 4.5		120	200	ns
			1.8		250	500	
$t_{DIS}$	Disable Turn-Off Time, /OE to Output	$R_L=50\ \Omega$ , $C_L=5\ \text{pF}$ , $V_{SW}=1.2\ \text{V}$	2.5 to 4.5		25	50	ns
			1.8		50	90	
$t_{ON}$	Turn-On Time, SEL to Output	$R_L=50\ \Omega$ , $C_L=5\ \text{pF}$ , $V_{SW}=1.2\ \text{V}$	2.5 to 4.5		50	100	ns
			1.8		75	125	
$t_{OFF}$	Turn-Off Time SEL to Output	$R_L=50\ \Omega$ , $C_L=5\ \text{pF}$ , $V_{SW}=1.2\ \text{V}$	2.5 to 4.5		50	200	ns
			1.8		200	325	
$t_{BBM}$	Break-Before-Make Time	$R_L=50\ \Omega$ , $C_L=5\ \text{pF}$ , $V_{SW}=1.2\ \text{V}$		10	50		ns
$O_{IRR}$	Off Isolation for MIPI <sup>(5)</sup>	$R_L=50\ \Omega$ , $f=750\ \text{MHz}$ , /OE= $V_{CC}$ $V_{SW}=-1\ \text{dBm}$ (200 mV <sub>PP</sub> )	1.65 to 4.5		-18		dB
$X_{TALK}$	Crosstalk for MIPI <sup>(5)</sup>	$R_L=50\ \Omega$ , $f=750\ \text{MHz}$ , $V_{SW}=-1\ \text{dBm}$ (200 mV <sub>PP</sub> )	1.65 to 4.5		-25		dB
BW	-3db Bandwidth <sup>(5)</sup>	$R_L=50\ \Omega$ , $C_L=0\ \text{pF}$	3.0	1100	1600		MHz
$S_{DD21}$	Differential Data Rate	Inter-operability Data Rate	3.0		1.5		Gbps

### Note:

- Guaranteed by characterization.

## High-Speed-Related AC Electrical Characteristics

Symbol	Parameter	Conditions	V <sub>CC</sub> (V)	T <sub>A</sub> =- 40°C to +85°C			Unit
				Min.	Typ.	Max.	
t <sub>SK(O)</sub>	Channel-to-Channel Single-Ended Skew <sup>(6)</sup>	TDR-Based Method (V <sub>SW</sub> =0.2 V <sub>PP</sub> , C <sub>L</sub> =C <sub>ON</sub> )	3.3		6	20	ps
t <sub>SK(P)</sub>	Skew of Opposite Transitions of the Same Output <sup>(6)</sup>	TDR-Based Method (V <sub>SW</sub> =0.2 V <sub>PP</sub> , C <sub>L</sub> =C <sub>ON</sub> )	3.3		6	20	ps

### Note:

6. Guaranteed by characterization.

## Capacitance

Symbol	Parameter	Conditions	T <sub>A</sub> =- 40°C to +85°C			Unit
			Min.	Typ.	Max.	
C <sub>IN</sub>	Control Pin Input Capacitance	V <sub>CC</sub> =0 V, f=1 MHz		2.1		pF
C <sub>ON</sub>	Out On Capacitance	V <sub>CC</sub> =3.3 V, /OE=0 V, f=1 MHz		5.2		
C <sub>OFF</sub>	Out Off Capacitance	V <sub>CC</sub> and /OE=3.3 V, f=1 MHz		2.0		

## Ordering Information

Part Number	Top Mark	Package	D	E	X	Y
FSA644UCX	M7	36-Ball WLCSP, Non-JEDEC 2.36 mm x 2.36 mm, 0.4 mm Pitch	2.36 mm	2.36 mm	0.18 mm	0.18 mm
FSA644BUCX	KM	36-Ball WLCSP, Non-JEDEC 2.415 mm x 2.415 mm, 0.4 mm Pitch	2.415 mm	2.415 mm	0.208 mm	0.208 mm



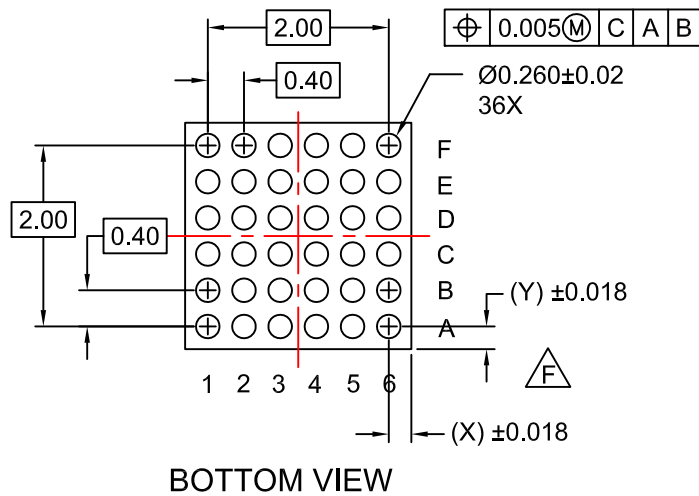
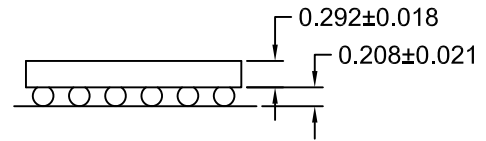
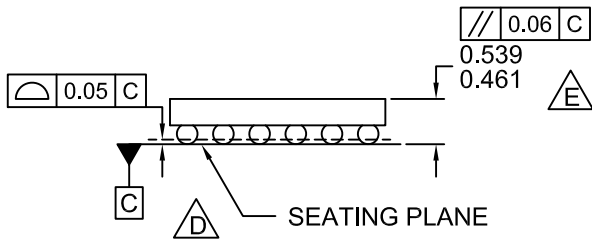
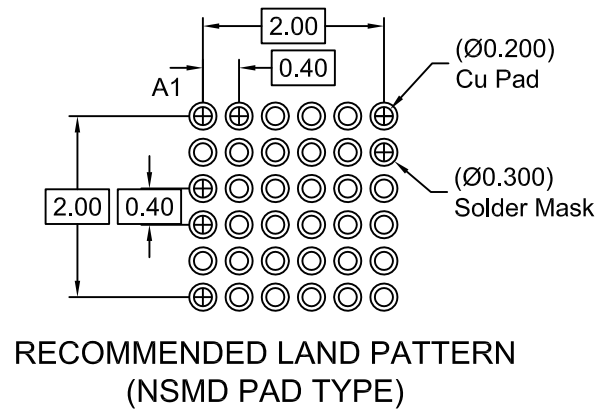
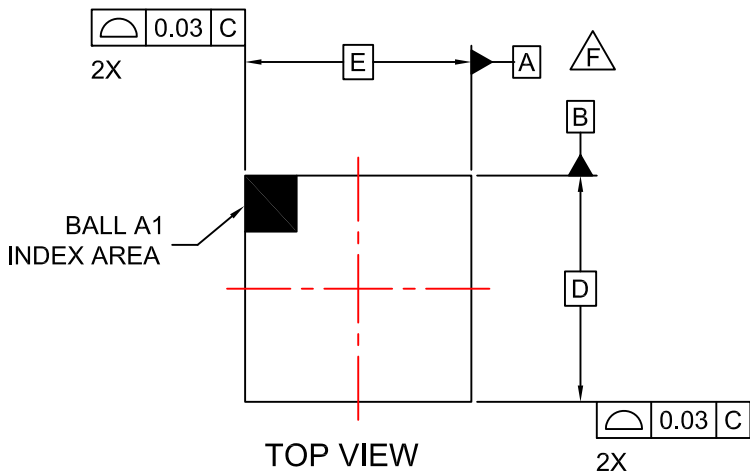

## NOTES

- A. NO JEDEC REGISTRATION APPLIES.
- B. DIMENSIONS ARE IN MILLIMETERS.
- C. DIMENSIONS AND TOLERANCE PER ASMEY14.5M, 1994.
- D. DATUM C IS DEFINED BY THE SPHERICAL CROWNS OF THE BALLS.
- E. PACKAGE NOMINAL HEIGHT IS  $500 \pm 39$  MICRONS (461-539 MICRONS).
- F. FOR DIMENSIONS D, E, X, AND Y SEE PRODUCT DATASHEET.
- G. DRAWING FILNAME: MKT-UC036AArev1.

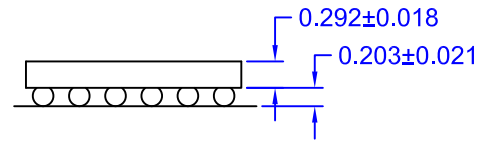
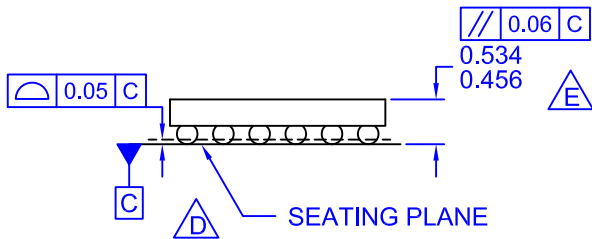
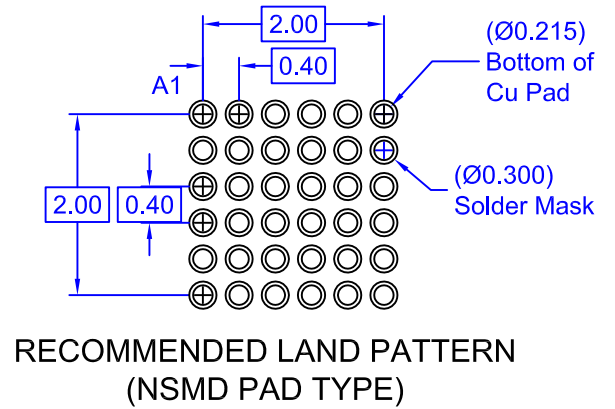
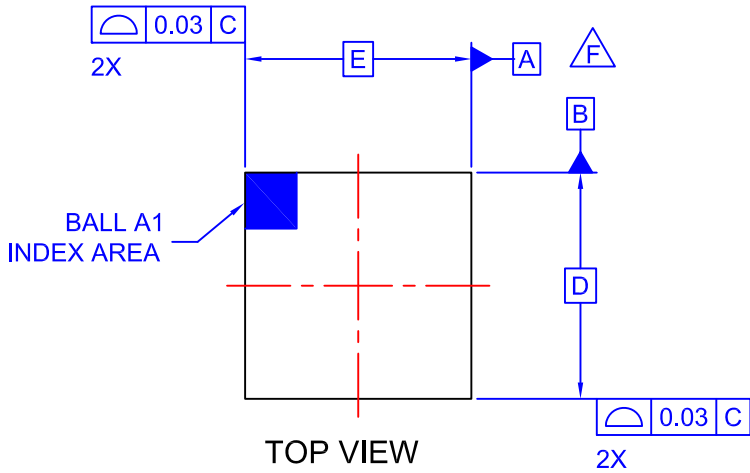

SIDE VIEWS

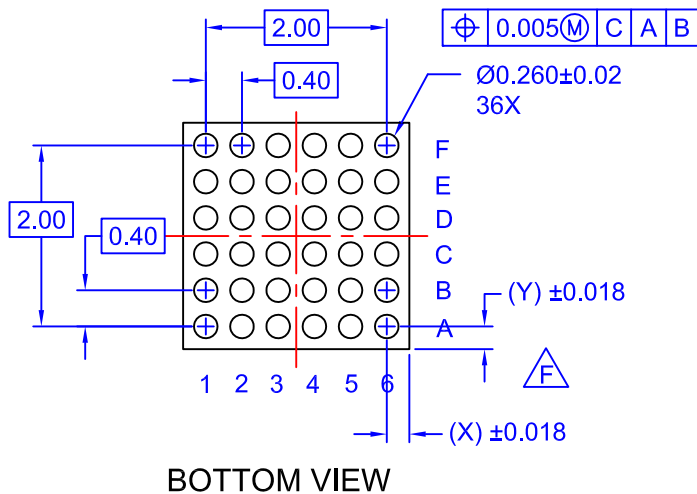

NOTES

- A. NO JEDEC REGISTRATION APPLIES.
- B. DIMENSIONS ARE IN MILLIMETERS.
- C. DIMENSIONS AND TOLERANCE PER ASMEY14.5M, 2009.
- D. DATUM C IS DEFINED BY THE SPHERICAL CROWNS OF THE BALLS.
- E. PACKAGE NOMINAL HEIGHT IS  $495 \pm 39$  MICRONS (456-534 MICRONS).
- F. FOR DIMENSIONS D, E, X, AND Y SEE PRODUCT DATASHEET.
- G. DRAWING FILNAME: MKT-UC036AB REV1.



ON Semiconductor and  are trademarks of Semiconductor Components Industries, LLC dba ON Semiconductor or its subsidiaries in the United States and/or other countries. ON Semiconductor owns the rights to a number of patents, trademarks, copyrights, trade secrets, and other intellectual property. A listing of ON Semiconductor's product/patent coverage may be accessed at [www.onsemi.com/site/pdf/Patent-Marking.pdf](http://www.onsemi.com/site/pdf/Patent-Marking.pdf). ON Semiconductor reserves the right to make changes without further notice to any products herein. ON Semiconductor makes no warranty, representation or guarantee regarding the suitability of its products for any particular purpose, nor does ON Semiconductor assume any liability arising out of the application or use of any product or circuit, and specifically disclaims any and all liability, including without limitation special, consequential or incidental damages. Buyer is responsible for its products and applications using ON Semiconductor products, including compliance with all laws, regulations and safety requirements or standards, regardless of any support or applications information provided by ON Semiconductor. "Typical" parameters which may be provided in ON Semiconductor data sheets and/or specifications can and do vary in different applications and actual performance may vary over time. All operating parameters, including "Typicals" must be validated for each customer application by customer's technical experts. ON Semiconductor does not convey any license under its patent rights nor the rights of others. ON Semiconductor products are not designed, intended, or authorized for use as a critical component in life support systems or any FDA Class 3 medical devices or medical devices with a same or similar classification in a foreign jurisdiction or any devices intended for implantation in the human body. Should Buyer purchase or use ON Semiconductor products for any such unintended or unauthorized application, Buyer shall indemnify and hold ON Semiconductor and its officers, employees, subsidiaries, affiliates, and distributors harmless against all claims, costs, damages, and expenses, and reasonable attorney fees arising out of, directly or indirectly, any claim of personal injury or death associated with such unintended or unauthorized use, even if such claim alleges that ON Semiconductor was negligent regarding the design or manufacture of the part. ON Semiconductor is an Equal Opportunity/Affirmative Action Employer. This literature is subject to all applicable copyright laws and is not for resale in any manner.

## PUBLICATION ORDERING INFORMATION

### LITERATURE FULFILLMENT:

Literature Distribution Center for ON Semiconductor  
19521 E. 32nd Pkwy, Aurora, Colorado 80011 USA  
**Phone:** 303-675-2175 or 800-344-3860 Toll Free USA/Canada  
**Fax:** 303-675-2176 or 800-344-3867 Toll Free USA/Canada  
**Email:** [orderlit@onsemi.com](mailto:orderlit@onsemi.com)

**N. American Technical Support:** 800-282-9855 Toll Free  
USA/Canada  
**Europe, Middle East and Africa Technical Support:**  
Phone: 421 33 790 2910  
**Japan Customer Focus Center**  
Phone: 81-3-5817-1050

**ON Semiconductor Website:** [www.onsemi.com](http://www.onsemi.com)  
**Order Literature:** <http://www.onsemi.com/orderlit>  
For additional information, please contact your local  
Sales Representative

# Mouser Electronics

Authorized Distributor

Click to View Pricing, Inventory, Delivery & Lifecycle Information:

[ON Semiconductor:](#)

[FSA644UCX](#) [FSA644BUCX](#)



## Стандарт Электрон Связь

Мы молодая и активно развивающаяся компания в области поставок электронных компонентов. Мы поставляем электронные компоненты отечественного и импортного производства напрямую от производителей и с крупнейших складов мира.

Благодаря сотрудничеству с мировыми поставщиками мы осуществляем комплексные и плановые поставки широчайшего спектра электронных компонентов.

Собственная эффективная логистика и склад в обеспечивает надежную поставку продукции в точно указанные сроки по всей России.

Мы осуществляем техническую поддержку нашим клиентам и предпродажную проверку качества продукции. На все поставляемые продукты мы предоставляем гарантию .

Осуществляем поставки продукции под контролем ВП МО РФ на предприятия военно-промышленного комплекса России , а также работаем в рамках 275 ФЗ с открытием отдельных счетов в уполномоченном банке. Система менеджмента качества компании соответствует требованиям ГОСТ ISO 9001.

Минимальные сроки поставки, гибкие цены, неограниченный ассортимент и индивидуальный подход к клиентам являются основой для выстраивания долгосрочного и эффективного сотрудничества с предприятиями радиоэлектронной промышленности, предприятиями ВПК и научно-исследовательскими институтами России.

С нами вы становитесь еще успешнее!

### Наши контакты:

**Телефон:** +7 812 627 14 35

**Электронная почта:** [sales@st-electron.ru](mailto:sales@st-electron.ru)

**Адрес:** 198099, Санкт-Петербург,  
Промышленная ул, дом № 19, литера Н,  
помещение 100-Н Офис 331