

LCD Module Technical Specification

First Edition
JUN.04, 2012

Final Revision

Type No. **TVL-55684D140U-LW-I-ABN**

Customer :

Customer's Product No. :

KYOCERA Display Corporation

Approved : *Teruo Kuragane*
QUALITY ASSURANCE DIVISION

Checked : *Yasutaka Oiwa*
Design Div.

Prepared : *Masayuki Kato*
Design Div.

APPROVED

By _____

Signature :

Date :

Please return this specification within two month with your signature.
If not returned within two month, specification will be considered
as having been accepted.

1. General Descriptions

1.1 Introduction

The TVL-55684D140U-LW-I-ABN is a color active matrix thin film transistor (TFT) TN liquid crystal display (LCD) that uses amorphous silicon TFT as a switching device. It is composed of a TFT LCD panel, a timing controller, voltage reference, common voltage, column driver, and row driver circuit. This TFT LCD has a 14.0-inch diagonally measured active display area with resolution (1,366 horizontal by 768 vertical pixel array).

1.2 Features

- 14.0" TN TFT LCD Panel
- LED Backlight System
- Supported (1,366x768 pixels) Resolution
- Compatible with RoHS Standard

1.3 Product Summary

Items	Specifications	Unit
Screen Diagonal	14.0	Inch
Active Area	309.399 (H) x 173.952 (V)	mm
Pixels H x V	1,366 x3(RGB) x 768	-
Pixel Pitch	0.2265x0.2265	mm
Pixel Arrangement	R.G.B. Vertical Stripe	-
Display Mode	Normally White	-
White Luminance	200 (Typ.) 5 Points Average	cd /m ²
Contrast Ratio	500 (Typ.)	-
Response Time	8 (Typ.)	msec
Input Voltage	3.3 (Typ.)	V
Power Consumption	3.8 (Max.)	watt
Weight	355(Max.)	g
Outline Dimension	323.5(Typ.) x 192.0(Typ.) x 5.2 (Max.)	mm
Electrical Interface (Logic)	Single LVDS	-
Support Color	262 K	-
Optimum Viewing Direction	12 o'clock(Not color Inversion Direction)	-
	6 o'clock(CR Max Direction)	-
Surface Treatment	Glare + HC	-

1.4 Functional Block Diagram

Figure 1 shows the functional block diagram of the LCD module.

Figure 1 Block Diagram

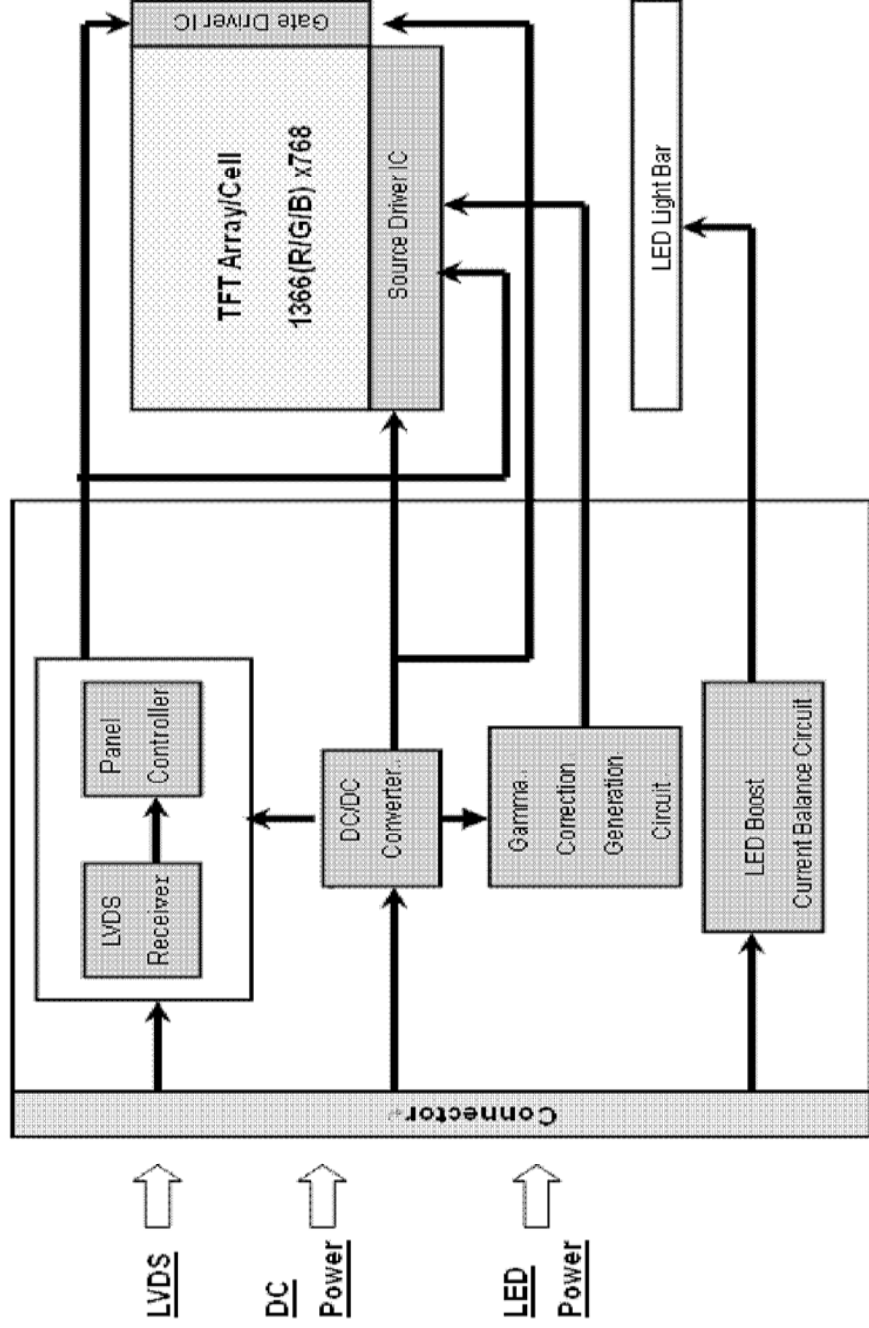

1.5 Pixel Format Image

Figure 2 shows the relationship of the input signals and LCD pixel format image.

Figure 2 Pixel Format

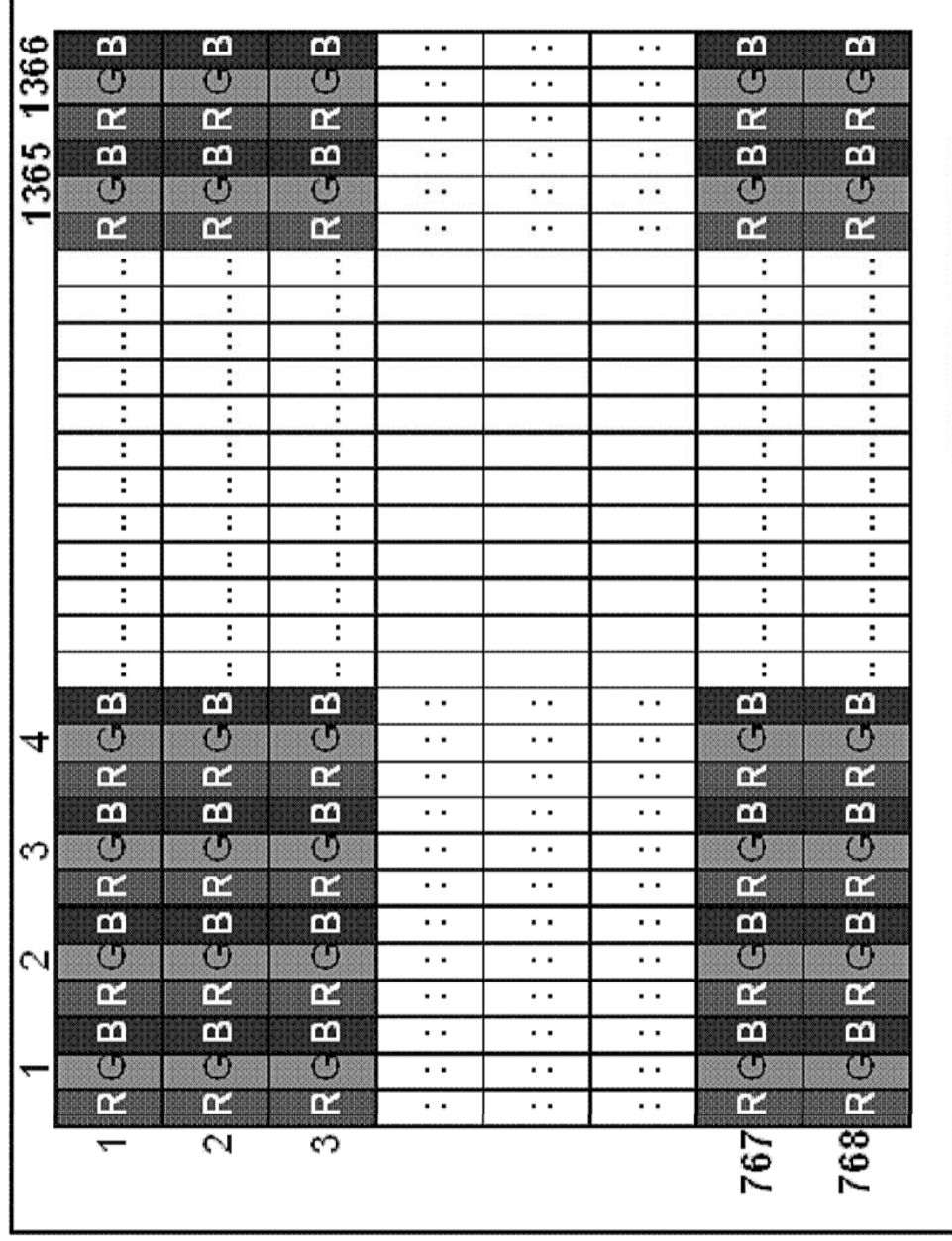

2. Absolute Maximum Ratings

The followings are maximum values which, if exceeded, may cause faulty operation or damage to the LCD module.

Table 1 Absolute Ratings of Environment

Item	Symbol	Min.	Max.	Unit	Conditions
Supply Voltage	VDD	-0.5	4.0	V	-
Supply V_LED Voltage	V_LED	6	21	V	-
Input Signal	-	-0.3	2.6	V	LVDS signals
Operating Temperature	TOP	0	50	deg. C	(Note)
Operating Humidity	HOP	10	80	%RH	(Note)
Storage Temperature	TST	-20	60	deg. C	(Note)
Storage Humidity	HST	10	90	%RH	(Note)
Vibration	-	-	1.5G 10-500Hz Random	G Hz	30Mins for X, Y, Z axis
Shock	-	-	220G 2ms	G ms	Half sine wave

Note:

- (1) Maximum Wet-Bulb should be 39°C and No condensation.
- (2) When you apply the LCD module for OA system. Please make sure to keep the temperature of LCD module is less than 60°C.
- (3) Storage/Operating temperature.

Figure 3 Absolute Ratings of Environment of the LCD module

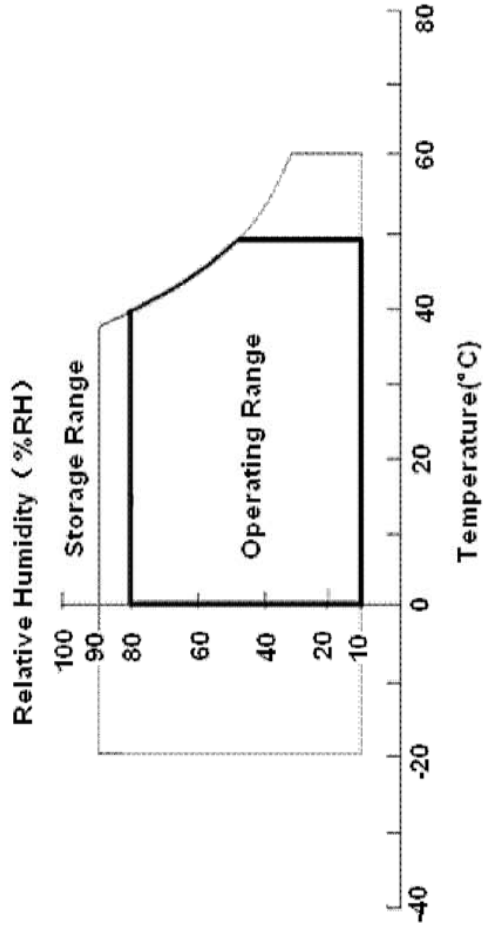

3. Electrical Specification

3.1 Interface Connector

Table 2 Connector Name / Designation

Manufacturer	I-PEX (or equivalent)
Mating Receptacle / Part Number	IPEX 20453-040T-11/111B40-1210TA-G3

Table 3 Signal Pin Assignment

Pin #	Signal Name	Description	Remarks
1	NC	Not Connected	Reserve
2	VDD	Power Supply	3.3V(Typ.)
3	VDD	Power Supply	3.3V(Typ.)
4	NC	Connect to internal circuit	Must be left open
5	BIST	Panel Self Test	High Enable
6	NC	Connect to internal circuit	Must be left open
7	NC	Connect to internal circuit	Must be left open
8	RX 0-	LVDS differential data input	-
9	RX 0+	LVDS differential data input	-
10	GND	Ground	-
11	RX 1-	LVDS differential data input	-
12	RX 1+	LVDS differential data input	-
13	GND	Ground	-
14	RX 2-	LVDS differential data input	-
15	RX 2+	LVDS differential data input	-
16	GND	Ground	-
17	RX CLK-	LVDS differential clock input	-
18	RX CLK+	LVDS differential clock input	-
19	NC	Not connected	Reserve
20	NC	Not connected	Reserve
21	NC	Not connected	Reserve
22	GND	GND	-
23	NC	Not connected	Reserve
24	NC	Not connected	Reserve
25	GND	GND	-
26	NC	Not connected	Reserve
27	NC	Not connected	Reserve
28	GND	GND	-

Pin #	Signal Name	Description	Remarks
29	NC	Not Connected	Reserve
30	NC	Not Connected	Reserve
31	LED_GND	LED Ground	-
32	LED_GND	LED Ground	-
33	LED_GND	LED Ground	-
34	NC	Not Connected	Reserve
35	V PWM_EN	System PWM Signal Input	High Enable
36	V LED_EN	LED Enable Input Level	High Enable
37	V_DBC_EN	Dynamic Backlight Control	High Enable
38	V LED	LED Power Supply	12V(typical)
39	V LED	LED Power Supply	12V(typical)
40	V LED	LED Power Supply	12V(typical)

Note: All input signals shall be at low or Hi-Z state when VDD is off.

3.2 LVDS Receiver

3.3.1 Signal Electrical Characteristics For LVDS Receiver

The built-in LVDS receiver is compatible with (ANSI/TIA/TIA-644) standard.

Table 4 LVDS Receiver Electrical Characteristics

Parameter	Symbol	Min.	Typ.	Max.	Unit	Conditions
Differential Input High Threshold	V _{th}	-	-	+100	mV	V _{cm} =+1.2V
Differential Input Low Threshold	V _{tl}	-100	-	-	mV	V _{cm} =+1.2V
Magnitude Differential Input Voltage	V _{id}	100	-	600	mV	
Common Mode Voltage	V _{cm}	1.0	1.2	1.4	V	
Common Mode Voltage Offset	ΔV _{cm}	-	-	50	mV	V _{cm} =+1.2V

Note:

- (1) Input signals shall be at low or Hi-Z state when VDD is off.
- (2) All electrical characteristics for LVDS signal are defined and shall be measured at the interface connector of LCD.

Figure 4 Voltage Definitions

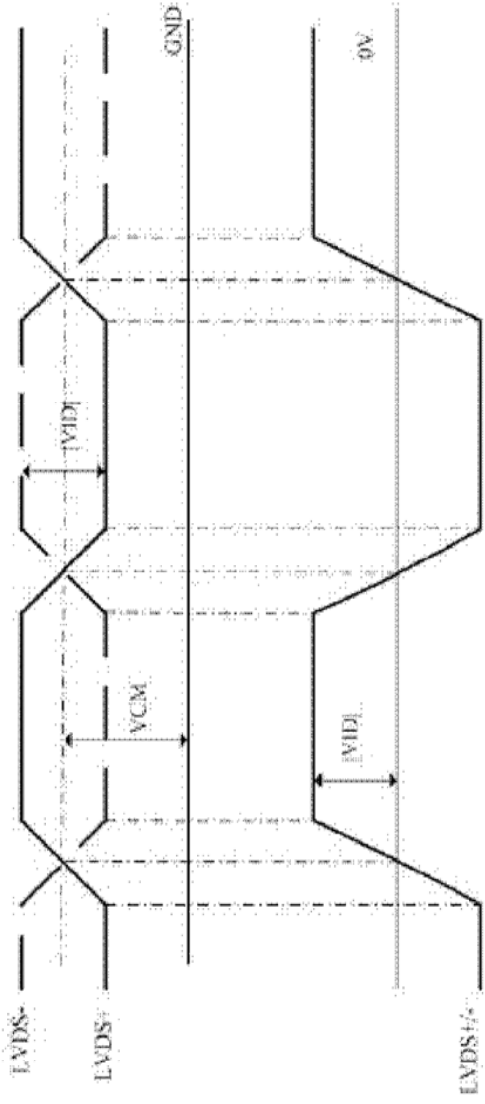

Figure 5 Measurement System

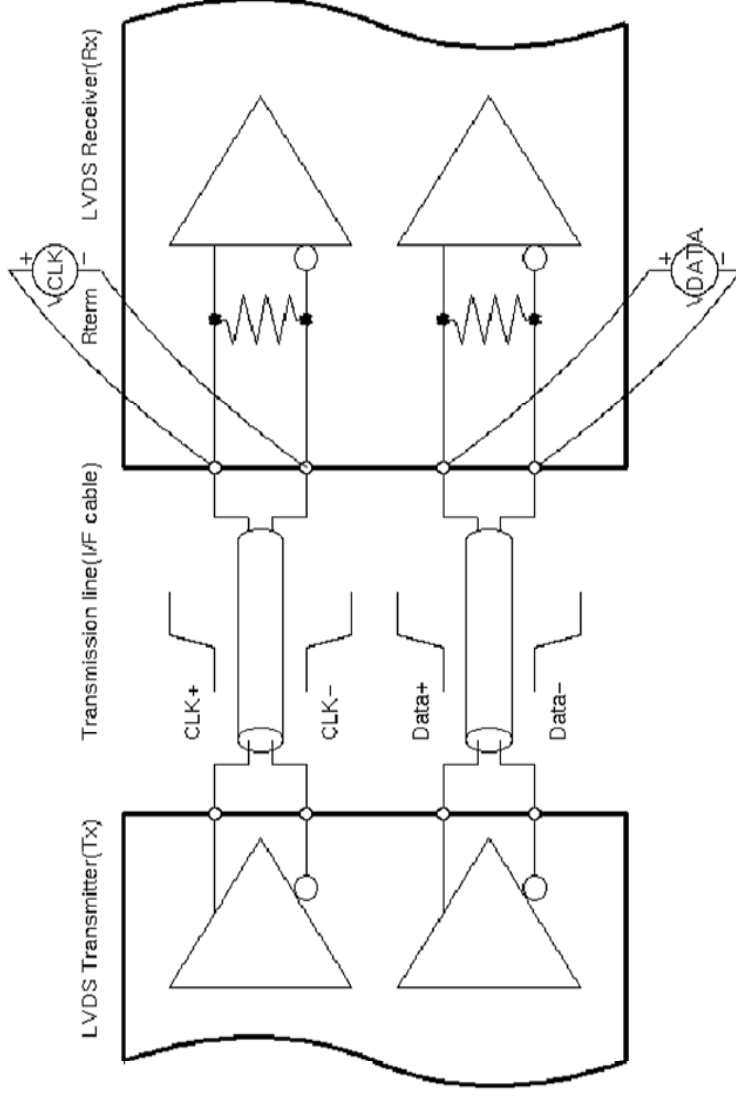
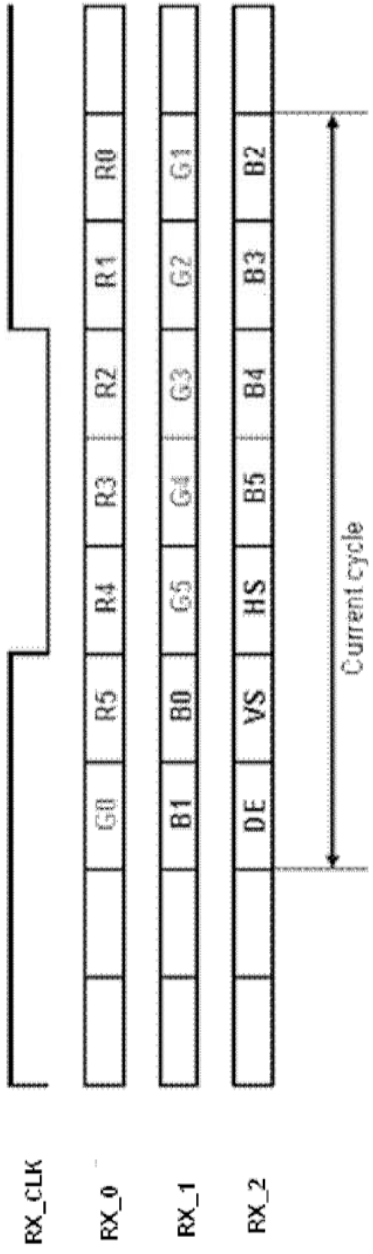

Figure 6 Data mapping



3.3.2 LVDS Receiver Internal Circuit

LVDS Receiver Internal Circuit shows the internal block diagram of the LVDS receiver. This LCD module equips termination resistors for LVDS link.

Figure 7 LVDS Receiver Internal Circuit

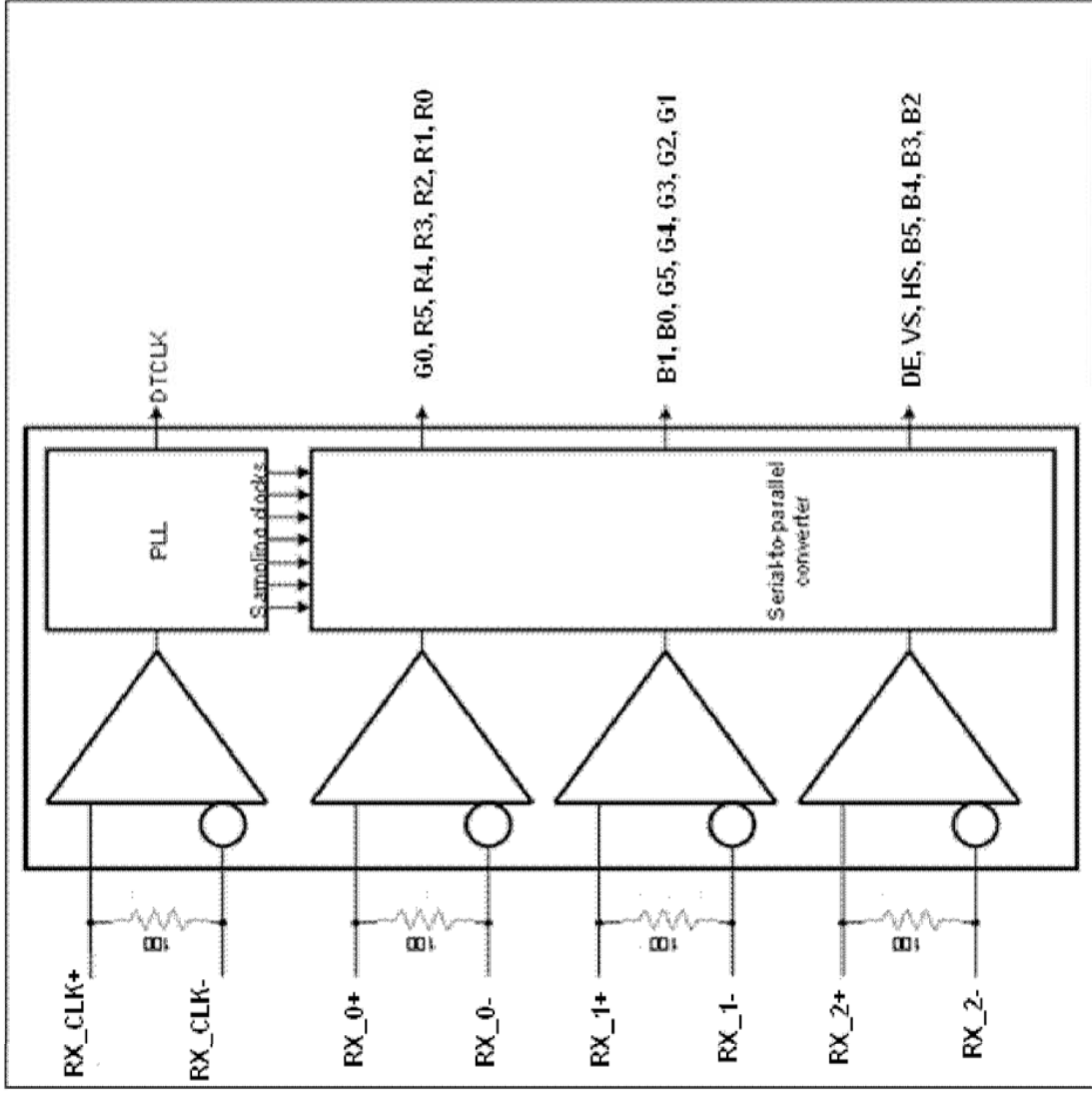

3.3 Interface Timings

Table 5 Interface Timings

Parameter	Symbol	Unit	Min.	Typ.	Max.
LVDS Clock Frequency(single)	F _{clk}	MHz	65	77.9	85
H Total Time	H _{total}	Clocks	1,396	1,606	2,047
H Active Time	H _{ac}	Clocks	1,366	1,366	1,366
V Total Time	V _{total}	Lines	776	808	1023
V Active Time	V _{ac}	Lines	768	768	768
Frame Rate	V _{sync}	Hz	55	60	65

Figure 8 Timing Characteristics

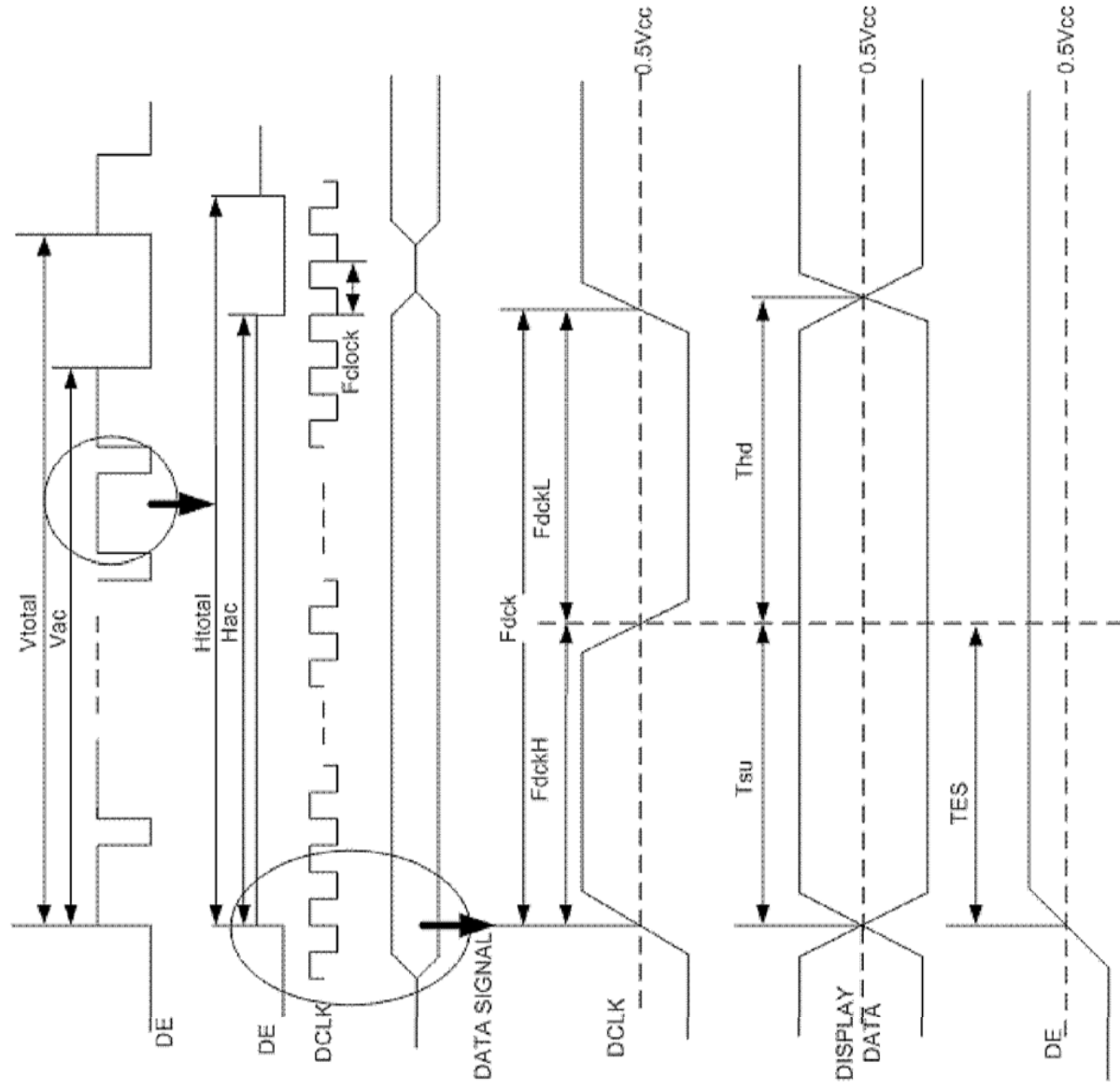

Note: TES is data enable signal setup time.

3.4 Power Consumption

Input power specifications are as follows.

Table 6 Power Consumption

Parameter	Symbol	Min	Typ.	Max	Units	Condition
Logic / LCD Drive Voltage	VDD	3.0	3.3	3.6	[V]	-
VDD Current	IDD	-	0.27	-	[A]	Black pattern, 60Hz
VDD Power	PDD	-	-	1.0	[W]	Black pattern, 60Hz
Rush Current	Irush	-	-	2.0	[A]	Note(1)
Allowable Logic / LCD Drive Ripple Voltage	VDDrp	-	-	200	[mVp-p]	-
LED Power Consumption	PLED	-	2.6	2.8	[W]	-

Note:

(1) Measure Condition

Figure 9 VDD Rising Time

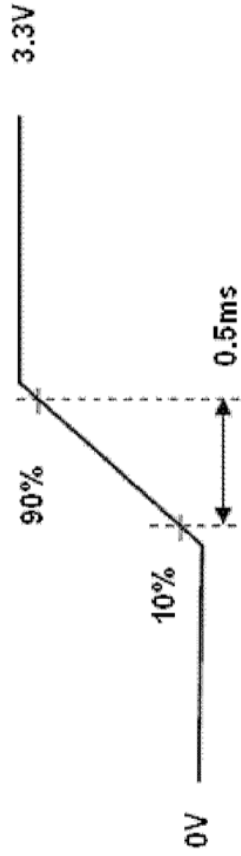

VDD rising time

(2) VDD Power Dip Condition

Figure 10 VDD Power Dip

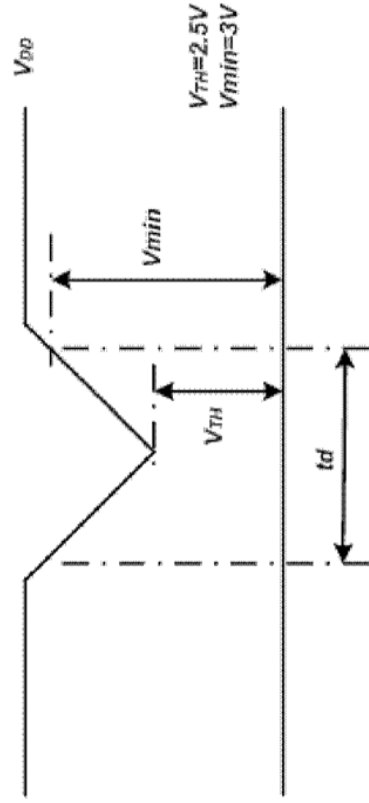

If $V_{TH} < V_{DD} \leq V_{min}$, then $t_d \leq 10ms$; when the voltage return to normal our panel must revive automatically.

3.5 Power ON/OFF Sequence

VDD power, interface signals, and lamp on/off sequence are showing on Figure 10. Signals shall be Hi-Z state or low level when VDD is off.

Figure 11 Power Sequence

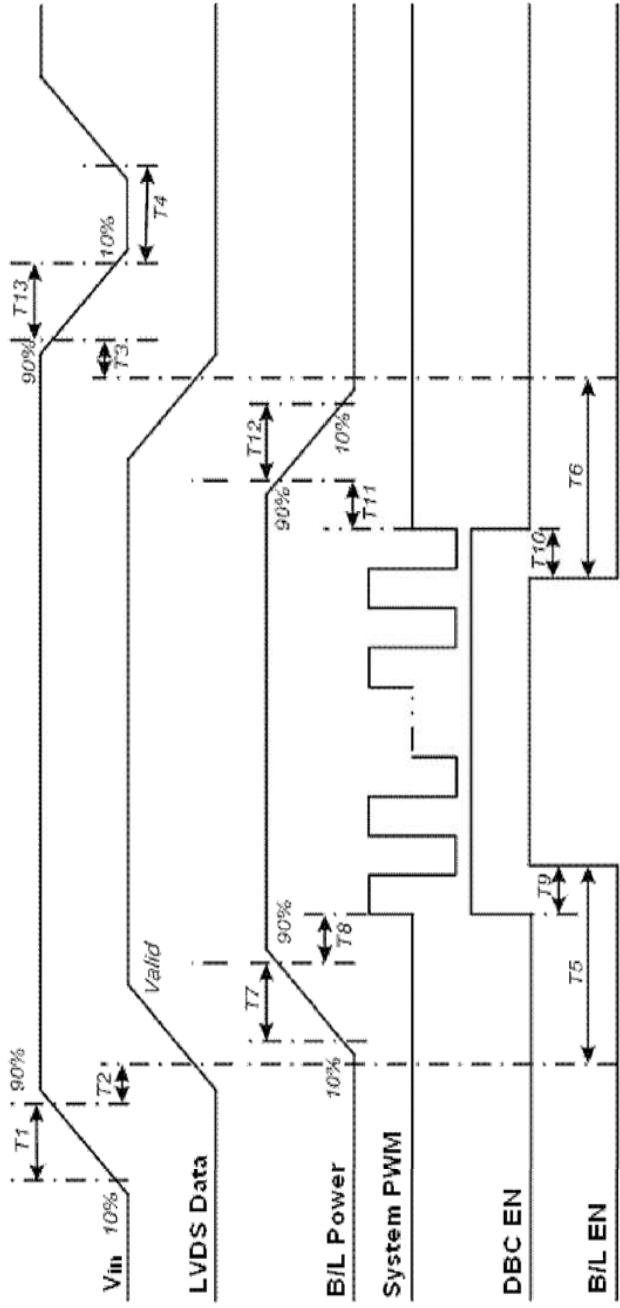

Table 7 Power Sequencing Requirements

Parameter	Symbol	Min.	Typ.	Max.	Unit
VDD Rise Time	T1	0.5	-	10	ms
VDD Good to Signal Valid	T2	0	-	50	ms
Signal Valid to Backlight On	T3	0	-	50	ms
Backlight Power On Time	T4	500	-	-	ms
Backlight V _{DD} Good to System PWM On	T5	200	-	-	ms
System PWM on to Backlight Enable On	T6	200	-	-	ms
Backlight Enable off to System PWM Off	T7	0.5	-	10	ms
System PWM Off to B/L Power Disable	T8	10	-	-	ms
Backlight Power Off Time	T9	10	-	-	ms
Backlight off to Signal Disable	T10	0	-	-	ms
Signal Disable to Power Down	T11	10	-	-	ms
VDD Falling Time	T12	-	10	30	ms
Power Off	T13	500	10	30	ms

4. Backlight Characteristics

4.1 Parameter Guideline of LED Backlight

Table 8 Parameter Guideline for LED Backlight

Symbol	Parameter	Min.	Typ.	Max.	Units	Condition
V_LED	LED Input	6	12	21	[V]	Ta=25°C Note(2)
V_PWM_EN	PWM Signal Voltage	High	-	5.5	V	Ta=25°C
		Low	-	0.5	V	
FPWM	Input PWM Frequency	100	200	1K	Hz	-
V_DBC_EN	DBC Voltage	High	3.3	3.6	V	Ta=25°C
		Low	0	0.5	V	
V_LED_EN	LED Enable Voltage	High	3.3	5.5	V	Ta=25°C
		Low	0	0.5	V	
LT	LED Life Time	10,000	-	-	Hours	Ta=25°C Note(1)
PWM	Duty ratio	5	-	100	%	-

Note:

- (1) The LED life time define as the estimated time to 50% degradation of initial luminous.
- (2) A higher LED power supply voltage will result in better power efficiency. Keep the V_LED between 12V and 21V is strongly recommended.

5. Optical Characteristics

The optical characteristics are measured under stable conditions as following notes.

Table 9 Optical Characteristics

Item	Conditions		Specification				Note		
			Min.	Typ.	Max.	Unit			
Viewing Angle [degrees] K=Contrast Ratio>10	Horizontal	Left	40	45	-	Deg.	(1),(2),(3)		
		Right	40	45	-	Deg.			
	Vertical	Up	10	15	-	Deg.			
		Down	30	35	-	Deg.			
Contrast Ratio	Center	400	500	-	-	(1),(2),(4)			
Response Time [ms]	Rising + Falling	-	8	12	ms	(1),(2),(5)			
Color Chromaticity (CIE1931)	Red	x	Typ. -0.03	0.590	Typ. +0.03	-	(1),(2)		
	Red	y		0.345		-	(1),(2)		
	Green	x		0.340		-	(1),(2)		
	Green	y		0.570		-	(1),(2)		
	Blue	x		0.150		-	(1),(2)		
	Blue	y		0.120		-	(1),(2)		
	White	x		0.263		0.313	0.363	-	(1),(2)
	White	y		0.279		0.329	0.379	-	(1),(2)
White Luminance [cd/m ²]	-	170	200	-	cd/m ²	5point (1),(2),(6)			
Luminance Uniformity [%]	13points	67	-	-	%	(1),(2),(7)			
	5points	80	-	-					

Note:

(1) Measurement Setup

The LCD module should be stabilized at 25°C for 15 minutes to avoid abrupt temperature change during measuring. In order to stabilize the luminance, the measurement should be executed after lighting backlight for 15 minutes in a windless room.

Figure 12 Measurement Setup

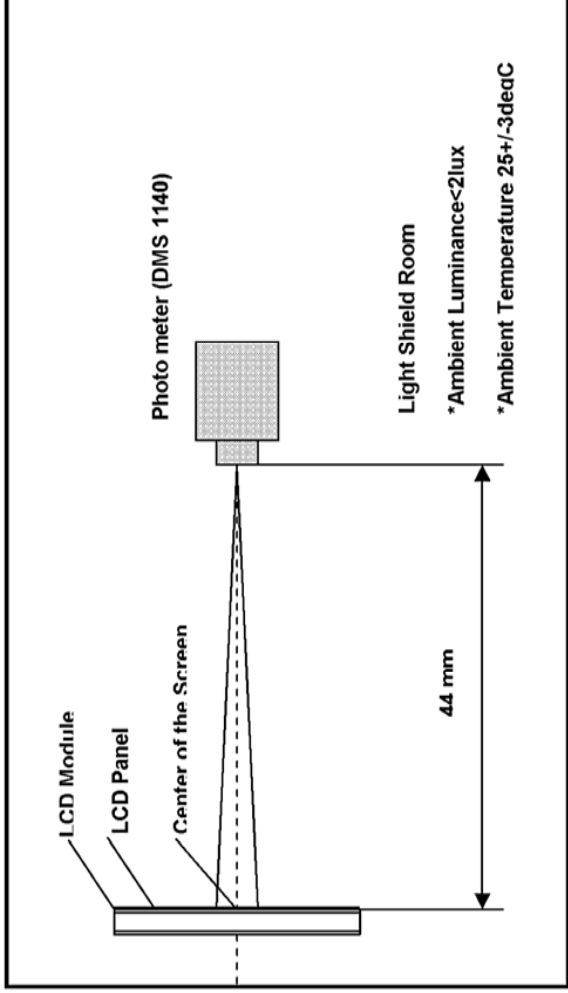

(2) The LED input parameter setting as:

V_LED: 12V ($\pm 0.1\text{V}$)

PWM_LED: duty 100 %

(3) Definition of Viewing Angle

Figure 13 Definition of Viewing Angle

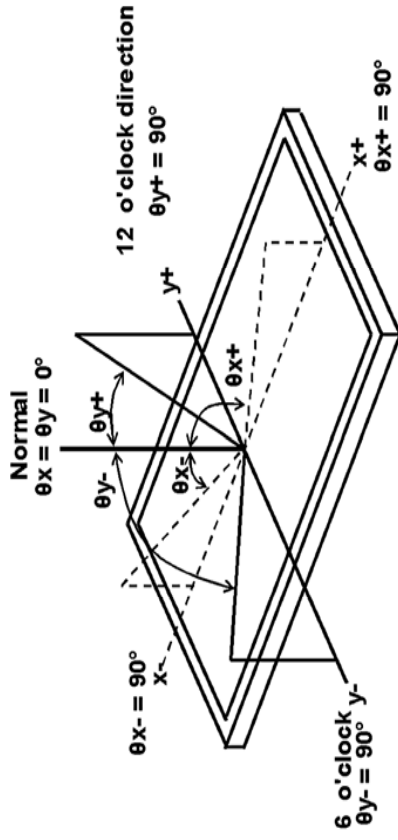

(4) Definition of Contrast Ratio (CR)

The contrast ratio can be calculated by the following expression

Contrast Ratio (CR) = L_{63} / L_0

L63: Luminance of gray level 63, L0: Luminance of gray level 0

(5) Definition of Response Time (T_R , T_F)

Figure 14 Definition of Response Time

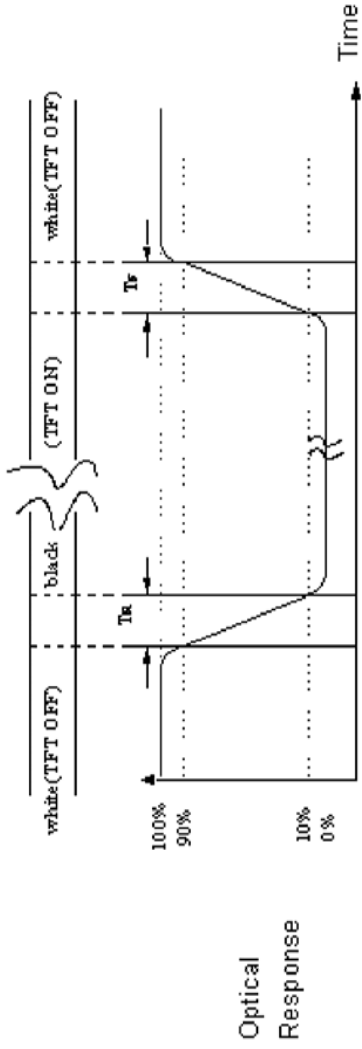

(6) Definition of Luminance White

Measure the luminance of gray level 63 at center point.

$$\text{Display Luminance} = (Y_1 + Y_2 + Y_3 + Y_4 + Y_5) / 5$$

Figure 15 Measurement Locations of 5 Points

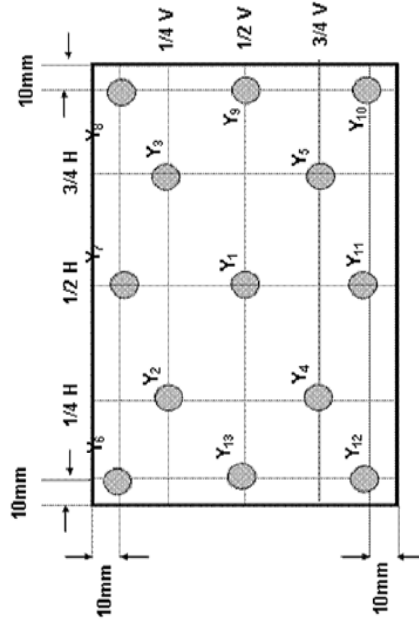

(7) Definition of Luminance Uniformity (Variation)

Measure the luminance of gray level 63 at 13 points.

$$\text{Uniformity of 13 points} = \frac{\text{Min Luminance of } Y_1 \sim Y_{13}}{\text{Max Luminance of } Y_1 \sim Y_{13}} \times 100\%$$

$$\text{Uniformity of 5 points} = \frac{\text{Min Luminance of } Y_1 \sim Y_5}{\text{Max Luminance of } Y_1 \sim Y_5} \times 100\%$$

6. Mechanical Characteristics

6.1 Outline Drawing

Figure 16 Reference Outline Drawing (Front Side)

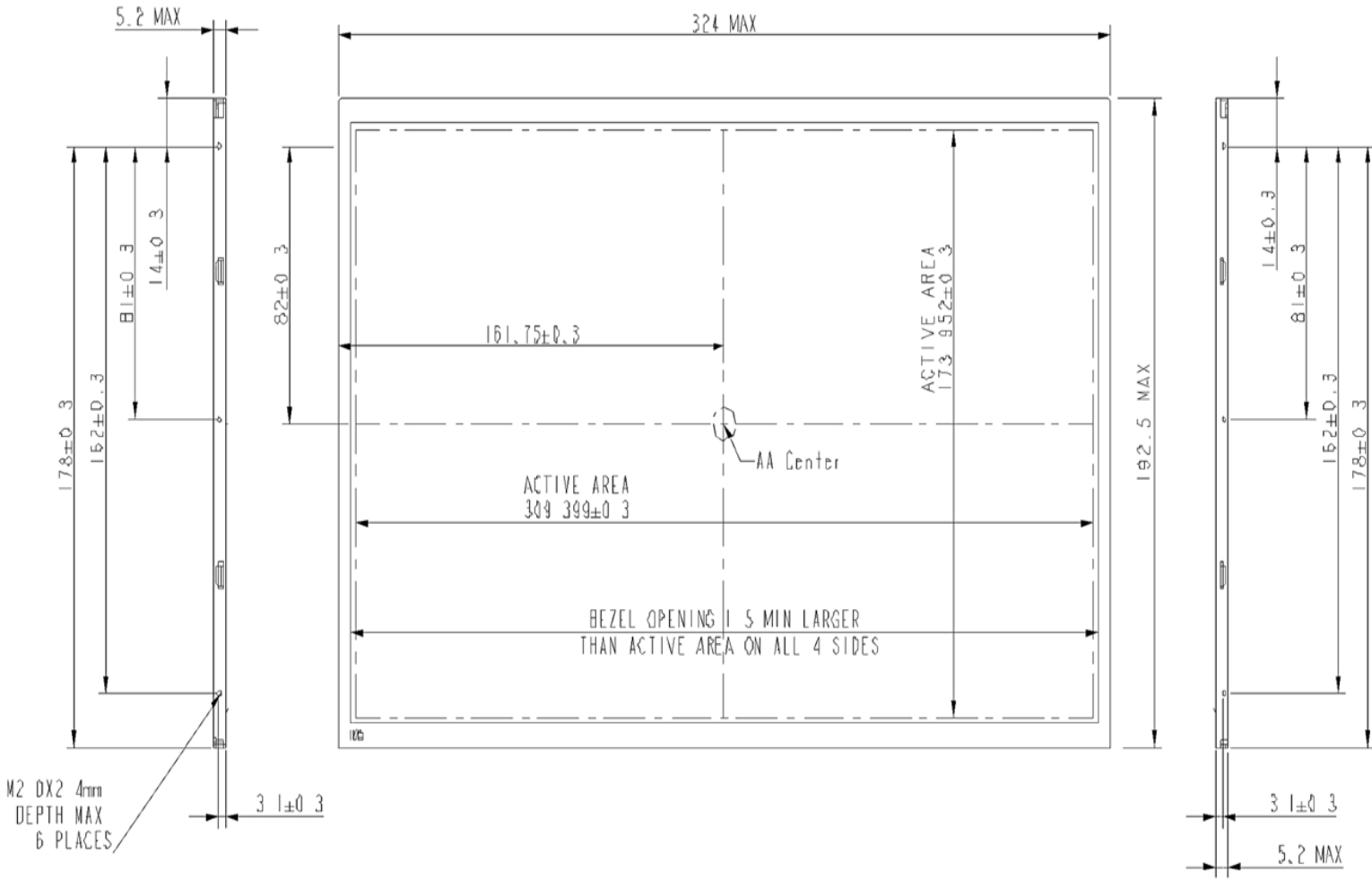
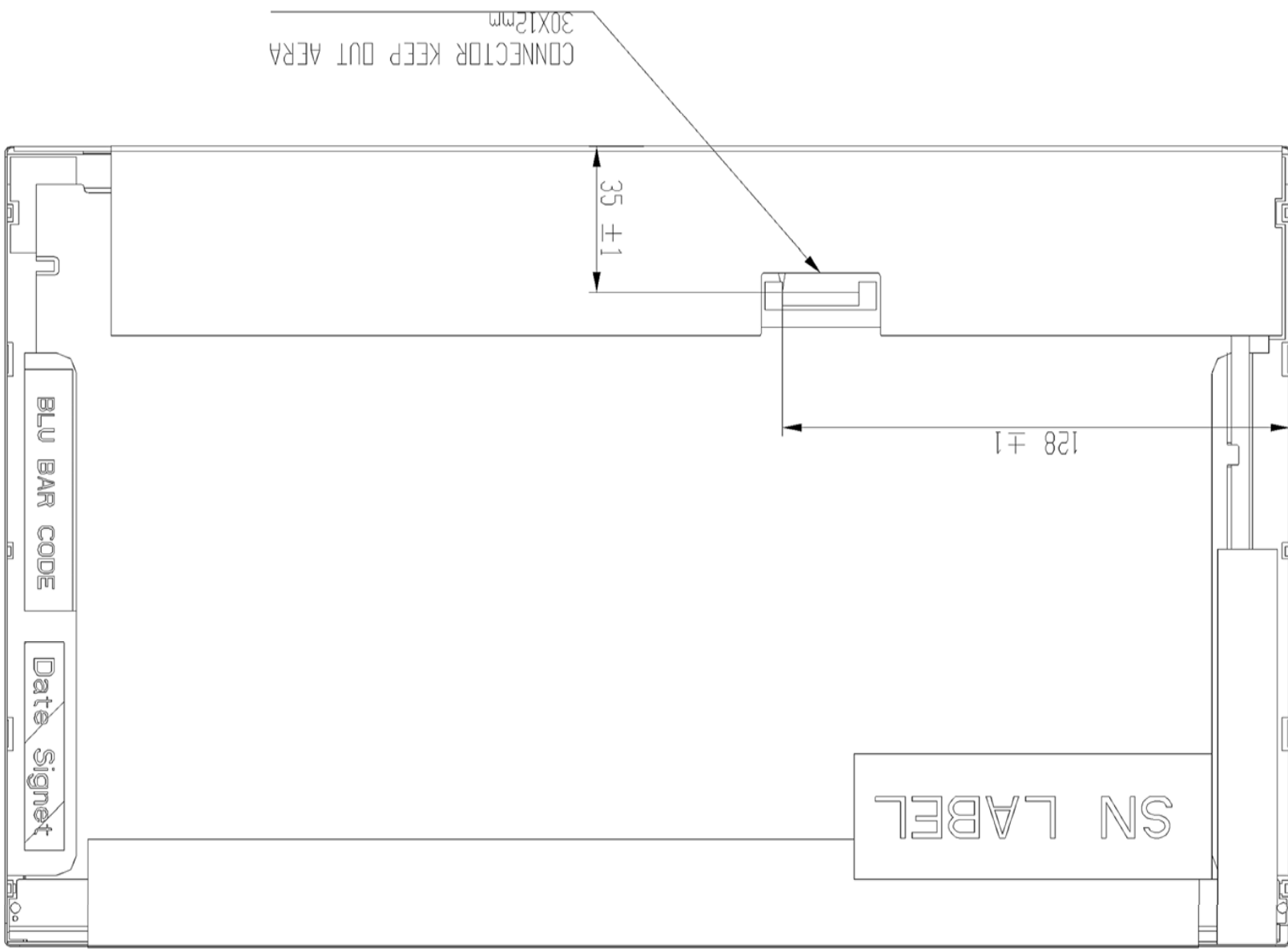

Figure 17 Reference Outline Drawing (Back Side)



6.2 Dimension Specifications

Table 10 Module Dimension Specifications

Item	Value	Unit
Width	323.5 (Typ.), 324.0(Max.)	mm
Height	192.0(Typ.), 192.5(Max.)	mm
Thickness (Max.)	5.2	mm
Weight (Max.)	355	g
BM Width	a-b & c-d	mm

Figure 18 BM Area

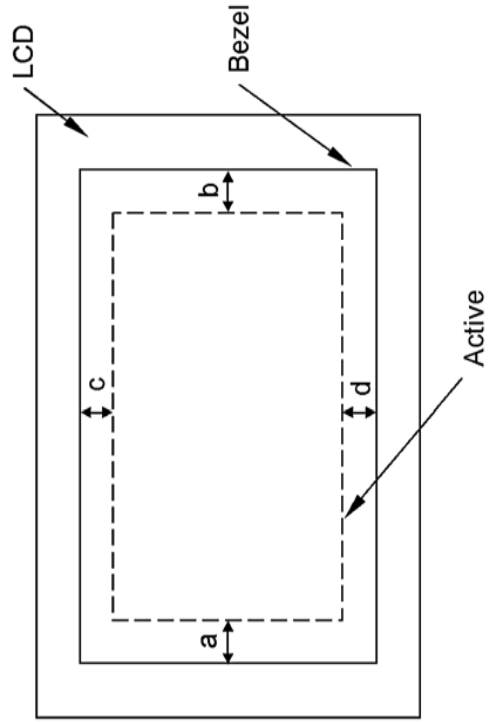

7. Inspection Standards for LCD Modules

7.1 Description

These inspection standards shall be applied to LCD Module supplied by KYOCERA Display Corporation.

7.2 The environmental condition of inspection

The environmental condition and visual inspection shall be conducted as below

- (1) Ambient temperature: 15~25°C
 - (2) Humidity: 25~75%RH
 - (3) External appearance inspection shall be conducted by using a single 20W fluorescent lamp or equivalent illumination.
 - (4) Panel visual inspection on the operation condition for cosmetic shall be conducted at the distance 35cm or more between the LCD module and eyes of inspector. And, the viewing angle shall be 90 degree to the front surface of display panel
- Ambient Illumination: 400~600 Lux for external appearance inspection
Ambient Illumination: 100~200 Lux for light on inspection

7.3 Method of sampling inspection

Unless defined in the other document, the sampling method shall be in accordance with MIL-STD-105E.

- (1) Lot size: quantity of per delivery for inspection per model
- (2) Sampling type: Normal inspection, single sampling
- (3) Sampling table: MIL-STD-105E

7.4 Classification of defects

Defects are classified two types, major defect according to the defect. And, the definition of defects is classified as below.

(1) Major defect

Any defect may result in functional failure, or reduce the usability of product for its purpose. For example, electrical failure, deformation and etc.

(2) Minor defect

A defect that is not to reduce the usability of product for its intended purpose and un-uniformity, dot defect and etc..

The criteria on major and/or minor judgment will be according with the classification of defects.

7.5 Acceptable quality level (AQL)

AQL means that the quality level of product is acceptable for shipment, and the AQL shall satisfy with customer's quality request.

The AQL (%) for major or minor defect are expressed as below respectively.

- (1) Major defect: 0.6%
- (2) Minor defect: 0.8%

7.6 Inspection Criteria

7.6.1 Definition of dot defect

- a) The definition of dot: The size of a defective dot over 1/2 of whole dot is regarded as one defective dot.
 b) Bright dot: Dots appear bright and unchanged in size in which LCD panel is displaying under black pattern.
 c) Dark dot: Dots appear dark and unchanged in size in which LCD panel is displaying under pure red, green, blue picture.
 d) 2 dot adjacent=1pair=2dots

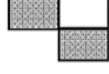

2 dot adjacent

2 dot adjacent

2 dot adjacent(vertical)

2 dot adjacent(slant)

7.6.2 Display Inspection criteria

Item	Acceptable count	
Bright dot	Random	$N \leq 6$
	2 dots adjacent (pair)	$N \leq 2$
	3 dots adjacent or more	$N \leq 1$
Dark dot	Random	$N \leq 7$
	2 dots adjacent (pair)	$N \leq 3$
	3 dots adjacent or more	$N \leq 2$
Distance	Minimum Distance Between Bright dots	$L \geq 15\text{mm}$
	Minimum Distance Between Dark dots	$L \geq 5\text{mm}$
Total bright and dark dot	$N \leq 8$	
Display failure (V-line/H-line/Cross line etc.)	Not allowable	
Mura	Judge by limit sample or not visible through ND filter	3%

7.6.3 Appearance inspection criteria

Item	Standards
Foreign Black / White Spots	0.5mm<D ≤ 1.0mm, N ≤ 5
Foreign Lint	0.1mm<W ≤ 0.2mm, 5mm<L ≤ 10.0mm, N ≤ 8
Polarizer Bubble/Dent	0.5mm<D _L ≤ 1.0mm, N _L ≤ 5
Polarizer Scratches	0.1mm<W ≤ 0.2mm, 5.0mm<L ≤ 10.0mm, N ≤ 8

7.6.4 External appearance inspection criteria

Item	Contents
Screw	Parts mounting, incomplete assembly, deformation, oxidized, crooked or rusty is not permitted.
Metal frame (Bezel)	Scratch *Noticeable scratch and exfoliation coating are not permitted. *The oxidized metal is not permitted.
	Incomplete assembly is not permitted.
Backlight	Scratch The scratch which may cause a problem in practical use is not permitted.
	Break-off Breaking off is not permitted.
	Crack The crack is not permitted.
Stain on Polarizer	The stain which can't be wiped off is not permitted.
Tape/Label	Incorrect position, missed label is not permitted.
Connector	Oxidized/rusty connector is not permitted.
Outline size	Spec. out is not permitted.

7.6.5. Classification of defects

Inspection Item	Criteria and Description	Defect type
Vertical line	Signal input, vertical line off or abnormal V-line appears	Major
Horizontal line	Signal input, horizontal line off or abnormal H-line appears	Major
Cross line	Pattern signal input, a correct display is not obtained	Major
No display	Signal input, display is dead	Major
Abnormal display	Pattern signal input, a correct display is not obtained	Major
Bezel finger	Bezel finger is missed or not bent	Major
Outline size	Length, Wide, High,	Major
Dots defect	Exceed specified standards	Minor
Light leakage	Visible light leakage appears around the edges of screen	Minor
Foreign material	Exceed specified standards	Minor
External Appearance	A appearance defect that do not affect function or performance	Minor
Polarizer bubble	Exceed specified standards	Minor

8. Package Specification

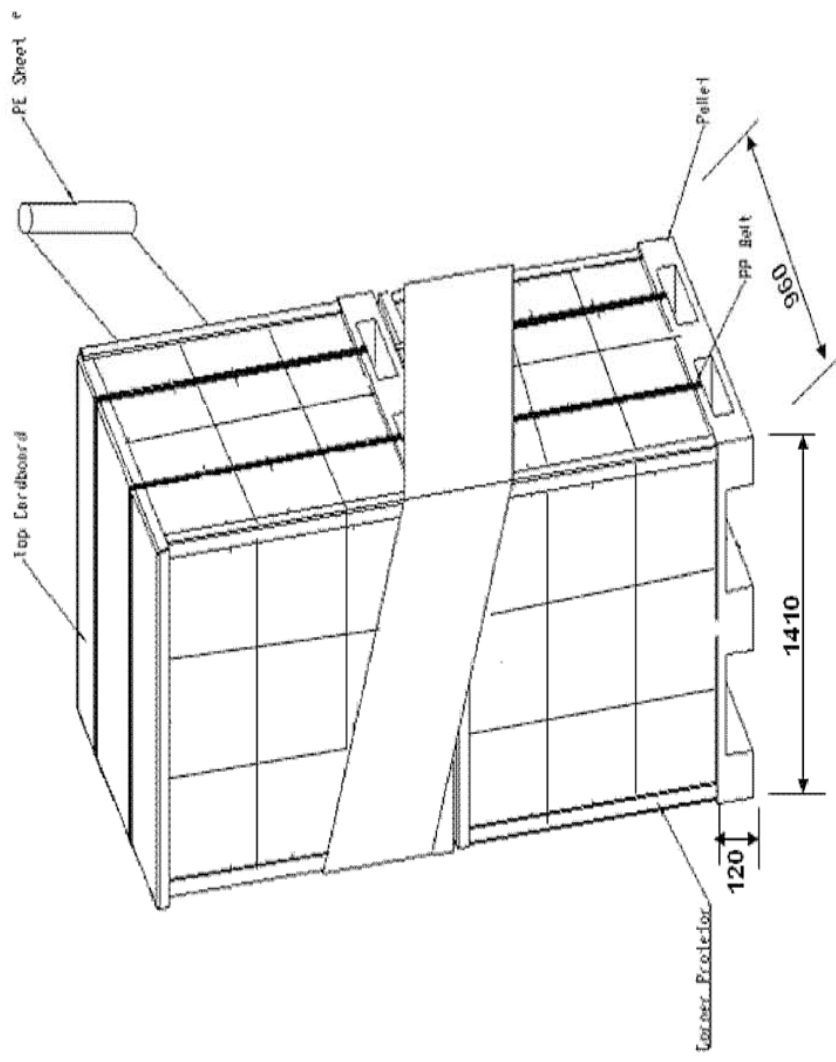
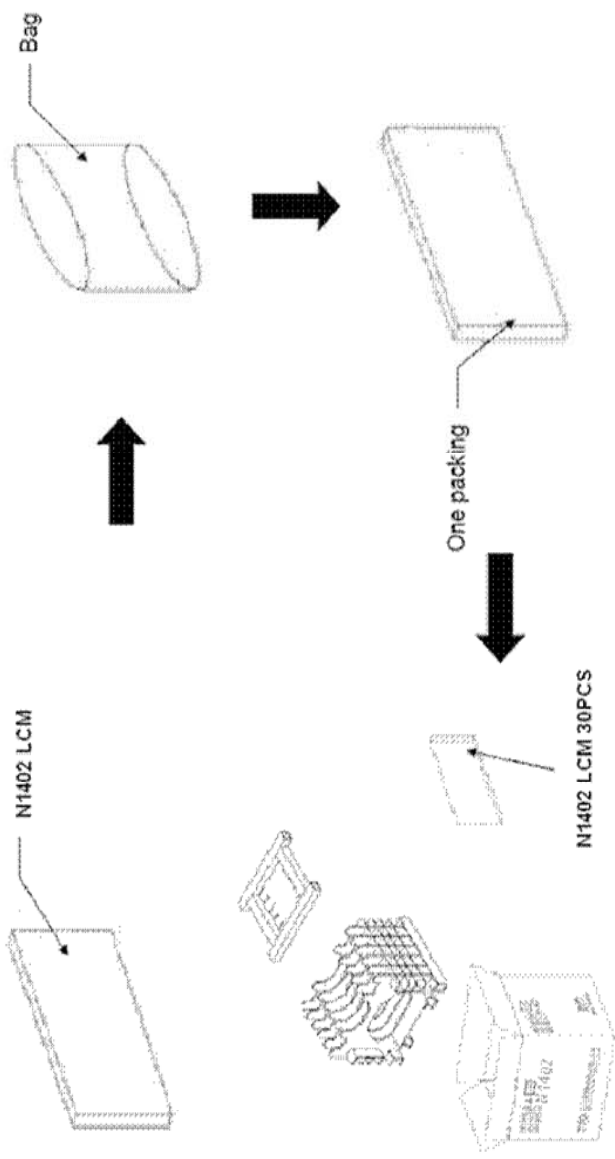

9. Lot Mark

The diagram shows a rectangular label with the following markings and descriptions:

- Module Name:** OPTREX TVL-55684D140U-LW-I-AAN
- Lot Mark:** I1S8EZN1402AA0410002
- RoHS:** R1
- Development Product Name:** HW:1.1 FW:0.0
- H/W: 2nd Source/ Version F/W: EDID Version (NB Product Only):** ZB
- 23 Product Code:** MD14211ACCKS1KS1AA40002
- MADE IN CHINA:** S

9.1 Lot Mark

1	2	3	4	5	6	7	8	9	10	11	12	13	14	15	16	17	18	19	20
---	---	---	---	---	---	---	---	---	----	----	----	----	----	----	----	----	----	----	----

Code 1,2,4,5,6,7,8,9,10,11,16: Internal flow control code.

Code 3: Production Location.

Code 12: Production Year.

Code 13: Production Month.

Code 14,15: Production Date.

Code 17,18,19,20: Serial Number.

Note (1) Production Year

Year	2006	2007	2008	2009	2010	2011	2012	2013	2014	2015
Mark	6	7	8	9	A	B	C	D	E	F

Note (2) Production Month

Month	Jan.	Feb.	Mar.	Apr.	May.	Jun.	Jul.	Aug.	Sep.	Oct.	Nov.	Dec.
Mark	1	2	3	4	5	6	7	8	9	A	B	C

9.2 23 Product Barcode

1	2	3	4	5	6	7	8	9	10	11	12	13	14	15	16	17	18	19	20	21	22	23
---	---	---	---	---	---	---	---	---	----	----	----	----	----	----	----	----	----	----	----	----	----	----

Code 1,2: Manufacture District.

Code 3,4,5,6,7: Internal Module Name.

Code 8,9,10,13,16: Internal Flow Control Code.

Code 11,12: Cell line code "SZ".

Code 14,15: Module line code "KS".

Code 17,18,19: Year, Month, Day Refer to Note(1) and Note(2) of Lot Mark.

Code 20~23: Serial Number.

10. General Precaution

10.1 Use Restriction

This product is not authorized for use in life supporting systems, aircraft navigation control systems, military systems and any other application where performance failure could be life-threatening or otherwise catastrophic.

10.2 Handling Precaution

- 1) Please mount LCD module by using mounting holes arranged in four corners tightly.
- 2) Do not disassemble or modify the module. It may damage sensitive parts inside LCD module, and may cause scratches or dust on the display. KYOCERA Display does not warrant the module, if customers disassemble or modify the module.
- 3) If LCD panel is broken and liquid crystal spills out, do not ingest or inhale liquid crystal, and do not contact liquid crystal with skin. If liquid crystal contacts mouth or eyes, rinse out with water immediately. If liquid crystal contacts skin or cloths, wash it off immediately with alcohol and Rinse thoroughly with water.
- 4) Disconnect power supply before handling LCD module.
- 5) Refrain from strong mechanical shock and /or any force to the module.
- 6) Do not exceed the absolute maximum rating values, such as the supply voltage variation, input voltage variation, variation in parts' parameters, environmental temperature; etc otherwise LCD module may be damaged. It's recommended employing protection circuit for power supply.
- 7) Do not touch, push or rub the polarizer with anything harder than HB pencil lead. Use fingerstalls of soft gloves in order to keep clean display quality, when Persons handle the LCD module for incoming inspection or assembly.
- 8) When the surface is dusty, please wipe gently with absorbent cotton or other soft Material.
When cleaning the adhesives, please use absorbent cotton wetted with a little petroleum benzene or other adequate solvent.
- 9) Wipe off saliva or water drops as soon as possible. If saliva or water drops Contact with polarizer for a long time, they may causes deformation or color Fading.
- 10) Protection film must be removed very slowly from the surface of LCD module to prevent from electrostatic occurrence.
- 11) Because LCD module uses CMOS-IC on circuit board and TFT-LCD panel, it is very weak to electrostatic discharge, Please be careful with electrostatic discharge .Persons who handle the module should be grounded through adequate methods.
- 12) Do not adjust the variable resistor located on the module.

10.3 Storage Precaution

- 1) Please do not leave LCD module in the environment of high humidity and high temperature for a long time.
- 2) The module shall not be exposed under strong light such as direct sunlight. Otherwise, Display characteristics may be changed.
- 3) The module should be stored in a dark place. It is prohibited to apply sunlight or fluorescent light in storage.

10.4 Operation Precaution

- 1) Do not connect or disconnect the module in the "Power On" condition.
- 2) Power supply should always be turned on/off by 9.0 "Power on/off sequence".
- 3) Module has high frequency circuits. Sufficient suppression to the electromagnetic interference should be done by system manufacturers. Grounding and shielding methods may be important to minimize the interference.
- 4) After installation of the TFT Module into an enclosure, do not twist nor bend the TFT Module even momentary. At designing the enclosure, it should be taken into consideration that no bending/twisting forces are applied to the TFT Module from outside.
Otherwise the TFT Module may be damaged.

10.5 Others

- 1) Ultra-violet ray filter is necessary for outdoor operation.
- 2) Avoid condensation of water which may result in improper operation or disconnection of electrode.
- 3) If the module keeps displaying the same pattern for a long period of time, the image may be "Sticked" to the screen.
- 4) This module has its circuitry PCB on the rear side and should be handled carefully in order not to be stressed.

10.6 Disposal

When disposing LCD module, obey the local environmental regulations.



Стандарт Электрон Связь

Мы молодая и активно развивающаяся компания в области поставок электронных компонентов. Мы поставляем электронные компоненты отечественного и импортного производства напрямую от производителей и с крупнейших складов мира.

Благодаря сотрудничеству с мировыми поставщиками мы осуществляем комплексные и плановые поставки широчайшего спектра электронных компонентов.

Собственная эффективная логистика и склад в обеспечивает надежную поставку продукции в точно указанные сроки по всей России.

Мы осуществляем техническую поддержку нашим клиентам и предпродажную проверку качества продукции. На все поставляемые продукты мы предоставляем гарантию .

Осуществляем поставки продукции под контролем ВП МО РФ на предприятия военно-промышленного комплекса России , а также работаем в рамках 275 ФЗ с открытием отдельных счетов в уполномоченном банке. Система менеджмента качества компании соответствует требованиям ГОСТ ISO 9001.

Минимальные сроки поставки, гибкие цены, неограниченный ассортимент и индивидуальный подход к клиентам являются основой для выстраивания долгосрочного и эффективного сотрудничества с предприятиями радиоэлектронной промышленности, предприятиями ВПК и научно-исследовательскими институтами России.

С нами вы становитесь еще успешнее!

Наши контакты:

Телефон: +7 812 627 14 35

Электронная почта: sales@st-electron.ru

Адрес: 198099, Санкт-Петербург,
Промышленная ул, дом № 19, литера Н,
помещение 100-Н Офис 331