

# BD675, BD675A, BD677, BD677A, BD679, BD679A, BD681

BD681 is a Preferred Device

## Plastic Medium-Power Silicon NPN Darlington

This series of plastic, medium-power silicon NPN Darlington transistors can be used as output devices in complementary general-purpose amplifier applications.

### Features

- High DC Current Gain:  

$$h_{FE} = 750 \text{ (Min) @ } I_C$$

$$= 1.5 \text{ and } 2.0 \text{ Adc}$$
- Monolithic Construction
- BD675, 675A, 677, 677A, 679, 679A, 681 are complementary with BD676, 676A, 678, 678A, 680, 680A, 682
- BD677, 677A, 679, 679A are equivalent to MJE 800, 801, 802, 803
- Pb-Free Packages are Available\*

### MAXIMUM RATINGS

| Rating   | Symbol         | Value                 | Unit                     |
|--|----------------|-----------------------|--------------------------|
| Collector-Emitter Voltage<br>BD675, A<br>BD677, A<br>BD679, A<br>BD681                 | $V_{CEO}$      | 45<br>60<br>80<br>100 | Vdc                      |
| Collector-Base Voltage<br>BD675, A<br>BD677, A<br>BD679, A<br>BD681                    | $V_{CBO}$      | 45<br>60<br>80<br>100 | Vdc                      |
| Emitter-Base Voltage   | $V_{EBO}$      | 5.0                   | Vdc                      |
| Collector Current  | $I_C$          | 4.0                   | Adc                      |
| Base Current   | $I_B$          | 1.0                   | Adc                      |
| Total Device Dissipation @ $T_C = 25^\circ\text{C}$<br>Derate above $25^\circ\text{C}$ | $P_D$          | 40<br>0.32            | W<br>W/ $^\circ\text{C}$ |
| Operating and Storage Junction<br>Temperature Range                                    | $T_J, T_{stg}$ | -55 to +150           | $^\circ\text{C}$         |

### THERMAL CHARACTERISTICS

| Characteristic                          | Symbol        | Max  | Unit                      |
|---|---------------|------|---------------------------|
| Thermal Resistance,<br>Junction-to-Case | $\theta_{JC}$ | 3.13 | $^\circ\text{C}/\text{W}$ |

Maximum ratings are those values beyond which device damage can occur. Maximum ratings applied to the device are individual stress limit values (not normal operating conditions) and are not valid simultaneously. If these limits are exceeded, device functional operation is not implied, damage may occur and reliability may be affected.

\*For additional information on our Pb-Free strategy and soldering details, please download the ON Semiconductor Soldering and Mounting Techniques Reference Manual, SOLDERRM/D.



ON Semiconductor®

<http://onsemi.com>

**4.0 AMPERES  
POWER TRANSISTORS  
NPN SILICON  
60, 80, 100 VOLTS, 40 WATTS**

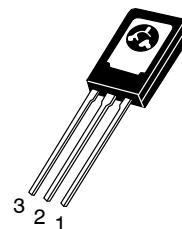
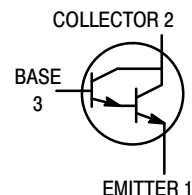

TO-225AA  
CASE 77  
STYLE 1

### MARKING DIAGRAMS

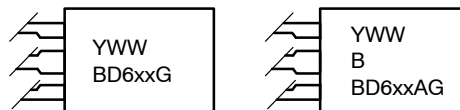

BD6xx = Device Code  
           x = 75, 77, 79, 81  
 Y      = Year  
 WW    = Work Week  
 G      = Pb-Free Package

### ORDERING INFORMATION

See detailed ordering and shipping information in the package dimensions section on page 4 of this data sheet.

Preferred devices are recommended choices for future use and best overall value.

# BD675, BD675A, BD677, BD677A, BD679, BD679A, BD681

## ELECTRICAL CHARACTERISTICS ( $T_C = 25^\circ\text{C}$ unless otherwise noted)

| Characteristic | Symbol | Min | Max | Unit |
|----------------|--------|-----|-----|------|
|----------------|--------|-----|-----|------|

### OFF CHARACTERISTICS

|  |  |            |                       |                  |                 |
|--|--|------------|-----------------------|------------------|-----------------|
| Collector-Emitter Breakdown Voltage, (Note 1)<br>( $I_C = 50 \text{ mAdc}$ , $I_B = 0$ )   | BD675, 675A<br>BD677, 677A<br>BD679, 679A<br>BD681 | $BV_{CEO}$ | 45<br>60<br>80<br>100 | -<br>-<br>-<br>- | Vdc             |
| Collector Cutoff Current ( $V_{CE} = \text{Half Rated } BV_{CEO}$ , $I_B = 0$ )  |  | $I_{CEO}$  | -                     | 500              | $\mu\text{Adc}$ |
| Collector Cutoff Current<br>( $V_{CB} = \text{Rated } BV_{CEO}$ , $I_E = 0$ )<br>( $V_{CB} = \text{Rated } BV_{CEO}$ , $I_E = 0$ , $T_C = 100^\circ\text{C}$ ) |  | $I_{CBO}$  | -<br>-                | 0.2<br>2.0       | mAdc            |
| Emitter Cutoff Current ( $V_{BE} = 5.0 \text{ Vdc}$ , $I_C = 0$ )  |  | $I_{EBO}$  | -                     | 2.0              | mAdc            |

### ON CHARACTERISTICS

|  |  |               |            |            |     |
|--|--|---------------|------------|------------|-----|
| DC Current Gain, (Note 1)<br>( $I_C = 1.5 \text{ Adc}$ , $V_{CE} = 3.0 \text{ Vdc}$ )<br>( $I_C = 2.0 \text{ Adc}$ , $V_{CE} = 3.0 \text{ Vdc}$ )                | BD675, 677, 679, 681<br>BD675A, 677A, 679A | $h_{FE}$      | 750<br>750 | -<br>-     | -   |
| Collector-Emitter Saturation Voltage, (Note 1)<br>( $I_C = 1.5 \text{ Adc}$ , $I_B = 30 \text{ mAdc}$ )<br>( $I_C = 2.0 \text{ Adc}$ , $I_B = 40 \text{ mAdc}$ ) | BD677, 679, 681<br>BD675A, 677A, 679A      | $V_{CE(sat)}$ | -<br>-     | 2.5<br>2.8 | Vdc |
| Base-Emitter On Voltage, (Note 1)<br>( $I_C = 1.5 \text{ Adc}$ , $V_{CE} = 3.0 \text{ Vdc}$ )<br>( $I_C = 2.0 \text{ Adc}$ , $V_{CE} = 3.0 \text{ Vdc}$ )        | BD677, 679, 681<br>BD675A, 677A, 679A      | $V_{BE(on)}$  | -<br>-     | 2.5<br>2.5 | Vdc |

### DYNAMIC CHARACTERISTICS

|  |          |     |   |   |
|--|----------|-----|---|---|
| Small Signal Current Gain ( $I_C = 1.5 \text{ Adc}$ , $V_{CE} = 3.0 \text{ Vdc}$ , $f = 1.0 \text{ MHz}$ ) | $h_{fe}$ | 1.0 | - | - |
|--|----------|-----|---|---|

1. Pulse Test: Pulse Width  $\leq 300 \mu\text{s}$ , Duty Cycle  $\leq 2.0\%$ .

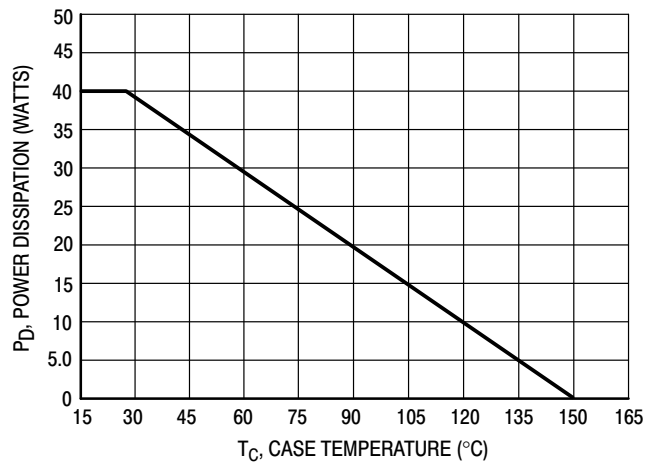

Figure 1. Power Temperature Derating

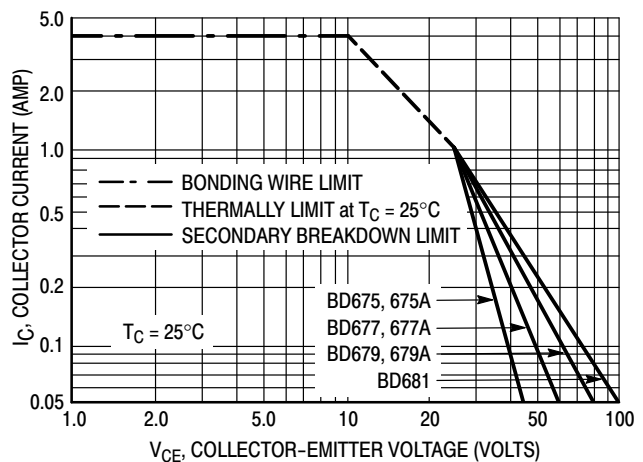

Figure 2. DC Safe Operating Area

There are two limitations on the power handling ability of a transistor average junction temperature and secondary breakdown. Safe operating area curves indicate  $I_C - V_{CE}$  limits of the transistor that must be observed for reliable operation; e.g., the transistor must not be subjected to greater dissipation than the curves indicate.

At high case temperatures, thermal limitations will reduce the power that can be handled to values less than the limitations imposed by secondary breakdown.

# BD675, BD675A, BD677, BD677A, BD679, BD679A, BD681

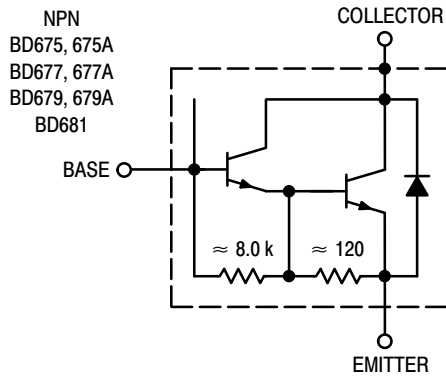

Figure 3. Darlington Circuit Schematic

## ORDERING INFORMATION

| Device  | Package               | Shipping        |
|---------|-----------------------|-----------------|
| BD675   | TO-225AA              | 500 Units / Box |
| BD675G  | TO-225AA<br>(Pb-Free) | 500 Units / Box |
| BD675A  | TO-225AA              | 500 Units / Box |
| BD675AG | TO-225AA<br>(Pb-Free) | 500 Units / Box |
| BD677   | TO-225AA              | 500 Units / Box |
| BD677G  | TO-225AA<br>(Pb-Free) | 500 Units / Box |
| BD677A  | TO-225AA              | 500 Units / Box |
| BD677AG | TO-225AA<br>(Pb-Free) | 500 Units / Box |
| BD679   | TO-225AA              | 500 Units / Box |
| BD679G  | TO-225AA<br>(Pb-Free) | 500 Units / Box |
| BD679A  | TO-225AA              | 500 Units / Box |
| BD679AG | TO-225AA<br>(Pb-Free) | 500 Units / Box |
| BD681   | TO-225AA              | 500 Units / Box |
| BD681G  | TO-225AA<br>(Pb-Free) | 500 Units / Box |

# BD675, BD675A, BD677, BD677A, BD679, BD679A, BD681

## PACKAGE DIMENSIONS

TO-225AA  
CASE 77-09  
ISSUE Z

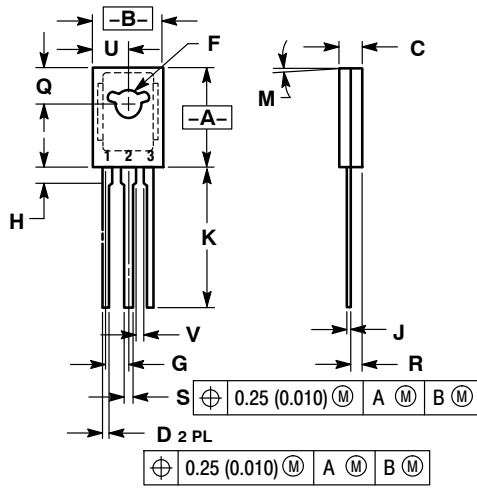

NOTES:

1. DIMENSIONING AND TOLERANCING PER ANSI Y14.5M, 1982.
2. CONTROLLING DIMENSION: INCH.
3. 077-01 THRU -08 OBSOLETE, NEW STANDARD 077-09.

| DIM | INCHES    |       | MILLIMETERS |       |
|-----|-----------|-------|-------------|-------|
|     | MIN       | MAX   | MIN         | MAX   |
| A   | 0.425     | 0.435 | 10.80       | 11.04 |
| B   | 0.295     | 0.305 | 7.50        | 7.74  |
| C   | 0.095     | 0.105 | 2.42        | 2.66  |
| D   | 0.020     | 0.026 | 0.51        | 0.66  |
| F   | 0.115     | 0.130 | 2.93        | 3.30  |
| G   | 0.094 BSC |       | 2.39 BSC    |       |
| H   | 0.050     | 0.095 | 1.27        | 2.41  |
| J   | 0.015     | 0.025 | 0.39        | 0.63  |
| K   | 0.575     | 0.655 | 14.61       | 16.63 |
| M   | 5° TYP    |       | 5° TYP      |       |
| Q   | 0.148     | 0.158 | 3.76        | 4.01  |
| R   | 0.045     | 0.065 | 1.15        | 1.65  |
| S   | 0.025     | 0.035 | 0.64        | 0.88  |
| U   | 0.145     | 0.155 | 3.69        | 3.93  |
| V   | 0.040     | ---   | 1.02        | ---   |

STYLE 1:

- PIN 1. EMITTER
2. COLLECTOR
3. BASE

ON Semiconductor and are registered trademarks of Semiconductor Components Industries, LLC (SCILLC). SCILLC reserves the right to make changes without further notice to any products herein. SCILLC makes no warranty, representation or guarantee regarding the suitability of its products for any particular purpose, nor does SCILLC assume any liability arising out of the application or use of any product or circuit, and specifically disclaims any and all liability, including without limitation special, consequential or incidental damages. "Typical" parameters which may be provided in SCILLC data sheets and/or specifications can and do vary in different applications and actual performance may vary over time. All operating parameters, including "Typicals" must be validated for each customer application by customer's technical experts. SCILLC does not convey any license under its patent rights nor the rights of others. SCILLC products are not designed, intended, or authorized for use as components in systems intended for surgical implant into the body, or other applications intended to support or sustain life, or for any other application in which the failure of the SCILLC product could create a situation where personal injury or death may occur. Should Buyer purchase or use SCILLC products for any such unintended or unauthorized application, Buyer shall indemnify and hold SCILLC and its officers, employees, subsidiaries, affiliates, and distributors harmless against all claims, costs, damages, and expenses, and reasonable attorney fees arising out of, directly or indirectly, any claim of personal injury or death associated with such unintended or unauthorized use, even if such claim alleges that SCILLC was negligent regarding the design or manufacture of the part. SCILLC is an Equal Opportunity/Affirmative Action Employer. This literature is subject to all applicable copyright laws and is not for resale in any manner.

### PUBLICATION ORDERING INFORMATION

**LITERATURE FULFILLMENT:**

Literature Distribution Center for ON Semiconductor  
P.O. Box 5163, Denver, Colorado 80217 USA  
Phone: 303-675-2175 or 800-344-3860 Toll Free USA/Canada  
Fax: 303-675-2176 or 800-344-3867 Toll Free USA/Canada  
Email: orderlit@onsemi.com

**N. American Technical Support:** 800-282-9855 Toll Free USA/Canada  
**Europe, Middle East and Africa Technical Support:**  
Phone: 421 33 790 2910  
**Japan Customer Focus Center**  
Phone: 81-3-5773-3850

**ON Semiconductor Website:** [www.onsemi.com](http://www.onsemi.com)  
**Order Literature:** <http://www.onsemi.com/orderlit>  
For additional information, please contact your local Sales Representative



## Стандарт Электрон Связь

Мы молодая и активно развивающаяся компания в области поставок электронных компонентов. Мы поставляем электронные компоненты отечественного и импортного производства напрямую от производителей и с крупнейших складов мира.

Благодаря сотрудничеству с мировыми поставщиками мы осуществляем комплексные и плановые поставки широчайшего спектра электронных компонентов.

Собственная эффективная логистика и склад в обеспечивает надежную поставку продукции в точно указанные сроки по всей России.

Мы осуществляем техническую поддержку нашим клиентам и предпродажную проверку качества продукции. На все поставляемые продукты мы предоставляем гарантию .

Осуществляем поставки продукции под контролем ВП МО РФ на предприятия военно-промышленного комплекса России , а также работаем в рамках 275 ФЗ с открытием отдельных счетов в уполномоченном банке. Система менеджмента качества компании соответствует требованиям ГОСТ ISO 9001.

Минимальные сроки поставки, гибкие цены, неограниченный ассортимент и индивидуальный подход к клиентам являются основой для выстраивания долгосрочного и эффективного сотрудничества с предприятиями радиоэлектронной промышленности, предприятиями ВПК и научно-исследовательскими институтами России.

С нами вы становитесь еще успешнее!

### Наши контакты:

**Телефон:** +7 812 627 14 35

**Электронная почта:** [sales@st-electron.ru](mailto:sales@st-electron.ru)

**Адрес:** 198099, Санкт-Петербург,  
Промышленная ул, дом № 19, литера Н,  
помещение 100-Н Офис 331