

# BDX53B, BDX53C (NPN), BDX54B, BDX54C (PNP)

## Plastic Medium-Power Complementary Silicon Transistors

These devices are designed for general-purpose amplifier and low-speed switching applications.

### Features

- High DC Current Gain –  
 $h_{FE} = 2500$  (Typ) @  $I_C = 4.0$  Adc
- Collector Emitter Sustaining Voltage – @ 100 mAdc  
 $V_{CEO(sus)} = 80$  Vdc (Min) – BDX53B, 54B  
 $= 100$  Vdc (Min) – BDX53C, 54C
- Low Collector–Emitter Saturation Voltage –  
 $V_{CE(sat)} = 2.0$  Vdc (Max) @  $I_C = 3.0$  Adc  
 $= 4.0$  Vdc (Max) @  $I_C = 5.0$  Adc
- Monolithic Construction with Built-In Base–Emitter Shunt Resistors
- Pb–Free Packages are Available\*

### MAXIMUM RATINGS

| Rating   | Symbol         | Value       | Unit                     |
|--|----------------|-------------|--------------------------|
| Collector–Emitter Voltage<br>BDX53B, BDX54B<br>BDX53C, BDX54C                          | $V_{CEO}$      | 80<br>100   | Vdc                      |
| Collector–Base Voltage<br>BDX53B, BDX54B<br>BDX53C, BDX54C                             | $V_{CB}$       | 80<br>100   | Vdc                      |
| Emitter–Base Voltage   | $V_{EB}$       | 5.0         | Vdc                      |
| Collector Current – Continuous<br>– Peak   | $I_C$          | 8.0<br>12   | Adc                      |
| Base Current   | $I_B$          | 0.2         | Adc                      |
| Total Device Dissipation @ $T_C = 25^\circ\text{C}$<br>Derate above $25^\circ\text{C}$ | $P_D$          | 65<br>0.48  | W<br>W/ $^\circ\text{C}$ |
| Operating and Storage Junction<br>Temperature Range                                    | $T_J, T_{stg}$ | –65 to +150 | $^\circ\text{C}$         |

### THERMAL CHARACTERISTICS

| Characteristic                          | Symbol          | Max  | Unit                      |
|---|-----------------|------|---------------------------|
| Thermal Resistance, Junction–to–Ambient | $R_{\theta JA}$ | 70   | $^\circ\text{C}/\text{W}$ |
| Thermal Resistance, Junction–to–Case    | $R_{\theta JC}$ | 1.92 | $^\circ\text{C}/\text{W}$ |

Stresses exceeding Maximum Ratings may damage the device. Maximum Ratings are stress ratings only. Functional operation above the Recommended Operating Conditions is not implied. Extended exposure to stresses above the Recommended Operating Conditions may affect device reliability.

\*For additional information on our Pb–Free strategy and soldering details, please download the ON Semiconductor Soldering and Mounting Techniques Reference Manual, SOLDERRM/D.



ON Semiconductor®

<http://onsemi.com>

## DARLINGTON 8 AMPERE COMPLEMENTARY SILICON POWER TRANSISTORS 80–100 VOLTS, 65 WATTS

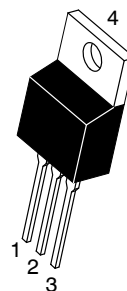

TO–220AB  
CASE 221A  
STYLE 1

### MARKING DIAGRAM & PIN ASSIGNMENT

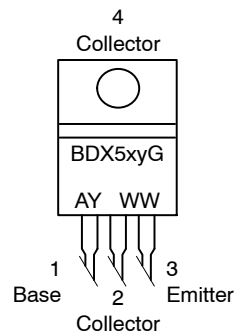

BDX5xy = Device Code  
x = 3 or 4  
y = B or C  
A = Assembly Location  
Y = Year  
WW = Work Week  
G = Pb–Free Package

### ORDERING INFORMATION

See detailed ordering and shipping information in the package dimensions section on page 6 of this data sheet.

## BDX53B, BDX53C (NPN), BDX54B, BDX54C (PNP)

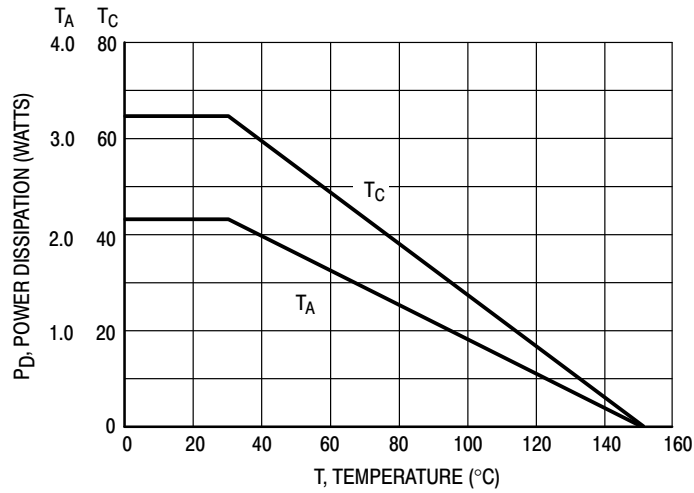

**Figure 1. Power Derating**

### ELECTRICAL CHARACTERISTICS ( $T_C = 25^\circ\text{C}$ unless otherwise noted)

| Characteristic  | Symbol                           | Min            | Max        | Unit       |      |
|---|----------------------------------|----------------|------------|------------|------|
| <b>OFF CHARACTERISTICS</b>  |                                  |                |            |            |      |
| Collector-Emitter Sustaining Voltage (Note 1)<br>( $I_C = 100\text{ mAdc}$ , $I_B = 0$ )                          | BDX53B, BDX54B<br>BDX53C, BDX54C | $V_{CEO(sus)}$ | 80<br>100  | -<br>-     | Vdc  |
| Collector Cutoff Current<br>( $V_{CE} = 40\text{ Vdc}$ , $I_B = 0$ )<br>( $V_{CE} = 50\text{ Vdc}$ , $I_B = 0$ )  | BDX53B, BDX54B<br>BDX53C, BDX54C | $I_{CEO}$      | -<br>-     | 0.5<br>0.5 | mAdc |
| Collector Cutoff Current<br>( $V_{CB} = 80\text{ Vdc}$ , $I_E = 0$ )<br>( $V_{CB} = 100\text{ Vdc}$ , $I_E = 0$ ) | BDX53B, BDX54B<br>BDX53C, BDX54C | $I_{CBO}$      | -<br>-     | 0.2<br>0.2 | mAdc |
| <b>ON CHARACTERISTICS (Note 1)</b>  |                                  |                |            |            |      |
| DC Current Gain<br>( $I_C = 3.0\text{ Adc}$ , $V_{CE} = 3.0\text{ Vdc}$ )   | $h_{FE}$                         | 750            | -          | -          |      |
| Collector-Emitter Saturation Voltage<br>( $I_C = 3.0\text{ Adc}$ , $I_B = 12\text{ mAdc}$ )                       | $V_{CE(sat)}$                    | -              | 2.0<br>4.0 | -          | Vdc  |
| Base-Emitter Saturation Voltage<br>( $I_C = 3.0\text{ Adc}$ , $I_C = 12\text{ mA}$ )                              | $V_{BE(sat)}$                    | -              | 2.5        | -          | Vdc  |
| <b>DYNAMIC CHARACTERISTICS</b>  |                                  |                |            |            |      |
| Small-Signal Current Gain<br>( $I_C = 3.0\text{ Adc}$ , $V_{CE} = 4.0\text{ Vdc}$ , $f = 1.0\text{ MHz}$ )        | $h_{fe}$                         | 4.0            | -          | -          |      |
| Output Capacitance<br>( $V_{CB} = 10\text{ Vdc}$ , $I_E = 0$ , $f = 0.1\text{ MHz}$ )                             | BDX53B, 53C<br>BDX54B, 54C       | $C_{ob}$       | -          | 300<br>200 | pF   |

1. Pulse Test: Pulse Width  $\leq 300\ \mu\text{s}$ , Duty Cycle  $\leq 2\%$ .

## BDX53B, BDX53C (NPN), BDX54B, BDX54C (PNP)

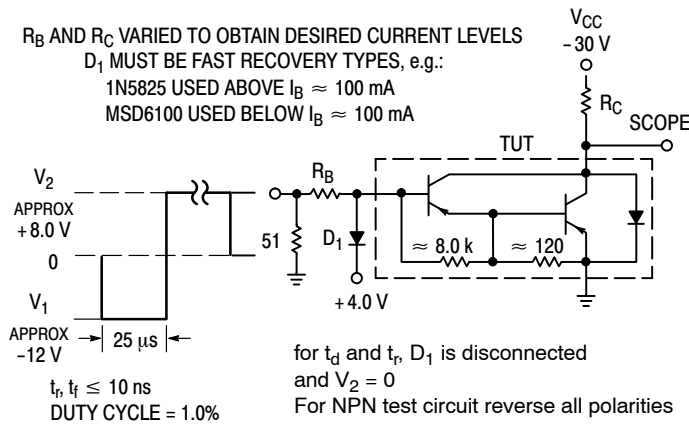

**Figure 2. Switching Time Test Circuit**

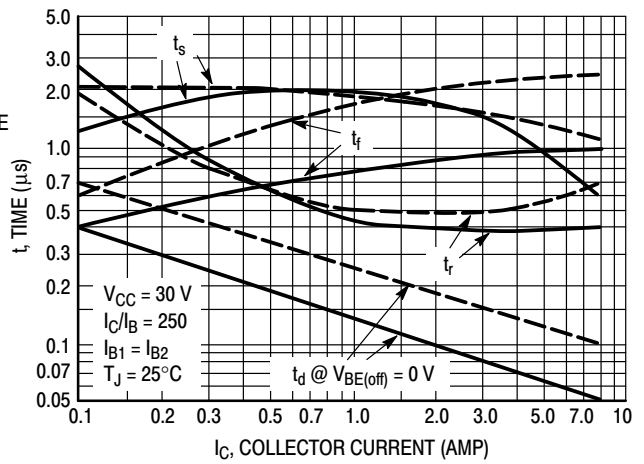

**Figure 3. Switching Times**

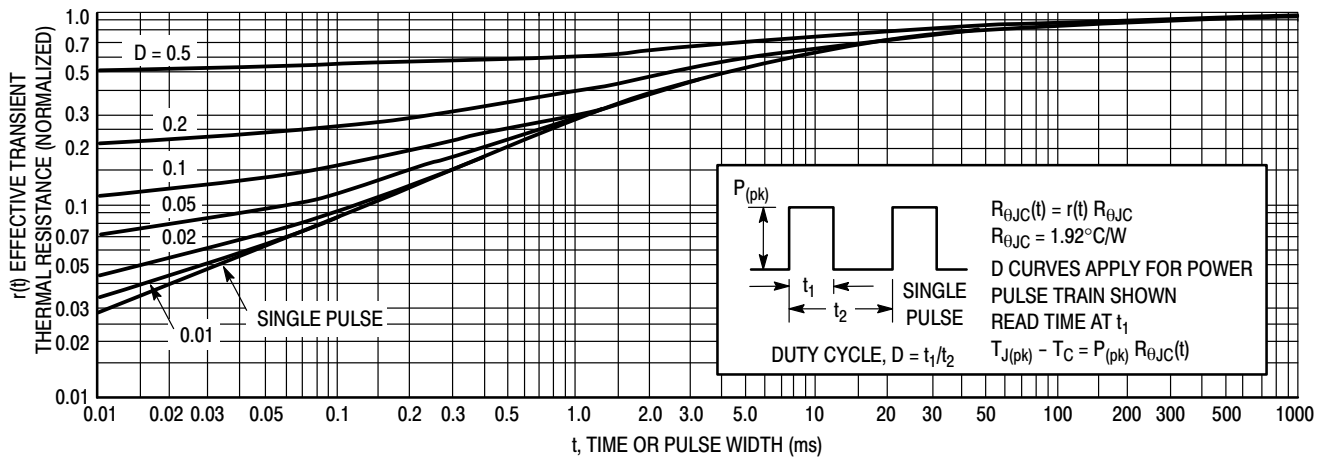

**Figure 4. Thermal Response**

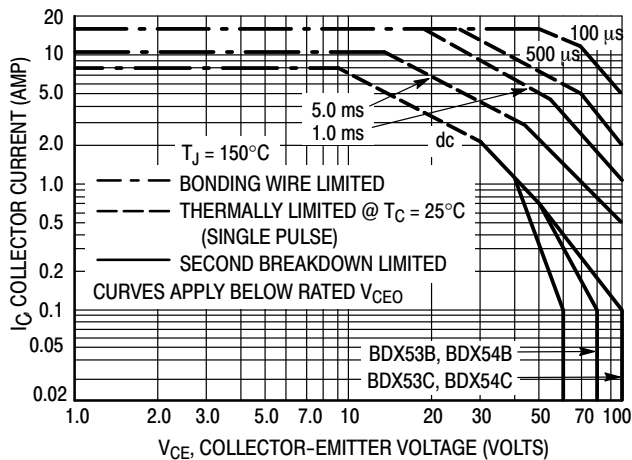

**Figure 5. Active-Region Safe Operating Area**

There are two limitations on the power handling ability of a transistor average junction temperature and second breakdown. Safe operating area curves indicate  $I_C - V_{CE}$  limits of the transistor that must be observed for reliable operation, i.e., the transistor must not be subjected to greater dissipation than the curves indicate.

The data of Figure 5 is based on  $T_{J(pk)} = 150^\circ\text{C}$ ;  $T_C$  is variable depending on conditions. Second breakdown pulse limits are valid for duty cycles to 10% provided  $T_{J(pk)} < 150^\circ\text{C}$ .  $T_{J(pk)}$  may be calculated from the data in Figure 4. At high case temperatures, thermal limitations will reduce the power that can be handled to values less than the limitations imposed by second breakdown.

# BDX53B, BDX53C (NPN), BDX54B, BDX54C (PNP)

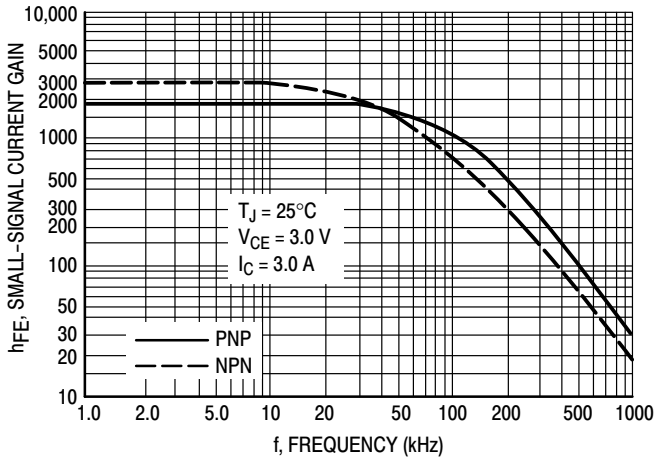

Figure 6. Small-Signal Current Gain

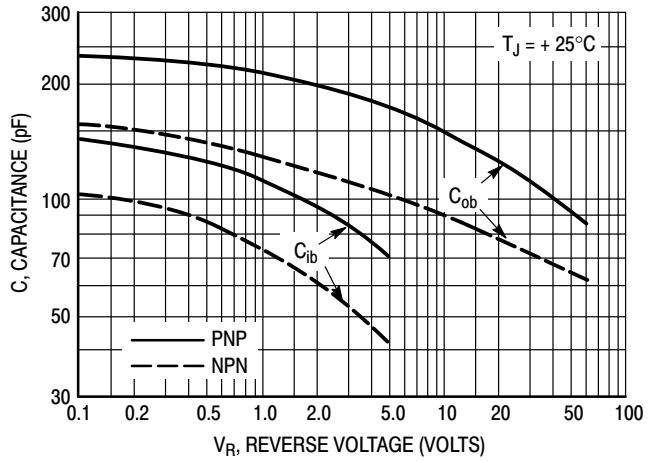
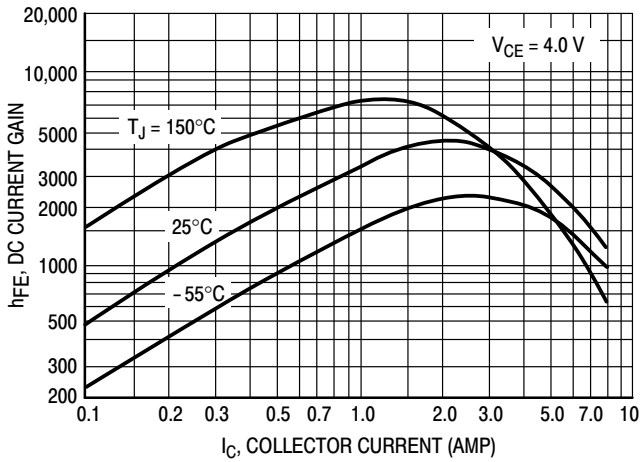

Figure 7. Capacitance

**NPN**  
**BDX53B, 53C**



**PNP**  
**BDX54B, 54C**

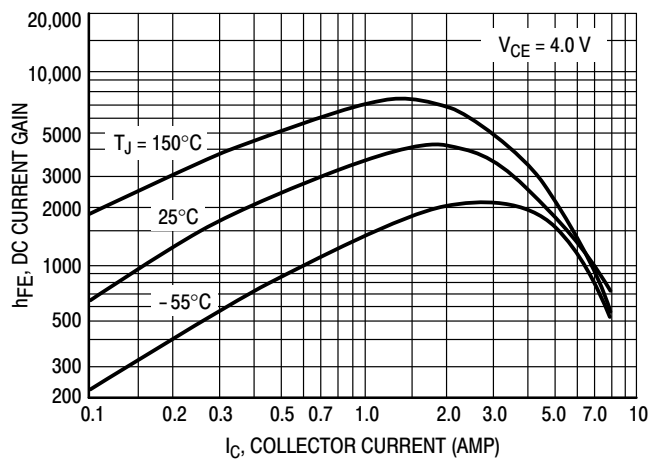

Figure 8. DC Current Gain

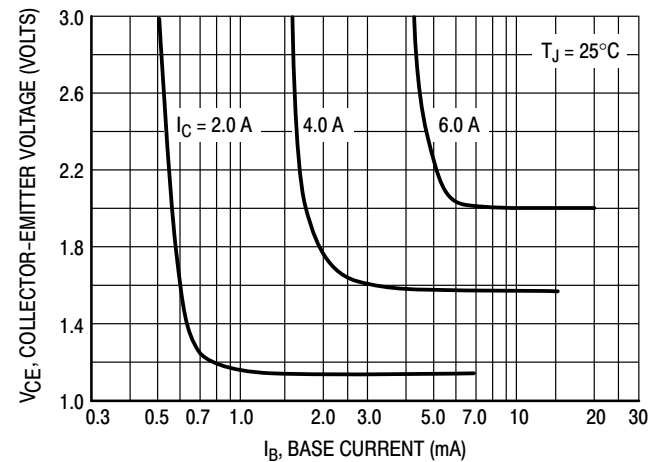
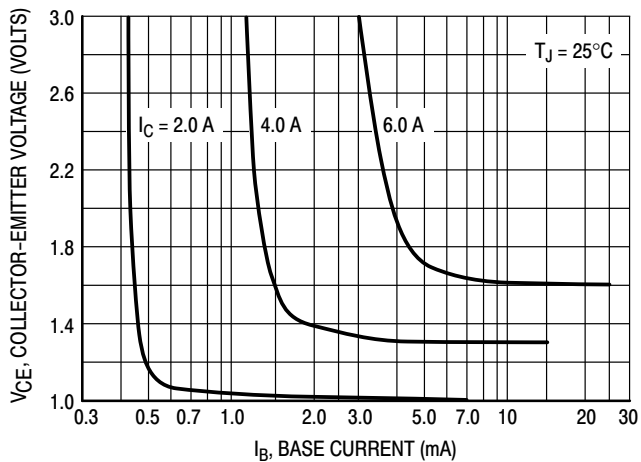

Figure 9. Collector Saturation Region

## BDX53B, BDX53C (NPN), BDX54B, BDX54C (PNP)

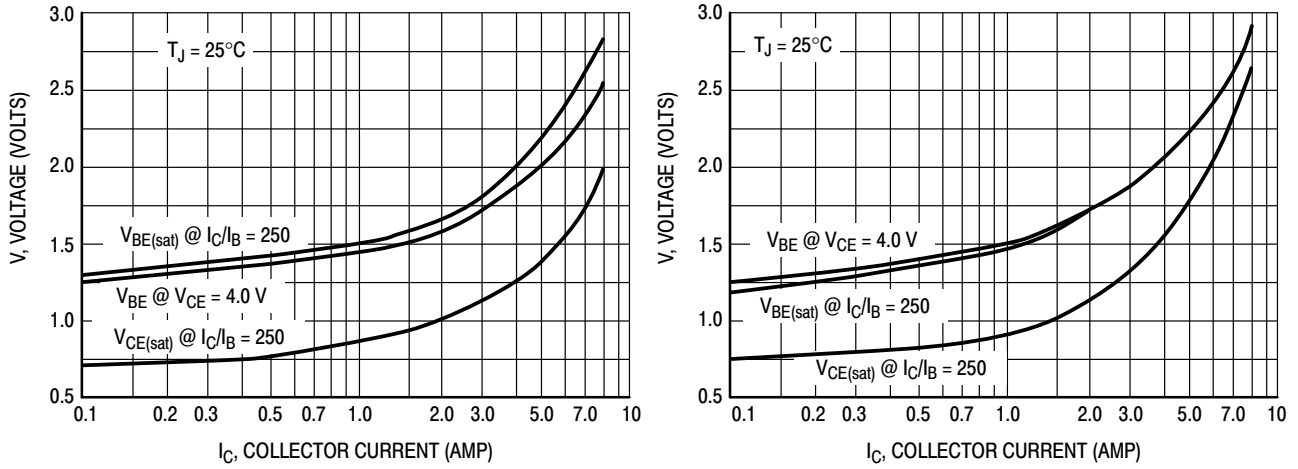

Figure 10. "On" Voltages

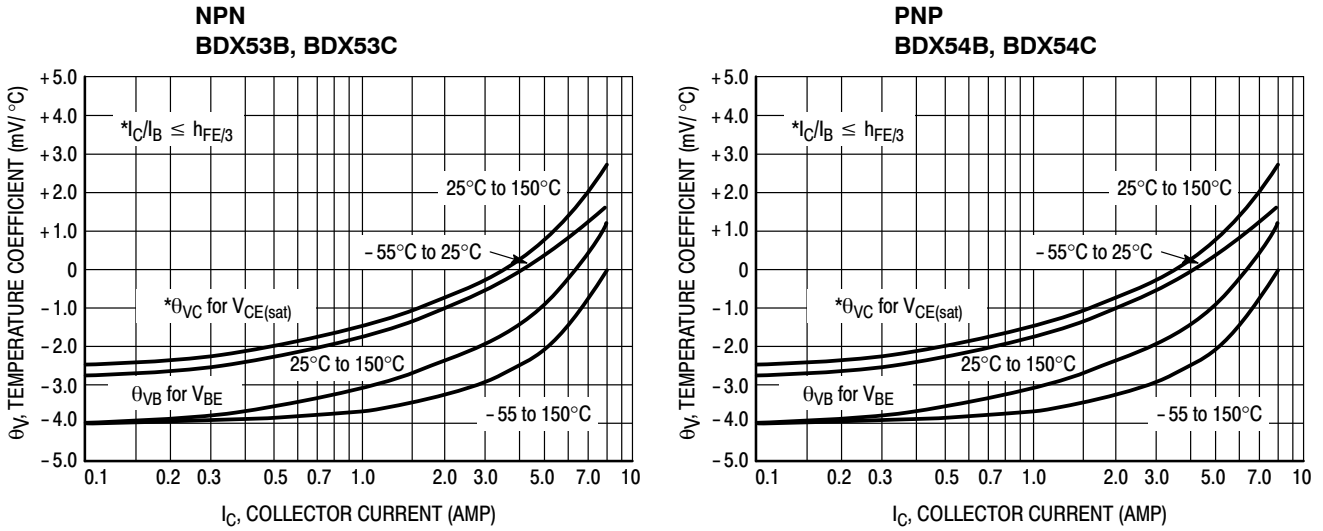

Figure 11. Temperature Coefficients

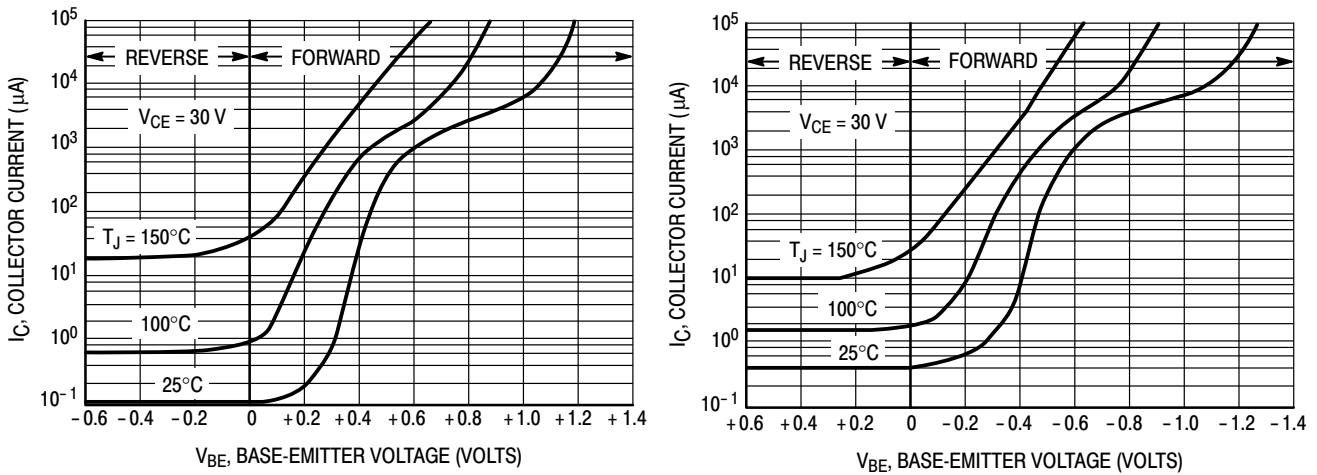

Figure 12. Collector Cut-Off Region

## BDX53B, BDX53C (NPN), BDX54B, BDX54C (PNP)



**Figure 13. Darlington Schematic**

### ORDERING INFORMATION

| Device  | Package             | Shipping <sup>†</sup> |
|---------|---------------------|-----------------------|
| BDX53B  | TO-220              | 50 Units / Rail       |
| BDX53BG | TO-220<br>(Pb-Free) |                       |
| BDX53C  | TO-220              | 50 Units / Rail       |
| BDX53CG | TO-220<br>(Pb-Free) |                       |
| BDX54B  | TO-220              | 50 Units / Rail       |
| BDX54BG | TO-220<br>(Pb-Free) |                       |
| BDX54C  | TO-220              | 50 Units / Rail       |
| BDX54CG | TO-220<br>(Pb-Free) |                       |

<sup>†</sup>For information on tape and reel specifications, including part orientation and tape sizes, please refer to our Tape and Reel Packaging Specifications Brochure, BRD8011/D.

# BDX53B, BDX53C (NPN), BDX54B, BDX54C (PNP)

## PACKAGE DIMENSIONS

### TO-220 CASE 221A-09 ISSUE AG

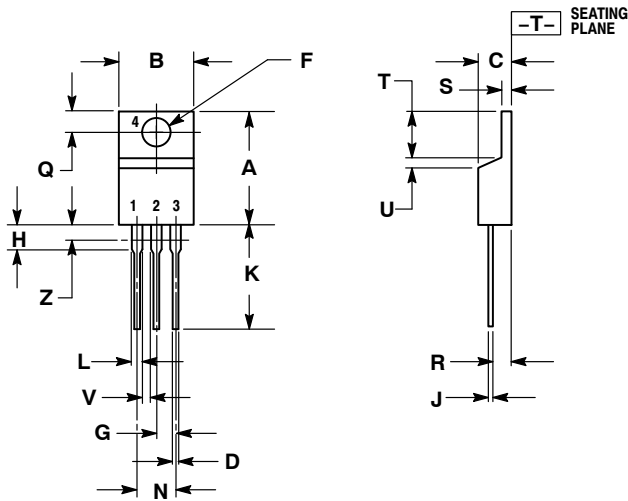

#### NOTES:

1. DIMENSIONING AND TOLERANCING PER ANSI Y14.5M, 1982.
2. CONTROLLING DIMENSION: INCH.
3. DIMENSION Z DEFINES A ZONE WHERE ALL BODY AND LEAD IRREGULARITIES ARE ALLOWED.

| DIM | INCHES |       | MILLIMETERS |       |
|-----|--------|-------|-------------|-------|
|     | MIN    | MAX   | MIN         | MAX   |
| A   | 0.570  | 0.620 | 14.48       | 15.75 |
| B   | 0.380  | 0.405 | 9.66        | 10.28 |
| C   | 0.160  | 0.190 | 4.07        | 4.82  |
| D   | 0.025  | 0.036 | 0.64        | 0.91  |
| F   | 0.142  | 0.161 | 3.61        | 4.09  |
| G   | 0.095  | 0.105 | 2.42        | 2.66  |
| H   | 0.110  | 0.161 | 2.80        | 4.10  |
| J   | 0.014  | 0.025 | 0.36        | 0.64  |
| K   | 0.500  | 0.562 | 12.70       | 14.27 |
| L   | 0.045  | 0.060 | 1.15        | 1.52  |
| N   | 0.190  | 0.210 | 4.83        | 5.33  |
| Q   | 0.100  | 0.120 | 2.54        | 3.04  |
| R   | 0.080  | 0.110 | 2.04        | 2.79  |
| S   | 0.045  | 0.055 | 1.15        | 1.39  |
| T   | 0.235  | 0.255 | 5.97        | 6.47  |
| U   | 0.000  | 0.050 | 0.00        | 1.27  |
| V   | 0.045  | ---   | 1.15        | ---   |
| Z   | ---    | 0.080 | ---         | 2.04  |

#### STYLE 1:

- PIN 1. BASE
- 2. COLLECTOR
- 3. EMITTER
- 4. COLLECTOR

ON Semiconductor and  are registered trademarks of Semiconductor Components Industries, LLC (SCILLC). SCILLC reserves the right to make changes without further notice to any products herein. SCILLC makes no warranty, representation or guarantee regarding the suitability of its products for any particular purpose, nor does SCILLC assume any liability arising out of the application or use of any product or circuit, and specifically disclaims any and all liability, including without limitation special, consequential or incidental damages. "Typical" parameters which may be provided in SCILLC data sheets and/or specifications can and do vary in different applications and actual performance may vary over time. All operating parameters, including "Typicals" must be validated for each customer application by customer's technical experts. SCILLC does not convey any license under its patent rights nor the rights of others. SCILLC products are not designed, intended, or authorized for use as components in systems intended for surgical implant into the body, or other applications intended to support or sustain life, or for any other application in which the failure of the SCILLC product could create a situation where personal injury or death may occur. Should Buyer purchase or use SCILLC products for any such unintended or unauthorized application, Buyer shall indemnify and hold SCILLC and its officers, employees, subsidiaries, affiliates, and distributors harmless against all claims, costs, damages, and expenses, and reasonable attorney fees arising out of, directly or indirectly, any claim of personal injury or death associated with such unintended or unauthorized use, even if such claim alleges that SCILLC was negligent regarding the design or manufacture of the part. SCILLC is an Equal Opportunity/Affirmative Action Employer. This literature is subject to all applicable copyright laws and is not for resale in any manner.

### PUBLICATION ORDERING INFORMATION

#### LITERATURE FULFILLMENT:

Literature Distribution Center for ON Semiconductor  
P.O. Box 5163, Denver, Colorado 80217 USA  
Phone: 303-675-2175 or 800-344-3860 Toll Free USA/Canada  
Fax: 303-675-2176 or 800-344-3867 Toll Free USA/Canada  
Email: orderlit@onsemi.com

**N. American Technical Support:** 800-282-9855 Toll Free  
USA/Canada  
**Europe, Middle East and Africa Technical Support:**  
Phone: 421 33 790 2910  
**Japan Customer Focus Center**  
Phone: 81-3-5817-1050

**ON Semiconductor Website:** [www.onsemi.com](http://www.onsemi.com)

**Order Literature:** <http://www.onsemi.com/orderlit>

For additional information, please contact your local Sales Representative



## Стандарт Электрон Связь

Мы молодая и активно развивающаяся компания в области поставок электронных компонентов. Мы поставляем электронные компоненты отечественного и импортного производства напрямую от производителей и с крупнейших складов мира.

Благодаря сотрудничеству с мировыми поставщиками мы осуществляем комплексные и плановые поставки широчайшего спектра электронных компонентов.

Собственная эффективная логистика и склад в обеспечивает надежную поставку продукции в точно указанные сроки по всей России.

Мы осуществляем техническую поддержку нашим клиентам и предпродажную проверку качества продукции. На все поставляемые продукты мы предоставляем гарантию .

Осуществляем поставки продукции под контролем ВП МО РФ на предприятия военно-промышленного комплекса России , а также работаем в рамках 275 ФЗ с открытием отдельных счетов в уполномоченном банке. Система менеджмента качества компании соответствует требованиям ГОСТ ISO 9001.

Минимальные сроки поставки, гибкие цены, неограниченный ассортимент и индивидуальный подход к клиентам являются основой для выстраивания долгосрочного и эффективного сотрудничества с предприятиями радиоэлектронной промышленности, предприятиями ВПК и научно-исследовательскими институтами России.

С нами вы становитесь еще успешнее!

### Наши контакты:

**Телефон:** +7 812 627 14 35

**Электронная почта:** [sales@st-electron.ru](mailto:sales@st-electron.ru)

**Адрес:** 198099, Санкт-Петербург,  
Промышленная ул, дом № 19, литера Н,  
помещение 100-Н Офис 331