



# 128K x 32, 128K x 36, 256K x 18 4 Mb SYNCHRONOUS PIPELINED, SINGLE CYCLE DESELECT STATIC RAM

JANUARY 2010

## FEATURES

- Internal self-timed write cycle
- Individual Byte Write Control and Global Write
- Clock controlled, registered address, data and control
- Burst sequence control using MODE input
- Three chip enable option for simple depth expansion and address pipelining
- Common data inputs and data outputs
- Auto Power-down during deselect
- Single cycle deselect
- Snooze MODE for reduced-power standby
- Power Supply  
LPS:  $V_{DD} 3.3V \pm 5\%$ ,  $V_{DDQ} 3.3V/2.5V \pm 5\%$   
VPS:  $V_{DD} 2.5V \pm 5\%$ ,  $V_{DDQ} 2.5V \pm 5\%$
- JEDEC 100-Pin TQFP, 119-ball PBGA, and 165-ball PBGA packages
- Automotive temperature available
- Lead Free available

## DESCRIPTION

The *ISSI* IS61(64)LPS12832A, IS61(64)LPS/VPS12836A and IS61(64)LPS/VPS25618A are high-speed, low-power synchronous static RAMs designed to provide burstable, high-performance memory for communication and networking applications. The IS61(64)LPS12832A is organized as 131,072 words by 32 bits. The IS61(64)LPS/VPS12836A is organized as 131,072 words by 36 bits. The IS61(64)LPS/VPS25618A is organized as 262,144 words by 18 bits. Fabricated with *ISSI*'s advanced CMOS technology, the device integrates a 2-bit burst counter, high-speed SRAM core, and high-drive capability outputs into a single monolithic circuit. All synchronous inputs pass through registers controlled by a positive-edge-triggered single clock input.

Write cycles are internally self-timed and are initiated by the rising edge of the clock input. Write cycles can be one to four bytes wide as controlled by the write control inputs.

Separate byte enables allow individual bytes to be written. The byte write operation is performed by using the byte write enable ( $\overline{BWE}$ ) input combined with one or more individual byte write signals ( $\overline{BWx}$ ). In addition, Global Write ( $\overline{GW}$ ) is available for writing all bytes at one time, regardless of the byte write controls.

Bursts can be initiated with either  $\overline{ADSP}$  (Address Status Processor) or  $\overline{ADSC}$  (Address Status Cache Controller) input pins. Subsequent burst addresses can be generated internally and controlled by the  $\overline{ADV}$  (burst address advance) input pin.

The mode pin is used to select the burst sequence order. Linear burst is achieved when this pin is tied LOW. Interleave burst is achieved when this pin is tied HIGH or left floating.

## FAST ACCESS TIME

Symbol	Parameter	250	200	Units
tkQ	Clock Access Time	2.6	3.1	ns
tkC	Cycle Time	4	5	ns
	Frequency	250	200	MHz

Copyright © 2006 Integrated Silicon Solution, Inc. All rights reserved. ISSI reserves the right to make changes to this specification and its products at any time without notice. ISSI assumes no liability arising out of the application or use of any information, products or services described herein. Customers are advised to obtain the latest version of this device specification before relying on any published information and before placing orders for products.

**BLOCK DIAGRAM**

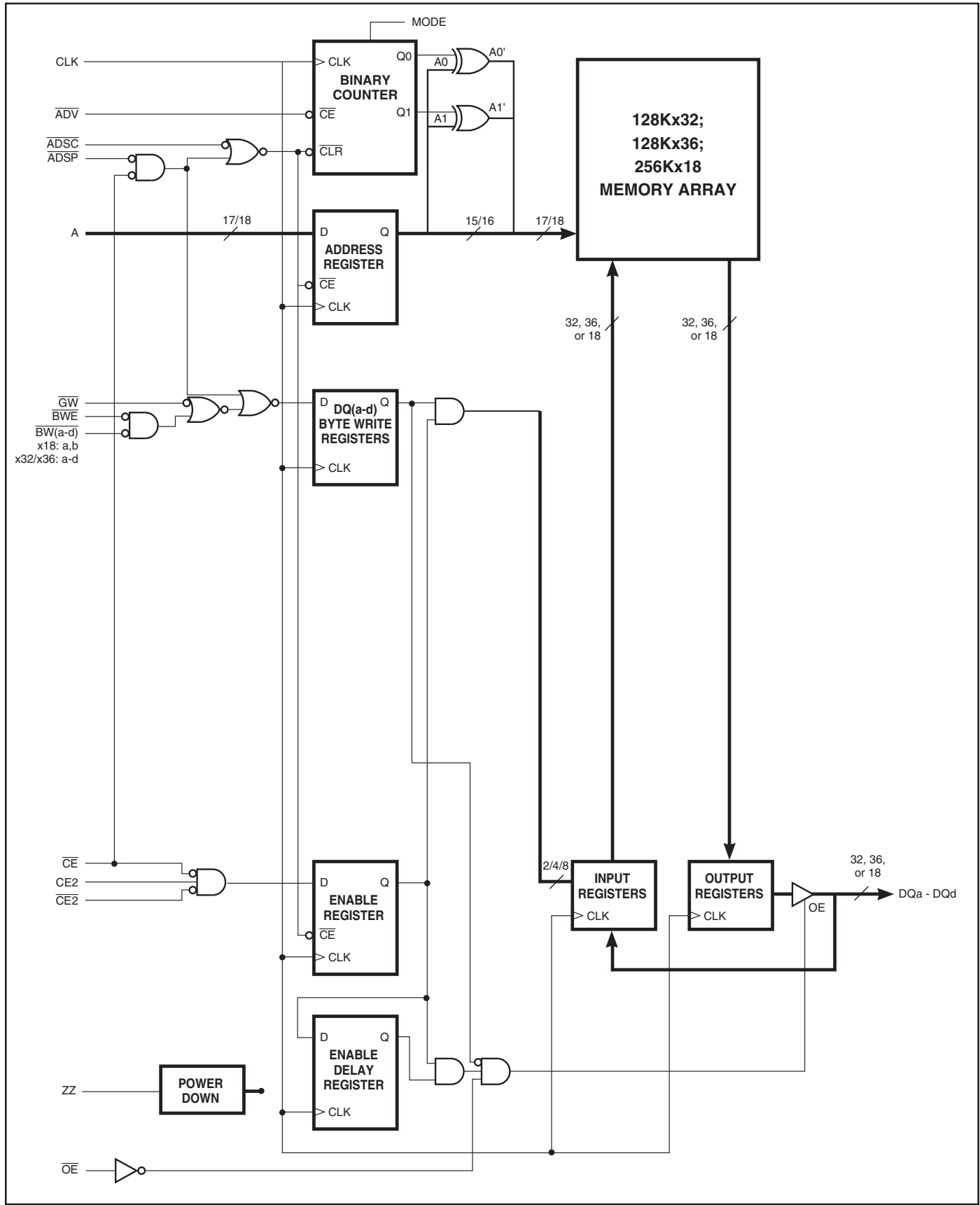

### 165-PIN BGA

165-Ball, 13x15 mm BGA  
1mm Ball Pitch, 11x15 Ball Array

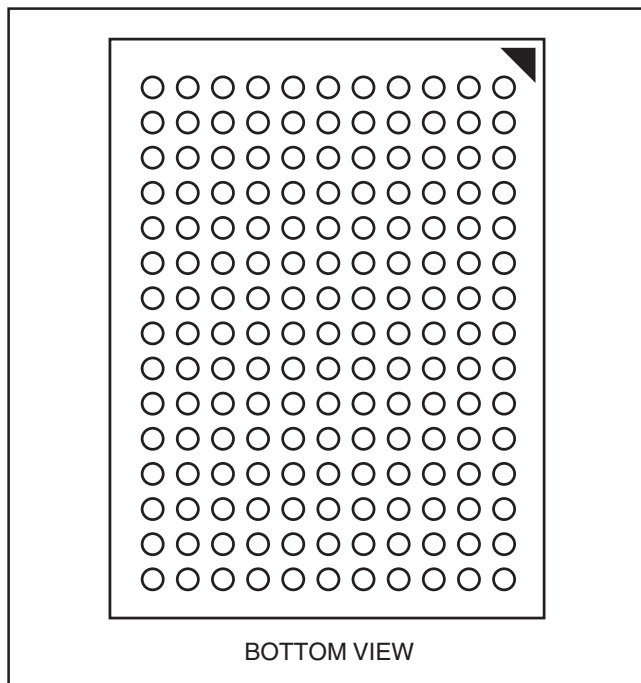

### 119-PIN BGA

119-Ball, 14x22 mm BGA  
1mm Ball Pitch, 7x17 Ball Array

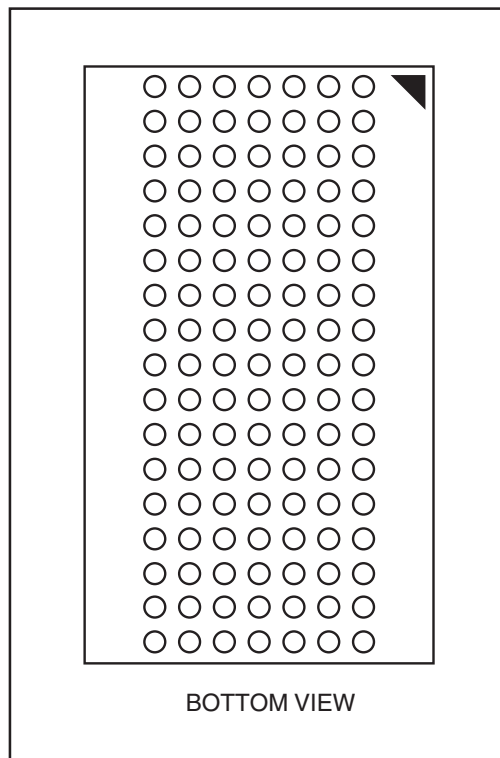

## 119 BGA PACKAGE PIN CONFIGURATION

128K x 36 (TOP VIEW)

	1	2	3	4	5	6	7
<b>A</b>	V <sub>DDQ</sub>	A	A	$\overline{\text{ADSP}}$	A	A	V <sub>DDQ</sub>
<b>B</b>	NC	CE2	A	$\overline{\text{ADSC}}$	A	$\overline{\text{CE2}}$	NC
<b>C</b>	NC	A	A	V <sub>DD</sub>	A	A	NC
<b>D</b>	DQc	DQPc	V <sub>SS</sub>	NC	V <sub>SS</sub>	DQPb	DQb
<b>E</b>	DQc	DQc	V <sub>SS</sub>	$\overline{\text{CE}}$	V <sub>SS</sub>	DQb	DQb
<b>F</b>	V <sub>DDQ</sub>	DQc	V <sub>SS</sub>	$\overline{\text{OE}}$	V <sub>SS</sub>	DQb	V <sub>DDQ</sub>
<b>G</b>	DQc	DQc	$\overline{\text{BWC}}$	$\overline{\text{ADV}}$	$\overline{\text{BWb}}$	DQb	DQb
<b>H</b>	DQc	DQc	V <sub>SS</sub>	$\overline{\text{GW}}$	V <sub>SS</sub>	DQb	DQb
<b>J</b>	V <sub>DDQ</sub>	V <sub>DD</sub>	NC	V <sub>DD</sub>	NC	V <sub>DD</sub>	V <sub>DDQ</sub>
<b>K</b>	DQd	DQd	V <sub>SS</sub>	CLK	V <sub>SS</sub>	DQa	DQa
<b>L</b>	DQd	DQd	$\overline{\text{BWD}}$	NC	$\overline{\text{BWA}}$	DQa	DQa
<b>M</b>	V <sub>DDQ</sub>	DQd	V <sub>SS</sub>	$\overline{\text{BWE}}$	V <sub>SS</sub>	DQa	V <sub>DDQ</sub>
<b>N</b>	DQd	DQd	V <sub>SS</sub>	A <sub>1</sub> *	V <sub>SS</sub>	DQa	DQa
<b>P</b>	DQd	DQPd	V <sub>SS</sub>	A <sub>0</sub> *	V <sub>SS</sub>	DQPd	DQa
<b>R</b>	NC	A	MODE	V <sub>DD</sub>	NC	A	NC
<b>T</b>	NC	NC	A	A	A	NC	ZZ
<b>U</b>	V <sub>DDQ</sub>	NC	NC	NC	NC	NC	V <sub>DDQ</sub>

**Note:** \* A<sub>0</sub> and A<sub>1</sub> are the two least significant bits (LSB) of the address field and set the internal burst counter if burst is desired.

## PIN DESCRIPTIONS

Symbol	Pin Name
A	Address Inputs
A0, A1	Synchronous Burst Address Inputs
$\overline{\text{ADV}}$	Synchronous Burst Address Advance
$\overline{\text{ADSP}}$	Address Status Processor
$\overline{\text{ADSC}}$	Address Status Controller
$\overline{\text{GW}}$	Global Write Enable
CLK	Synchronous Clock
$\overline{\text{CE}}$ , CE2, $\overline{\text{CE2}}$	Synchronous Chip Select
$\overline{\text{BW}}_x$ (x=a-d)	Synchronous Byte Write Controls
$\overline{\text{BWE}}$	Byte Write Enable

Symbol	Pin Name
$\overline{\text{OE}}$	Output Enable
ZZ	Power Sleep Mode
MODE	Burst Sequence Selection
NC	No Connect
DQa-DQd	Data Inputs/Outputs
DQPd-Pd	Output Power Supply
V <sub>DD</sub>	Power Supply
V <sub>DDQ</sub>	Output Power Supply
V <sub>SS</sub>	Ground

## 119 BGA PACKAGE PIN CONFIGURATION

256Kx18 (TOP VIEW)

	1	2	3	4	5	6	7
<b>A</b>	V <sub>DDQ</sub>	A	A	$\overline{\text{ADSP}}$	A	A	V <sub>DDQ</sub>
<b>B</b>	NC	CE2	A	$\overline{\text{ADSC}}$	A	$\overline{\text{CE2}}$	NC
<b>C</b>	NC	A	A	V <sub>DD</sub>	A	A	NC
<b>D</b>	DQ <sub>b</sub>	NC	V <sub>SS</sub>	NC	V <sub>SS</sub>	DQP <sub>a</sub>	NC
<b>E</b>	NC	DQ <sub>b</sub>	V <sub>SS</sub>	$\overline{\text{CE}}$	V <sub>SS</sub>	NC	DQ <sub>a</sub>
<b>F</b>	V <sub>DDQ</sub>	NC	V <sub>SS</sub>	$\overline{\text{OE}}$	V <sub>SS</sub>	DQ <sub>a</sub>	V <sub>DDQ</sub>
<b>G</b>	NC	DQ <sub>b</sub>	$\overline{\text{Bwb}}$	$\overline{\text{ADV}}$	V <sub>SS</sub>	NC	DQ <sub>a</sub>
<b>H</b>	DQ <sub>b</sub>	NC	V <sub>SS</sub>	$\overline{\text{GW}}$	V <sub>SS</sub>	DQ <sub>a</sub>	NC
<b>J</b>	V <sub>DDQ</sub>	V <sub>DD</sub>	NC	V <sub>DD</sub>	NC	V <sub>DD</sub>	V <sub>DDQ</sub>
<b>K</b>	NC	DQ <sub>b</sub>	V <sub>SS</sub>	CLK	V <sub>SS</sub>	NC	DQ <sub>a</sub>
<b>L</b>	DQ <sub>b</sub>	NC	V <sub>SS</sub>	NC	$\overline{\text{Bwa}}$	DQ <sub>a</sub>	NC
<b>M</b>	V <sub>DDQ</sub>	DQ <sub>b</sub>	V <sub>SS</sub>	$\overline{\text{BWE}}$	V <sub>SS</sub>	NC	V <sub>DDQ</sub>
<b>N</b>	DQ <sub>b</sub>	NC	V <sub>SS</sub>	A <sub>1</sub> *	V <sub>SS</sub>	DQ <sub>a</sub>	NC
<b>P</b>	NC	DQP <sub>b</sub>	V <sub>SS</sub>	A <sub>0</sub> *	V <sub>SS</sub>	NC	DQ <sub>a</sub>
<b>R</b>	NC	A	MODE	V <sub>DD</sub>	NC	A	NC
<b>T</b>	NC	A	A	NC	A	A	ZZ
<b>U</b>	V <sub>DDQ</sub>	NC	NC	NC	NC	NC	V <sub>DDQ</sub>

Note: \* A<sub>0</sub> and A<sub>1</sub> are the two least significant bits (LSB) of the address field and set the internal burst counter if burst is desired.

## PIN DESCRIPTIONS

Symbol	Pin Name
A	Address Inputs
A0, A1	Synchronous Burst Address Inputs
$\overline{\text{ADV}}$	Synchronous Burst Address Advance
$\overline{\text{ADSP}}$	Address Status Processor
$\overline{\text{ADSC}}$	Address Status Controller
$\overline{\text{GW}}$	Global Write Enable
CLK	Synchronous Clock
$\overline{\text{CE}}$ , CE2, $\overline{\text{CE2}}$	Synchronous Chip Select
$\overline{\text{BW}}_x$ (x=a,b)	Synchronous Byte Write Controls
$\overline{\text{BWE}}$	Byte Write Enable

Symbol	Pin Name
$\overline{\text{OE}}$	Output Enable
ZZ	Power Sleep Mode
MODE	Burst Sequence Selection
NC	No Connect
DQ <sub>a</sub> -DQ <sub>b</sub>	Data Inputs/Outputs
DQP <sub>a</sub> -P <sub>b</sub>	Output Power Supply
V <sub>DD</sub>	Power Supply
V <sub>DDQ</sub>	Output Power Supply
V <sub>SS</sub>	Ground



## 165 PBGA PACKAGE PIN CONFIGURATION

128K x 36 (TOP VIEW)

	1	2	3	4	5	6	7	8	9	10	11
<b>A</b>	NC	A	$\overline{CE}$	$\overline{BWc}$	$\overline{BWb}$	$\overline{CE2}$	$\overline{BWE}$	$\overline{ADSC}$	$\overline{ADV}$	A	NC
<b>B</b>	NC	A	CE2	$\overline{BWd}$	$\overline{BWa}$	CLK	$\overline{GW}$	$\overline{OE}$	$\overline{ADSP}$	A	NC
<b>C</b>	DQPc	NC	VDDQ	Vss	Vss	Vss	Vss	Vss	VDDQ	NC	DQPb
<b>D</b>	DQc	DQc	VDDQ	VDD	Vss	Vss	Vss	VDD	VDDQ	DQb	DQb
<b>E</b>	DQc	DQc	VDDQ	VDD	Vss	Vss	Vss	VDD	VDDQ	DQb	DQb
<b>F</b>	DQc	DQc	VDDQ	VDD	Vss	Vss	Vss	VDD	VDDQ	DQb	DQb
<b>G</b>	DQc	DQc	VDDQ	VDD	Vss	Vss	Vss	VDD	VDDQ	DQb	DQb
<b>H</b>	NC	NC	NC	VDD	Vss	Vss	Vss	VDD	NC	NC	ZZ
<b>J</b>	DQd	DQd	VDDQ	VDD	Vss	Vss	Vss	VDD	VDDQ	DQa	DQa
<b>K</b>	DQd	DQd	VDDQ	VDD	Vss	Vss	Vss	VDD	VDDQ	DQa	DQa
<b>L</b>	DQd	DQd	VDDQ	VDD	Vss	Vss	Vss	VDD	VDDQ	DQa	DQa
<b>M</b>	DQd	DQd	VDDQ	VDD	Vss	Vss	Vss	VDD	VDDQ	DQa	DQa
<b>N</b>	DQPd	NC	VDDQ	Vss	NC	NC	NC	Vss	VDDQ	NC	DQPd
<b>P</b>	NC	NC	A	A	NC	A1*	NC	A	A	A	NC
<b>R</b>	MODE	NC	A	A	NC	A0*	NC	A	A	A	A

**Note:** \* A0 and A1 are the two least significant bits (LSB) of the address field and set the internal burst counter if burst is desired.

## PIN DESCRIPTIONS

Symbol	Pin Name
A	Address Inputs
A0, A1	Synchronous Burst Address Inputs
$\overline{ADV}$	Synchronous Burst Address Advance
$\overline{ADSP}$	Address Status Processor
$\overline{ADSC}$	Address Status Controller
$\overline{GW}$	Global Write Enable
CLK	Synchronous Clock
$\overline{CE}$ , $\overline{CE2}$ , CE2	Synchronous Chip Select
$\overline{BWx}$ (x=a,b,c,d)	Synchronous Byte Write Controls

Symbol	Pin Name
$\overline{BWE}$	Byte Write Enable
$\overline{OE}$	Output Enable
ZZ	Power Sleep Mode
MODE	Burst Sequence Selection
NC	No Connect
DQx	Data Inputs/Outputs
DQPx	Data Inputs/Outputs
VDD	3.3V/2.5V Power Supply
VDDQ	Isolated Output Power Supply 3.3V/2.5V
Vss	Ground

## 165 PBGA PACKAGE PIN CONFIGURATION

256K x 18 (TOP VIEW)

	1	2	3	4	5	6	7	8	9	10	11
<b>A</b>	NC	A	$\overline{CE}$	$\overline{BWb}$	NC	$\overline{CE2}$	$\overline{BWE}$	$\overline{ADSC}$	$\overline{ADV}$	A	A
<b>B</b>	NC	A	CE2	NC	$\overline{BWa}$	CLK	$\overline{GW}$	$\overline{OE}$	$\overline{ADSP}$	A	NC
<b>C</b>	NC	NC	VDDQ	VSS	VSS	VSS	VSS	VSS	VDDQ	NC	DQP <sub>a</sub>
<b>D</b>	NC	DQ <sub>b</sub>	VDDQ	VDD	VSS	VSS	VSS	VDD	VDDQ	NC	DQ <sub>a</sub>
<b>E</b>	NC	DQ <sub>b</sub>	VDDQ	VDD	VSS	VSS	VSS	VDD	VDDQ	NC	DQ <sub>a</sub>
<b>F</b>	NC	DQ <sub>b</sub>	VDDQ	VDD	VSS	VSS	VSS	VDD	VDDQ	NC	DQ <sub>a</sub>
<b>G</b>	NC	DQ <sub>b</sub>	VDDQ	VDD	VSS	VSS	VSS	VDD	VDDQ	NC	DQ <sub>a</sub>
<b>H</b>	NC	NC	NC	VDD	VSS	VSS	VSS	VDD	NC	NC	ZZ
<b>J</b>	DQ <sub>b</sub>	NC	VDDQ	VDD	VSS	VSS	VSS	VDD	VDDQ	DQ <sub>a</sub>	NC
<b>K</b>	DQ <sub>b</sub>	NC	VDDQ	VDD	VSS	VSS	VSS	VDD	VDDQ	DQ <sub>a</sub>	NC
<b>L</b>	DQ <sub>b</sub>	NC	VDDQ	VDD	VSS	VSS	VSS	VDD	VDDQ	DQ <sub>a</sub>	NC
<b>M</b>	DQ <sub>b</sub>	NC	VDDQ	VDD	VSS	VSS	VSS	VDD	VDDQ	DQ <sub>a</sub>	NC
<b>N</b>	DQP <sub>b</sub>	NC	VDDQ	VSS	NC	NC	NC	VSS	VDDQ	NC	NC
<b>P</b>	NC	NC	A	A	NC	A1*	NC	A	A	A	NC
<b>R</b>	MODE	NC	A	A	NC	A0*	NC	A	A	A	A

**Note:** \* A<sub>0</sub> and A<sub>1</sub> are the two least significant bits (LSB) of the address field and set the internal burst counter if burst is desired.

## PIN DESCRIPTIONS

Symbol	Pin Name
A	Address Inputs
A0, A1	Synchronous Burst Address Inputs
$\overline{ADV}$	Synchronous Burst Address Advance
$\overline{ADSP}$	Address Status Processor
$\overline{ADSC}$	Address Status Controller
$\overline{GW}$	Global Write Enable
CLK	Synchronous Clock
$\overline{CE}$ , $\overline{CE2}$ , CE2	Synchronous Chip Select
$\overline{BWx}$ (x=a,b)	Synchronous Byte Write Controls

Symbol	Pin Name
$\overline{BWE}$	Byte Write Enable
$\overline{OE}$	Output Enable
ZZ	Power Sleep Mode
MODE	Burst Sequence Selection
NC	No Connect
DQ <sub>x</sub>	Data Inputs/Outputs
DQP <sub>x</sub>	Data Inputs/Outputs
VDD	3.3V/2.5V Power Supply
VDDQ	Isolated Output Power Supply 3.3V/2.5V
VSS	Ground

## PIN CONFIGURATION

100-PIN TQFP (128K X 36)

100-PIN TQFP (128K X 32)

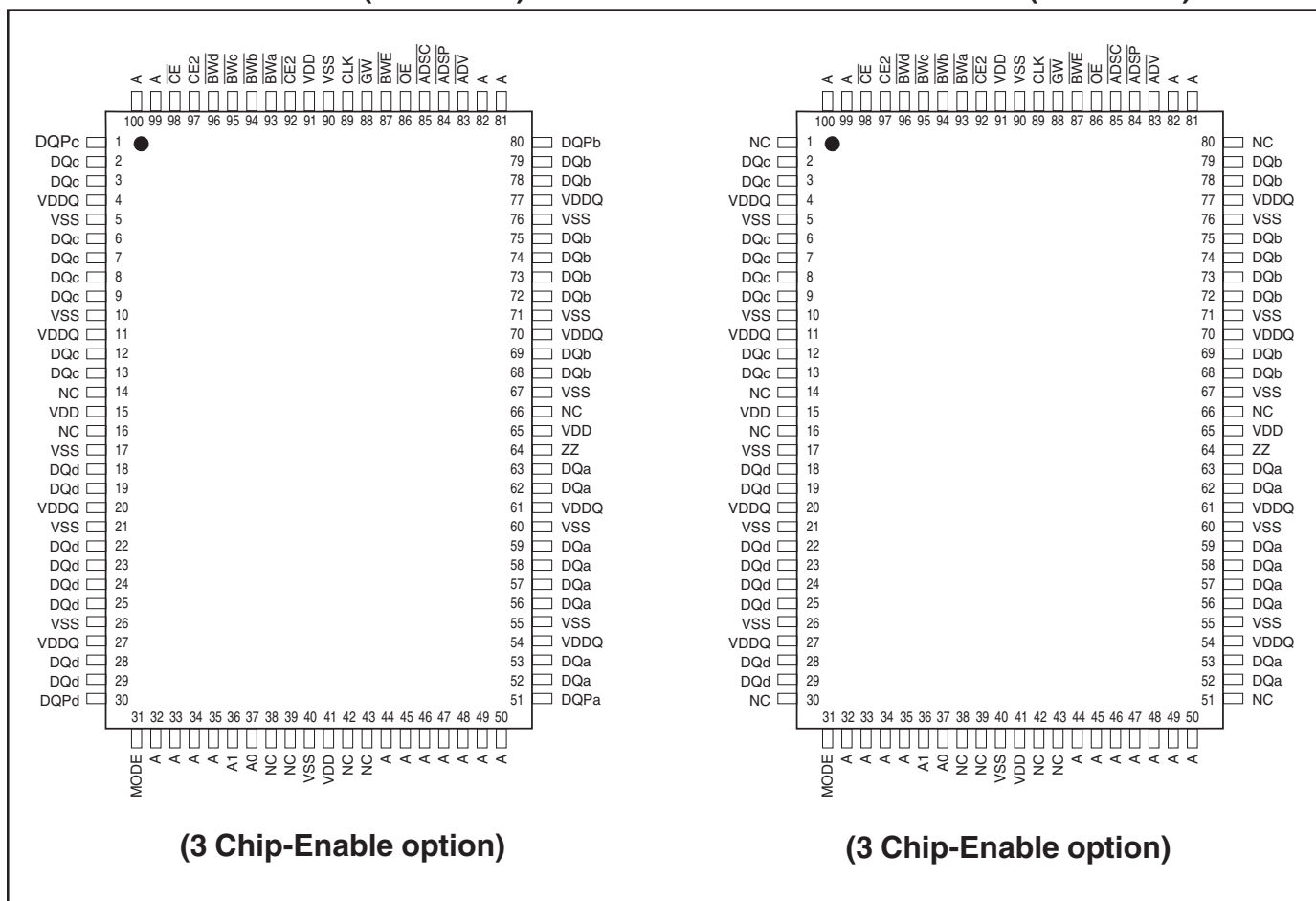

## PIN DESCRIPTIONS

A0, A1	Synchronous Address Inputs. These pins must tied to the two LSBs of the address bus.
A	Synchronous Address Inputs
$\overline{\text{ADSC}}$	Synchronous Controller Address Status
$\overline{\text{ADSP}}$	Synchronous Processor Address Status
$\overline{\text{ADV}}$	Synchronous Burst Address Advance
$\overline{\text{BWA}}\text{-}\overline{\text{BWD}}$	Synchronous Byte Write Enable
$\overline{\text{BWE}}$	Synchronous Byte Write Enable
$\overline{\text{CE}}$ , $\overline{\text{CE2}}$ , CE2	Synchronous Chip Enable
CLK	Synchronous Clock

DQa-DQd	Synchronous Data Input/Output
DQPa-DQPd	Parity Data Input/Output
$\overline{\text{GW}}$	Synchronous Global Write Enable
MODE	Burst Sequence Mode Selection
$\overline{\text{OE}}$	Output Enable
VDD	3.3V/2.5V Power Supply
VDDQ	Isolated Output Buffer Supply: 3.3V/2.5V
VSS	Ground
ZZ	Snooze Enable







**TRUTH TABLE<sup>(1-8)</sup>**

OPERATION	ADDRESS	$\overline{CE}$	$\overline{CE2}$	CE2	ZZ	$\overline{ADSP}$	$\overline{ADSC}$	$\overline{ADV}$	WRITE	$\overline{OE}$	CLK	DQ
Deselect Cycle, Power-Down	None	H	X	X	L	X	L	X	X	X	L-H	High-Z
Deselect Cycle, Power-Down	None	L	X	L	L	L	X	X	X	X	L-H	High-Z
Deselect Cycle, Power-Down	None	L	H	X	L	L	X	X	X	X	L-H	High-Z
Deselect Cycle, Power-Down	None	L	X	L	L	H	L	X	X	X	L-H	High-Z
Deselect Cycle, Power-Down	None	L	H	X	L	H	L	X	X	X	L-H	High-Z
Snooze Mode, Power-Down	None	X	X	X	H	X	X	X	X	X	X	High-Z
Read Cycle, Begin Burst	External	L	L	H	L	L	X	X	X	L	L-H	Q
Read Cycle, Begin Burst	External	L	L	H	L	L	X	X	X	H	L-H	High-Z
Write Cycle, Begin Burst	External	L	L	H	L	H	L	X	L	X	L-H	D
Read Cycle, Begin Burst	External	L	L	H	L	H	L	X	H	L	L-H	Q
Read Cycle, Begin Burst	External	L	L	H	L	H	L	X	H	H	L-H	High-Z
Read Cycle, Continue Burst	Next	X	X	X	L	H	H	L	H	L	L-H	Q
Read Cycle, Continue Burst	Next	X	X	X	L	H	H	L	H	H	L-H	High-Z
Read Cycle, Continue Burst	Next	H	X	X	L	X	H	L	H	L	L-H	Q
Read Cycle, Continue Burst	Next	H	X	X	L	X	H	L	H	H	L-H	High-Z
Write Cycle, Continue Burst	Next	X	X	X	L	H	H	L	L	X	L-H	D
Write Cycle, Continue Burst	Next	H	X	X	L	X	H	L	L	X	L-H	D
Read Cycle, Suspend Burst	Current	X	X	X	L	H	H	H	H	L	L-H	Q
Read Cycle, Suspend Burst	Current	X	X	X	L	H	H	H	H	H	L-H	High-Z
Read Cycle, Suspend Burst	Current	H	X	X	L	X	H	H	H	L	L-H	Q
Read Cycle, Suspend Burst	Current	H	X	X	L	X	H	H	H	H	L-H	High-Z
Write Cycle, Suspend Burst	Current	X	X	X	L	H	H	H	L	X	L-H	D
Write Cycle, Suspend Burst	Current	H	X	X	L	X	H	H	L	X	L-H	D

**NOTE:**

1. X means "Don't Care." H means logic HIGH. L means logic LOW.
2. For **WRITE**, L means one or more byte write enable signals ( $\overline{BWA-d}$ ) and  $\overline{BWE}$  are LOW or  $\overline{GW}$  is LOW. **WRITE** = H for all  $\overline{BWx}$ ,  $\overline{BWE}$ ,  $\overline{GW}$  HIGH.
3.  $\overline{BWA}$  enables WRITES to DQa's and DQP<sub>a</sub>.  $\overline{BWb}$  enables WRITES to DQb's and DQP<sub>b</sub>.  $\overline{BWC}$  enables WRITES to DQc's and DQP<sub>c</sub>.  $\overline{BWD}$  enables WRITES to DQd's and DQP<sub>d</sub>. DQP<sub>a</sub> and DQP<sub>b</sub> are available on the x18 version. DQP<sub>a</sub>-DQP<sub>d</sub> are available on the x36 version.
4. All inputs except  $\overline{OE}$  and ZZ must meet setup and hold times around the rising edge (LOW to HIGH) of CLK.
5. Wait states are inserted by suspending burst.
6. For a WRITE operation following a READ operation,  $\overline{OE}$  must be HIGH before the input data setup time and held HIGH during the input data hold time.
7. This device contains circuitry that will ensure the outputs will be in High-Z during power-up.
8.  $\overline{ADSP}$  LOW always initiates an internal READ at the L-H edge of CLK. A WRITE is performed by setting one or more byte write enable signals and  $\overline{BWE}$  LOW or  $\overline{GW}$  LOW for the subsequent L-H edge of CLK. See WRITE timing diagram for clarification.

**PARTIAL TRUTH TABLE**

Function	$\overline{GW}$	$\overline{BWE}$	$\overline{BWA}$	$\overline{BWb}$	$\overline{BWC}$	$\overline{BWD}$
Read	H	H	X	X	X	X
Read	H	L	H	H	H	H
Write Byte 1	H	L	L	H	H	H
Write All Bytes	H	L	L	L	L	L
Write All Bytes	L	X	X	X	X	X

**INTERLEAVED BURST ADDRESS TABLE (MODE = V<sub>DD</sub> or No Connect)**

External Address A1 A0	1st Burst Address A1 A0	2nd Burst Address A1 A0	3rd Burst Address A1 A0
00	01	10	11
01	00	11	10
10	11	00	01
11	10	01	00

**LINEAR BURST ADDRESS TABLE (MODE = V<sub>SS</sub>)**

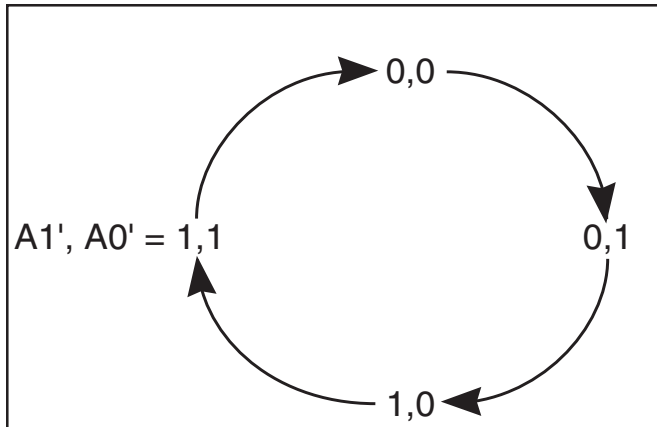

**ABSOLUTE MAXIMUM RATINGS<sup>(1)</sup>**

Symbol	Parameter	Value	Unit
T <sub>STG</sub>	Storage Temperature	-55 to +150	°C
P <sub>D</sub>	Power Dissipation	1.6	W
I <sub>OUT</sub>	Output Current (per I/O)	100	mA
V <sub>IN</sub> , V <sub>OUT</sub>	Voltage Relative to V <sub>SS</sub> for I/O Pins	-0.5 to V <sub>DDQ</sub> + 0.5	V
V <sub>IN</sub>	Voltage Relative to V <sub>SS</sub> for for Address and Control Inputs	-0.5 to V <sub>DD</sub> + 0.5	V
V <sub>DD</sub>	Voltage on V <sub>DD</sub> Supply Relative to V <sub>SS</sub>	-0.5 to 4.6	V

**Notes:**

1. Stress greater than those listed under ABSOLUTE MAXIMUM RATINGS may cause permanent damage to the device. This is a stress rating only and functional operation of the device at these or any other conditions above those indicated in the operational sections of this specification is not implied. Exposure to absolute maximum rating conditions for extended periods may affect reliability.
2. This device contains circuitry to protect the inputs against damage due to high static voltages or electric fields; however, precautions may be taken to avoid application of any voltage higher than maximum rated voltages to this high-impedance circuit.
3. This device contains circuitry that will ensure the output devices are in High-Z at power up.

### OPERATING RANGE (IS61/64LPSXXXXX)

Range	Ambient Temperature	V <sub>DD</sub>	V <sub>DDQ</sub>
Commercial	0°C to +70°C	3.3V ± 5%	3.3V / 2.5V ± 5%
Industrial	-40°C to +85°C	3.3V ± 5%	3.3V / 2.5V ± 5%
Automotive	-40°C to +125°C	3.3V ± 5%	3.3V / 2.5V ± 5%

### OPERATING RANGE (IS61/64VPSXXXXX)

Range	Ambient Temperature	V <sub>DD</sub>	V <sub>DDQ</sub>
Commercial	0°C to +70°C	2.5V ± 5%	2.5V ± 5%
Industrial	-40°C to +85°C	2.5V ± 5%	2.5V ± 5%
Automotive	-40°C to +125°C	2.5V ± 5%	2.5V ± 5%

### DC ELECTRICAL CHARACTERISTICS (Over Operating Range)

Symbol	Parameter	Test Conditions	3.3V		2.5V		Unit
			Min.	Max.	Min.	Max.	
V <sub>OH</sub>	Output HIGH Voltage	I <sub>OH</sub> = -4.0 mA (3.3V) I <sub>OH</sub> = -1.0 mA (2.5V)	2.4	—	2.0	—	V
V <sub>OL</sub>	Output LOW Voltage	I <sub>OL</sub> = 8.0 mA (3.3V) I <sub>OL</sub> = 1.0 mA (2.5V)	—	0.4	—	0.4	V
V <sub>IH</sub>	Input HIGH Voltage		2.0	V <sub>DD</sub> + 0.3	1.7	V <sub>DD</sub> + 0.3	V
V <sub>IL</sub>	Input LOW Voltage		-0.3	0.8	-0.3	0.7	V
I <sub>LI</sub>	Input Leakage Current	V <sub>SS</sub> ≤ V <sub>IN</sub> ≤ V <sub>DD</sub> <sup>(1)</sup>	-5	5	-5	5	μA
I <sub>LO</sub>	Output Leakage Current	V <sub>SS</sub> ≤ V <sub>OUT</sub> ≤ V <sub>DDQ</sub> , $\overline{OE} = V_{IH}$	-5	5	-5	5	μA

**POWER SUPPLY CHARACTERISTICS<sup>(1)</sup>** (Over Operating Range)

Symbol	Parameter	Test Conditions	Temp. range	-250 MAX		-200 MAX		Unit
				x18	x32/x36	x18	x32/x36	
I <sub>CC</sub>	AC Operating Supply Current	Device Selected, $\overline{OE} = V_{IH}$ , $ZZ \leq V_{IL}$ , All Inputs $\leq 0.2V$ or $\geq V_{DD} - 0.2V$ , Cycle Time $\geq t_{kc}$ min.	Com.	225	225	200	200	mA
			Ind.	250	250	210	210	
			Auto.	275	275	225	225	
I <sub>SB</sub>	Standby Current TTL Input	Device Deselected, $V_{DD} = \text{Max.}$ , All Inputs $\leq V_{IL}$ or $\geq V_{IH}$ , $ZZ \leq V_{IL}$ , $f = \text{Max.}$	Com.	90	90	90	90	mA
			Ind.	100	100	100	100	
			Auto.	120	120	120	120	
I <sub>SBI</sub>	Standby Current CMOS Input	Device Deselected, $V_{DD} = \text{Max.}$ , $V_{IN} \leq V_{SS} + 0.2V$ or $\geq V_{DD} - 0.2V$ $f = 0$	Com.	70	70	70	70	mA
			Ind.	75	75	75	75	
			Auto.	90	90	90	90	
			typ. <sup>(2)</sup>	40		40		

**Note:**

1. MODE pin has an internal pullup and should be tied to  $V_{DD}$  or  $V_{SS}$ . It exhibits  $\pm 100\mu A$  maximum leakage current when tied to  $\leq V_{SS} + 0.2V$  or  $\geq V_{DD} - 0.2V$ .
2. Typical values are measured at  $V_{DD} = 3.3V$ ,  $T_A = 25^\circ C$  and not 100% tested.

## CAPACITANCE<sup>(1,2)</sup>

Symbol	Parameter	Conditions	Max.	Unit
C <sub>IN</sub>	Input Capacitance	V <sub>IN</sub> = 0V	6	pF
C <sub>OUT</sub>	Input/Output Capacitance	V <sub>OUT</sub> = 0V	8	pF

### Notes:

1. Tested initially and after any design or process changes that may affect these parameters.
2. Test conditions: T<sub>A</sub> = 25°C, f = 1 MHz, V<sub>DD</sub> = 3.3V.

## 3.3V I/O AC TEST CONDITIONS

Parameter	Unit
Input Pulse Level	0V to 3.0V
Input Rise and Fall Times	1.5 ns
Input and Output Timing and Reference Level	1.5V
Output Load	See Figures 1 and 2

## AC TEST LOADS

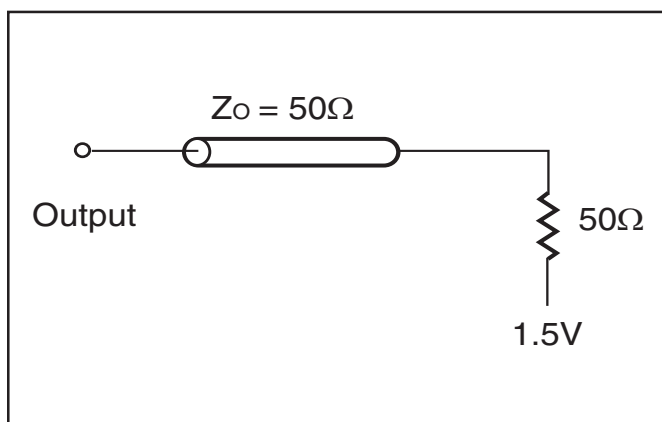

Figure 1



Figure 2

## 2.5V I/O AC TEST CONDITIONS

Parameter	Unit
Input Pulse Level	0V to 2.5V
Input Rise and Fall Times	1.5 ns
Input and Output Timing and Reference Level	1.25V
Output Load	See Figures 3 and 4

## 2.5 I/O OUTPUT LOAD EQUIVALENT



Figure 3



Figure 4

**READ/WRITE CYCLE SWITCHING CHARACTERISTICS** (Over Operating Range)

Symbol	Parameter	-250		-200		Unit
		Min.	Max.	Min.	Max.	
f <sub>MAX</sub>	Clock Frequency	—	250	—	200	MHz
t <sub>KC</sub>	Cycle Time	4.0	—	5	—	ns
t <sub>KH</sub>	Clock High Time	1.7	—	2	—	ns
t <sub>KL</sub>	Clock Low Time	1.7	—	2	—	ns
t <sub>KQ</sub>	Clock Access Time	—	2.6	—	3.1	ns
t <sub>KQX</sub> <sup>(2)</sup>	Clock High to Output Invalid	0.8	—	1.5	—	ns
t <sub>KQLZ</sub> <sup>(2,3)</sup>	Clock High to Output Low-Z	0.8	—	1	—	ns
t <sub>KQHZ</sub> <sup>(2,3)</sup>	Clock High to Output High-Z	—	2.6	—	3.0	ns
t <sub>OEQ</sub>	Output Enable to Output Valid	—	2.8	—	3.1	ns
t <sub>OEQX</sub> <sup>(2)</sup>	Output Disable to Output Invalid	0	—	0	—	ns
t <sub>OELZ</sub> <sup>(2,3)</sup>	Output Enable to Output Low-Z	0	—	0	—	ns
t <sub>OEHZ</sub> <sup>(2,3)</sup>	Output Disable to Output High-Z	—	2.6	—	3.0	ns
t <sub>AS</sub>	Address Setup Time	1.2	—	1.4	—	ns
t <sub>SS</sub>	Address Status Setup Time	1.2	—	1.4	—	ns
t <sub>WS</sub>	Read/Write Setup Time	1.2	—	1.4	—	ns
t <sub>CES</sub>	Chip Enable Setup Time	1.2	—	1.4	—	ns
t <sub>AVS</sub>	Address Advance Setup Time	1.2	—	1.4	—	ns
t <sub>DS</sub>	Data Setup Time	1.2	—	1.4	—	ns
t <sub>AH</sub>	Address Hold Time	0.3	—	0.4	—	ns
t <sub>SH</sub>	Address Status Hold Time	0.3	—	0.4	—	ns
t <sub>WH</sub>	Write Hold Time	0.3	—	0.4	—	ns
t <sub>CEH</sub>	Chip Enable Hold Time	0.3	—	0.4	—	ns
t <sub>AVH</sub>	Address Advance Hold Time	0.3	—	0.4	—	ns
t <sub>DH</sub>	Data Hold Time	0.3	—	0.4	—	ns

**Note:**

1. Configuration signal MODE is static and must not change during normal operation.
2. Guaranteed but not 100% tested. This parameter is periodically sampled.
3. Tested with load in Figure 2.



### READ/WRITE CYCLE TIMING



## WRITE CYCLE TIMING



## SNOOZE MODE ELECTRICAL CHARACTERISTICS

Symbol	Parameter	Conditions	Min.	Max.	Unit
$I_{SB2}$	Current during SNOOZE MODE	$ZZ \geq V_{ih}$	—	60	mA
$t_{PDS}$	ZZ active to input ignored		2	—	cycle
$t_{PUS}$	ZZ inactive to input sampled		2	—	cycle
$t_{ZZI}$	ZZ active to SNOOZE current		—	2	cycle
$t_{RZZI}$	ZZ inactive to exit SNOOZE current		0	—	ns

## SNOOZE MODE TIMING





**ORDERING INFORMATION (3.3V core/2.5V-3.3V I/O)**

**Commercial Range: 0°C to +70°C**

Configuration	Frequency	Order Part Number	Package
<b>128Kx32</b>			
	250	IS61LPS12832A-250TQ	100 TQFP
		IS61LPS12832A-250B2	119 PBGA
		IS61LPS12832A-250B3	165 PBGA
	200	IS61LPS12832A-200TQ	100 TQFP
		IS61LPS12832A-200B2	119 PBGA
		IS61LPS12832A-200B3	165 PBGA
<b>128Kx36</b>			
	250	IS61LPS12836A-250TQ	100 TQFP
		IS61LPS12836A-250TQL	100 TQFP, Lead-free
		IS61LPS12836A-250B2	119 PBGA
		IS61LPS12836A-250B3	165 PBGA
	200	IS61LPS12836A-200TQ	100 TQFP
		IS61LPS12836A-200B2	119 PBGA
		IS61LPS12836A-200B3	165 PBGA
<b>256Kx18</b>			
	250	IS61LPS25618A-250TQ	100 TQFP
		IS61LPS25618A-250B2	119 PBGA
		IS61LPS25618A-250B3	165 PBGA
	200	IS61LPS25618A-200TQ	100 TQFP
		IS61LPS25618A-200B2	119 PBGA
		IS61LPS25618A-200B3	165 PBGA

**ORDERING INFORMATION (3.3V core/2.5V-3.3V I/O)**

**Industrial Range: -40°C to +85°C**

Configuration	Frequency	Order Part Number	Package
<b>128Kx32</b>			
	250	IS61LPS12832A-250TQI	100 TQFP
		IS61LPS12832A-250B2I	119 PBGA
		IS61LPS12832A-250B3I	165 PBGA
	200	IS61LPS12832A-200TQI	100 TQFP
		IS61LPS12832A-200TQLI	100 TQFP, Lead-free
		IS61LPS12832A-200B2I	119 PBGA
		IS61LPS12832A-200B3I	165 PBGA
<b>128Kx36</b>			
	250	IS61LPS12836A-250TQI	100 TQFP
		IS61LPS12836A-250B2I	119 PBGA
		IS61LPS12836A-250B3I	165 PBGA
	200	IS61LPS12836A-200TQI	100 TQFP
		IS61LPS12836A-200TQLI	100 TQFP, Lead-free
		IS61LPS12836A-200B2I	119 PBGA
		IS61LPS12836A-200B2LI	119 PBGA, Lead-free
		IS61LPS12836A-200B3I	165 PBGA
<b>256Kx18</b>			
	250	IS61LPS25618A-250TQI	100 TQFP
		IS61LPS25618A-250B2I	119 PBGA
		IS61LPS25618A-250B3I	165 PBGA
	200	IS61LPS25618A-200TQI	100 TQFP
		IS61LPS25618A-200TQLI	100 TQFP, Lead-free
		IS61LPS25618A-200B2I	119 PBGA
		IS61LPS25618A-200B3I	165 PBGA

**Automotive Range: -40°C to +125°C**

Configuration	Frequency	Order Part Number	Package
<b>128Kx32</b>			
	200	IS64LPS12832A-200TQA3	100 TQFP
		IS64LPS12832A-200TQLA3	100 TQFP, Lead-free
<b>128Kx36</b>			
	200	IS64LPS12836A-200TQA3	100 TQFP
<b>256Kx18</b>			
	200	IS64LPS25618A-200TQA3	100 TQFP
		IS64LPS25618A-200TQLA3	100 TQFP, Lead-free

IS61(64)LPS12832A

IS61(64)LPS12836A IS61(64)VPS12836A

IS61(64)LPS25618A IS61(64)VPS25618A



**ORDERING INFORMATION (2.5V core/2.5V I/O)**

**Commercial Range: 0°C to +70°C**

Configuration	Frequency	Order Part Number	Package
<b>128Kx36</b>			
	250	IS61VPS12836A-250TQ	100 TQFP
		IS61VPS12836A-250B2	119 PBGA
		IS61VPS12836A-250B3	165 PBGA
	200	IS61VPS12836A-200TQ	100 TQFP
		IS61VPS12836A-200B2	119 PBGA
		IS61VPS12836A-200B3	165 PBGA
<b>256Kx18</b>			
	250	IS61VPS25618A-250TQ	100 TQFP
		IS61VPS25618A-250B2	119 PBGA
		IS61VPS25618A-250B3	165 PBGA
	200	IS61VPS25618A-200TQ	100 TQFP
		IS61VPS25618A-200B2	119 PBGA
		IS61VPS25618A-200B3	165 PBGA



**Industrial Range: -40°C to +85°C**

Configuration	Frequency	Order Part Number	Package
<b>128Kx36</b>			
	250	IS61VPS12836A-250TQI	100 TQFP
		IS61VPS12836A-250B2I	119 PBGA
		IS61VPS12836A-250B3I	165 PBGA
	200	IS61VPS12836A-200TQI	100 TQFP
		IS61VPS12836A-200B2I	119 PBGA
		IS61VPS12836A-200B3I	165 PBGA
<b>256Kx18</b>			
	250	IS61VPS25618A-250TQI	100 TQFP
		IS61VPS25618A-250B2I	119 PBGA
		IS61VPS25618A-250B3I	165 PBGA
	200	IS61VPS25618A-200TQI	100 TQFP
		IS61VPS25618A-200B2I	119 PBGA
		IS61VPS25618A-200B3I	165 PBGA

**Automotive Range: -40°C to +125°C**

Configuration	Frequency	Order Part Number	Package
<b>128Kx32</b>			
	200	IS64VPS12832A-200TQA3	100 TQFP
<b>128Kx36</b>			
	200	IS64VPS12836A-200TQA3	100 TQFP
<b>256Kx18</b>			
	200	IS64VPS25618A-200TQA3	100 TQFP



SYMBOL	DIMENSION IN MM		DIMENSION IN INCH	
	MIN.	NOM. MAX.	MIN.	NOM. MAX.
A	1.40	1.60	0.055	0.063
A1	0.05	0.15	0.002	0.006
A2	1.35	1.45	0.053	0.057
b	0.22	0.38	0.009	0.012
D	21.90	22.00	0.862	0.870
D1	19.90	20.00	0.783	0.791
E	15.90	16.00	0.626	0.634
E1	13.90	14.00	0.547	0.555
e	0.65 BSC.		0.026	BSC.
L	0.45	0.60	0.018	0.024
L1	0.25 BSC.		0.010	BSC.
ZD	0.575 REF.		0.023	REF.
ZE	0.825 REF.		0.032	REF.
theta	0	3.5°	0	3.5°
		7°		7°

**NOTE :**  
 1. CONTROLLING DIMENSION : MM  
 2. DIMENSION D1 AND E1 DO NOT INCLUDE MOLD PROTRUSION.  
 3. DIMENSION b DOES NOT INCLUDE DAMBAR PROTRUSION/INTRUSION.

	TITLE	100L 14x20x1.4mm LQFP (Footprint : 2.0 mm) Package Outline	REV.	F	DATE	09/01/2009
---	-------	--	------	---	------	------------

280-600-011 REV. A



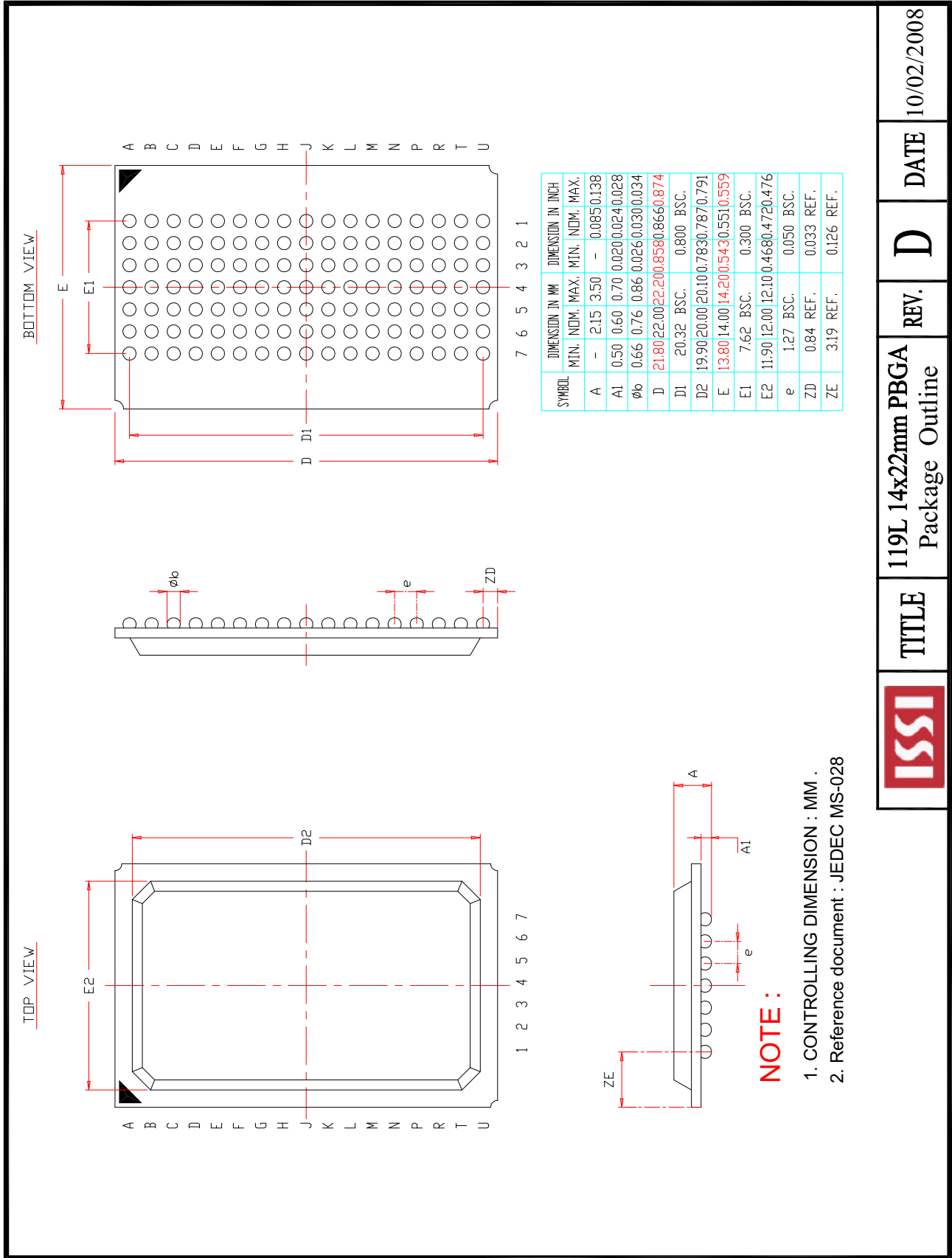

	<b>TITLE</b>	119L 14x22mm PBGA Package Outline	<b>REV.</b>	D	<b>DATE</b>	10/02/2008
--	--------------	--------------------------------------	-------------	---	-------------	------------



SYM.	DIMENSION (mm)			DIMENSION (inch)		
	MIN.	NOM.	MAX.	MIN.	NOM.	MAX.
A	—	—	1.20	—	—	0.047
A1	0.25	0.35	0.40	0.010	0.014	0.016
A2	—	0.79	—	—	0.031	—
b	0.40	0.45	0.50	0.016	0.018	0.020
D	14.90	15.00	15.10	0.587	0.591	0.594
D1	13.90	14.00	14.10	0.547	0.551	0.555
E	12.90	13.00	13.10	0.508	0.512	0.516
E1	9.90	10.00	10.10	0.390	0.394	0.398
E	1.00 BSC			0.039 BSC		

**NOTE :**

1. CONTROLLING DIMENSION : MM .



	TITLE	165L 13x15mm TF-BGA Package Outline	REV.	B	DATE	08/28/2008
--	-------	--	------	---	------	------------



## Стандарт Электрон Связь

Мы молодая и активно развивающаяся компания в области поставок электронных компонентов. Мы поставляем электронные компоненты отечественного и импортного производства напрямую от производителей и с крупнейших складов мира.

Благодаря сотрудничеству с мировыми поставщиками мы осуществляем комплексные и плановые поставки широчайшего спектра электронных компонентов.

Собственная эффективная логистика и склад в обеспечивает надежную поставку продукции в точно указанные сроки по всей России.

Мы осуществляем техническую поддержку нашим клиентам и предпродажную проверку качества продукции. На все поставляемые продукты мы предоставляем гарантию .

Осуществляем поставки продукции под контролем ВП МО РФ на предприятия военно-промышленного комплекса России , а также работаем в рамках 275 ФЗ с открытием отдельных счетов в уполномоченном банке. Система менеджмента качества компании соответствует требованиям ГОСТ ISO 9001.

Минимальные сроки поставки, гибкие цены, неограниченный ассортимент и индивидуальный подход к клиентам являются основой для выстраивания долгосрочного и эффективного сотрудничества с предприятиями радиоэлектронной промышленности, предприятиями ВПК и научно-исследовательскими институтами России.

С нами вы становитесь еще успешнее!

### Наши контакты:

**Телефон:** +7 812 627 14 35

**Электронная почта:** [sales@st-electron.ru](mailto:sales@st-electron.ru)

**Адрес:** 198099, Санкт-Петербург,  
Промышленная ул, дом № 19, литера Н,  
помещение 100-Н Офис 331