

# CGHV40180F

180 W, DC - 1000 MHz, 50 V, GaN HEMT

Cree's CGHV40180F is an unmatched, gallium nitride (GaN) high electron mobility transistor (HEMT). The CGHV40180F, operating from a 50 volt rail, offers a general purpose, broadband solution to a variety of RF and microwave applications. GaN HEMTs offer high efficiency, high gain and wide bandwidth capabilities making the CGHV40180F ideal for linear and compressed amplifier circuits. The transistor is available in a 2-lead flange package.



Package Types: 440223  
PN: CGHV40180F

## Typical Performance Over 800 MHz - 1000 MHz ( $T_c = 25^\circ\text{C}$ ), 50 V

Parameter	800 MHz	850 MHz	900 MHz	950 MHz	1000 MHz	Units
Small Signal Gain	25.6	25.2	24.9	24.4	24.3	dB
Gain @ Pin 34 dBm	20.4	20.8	20.3	20.1	20.1	dB
Output Power @ Pin 34 dBm	275	302	28.9	257	257	W
EFF @ Pin 34 dBm	67	75	73	73	71	%

Note:  
Measured CW in the CGHV40180F-AMP Application circuit.



### FEATURES

- Up to 1000 MHz Operation
- 24 dB Small Signal Gain at 900 MHz
- 20 dB Power Gain at 900 MHz
- 250 W Typical Output Power at 900 MHz
- 75 % Efficiency at  $P_{SAT}$

### APPLICATIONS

- Military Communications
- Public Safety VHF-UHF applications
- Radar
- Medical
- Broadband Amplifiers

Large Signal Models Available for ADS and MWO

## Absolute Maximum Ratings (not simultaneous) at 25°C Case Temperature

Parameter	Symbol	Rating	Units	Conditions
Drain-Source Voltage	$V_{DSS}$	125	Volts	25°C
Gate-to-Source Voltage	$V_{GS}$	-10, +2	Volts	25°C
Storage Temperature	$T_{STG}$	-65, +150	°C	
Operating Junction Temperature <sup>1</sup>	$T_J$	225	°C	
Maximum Forward Gate Current	$I_{GMAX}$	42	mA	25°C
Maximum Drain Current	$I_{DMAX}$	18	A	25°C
Soldering Temperature <sup>2</sup>	$T_S$	245	°C	
Screw Torque	$\tau$	40	in-oz	
CGHV40180F Thermal Resistance, Junction to Case	$R_{JJC}$	0.95	°C/W	$P_{DISS} = 150, 85^\circ\text{C}$
Maximum dissipated power		150	W	$P_{DISS} = 150, 85^\circ\text{C}$
Case Operating Temperature <sup>3</sup>	$T_C$	-40, +150	°C	

Note:

<sup>1</sup> Current limit for long term, reliable operation

<sup>2</sup> Refer to the Application Note on soldering at [www.cree.com/RF/Document-Library](http://www.cree.com/RF/Document-Library)

<sup>3</sup> See also, Power Derating Curve on Page 5.

## Electrical Characteristics

Characteristics	Symbol	Min.	Typ.	Max.	Units	Conditions
<b>DC Characteristics<sup>1</sup> (<math>T_C = 25^\circ\text{C}</math>)</b>						
Gate Threshold Voltage	$V_{GS(th)}$	-3.8	-3.0	-2.3	$V_{DC}$	$V_{DS} = 10\text{ V}, I_D = 20.8\text{ mA}$
Gate Quiescent Voltage	$V_{GS(Q)}$	-	-2.7	-	$V_{DC}$	$V_{DS} = 50\text{ V}, I_D = 1000\text{ mA}$
Saturated Drain Current <sup>2</sup>	$I_{DS}$	31.4	37.6	-	A	$V_{DS} = 6.0\text{ V}, V_{GS} = 2.0\text{ V}$
Drain-Source Breakdown Voltage	$V_{BR}$	150	-	-	$V_{DC}$	$V_{GS} = -8\text{ V}, I_D = 41.8\text{ mA}$
<b>RF Characteristics<sup>2,3</sup> (<math>T_C = 25^\circ\text{C}, F_0 = 900\text{ MHz}</math> unless otherwise noted)</b>						
Small Signal Gain	$G_{SS}$	-	24.9	-	dB	$V_{DD} = 50\text{ V}, I_{DQ} = 1.0\text{ A}, P_{in} = 10\text{ dBm CW}$
Power Gain	$G_P$	-	20.3	-	dB	$V_{DD} = 50\text{ V}, I_{DQ} = 1.0\text{ A}, P_{in} = 34\text{ dBm CW}$
Power Output at Saturation	$P_{OUT}$	-	54.3	-	dBm	$V_{DD} = 50\text{ V}, I_{DQ} = 1.0\text{ A}, P_{in} = 34\text{ dBm CW}$
Drain Efficiency <sup>4</sup>	$\eta$	-	73	-	%	$V_{DD} = 50\text{ V}, I_{DQ} = 1.0\text{ A}, P_{in} = 34\text{ dBm CW}$
Output Mismatch Stress	VSWR	-	-	3 : 1	$\Psi$	No damage at all phase angles, $V_{DD} = 50\text{ V}, I_{DQ} = 1.0\text{ A}, P_{OUT} = 180\text{ W CW}$
<b>Dynamic Characteristics</b>						
Input Capacitance	$C_{GS}$	-	57.8	-	pF	$V_{DS} = 50\text{ V}, V_{GS} = -8\text{ V}, f = 1\text{ MHz}$
Output Capacitance	$C_{DS}$	-	13.7	-	pF	$V_{DS} = 50\text{ V}, V_{GS} = -8\text{ V}, f = 1\text{ MHz}$
Feedback Capacitance	$C_{GD}$	-	1.23	-	pF	$V_{DS} = 50\text{ V}, V_{GS} = -8\text{ V}, f = 1\text{ MHz}$

Notes:

<sup>1</sup> Measured on wafer prior to packaging.

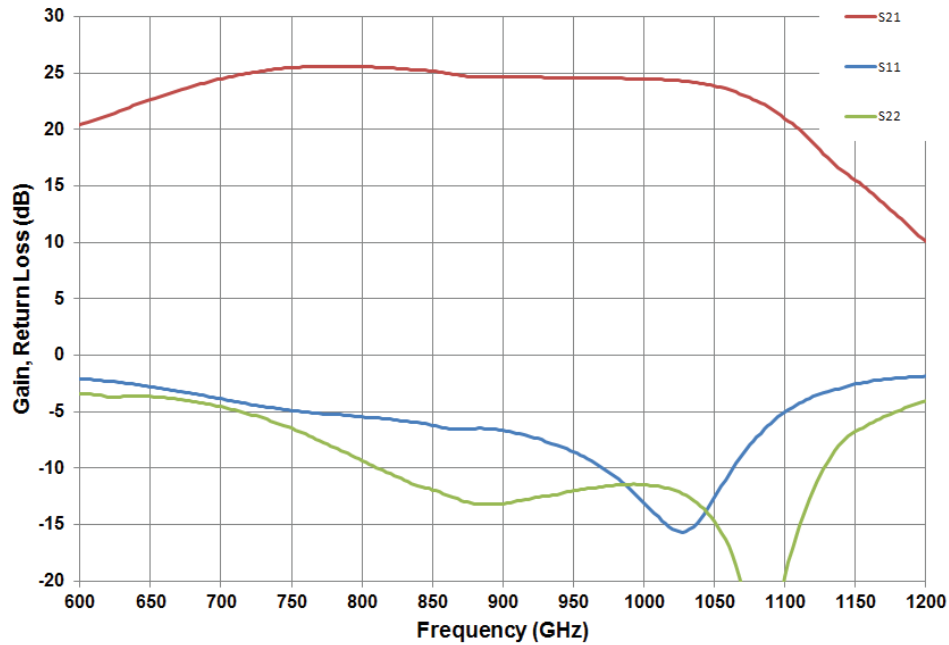
<sup>2</sup> Scaled from PCM data.

<sup>3</sup> Measurements are to be performed using Cree production test fixture AD-838292F-TB

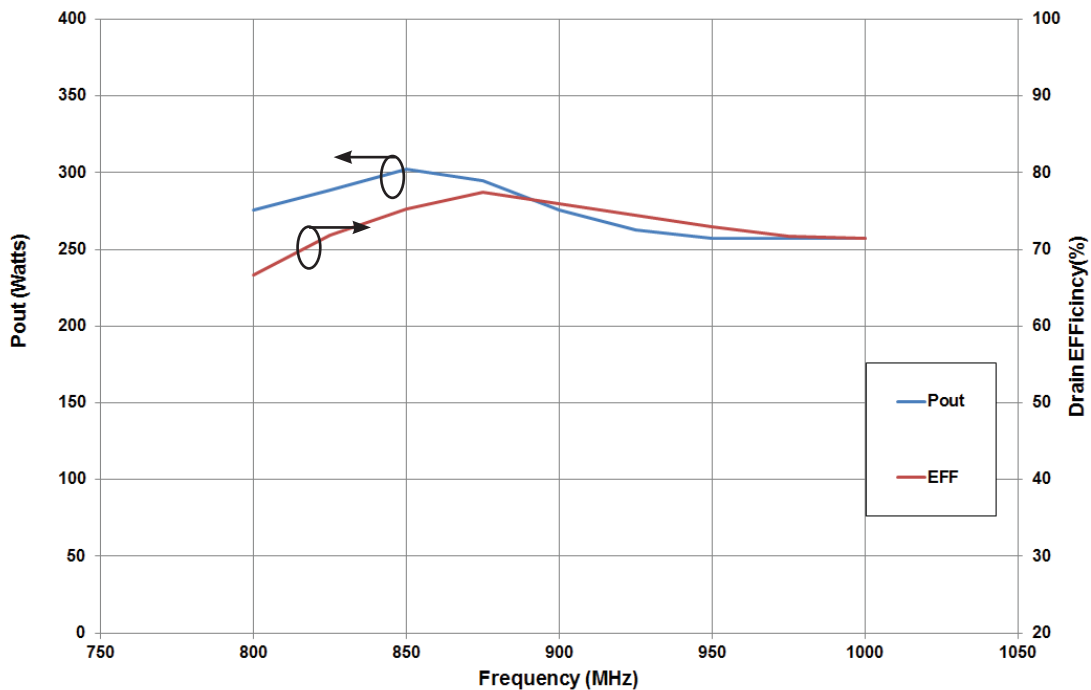
<sup>4</sup> Drain Efficiency =  $P_{OUT}/PDC$

## CGHV40180F Typical Performance

**Figure 1. - Small Signal Gain and Return Loss versus Frequency**  
 measured in application circuit CGHV40180F  
 $V_{DD} = 50\text{ V}$ ,  $I_{DQ} = 1.0\text{ A}$

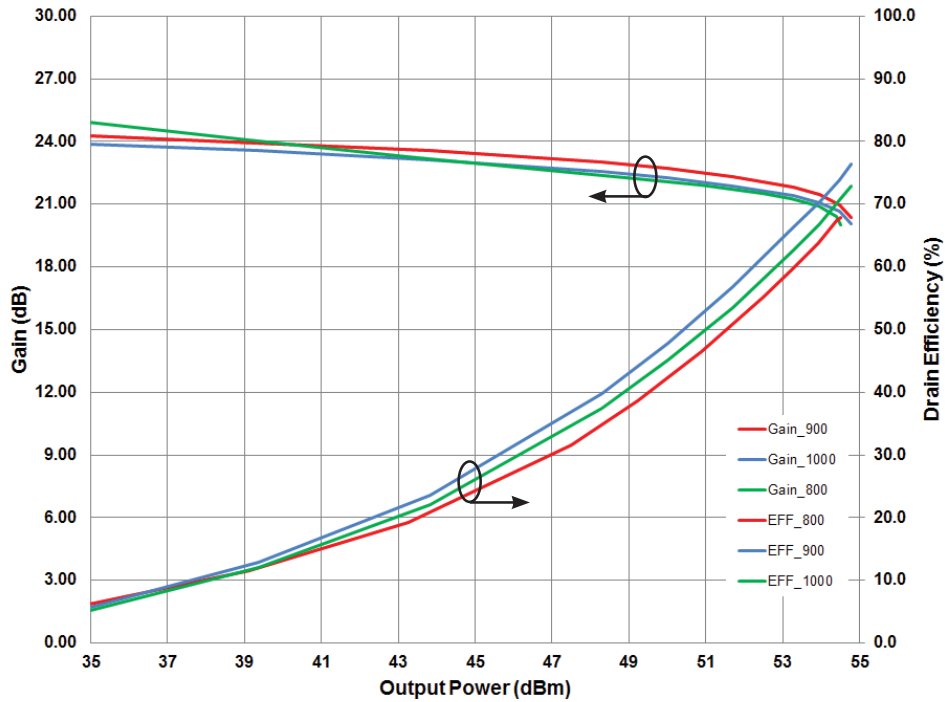


**Figure 2. - Output Power and Drain Efficiency vs Frequency**  
 CGHV40180F-TB  
 CW Operation,  $V_{DD} = 50\text{ V}$ ,  $I_{DQ} = 1.0\text{ A}$ , @  $P_{IN} 34\text{ dBm}$

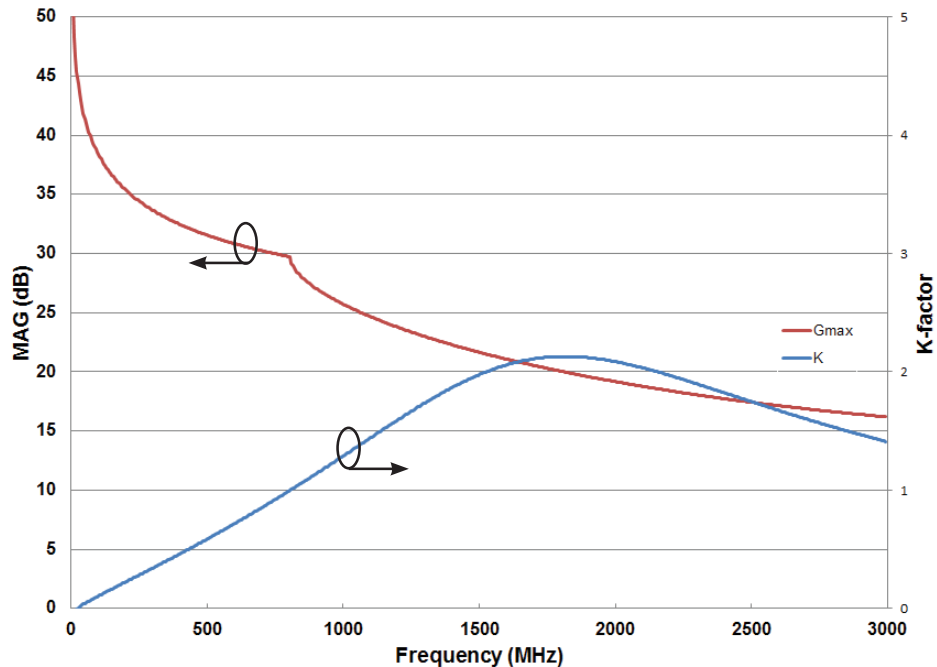


## CGHV40180F Typical Performance

**Figure 3. - Gain and Drain EFF vs. Frequency and Output Power**  
**CGHV40180F-TB**  
**CW Operation,  $V_{DD} = 50\text{ V}$ ,  $I_{DQ} = 1.0\text{ A}$**

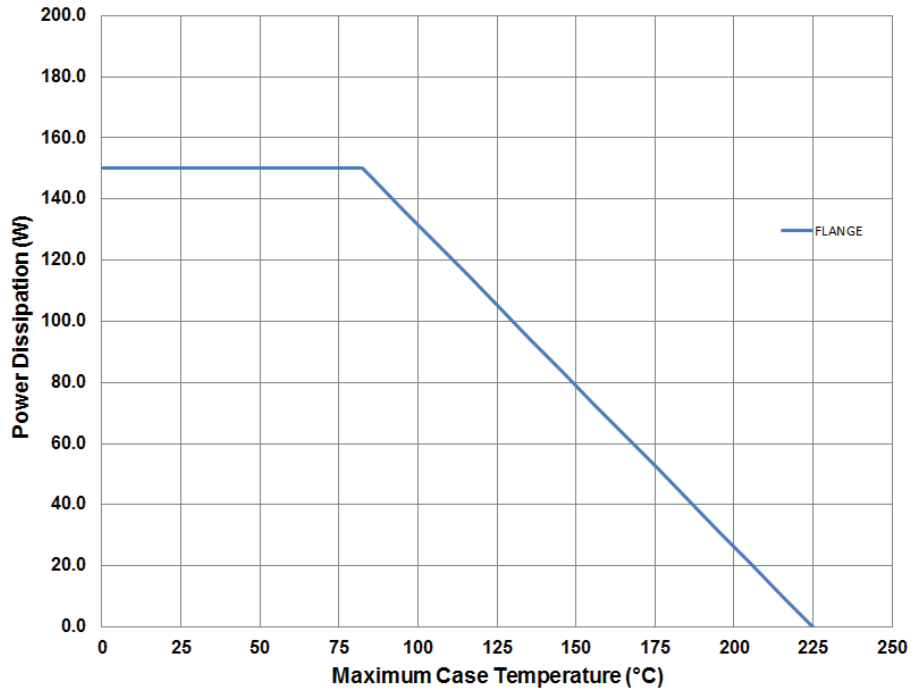


**Figure 4. - Simulated Maximum Available Gain and K-factor of the CGHV40180F**  
 $V_{DD} = 50\text{ V}$ ,  $I_{DQ} = 1.0\text{ A}$

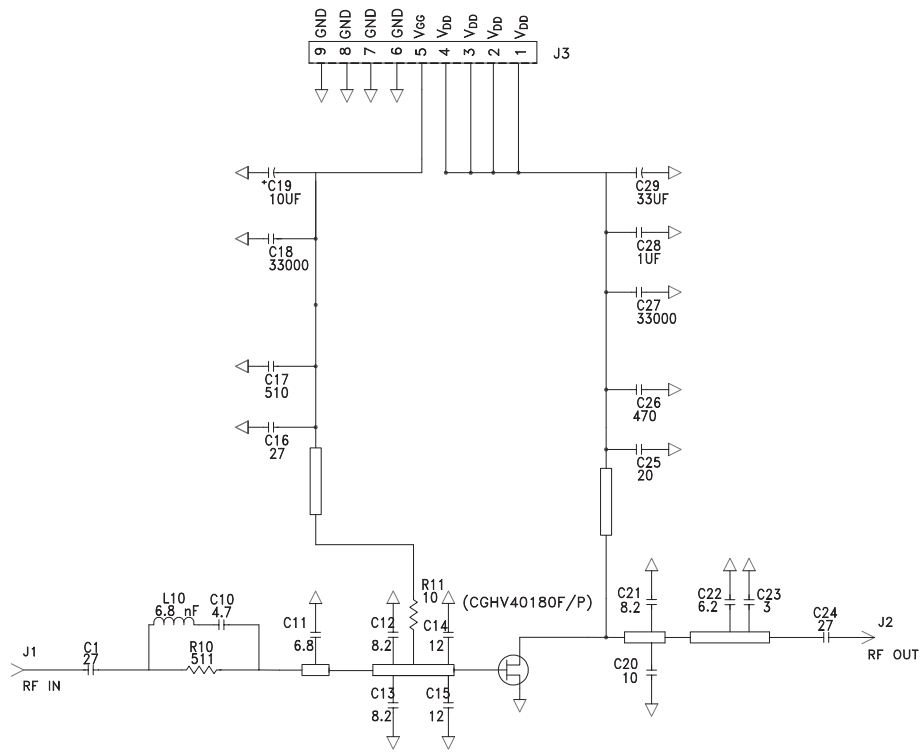


## CGHV40180F Power Dissipation De-rating Curve

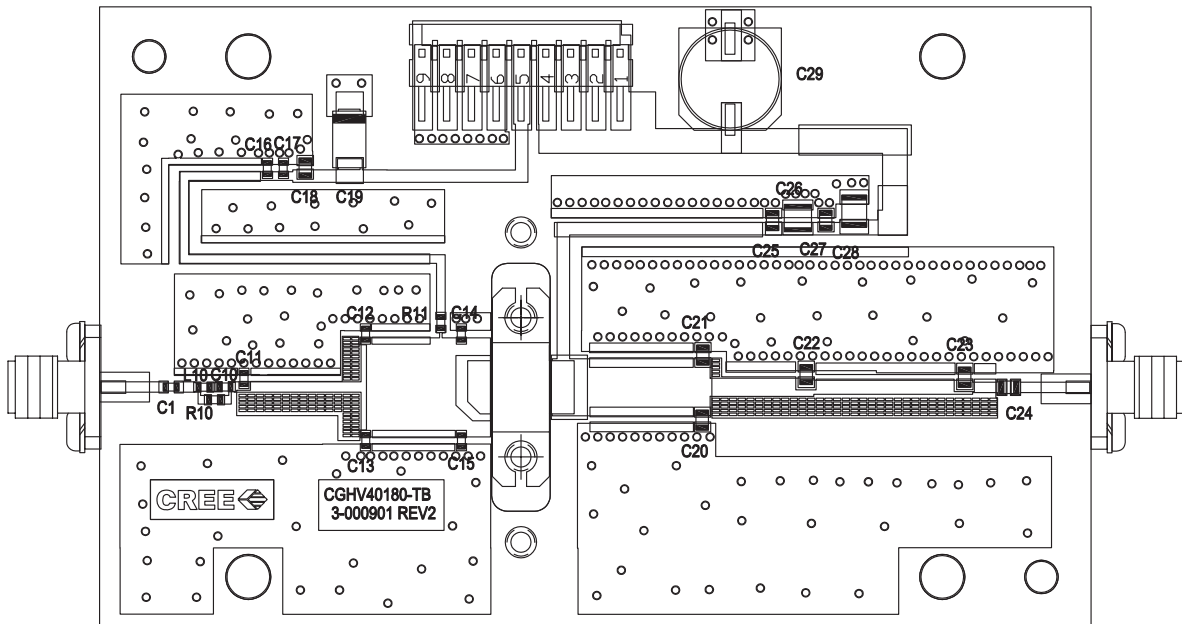
Figure 5. - Transient Power Dissipation De-rating Curve



## CGHV40180F-AMP Application Circuit Schematic



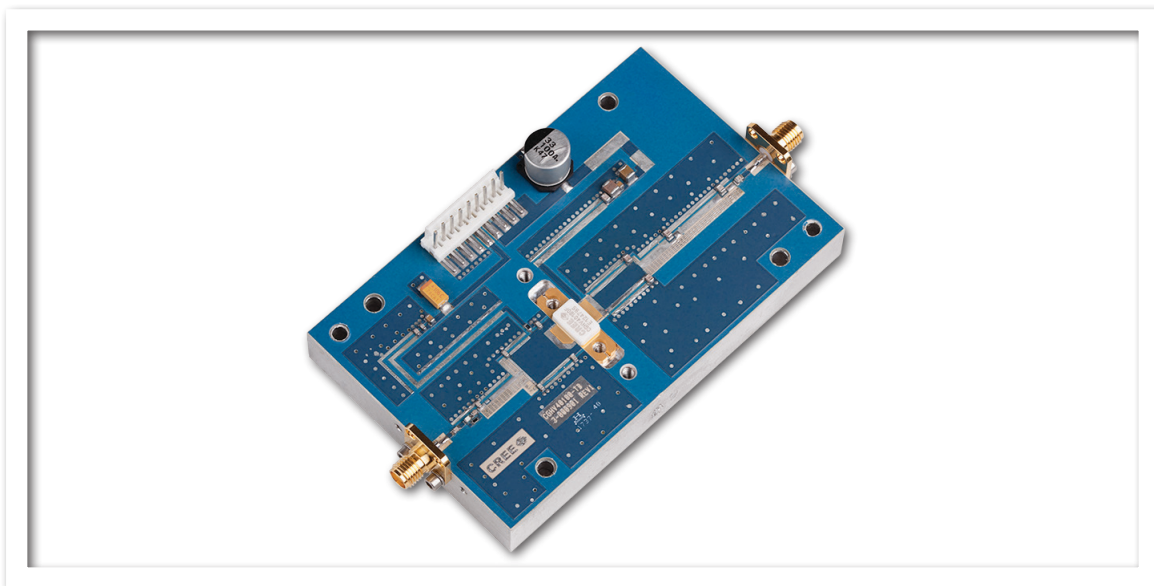
## CGHV40180F-AMP Application Circuit



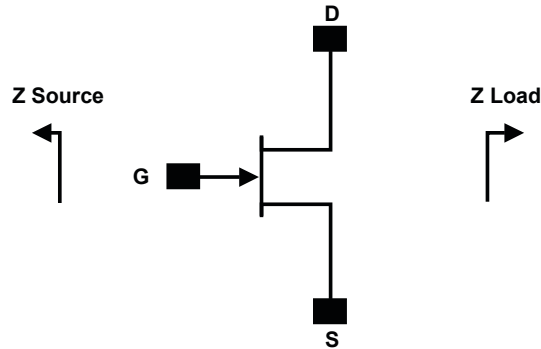
## CGHV40180F-AMP Application Circuit Bill of Materials

Designator	Description	Qty
R11	RES, 1/16W, 0603, 1%, 10.0 OHMS	1
R10	RES, 1/16W, 0603, 1%, 511 OHMS	1
C29	CAP, 33UF, 20%, G CASE	1
C28	CAP 1.0UF, 100V, ±10%, X7R, 1210	1
C17	CAP, 510pF, NPO, 5%, 100V, 0603	1
C26	CAP, 470pF, NPO, 5%, 250V, ATC800B	1
C19	CAP, 10UF, 16V TANTALUM, 2312	1
C14, C15	CAP, 12.0pF, ±5%, 0603, ATC600S	2
C1, C16	CAP, 27pF, ±5%, 0603, ATC600S	2
C10	CAP, 4.7pF, ±0.1pF, 0603, ATC600S	1
C11	CAP, 6.8pF, ±0.25pF, 0603, ATC600S	1
C12, C13	CAP, 8.2pF, ±0.25 pF, 0603, ATC600S	2
C18, C27	CAP, 33000pF, 0805, 100V, X7R	2
C20	CAP, 10pF, ±1%, 250V, 0805, ATC600F	2
C25	CAP, 20pF, ±5%, 250V, 0805, ATC600F	1
C24	CAP, 27pF, ±5%, 250V, 0805, ATC600F	1
C23	CAP, 3.0pF, ±0.1pF, 250V, 0805, ATC600F	2
C22	CAP, 6.2pF, ±0.1pF, 250V, 0805, ATC600F	1
C21	CAP, 8.2pF, ±0.1pF, 250V, 0805 ATC600F	1
-	PCB ROGERS HTC6035, 0.020 THK, ER 3.60	1
J1, J2	CONN, SMA, PANEL MOUNT JACK, FLANGE, 4 HOLE BLUNT POST	2
J3	HEADER RT>PLZ .1CEN LK 9POS	1
L10	INDUCTOR, CHIP, 6.8nH, 5%, 0603 SMT, DIGIKEY 712-1432-1-ND	1
Q1	CGHV40180	1

## CGHV40180F-AMP Demonstration Amplifier Circuit



## Source and Load Impedances



Frequency (MHz)	Z Source	Z Load
50	23.7 + J25.9	7.6 + J0.6
150	7.4 + J8.3	8.1 + J0.7
250	4.2 + J7.9	7.9 + J2.2
500	1.4 + J1.5	4.7 + J2.7
750	1.0 + J0.0	3.9 + J2.3
1000	0.7 + J1.1	4.0 + J1.8

Note 1.  $V_{DD} = 50\text{ V}$ ,  $I_{DQ} = 1.0\text{ A}$  in the 440223 package.

Note 2. Optimized for Power Gain,  $P_{SAT}$  and Drain Efficiency

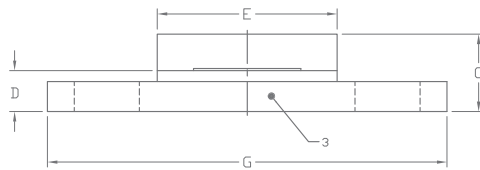
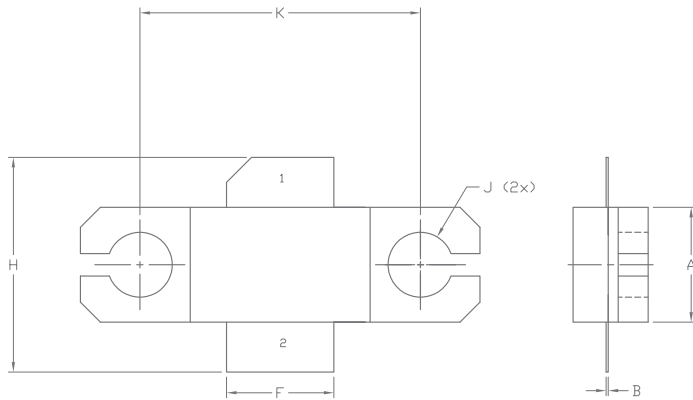
Note 3. When using this device at low frequency, series resistor should be used to maintain amplifier stability

## Electrostatic Discharge (ESD) Classifications

Parameter	Symbol	Class	Test Methodology
Human Body Model	HBM	1A (> 250 V)	JEDEC JESD22 A114-D
Charge Device Model	CDM	2 (125 V to 250 V)	JEDEC JESD22 C101-C



## Product Dimensions CGHV40180F (Package Type – 440223)



**NOTES:**

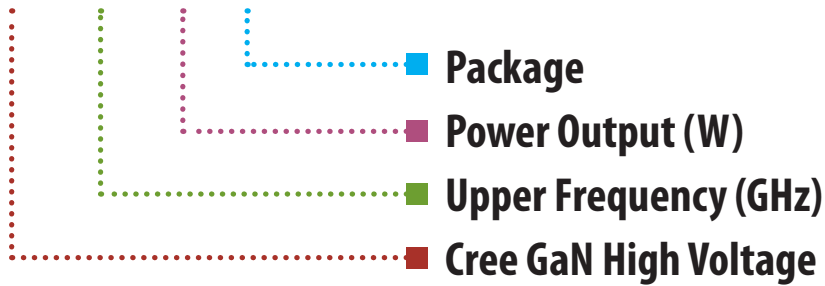
1. DIMENSIONING AND TOLERANCING PER ANSI Y14.5M, 1982.
2. CONTROLLING DIMENSION: INCH.
3. ADHESIVE FROM LID MAY EXTEND A MAXIMUM OF 0.020" BEYOND EDGE OF LID.
4. LID MAY BE MISALIGNED TO THE BODY OF THE PACKAGE BY A MAXIMUM OF 0.008" IN ANY DIRECTION.
5. ALL PLATED SURFACES ARE Ni/AU.

DIM	INCHES		MILLIMETERS	
	MIN	MAX	MIN	MAX
A	0.225	0.235	5.72	5.97
B	0.004	0.006	0.10	0.15
C	0.145	0.165	3.68	4.19
D	0.077	0.087	1.96	2.21
E	0.355	0.365	9.02	9.27
F	0.210	0.220	5.33	5.59
G	0.795	0.805	20.19	20.45
H	0.400	0.460	10.16	11.68
J	∅ .130		3.30	
k	0.562		14.27	

PIN 1. GATE  
 PIN 2. DRAIN  
 PIN 3. SOURCE

## Part Number System

# CGHV40180F



Parameter	Value	Units
Upper Frequency <sup>1</sup>	4.0	GHz
Power Output	100	W
Package	Flange	-


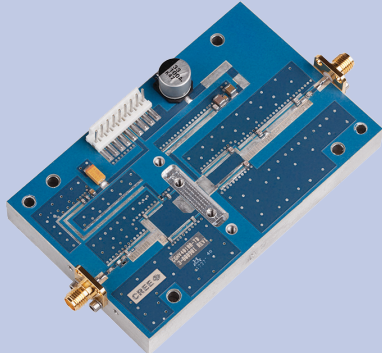
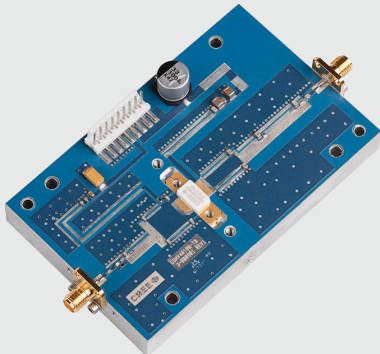
**Table 1.**

**Note<sup>1</sup>:** Alpha characters used in frequency code indicate a value greater than 9.9 GHz. See Table 2 for value.

Character Code	Code Value
A	0
B	1
C	2
D	3
E	4
F	5
G	6
H	7
J	8
K	9
Examples:	1A = 10.0 GHz 2H = 27.0 GHz

**Table 2.**

## Product Ordering Information

Order Number	Description	Unit of Measure	Image
CGHV40180F	GaN HEMT	Each	
CGHV40180F-TB	Test board without GaN HEMT	Each	
CGHV40180F-AMP	Test board with GaN HEMT (flanged) installed	Each	



## Disclaimer

Specifications are subject to change without notice. Cree, Inc. believes the information contained within this data sheet to be accurate and reliable. However, no responsibility is assumed by Cree for any infringement of patents or other rights of third parties which may result from its use. No license is granted by implication or otherwise under any patent or patent rights of Cree. Cree makes no warranty, representation or guarantee regarding the suitability of its products for any particular purpose. "Typical" parameters are the average values expected by Cree in large quantities and are provided for information purposes only. These values can and do vary in different applications and actual performance can vary over time. All operating parameters should be validated by customer's technical experts for each application. Cree products are not designed, intended or authorized for use as components in applications intended for surgical implant into the body or to support or sustain life, in applications in which the failure of the Cree product could result in personal injury or death or in applications for planning, construction, maintenance or direct operation of a nuclear facility.

For more information, please contact:

Cree, Inc.  
4600 Silicon Drive  
Durham, North Carolina, USA 27703  
[www.cree.com/RF](http://www.cree.com/RF)

Sarah Miller  
Marketing  
Cree, RF Components  
1.919.407.5302

Ryan Baker  
Marketing & Sales  
Cree, RF Components  
1.919.407.7816

Tom Dekker  
Sales Director  
Cree, RF Components  
1.919.407.5639



## Стандарт Электрон Связь

Мы молодая и активно развивающаяся компания в области поставок электронных компонентов. Мы поставляем электронные компоненты отечественного и импортного производства напрямую от производителей и с крупнейших складов мира.

Благодаря сотрудничеству с мировыми поставщиками мы осуществляем комплексные и плановые поставки широчайшего спектра электронных компонентов.

Собственная эффективная логистика и склад в обеспечивает надежную поставку продукции в точно указанные сроки по всей России.

Мы осуществляем техническую поддержку нашим клиентам и предпродажную проверку качества продукции. На все поставляемые продукты мы предоставляем гарантию .

Осуществляем поставки продукции под контролем ВП МО РФ на предприятия военно-промышленного комплекса России , а также работаем в рамках 275 ФЗ с открытием отдельных счетов в уполномоченном банке. Система менеджмента качества компании соответствует требованиям ГОСТ ISO 9001.

Минимальные сроки поставки, гибкие цены, неограниченный ассортимент и индивидуальный подход к клиентам являются основой для выстраивания долгосрочного и эффективного сотрудничества с предприятиями радиоэлектронной промышленности, предприятиями ВПК и научно-исследовательскими институтами России.

С нами вы становитесь еще успешнее!

### Наши контакты:

**Телефон:** +7 812 627 14 35

**Электронная почта:** [sales@st-electron.ru](mailto:sales@st-electron.ru)

**Адрес:** 198099, Санкт-Петербург,  
Промышленная ул, дом № 19, литера Н,  
помещение 100-Н Офис 331