

---

## 3ch DC/DC for TFT LCD

---

NO.EA-154-150723

### OUTLINE

The R1290 series are the optimized DC/DC converter ICs for TFT LCD displays. Each of the R1290 series contains one PWM step-up DC/DC converter controller and two diode charge-pump controllers. The charge-pumps can control a boost output and a negative output and have the output voltage regulation function with external resistors.

The power on sequence can be made with setting the delay time with external capacitors for each charge pump channel.

### FEATURES

- Operating Voltage Range ..... 2.0V ~ 5.5V
- Step-up DC/DC controller part
  - Internal 2A capability Nch MOSFET Driver ( $R_{ON}=150m\Omega$  Typ.)
  - Over Current Protection Function
  - Adjustable  $V_{OUT}$  up to 20V with external resistors
  - Adjustable Phase compensation with external components
  - Max duty adjustable with external resistors for DTC pin
  - Soft-start time adjustable with external capacitor for SS pin
  - Oscillator Frequency: Adjustable frequency with resistors (180kHz~1400kHz)
- Charge-pump part
  - Adjustable output voltage with external resistors
  - Sequence function: Charge-pump turns on after the main step-up converter voltage outputs. The positive charge-pump and the negative charge-pump turn on sequence control is possible with setting delay time for each channel
  - Oscillator Frequency: 1/4 of the main step-up DCDC converter oscillator frequency
- Controller part
  - Under Voltage Lock-Out (UVLO: selectable detector threshold from 1.8V, 2.2V or 2.8V)
  - Reference voltage ( $V_{REF}$ : Typ.1.2V)
  - Short Protection with timer latch function (adjustable delay time with external capacitor)
    - : Shutdown all the outputs if at least one of three outputs is short to the GND.
  - Stand-by function by CE pin
- Package
  - Thin 24-pin Package QFN0404-24

### APPLICATIONS

- Power source for hand-held equipment
- Power source for LCD and CCD

## BLOCK DIAGRAM



## SELECTION GUIDE

The UVLO threshold voltage can be selected at the user's request .  
 The selection can be available by designating the part number as shown below,

Product Name	Package	Quantity per Reel	Pb Free	Halogen Free
R1290K10xA-E2	QFN0404-24	1,000 pcs	○	○
x : Designation of UVLO threshold 1 : 1.8V 2 : 2.2V 3 : 2.8V				

## PIN ASSIGNMENT

<TOP VIEW>



## PIN DESCRIPTIONS

Pin No.	Symbol	Description
1	PGND	Power GND Pin
2	PGND	Power GND Pin
3	AGND	Analog GND Pin
4	VIN	Power Input Pin
5	VREF	Reference Voltage Output Pin
6	CE	Chip Enable Pin
7	VFB	Step-Up DC/DC Feedback Pin
8	SS	Step-Up DC/DC Soft-Start Pin
9	TST	TEST Pin
10	DTC	Step-up DC/DC Max-Duty Setting Pin
11	DELAY	Short Protection Delay Setting Pin
12	AMPOUT	Amplifier Output Pin For Phase Compensation
13	RT	Oscillator Frequency Setting Pin
14	CPNDLY	Negative Charge-Pump Delay Setting Pin
15	CPNFB	Negative Charge-Pump Feedback Pin
16	CPPDLY	Positive Charge-Pump Delay Setting Pin
17	CPPFB	Positive Charge-Pump Feedback Pin
18	CPGND	Charge-Pump GND Pin
19	CPN	Negative Charge-Pump Driver Output Pin
20	CPVCC	Power Pin for Charge-Pump
21	CPP	Positive Charge-Pump Driver Output Pin
22	CPPSW	Output Control Pin for Positive Charge-Pump
23	LX	Step-up DC/DC Driver Output Pin
24	LX	Step-up DC/DC Driver Output Pin

\* Tab is GND level. (They are connected to the reverse side of this IC.) The tab is better to be connected to the GND, but leaving it open is also acceptable.

## ABSOLUTE MAXIMUM RATINGS

(GND=0V)

Symbol	Item	Ratings	Unit
$V_{IN}$	$V_{IN}$ pin voltage	6.5	V
$V_{DTC}$	DTC pin voltage	- 0.3 ~ $V_{IN} + 0.3$	V
$V_{FB}$	VFB pin voltage	- 0.3 ~ $V_{IN} + 0.3$	V
$V_{SS}$	SS pin voltage	- 0.3 ~ $V_{IN} + 0.3$	V
$V_{DELAY}$	DELAY pin voltage	- 0.3 ~ $V_{IN} + 0.3$	V
$V_{AMP}$	AMPOUT pin voltage	- 0.3 ~ $V_{IN} + 0.3$	V
$V_{LX}$	LX pin voltage	- 0.3 ~ 24	V
$I_{LX}$	LX pin current	Internally limited	A
$V_{REF}$	VREF pin voltage	- 0.3 ~ $V_{IN} + 0.3$	V
$V_{CPVCC}$	CPVCC pin voltage	- 0.3 ~ 24	V
$V_{CE}$	CE pin voltage	- 0.3 ~ $V_{IN} + 0.3$	V
$V_{RT}$	RT pin voltage	- 0.3 ~ $V_{IN} + 0.3$	V
$V_{CPPDLY}$	CPPDLY pin voltage	- 0.3 ~ $V_{IN} + 0.3$	V
$V_{CPNDLY}$	CPNDLY pin voltage	- 0.3 ~ $V_{IN} + 0.3$	V
$V_{PFB}$	CPPFB pin voltage	- 0.3 ~ $V_{IN} + 0.3$	V
$V_{NFB}$	CPNFB pin voltage	- 0.3 ~ $V_{IN} + 0.3$	V
$V_{CPP}$	CPP pin voltage	- 0.3 ~ 24	V
$V_{CPN}$	CPN pin voltage	- 0.3 ~ 24	V
$V_{PSW}$	CPPSW pin voltage	- 0.3 ~ 24	V
$I_{PSW}$	CPPSW pin current	20	mA
$P_D$	Power dissipation (QFN0404-24)* -A	670	W
	Power dissipation (QFN0404-24)* -B	800	
	Power dissipation (QFN0404-24)* -C	1500	
$T_a$	Operating Temperature Range	- 40 ~ + 95	°C
$T_{stg}$	Storage Temperature Range	- 55 ~ + 125	°C
$T_{jmax}$	Maximum Junction Temperature	+ 125	°C

\* ) For Power Dissipation, please refer to PACKAGE INFORMATION to be described.

### ABSOLUTE MAXIMUM RATINGS

Electronic and mechanical stress momentarily exceeded absolute maximum ratings may cause the permanent damages and may degrade the life time and safety for both device and system using the device in the field. The functional operation at or over these absolute maximum ratings is not assured.

### RECOMMENDED OPERATING CONDITIONS (ELECTRICAL CHARACTERISTICS)

All of electronic equipment should be designed that the mounted semiconductor devices operate within the recommended operating conditions. The semiconductor devices cannot operate normally over the recommended operating conditions, even if when they are used over such conditions by momentary electronic noise or surge. And the semiconductor devices may receive serious damage when they continue to operate over the recommended operating conditions.

## ELECTRICAL CHARACTERISTICS

\*Setting  $V_{IN}$  is depending upon the version as shown below, unless otherwise noted;

R1290K101A  $V_{IN}=2.5V$

R1290K102A  $V_{IN}=2.5V$

R1290K103A  $V_{IN}=3.5V$

( $T_a=25^{\circ}C$ )

Symbol	Parameter	Conditions	Min.	Typ.	Max.	Unit
$V_{IN}$	Operating Input Voltage	R1290K101A	2.0		5.5	V
		R1290K102A	2.5		5.5	
		R1290K103A	3.3		5.5	
$I_{IN}$	$V_{IN}$ Supply Current	$V_{IN}=5.5V$ , $R_T=24k\Omega$		3.5		mA
$V_{UVLO1}$	UVLO Detect Voltage ( $V_{IN}$ Falling )	R1290K101A	1.7	1.8	1.9	V
		R1290K102A	2.05	2.2	2.35	
		R1290K103A	2.6	2.8	3.0	
$V_{UVLO2}$	UVLO Release Voltage ( $V_{IN}$ Rising )	R1290K101A		$V_{UVLO1}+0.09$	2.0	V
		R1290K102A		$V_{UVLO1}+0.15$	2.5	
		R1290K103A		$V_{UVLO1}+0.22$	3.2	
$V_{FB}$	$V_{FB}$ Voltage		0.985	1.000	1.015	V
$\frac{\Delta V_{FB}}{\Delta T}$	$V_{FB}$ Voltage Temperature Coefficient	$-40^{\circ}C \leq T_a \leq +95^{\circ}C$		$\pm 150$		ppm/ $^{\circ}C$
$V_{FBL}$	$V_{FB}$ Fault Voltage			$V_{FB} \times 0.85$		V
$I_{FB}$	$V_{FB}$ Input Current	$V_{IN}=5.5V$ $V_{FB}=0V$ or $5.5V$	-0.1		0.1	$\mu A$
$V_{DTC0}$	Duty=0% DTC Voltage	$R_T=24k\Omega$	0.27	0.37	0.47	V
$V_{DTC20}$	Duty=20% DTC Voltage	$R_T=24k\Omega$		0.49		V
$V_{DTC80}$	Duty=80% DTC Voltage	$R_T=24k\Omega$		0.91		V
Maxduty	Maximum Duty Limit	$R_T=24k\Omega$ , $V_{DTC}=V_{IN}$	86	91	96	%
$I_{AMPH}$	AMP"H" Output Current	$V_{FB}=0.9V$	1.6	3.2	5.8	mA
$I_{AMPL}$	AMP"L" Output Current	$V_{FB}=1.1V$	40	80	120	$\mu A$
$R_{ON}$	Switch ON Resistance			150		m $\Omega$
$I_{LXOFF}$	Leakage Current	$V_{IN}=5.5V$ , $V_{LX}=20V$			5	$\mu A$
$I_{LIMDC}$	Switch Limit Current		2.0			A
$f_{REQ}$	Oscillator Frequency	$R_T=110k\Omega$	100	180	260	kHz
		$R_T=24k\Omega$	600	700	800	kHz
		$R_T=10k\Omega$	1.2	1.4	1.6	MHz
$V_{REF}$	$V_{REF}$ Voltage		1.182	1.200	1.218	V
$\frac{\Delta V_{REF}}{\Delta T}$	$V_{REF}$ Voltage Temperature Coefficient			150		ppm/ $^{\circ}C$
$I_{OUT}$	$V_{REF}$ Maximum Output Current		2.0			mA

(Ta=25°C)

Symbol	Parameter	Conditions		Min.	Typ.	Max.	Unit
$\frac{\Delta V_{REF}}{\Delta V_{IN}}$	V <sub>REF</sub> Line Regulation	101A	V <sub>IN</sub> =2.0~5.5V		5	10	mV
		102A	V <sub>IN</sub> =2.5~5.5V				
		103A	V <sub>IN</sub> =3.3~5.5V				
$\frac{\Delta V_{REF}}{\Delta I_{OUT}}$	V <sub>REF</sub> Load Regulation	I <sub>OUT</sub> =0.1mA ~ 2.0mA			6	20	mV
I <sub>LIM</sub>	Short Current Limit				15		mA
CPVCC	CPVCC Operating Voltage			6		20	V
I <sub>CPVCC</sub>	CPVCC Supply Current	CPVCC=9V, T=24kΩ			500		μA
I <sub>SS</sub>	Soft-Start Current	CPVCC=9V		2.5	5.0	7.5	μA
t <sub>PSS</sub>	CPP Soft-Start Time	CPVCC=9V			4.0		ms
t <sub>NSS</sub>	CPN Soft-Start Time	CPVCC=9V			4.0		ms
I <sub>PDLY</sub>	CPPDLY Charge Current	CPVCC=9V		2.5	5.0	7.5	μA
I <sub>NDLY</sub>	CPNDLY Charge Current	CPVCC=9V		2.5	5.0	7.5	μA
V <sub>PDLY</sub>	CPPDLY Detector Threshold	CPVCC=9V		0.95	1.00	1.05	V
V <sub>NDLY</sub>	CPNDLY Detector Threshold	CPVCC=9V		0.95	1.00	1.05	V
V <sub>PFB</sub>	CPPFB Voltage	CPVCC=9V		1.475	1.500	1.525	V
$\frac{\Delta V_{PFB}}{\Delta T}$	CPPFB Voltage Temperature Coefficient	CPVCC=9V -40°C ≤ Ta ≤ 95°C			150		ppm/°C
V <sub>NFB</sub>	CPNFB Voltage	CPVCC=9V		-0.03	0.00	0.03	V
V <sub>PFBL</sub>	CPPFB Fault Voltage	CPVCC=9V			V <sub>PFB</sub> × 0.85		V
V <sub>NFBL</sub>	CPNFB Fault Voltage	CPVCC=9V			0.15		V
R <sub>CPPH</sub>	CPP"H"ON Resistance	CPVCC=9V			5		Ω
R <sub>CPPL</sub>	CPP"L"ON Resistance	CPVCC=9V			10		Ω
R <sub>CPNH</sub>	CPN"H"ON Resistance	CPVCC=9V			5		Ω
R <sub>CPNL</sub>	CPN"L"ON Resistance	CPVCC=9V			10		Ω
f <sub>REQCP</sub>	Charge-pump Frequency	CPVCC=9V			f <sub>REQ</sub> /4		kHz
I <sub>DELAY1</sub>	DELAY Charge Current	CPVCC=9V		2.5	5.0	7.5	μA
I <sub>DELAY2</sub>	DELAY Discharge Current	CPVCC=9V			200		μA
V <sub>DELAY</sub>	DELAY Detector Threshold	CPVCC=9V		0.95	1.00	1.05	V
V <sub>PSW</sub>	CPPSW"L" Output Voltage	CPVCC=9V, I=1mA			0.2		V
I <sub>standby1</sub>	Standby Current	V <sub>IN</sub> =5.5V			0.1	5	μA
I <sub>standby2</sub>	CPVCC standby current	CPVCC=20V			0.1	5	μA
V <sub>CEL</sub>	CE"L" Input Voltage	101A	V <sub>IN</sub> =2.0V			0.3	V
		102A	V <sub>IN</sub> =2.5V				
		103A	V <sub>IN</sub> =3.3V				
V <sub>CEH</sub>	CE"H" Input Voltage	V <sub>IN</sub> =5.5V		1.5			V

# TYPICAL APPLICATION

Typical Application 1



Typical Application 2



< components >

L	NR4018T220M(for 180KHz) NR4018T4R7M(for700KHz) NR4018T2R2M(for1.4MHz)	Taiyo Yuden
D1	CRS10I30A	Toshiba
D2-D7	1SS374	Toshiba
Tr1	2SA1586	Toshiba (All capacitors are ceramic type.)



## TEST CIRCUIT

### V<sub>OUT1</sub>(DCDC)

- Output Voltage VS. Output Current
- Efficiency VS. Output Current

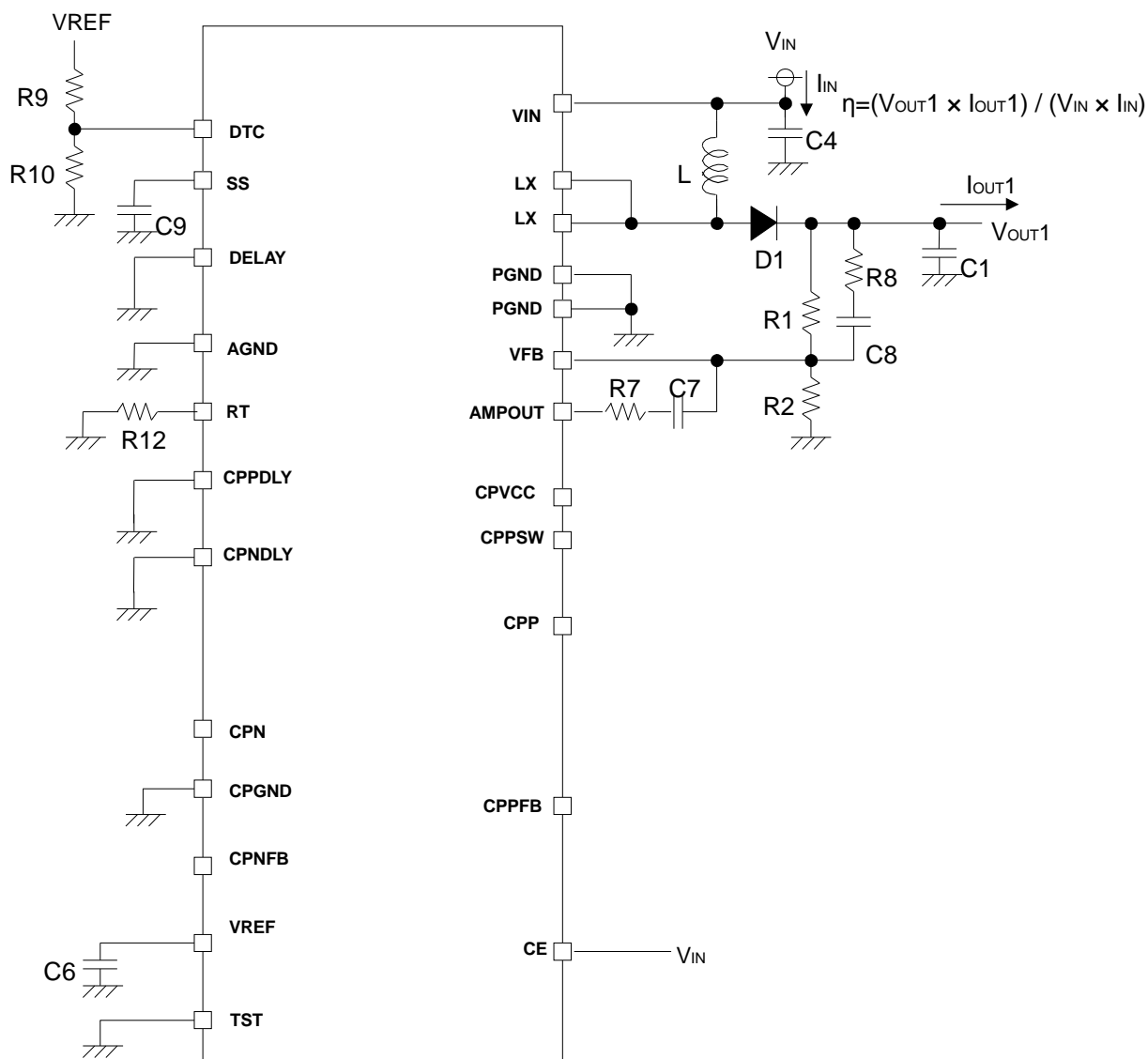

---

**R1290x**

---

&lt; components &gt;

(1)  $f_{osc}=180\text{kHz}$ 

R1	For setting voltage of $V_{OUT1}$	C1	4.7 $\mu$ F(ceramic)
R2	For setting voltage of $V_{OUT2}$	C4	4.7 $\mu$ F(ceramic)
R7	10k $\Omega$	C6	1 $\mu$ F(ceramic)
R8	4.7k $\Omega$	C7	1000pF(ceramic)
R9	20k $\Omega$	C8	1000pF( $V_{OUT1}=8\text{V}$ ) (ceramic)
R10	100k $\Omega$		560pF( $V_{OUT1}=12\text{V}$ ) (ceramic)
R12	110k $\Omega$		270pF( $V_{OUT1}=18\text{V}$ ) (ceramic)
		C9	0.022 $\mu$ F(ceramic)
Inductor	NR4018T220M(Taiyo Yuden:22 $\mu$ H)		
Diode	CRS10I30A (Toshiba)		

(2)  $f_{osc}=700\text{kHz}$ 

R1	For setting voltage of $V_{OUT1}$	C1	4.7 $\mu$ F(ceramic)
R2	For setting voltage of $V_{OUT2}$	C4	4.7 $\mu$ F(ceramic)
R7	4.7k $\Omega$	C6	1 $\mu$ F(ceramic)
R8	4.7k $\Omega$	C7	1000pF(ceramic)
R9	20k $\Omega$	C8	1000pF( $V_{OUT1}=8\text{V}$ ) (ceramic)
R10	100k $\Omega$		560pF( $V_{OUT1}=12\text{V}$ ) (ceramic)
R12	24k $\Omega$		270pF( $V_{OUT1}=18\text{V}$ ) (ceramic)
		C9	0.022 $\mu$ F(ceramic)
Inductor	NR4018T4R7M (Taiyo Yuden:4.7 $\mu$ H)		
Diode	CRS10I30A (Toshiba)		

(3)  $f_{osc}=1400\text{kHz}$ 

R1	For setting voltage of $V_{OUT1}$	C1	4.7 $\mu$ F(ceramic)
R2	For setting voltage of $V_{OUT2}$	C4	4.7 $\mu$ F(ceramic)
R7	3.3k $\Omega$	C6	1 $\mu$ F(ceramic)
R8	4.7k $\Omega$	C7	1000pF(ceramic)
R9	20k $\Omega$	C8	1000pF( $V_{OUT1}=8\text{V}$ ) (ceramic)
R10	100k $\Omega$		560pF( $V_{OUT1}=12\text{V}$ ) (ceramic)
R12	10k $\Omega$		270pF( $V_{OUT1}=18\text{V}$ ) (ceramic)
		C9	0.022 $\mu$ F(ceramic)
Inductor	NR4018T2R2M (Taiyo Yuden:2.2 $\mu$ H)		
Diode	CRS10I30A (Toshiba)		

**V<sub>out2</sub>(Step-up Charge-pump part )**

- Output Voltage VS. Output Current
- Efficiency VS. Output Current

(1)CPVCC=8V, V<sub>out2</sub>=12V, CPVCC=12V, V<sub>out2</sub>=18V



< components >

R3	For setting voltage of V <sub>out3</sub>	C2	1μF(ceramic)
R4	For setting voltage of V <sub>out4</sub>	C4	4.7μF(ceramic)
R12	For setting of f <sub>osc</sub>	C5	4.7μF(ceramic)
		C6	1μF(ceramic)
		C13	For setting of C <sub>fly</sub> (ceramic)
Diode(D2-D3)	1SS374(Toshiba)		

**V<sub>OUT2</sub>(DCDC)**

- Output Voltage VS. Output Current
- Efficiency VS. Output Current

(2) CPVCC=8V, V<sub>OUT2</sub>=16V, CPVCC=12V, V<sub>OUT2</sub>=24V



< components >

R3	For setting voltage of V <sub>OUT3</sub>	C2	1μF(ceramic)
R4	For setting voltage of V <sub>OUT4</sub>	C4	4.7μF(ceramic)
R12	For setting of f <sub>osc</sub>	C5	4.7μF(ceramic)
		C6	1μF(ceramic)
		C13	For setting of C <sub>fly</sub> (ceramic)
		C15	For setting of C <sub>fly</sub> (ceramic)
		C16	1μF(ceramic)
Diode(D2-D3)		1SS374(Toshiba)	

### V<sub>OUT3</sub> (Inverting Charge-Pump Part)

- Output Voltage VS. Output Current
- Efficiency VS. Output Current



< components >

R5	For setting voltage of V <sub>OUT3</sub>	C2	1μF(ceramic)
R6	For setting voltage of V <sub>OUT4</sub>	C4	4.7μF(ceramic)
R12	For setting of f <sub>osc</sub>	C5	4.7μF(ceramic)
		C6	1μF(ceramic)
		C14	For setting of C <sub>fly</sub> (ceramic)
Diode(D2-D3)	1SS374(Toshiba)		

## TECHNICAL NOTE

### Setting Method for the Step-Up Converter Output Voltage

$V_{OUT1}$  of the step-up converter controls the voltage of  $V_{FB}$  pin, which should be  $V_{FB}=1.0V$ . It is possible to set  $V_{OUT1}$  voltage according to the next formula of  $R1$  and  $R2$  (refer to the Typical Application).  $V_{OUT1}$  voltage should be equal or less than 20V.  $R1+R2$  should be equal or less than 500k $\Omega$ .

$$V_{OUT1}=V_{FB} \times (R1+R2) / R2$$

### Setting Method for the Step-Up Charge-Pump Output Voltage

$V_{OUT2}$  of the positive charge pump controls the voltage of  $C_{PPFB}$  pin, which should be  $V_{PFB}=1.5V$ . It is possible to set  $V_{OUT2}$  voltage according to in the following formula of  $R3$  and  $R4$  (refer to the Typical Application).  $R3+R4$  should be equal or less than 500k $\Omega$ .

$$V_{OUT2} = V_{PFB} \times (R3 + R4) / R4$$

In the case of Typical Application 1, the maximum output voltage can be described as in the following formula.

$$V_{OUT2} (\text{max}) = CPVCC \times 2 - V_F \times 2 \quad (V_F \text{ is the forward voltage for the diodes D2-D3})$$

Set  $C15$ ,  $D6$  and  $D7$  of diodes, and  $C16$  (refer to the Typical Application 2) if the output voltage needs more than the range above. In this case, the maximum output voltage can be described as in the following formula.

$$V_{OUT2} (\text{max}) = CPVCC \times 3 - V_F \times 4 \quad (V_F \text{ is the forward voltage for diodes D2-D3, D6-D7})$$

NOTE: The maximum load current of the boost charge pump is determined by  $C_{fly}$  ( $C13$ ,  $C15$ ), the oscillator frequency of charge pump ( $f_{REQCP}$ ), and CPP "L" On Resistance ( $R_{CPPL}$ ) as described in the following formula.

$$I_{OUT2} (\text{max}) = C_{fly} \times (1 - \exp(-1 / (2 \times C_{fly} \times R_{CPPL} \times f_{REQCP}))) \times (CPVCC \times 2 - V_{OUT2} - V_F \times 2) \times f_{REQCP}$$

### Setting Method for the Inverting Charge-Pump Output Voltage

$V_{OUT3}$  of the inverting charge-pump controls the voltage of  $C_{PNFB}$  pin, which should be  $V_{NFB}=0V$ . It is possible to set  $V_{OUT3}$  voltage by the next formula by  $R5$  and  $R6$  that are between  $V_{REF}$  pin and  $V_{OUT3}$  (refer to the Typical Application).  $R5+R6$  should be equal or less than 500k $\Omega$

$$V_{OUT3} = V_{NFB} - (V_{REF} - V_{NFB}) \times R5 / R6$$

The minimum output voltage can be set by the following formula.

$$V_{OUT3} (\text{min}) = - (CPVCC - V_F \times 2) \quad (V_F \text{ is the forward voltage of the diode D4 and D5})$$

NOTE: The maximum load current of inverting charge pump is determined by  $C_{fly}$ ( $C14$ ), the oscillator frequency of charge pump ( $f_{REQCP}$ ), and CPN "L" ON Resistance ( $R_{CPNL}$ ) as described in the following formula.

$$I_{OUT3} (\text{max}) = C_{fly} \times (1 - \exp(-1 / (2 \times C_{fly} \times R_{CPNL} \times f_{REQCP}))) \times (CPVCC + V_{OUT3} - V_F \times 2) \times f_{REQCP}$$

## Setting Method for the Step-up DC/DC Converter's Phase Compensation

In the DC/DC converter, with the load current and the external components (L and C) the phase may be delay by 180 degree. Due to this, the phase margin of system is loss and stability would be worse. Thus, it is necessary to proceed the phase, and keep a certain phase margin. The pole is made with external components L and C.

$$F_{\text{pole}} \sim 1 / \{2 \times \pi \times \sqrt{L \times C1}\}$$

The phase compensation and the system gain can be set with using the resistor, R7 and capacitors, C7 and C8 (refer to the diagram p.8 and p.9). The position and the setting values shown in the previous page are one of the examples (refer to the Typical Application).

R7 and C7 make the zero point (the backward phase)

$$F_{\text{zero}} \sim 1 / (2 \times \pi \times R7 \times C7)$$

Select R7 and C7, so that the cutoff frequency of this Zero point may become approximately the cutoff frequency of pole made by the external components (L and C). For example, supposed that the L=10μH, C<sub>OUT</sub> (C1)=10μF, the cut-off frequency of the pole is approximately 16kHz. Then to make the cut-off frequency of the Zero point around 16kHz around, here, set R7=4.7kΩ and C7=2200pF.

The gain can be set with the ratio of the resistance of R7 and combined resistance of R1 and R2 (RT: RT=R1×R2/(R1+R2)). If R7 is larger than combined resistance (RT), the gain becomes high. If the gain is high, the characteristic of response will be improved but the operating stability will be worse. Select the appropriate value as R7.

In addition, R1 and C8 make the zero point (the backward phase).

$$F_{\text{zero}} \sim 1 / (2 \times \pi \times R1 \times C8)$$

Set this cutoff frequency of zero point at the lower frequency than the cut-off frequency by pole made by the external components (L and C).

## Method of Reducing Noise of the Feedback Voltage

When the system noise is large, output noise may be on to the feedback loop, and unstable operation may result. In this case, set the value of the resistance R1,R2,R3,R4,R5 and R6 low enough (refer to the diagram), make the noise into the feed-back reduce. It is possible to reduce the noise to the VFB pin by connecting the resistance in the range from 1kΩ to 5kΩ around as R8(refer to the diagram).

## Input Voltage

The range of voltage of V<sub>IN</sub> must be between 2.0V and 5.5V. It is possible to use CPVCC pin by input V<sub>OUT1</sub> or input another voltage of 6V~20V to CPVCC as a power supply. In that case, set a capacitor of 1.0μF or more as C16 between GND and CPVCC pin.

## Setting Method of Oscillator Frequency

Set a resistor (R12) between GND and RT pin. The oscillator frequency of the step-up converter (f<sub>REQ</sub>) can be set according to the next formula. This value depends upon the resistance value. Set the frequency in between 180kHz and 1400kHz.

$$f_{\text{REQ}} = 2.7 \times 10^{10} / [R12 \times \{0.66 + \sqrt{(0.66^2 + 10800 / R12)}\}]$$

The oscillator frequency of the charge-pump is one fourth of the oscillator frequency of the main step-up DC/DC converter.

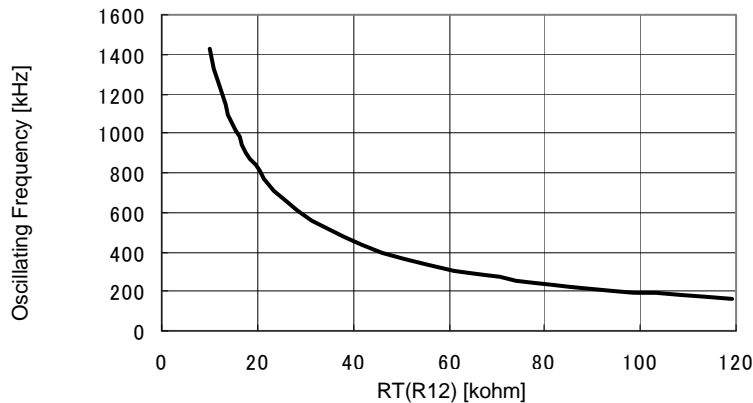

### Setting Method of the Soft-Start of Step-Up Converter

If  $V_{IN}$  is equal or more than UVLO release voltage or CE signal is "H", the soft-start of the step-up converter is operating.

External capacitor of SS pin(C9:refer to the diagram) is charged with the soft-start charge current( $I_{SS}$ ). Then the voltage of SS pin is input to the error amplifier as the reference voltage.

When the voltage of SS pin reaches to the reference voltage(Typ.1.0V) in the normal state, the reference voltage of the error amplifier becomes 1.0V. Then enters the state usually. The soft-start of step-up converter time( $t_{SS}$ ) is set by the external capacitor (C9) for the SS pin by the next formula.

$$t_{SS} = C9 \times V_{FB} / I_{SS}$$

### Setting Method for the Start-up sequence

When the output voltage of step-up converter is up to 85% of a set value, and the soft-start is finished, the external capacitors (C10 and C11) of the CPPDLY pin and the CPNDLY pin are charged by the CPPDLY charge current ( $I_{PDLY}$ ) and the CPNDLY charge current ( $I_{NDLY}$ ). When the voltage of the CPPDLY pin and the CPNDLY pin charged up to the CPPDLY detector threshold ( $V_{PDLY}$ ) and the CPNDLY detector threshold ( $V_{NDLY}$ ) then the soft-start of the positive charge-pump and the negative charge-pump are operated respectively. After the step-up converter is operated, the delay time ( $t_{PDLY}$  and  $t_{NDLY}$ ) until the soft-start of charge-pump is set by the external capacitors(C10 and C11) of the CPPDLY pin and the CPNDLY pin. That delay time is set by the following formula.

The delay time up to the operating soft-start of positive charge-pump:  $t_{PDLY} = C10 \times V_{PDLY} / I_{PDLY}$

The delay time up to the operating soft-start of negative charge-pump:  $t_{NDLY} = C11 \times V_{NDLY} / I_{NDLY}$

Thus, after the main step-up DC/DC converter is operating, the positive charge-pump and the negative charge-pump can be operating by the arbitrary order.

### The Soft-start of the Charge-pump

When the soft-start of boost charge-pump operates, the output of CPPSW changes from "H" to "L". Set the PNP-Tr1(Tr1:refer to the Typical Application) keeps  $V_{OUT2} = 0V$ , until positive charge-pump is started. If this is not required then to keep  $V_{OUT2} = 0V$ , PNP-Tr1 is unnecessary. In this case,  $V_{OUT2}$  output is approximately the  $V_{OUT1}$ . Placing the resistor(R11) between the CPPSW pin and the base of PNP-Tr1(Tr1). The maximum current of Tr1 can be set by the R11 value. This value can be calculated as in the next formula.

$$I_{max} = hFE \times (V_{OUT1} - V_{BE}) / R11 \quad [hFE \text{ is DC current gain of Tr1 and } V_{BE} \text{ is base emitter voltage of Tr1.}]$$

The efficiency will be worse if R11 is too small value. Select the appropriate value for that. (refer to the short current protection section. PNP-Tr1 has some effect on the operating of the short-current protection).

When the positive charge-pump starts, the reference voltage of the error amplifier starts from 0V and turns on to



the reference voltage (=1.5V) and become stable. Thus, the output voltage of  $V_{OUT2}$  can turn on by set output voltage within the time period of soft-start time.

When the negative charge-pump starts, the reference voltage of the error amplifier rises to  $V_{REF}$  voltage(=1.2V) before the soft-start of the negative charge-pump is operating, and falls down to 0V in the soft start time fixed internally by the soft start operation. Thus, the output voltage of  $V_{OUT3}$  can turn on by the time period of soft-start time.

### Over Current Protection

R1290 monitors the Nch-switch current of the step-up DCDC converter and limits the current. If Nch-switch current reaches the current limit, the R1290 immediately turns off Nch-switch. Nch-switch turns on every internal cycle and the R1290 monitors Nch-switch current and turns off Nch-switch if Nch-switch current reaches the current limit again. By repeating this operation, the R1290 protects itself from the over current.

### Short Current Protection / Setting Method of Timer Latch Delay Time

If any output among the step-up converter output, the positive charge-pump output or the negative charge-pump output falls, the R1290 detects the short circuit. If this short circuit condition keeps for a certain time, the latch-type protection circuit shuts down all the switching outputs ( $L_x$ , CPP, CPN) and outputs "H" through the CPPSW pin. Even if the switching stopped, the current path from CPVCC to  $V_{OUT2}$  is remained, if PNP-Tr is set on the CPPSW pin, the current path to  $V_{OUT2}$  is cut off after shutdown.

The detect voltages of  $V_{FB}$ , CPPFB and CPNFB are:

85% of predetermined  $V_{FB}$  voltage for  $V_{FB}$

85% of predetermined CPPFB voltage for CPPFB

+ 0.15V for CPNFB

The latch timer delay is set by an external capacitor (C12) of the DELAY pin. This delay time can be calculated by the next formula.

$$t_{DLY} = C12 \times V_{DLY} / I_{DLY}$$

To release latch state, make  $V_{IN}$  voltage below UVLO detector threshold and restart, or make the CE pin set at "L" and change the CE pin to "H" level.

### Setting Method of Maxduty Limit

The value of maxduty can be set by the input voltage to DTC pin. Set the voltage in which the  $V_{REF}$  output divided with the resistors R9 and R10. If the voltage of DTC pin increases more than the limit value, the lower value between the set value and the internally fixed value is selected and in valid.

### Under Voltage Lock Out (UVLO)

If  $V_{IN}$  pin voltage becomes equal or lower than UVLO detector threshold, the R1290 immediately disables all the switching outputs( $L_x$ , CPP, CPN) as well as discharges the external capacitors on DTC pin and SS pin down to 0V immediately and the system will be reset.

### TEST pin

In terms of TEST pin, connect the GND level or remain it open.

- Use a 1.0 $\mu$ F or more capacitor in between GND and  $V_{IN}$  pin, C4 as shown in the Typical Application (refer Typical Application). Connect the capacitor as close as possible to the IC. If the noise level is large, the recommendation capacitor is more than 4.7 $\mu$ F.

- Use a 1.0 $\mu$ F or more value capacitor (C1,C2 and C3) in between GND and each  $V_{OUT}$  ( $V_{OUT1}$ , $V_{OUT2}$  and  $V_{OUT3}$ ).The recommendation capacitance is  $C1=4.7\mu F\sim 22\mu F$ ,  $C2=C3=1\mu F\sim 2.2\mu F$ . (Refer to the Typical Application).
- Use a 0.1 $\mu$ F $\sim$ 1 $\mu$ F or more capacitance in between  $V_{REF}$  and GND (C6).
- To connect the GND of the capacitors (C9,C10,C11 and C12) of setting the delay time as short as possible to the GND of IC.
- Selection of the diodes and inductors and capcitors should be considered as in the note below:  
When Nch-switch turns on, there might be generated the high voltage of spike by an inductor. Thus, the voltage tolerance of connecting capacitor to  $V_{OUT}$  is more than twice of the set output voltage is the recommendation value. The diode and inductors should be selected under the value of ratings of the voltage, the current and the power(refer to the item of output current and the selection of the external components)
- Select the diode with low forward voltage such as a Schottky barrier diode. The small reverse current and the fast switching speed type is desirable. Especially, the characteristic of diode (D1) influences efficiency and the stability of the system, so make sure the note mentioned above.

**OUTPUT CURRENT AND SELECTION OF EXTERNAL COMPONENTS**



In PWM step-up switching regulator, there are two modes, the discontinuous mode and the continuous mode. These two modes depend upon the continuous characteristic of the inductor current. While PWM step-up switching regulator turn on, the voltage into the inductance L will be  $V_{IN}$  and the current can be calculated by the next formula:

$$V_{IN} \times t_{on} / L$$

In the circuit of the step-up DC/DC converter, during the off time of the switching, the electric power is supplied. In this case, the input-current can be calculated with the next formula:

$$(V_{OUT} - V_{IN}) \times T_f / L$$

In the PWM switching method, the current of inductor becomes continuous when it is  $T_f = t_{off}$ . The operating of switching regulator becomes continuous mode.

In the continuous mode, the variance of the ratio of current is equal.

$$V_{IN} \times t_{on} / L = (V_{OUT} - V_{IN}) \times t_{off} / L$$

Therefore, the DUTY in the continuous mode is calculated with the next formula:

$$DUTY = t_{on} / (t_{on} + t_{off}) = (V_{OUT} - V_{IN}) / V_{OUT}$$

Thus the input electric power and the output electric power are equal,

$$I_{OUT} = V_{IN}^2 \times t_{on} / (2 \times L \times V_{OUT})$$

If  $I_{OUT}$  value is larger than the above value, the mode becomes continuous.

In this case, the peak current ( $I_{Lxmax}$ ) of the inductor can be calculated with the next formula:

$$I_{Lxmax} = I_{OUT} \times V_{OUT} / V_{IN} + V_{IN} \times t_{on} / (2 \times L)$$

$$I_{Lxmax} = I_{OUT} \times V_{OUT} / V_{IN} + V_{IN} \times T \times (V_{OUT} - V_{IN}) / (2 \times L \times V_{OUT})$$

In this way, the value of the peak current becomes larger value than the  $I_{OUT}$  value. Note that the I/O condition and  $I_{Lxmax}$ , to select parts around the I/O.

The explanation of above-mentioned are based on the calculations of the ideal case, the external components, or the loss of  $L_x$  switching, are not included. The actual maximum output current is 50~80% of the above-mentioned.

Especially, in case that the  $I_L$  is large, or  $V_{IN}$  is low, the loss of  $V_{IN}$  will be the amount of the ON resistance of the switch. Also, the consideration of the loss (approximately 0.3V) of  $V_{OUT}$  by the value of  $V_F$  of the diode is necessary.

## TIMING CHART

### • Overall Sequence

The timing chart below describes from the power on to the  $V_{OUT1}$ ,  $V_{OUT2}$ ,  $V_{OUT3}$  turn on and until they are stable. By release the standby mode,  $V_{OUT1}$  begins the soft-start, then, the output voltage rises gradually.

After preset soft-start time passes, when the  $V_{OUT1}$  reaches the preset output voltage, charge to capacitors set to CPPDLY pin and CPNDLY pin will start. CPPDLY pin and CPNDLY pin voltage reach respectively to the CPPDLY detector threshold ( $V_{PDLY}$ ), CPNDLY detector threshold ( $V_{NDLY}$ ), then the soft-start of charge pump will begin. The delay time for soft-start of charge pump ( $t_{PDLY}$ ,  $t_{NDLY}$ ) can be set respectively.

Each delay time has passed, the soft-start of the charge pump will begin,  $V_{OUT2}$ ,  $V_{OUT3}$  will be the preset output voltages.



### • $V_{OUT1}$ Soft Start Operation

The time chart below is from the CE signal turns on until the soft-start of  $V_{OUT1}$  will finish.

#### (STEP1)

SS level has increased with the internal IC's constant current and an external capacitor, the level of SS is gradually rising. During the soft-start time, the amplifier's reference input to the OP AMP becomes equal level as SS, and rising gradually.

$V_{OUT}$  reaches to the input voltage just after the power on, VFB voltage will rise the specific voltage determined by the input voltage and the feedback part resistance ratio, then AMPOUT will be "L" and the switching will not begin.

#### (STEP2)

When the SS becomes the specified voltage determined with the input voltage and the feedback part ratio, the switching will start. In this case, the amplifier reference will rise as well as SS, therefore, to balance the amplifier reference and VFB,  $V_{OUT}$  will be rising. In this case, the DUTY is determined by the three inputs PWM comparator, among the AMPOUT and DTC, the lowest voltage will be selected.

#### (STEP3)

When the SS becomes 1V, then soft-start will finish and the amplifier reference will be the constant voltage(=1V), then normal switching operation will start. Then, the level of the AMPOUT is normal and determined by the input and output voltage, and output current.

During the soft-start time, charge to DELAY pin requires soft-starting time. The soft-start time must set the timer latch delay time shorter, and when the preset soft-start time finishes, Charge to the DELAY pin will stop and discharge to the GND.



**TYPICAL CHARACTERISTICS**

**1) Vout1(DCDC)**

**1-1) Output Voltage VS. Output Current**



**R1290K102A**

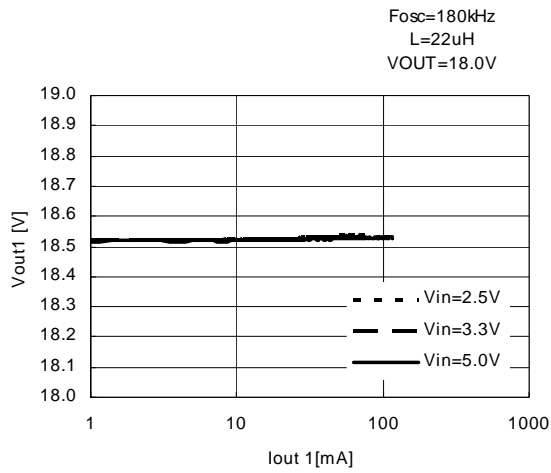

**R1290K102A**

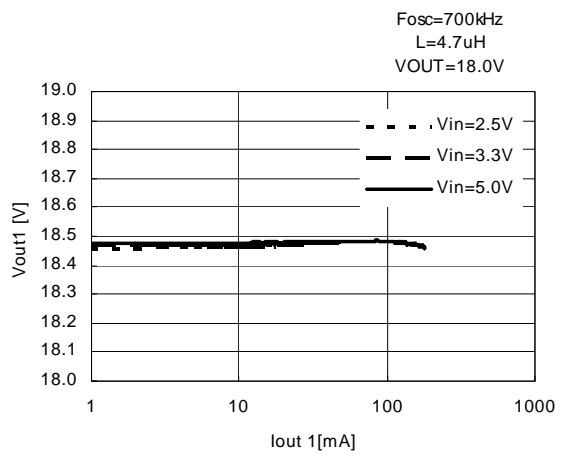

**R1290K102A**

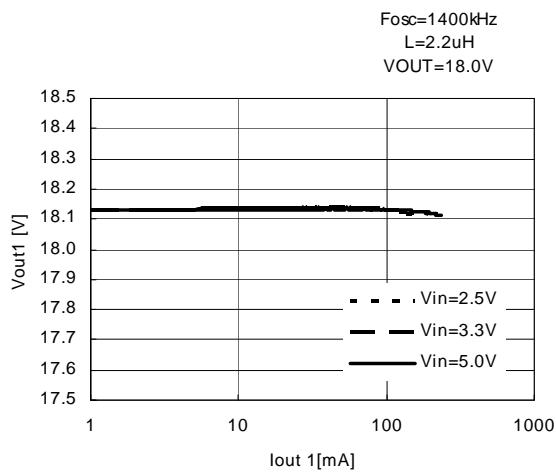

**1-2) Efficiency VS. Output Current**

**R1290K102A**

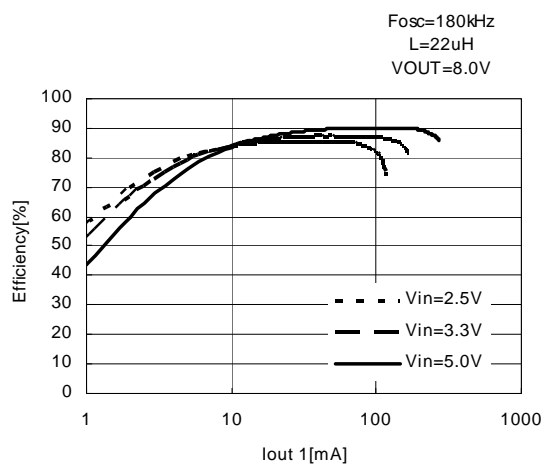

**R1290K102A**

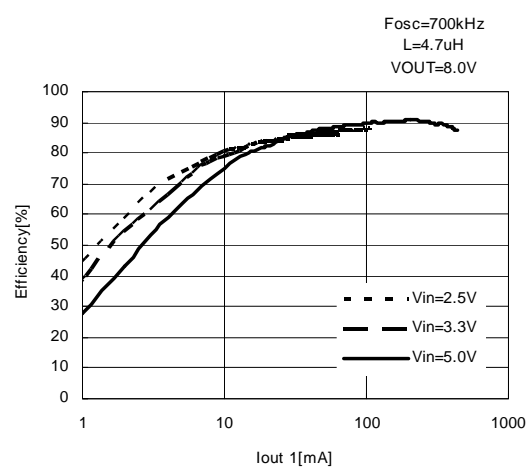







**2) Vout2(Step-Up Charge-pump part)**  
**2-1) Output Voltage VS. Output Current**

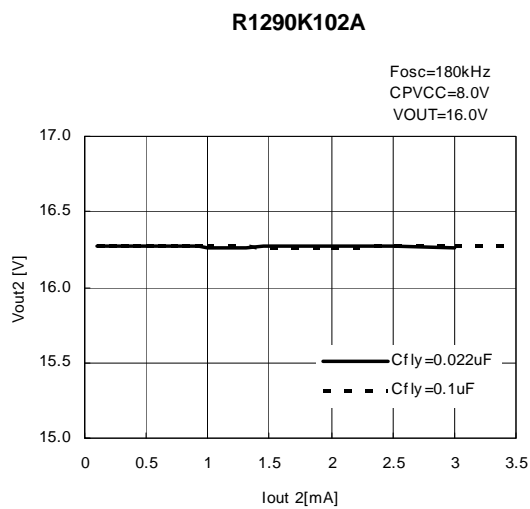
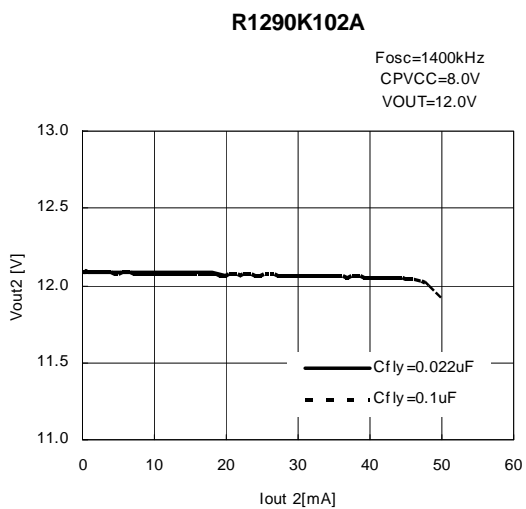

# R1290x

**R1290K102A**

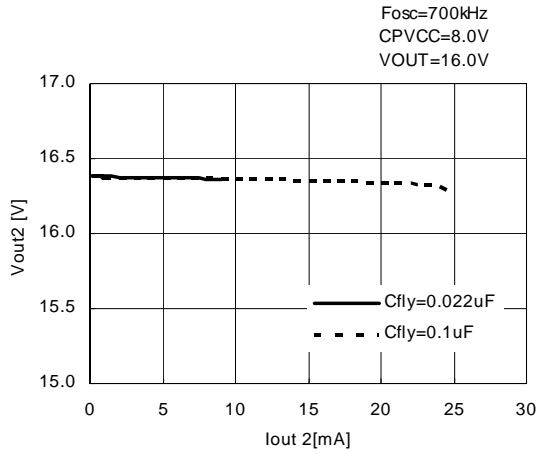

**R1290K102A**

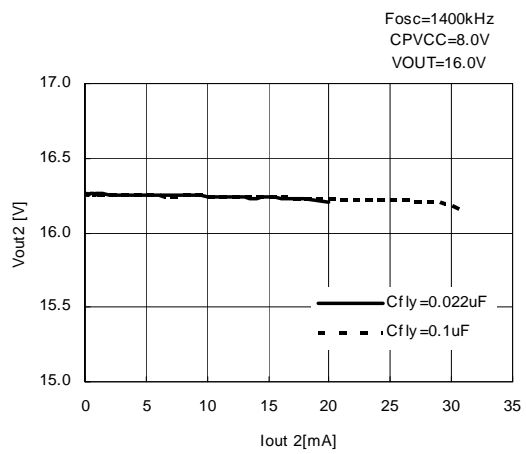

**R1290K102A**

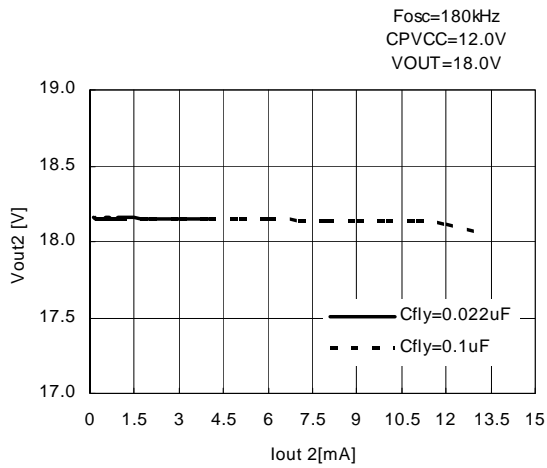

**R1290K102A**

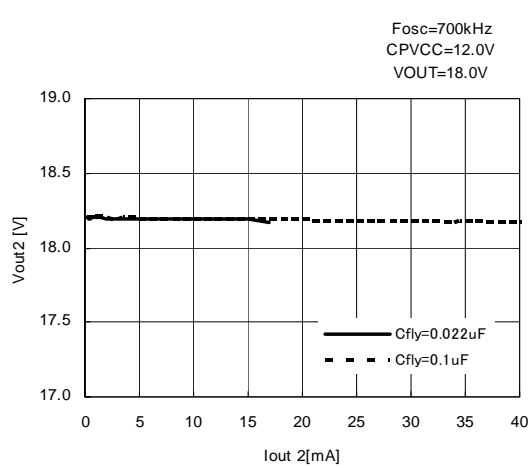

**R1290K102A**

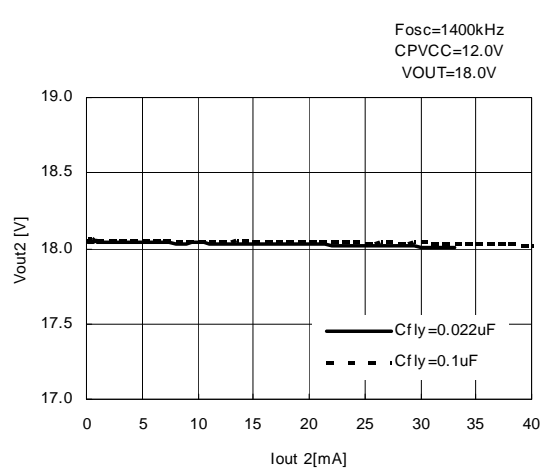

**R1290K102A**

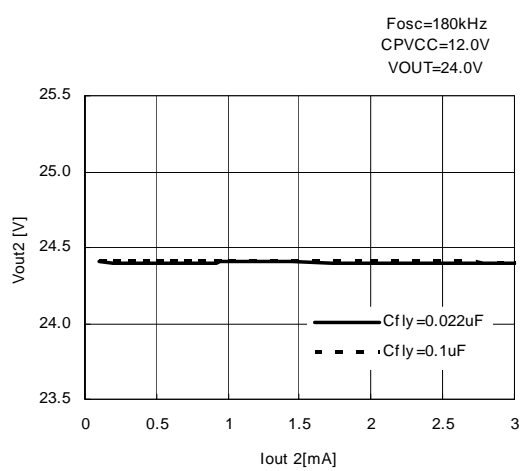

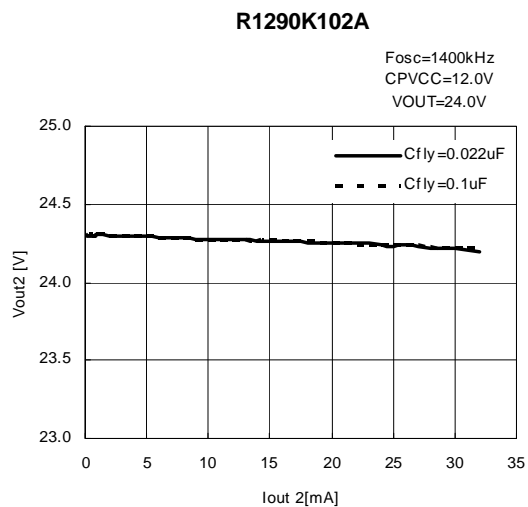

**3) Vout3(Invert Charge-pump part)**  
**3-1) Output Voltage VS. Output Current**

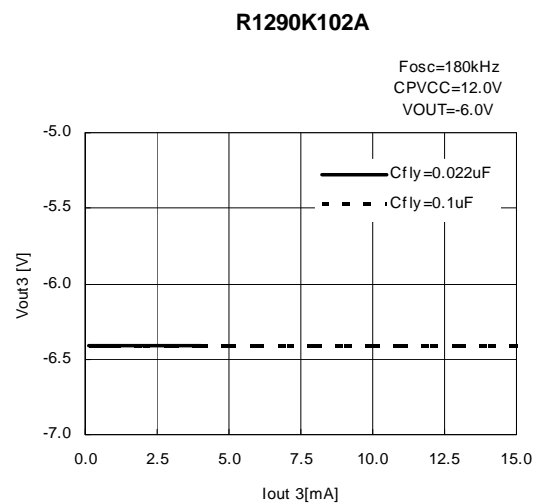
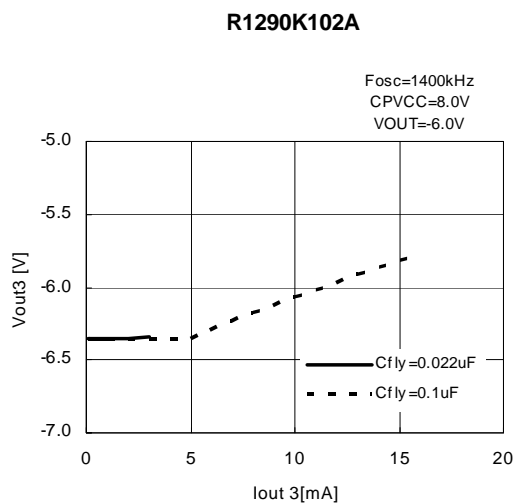
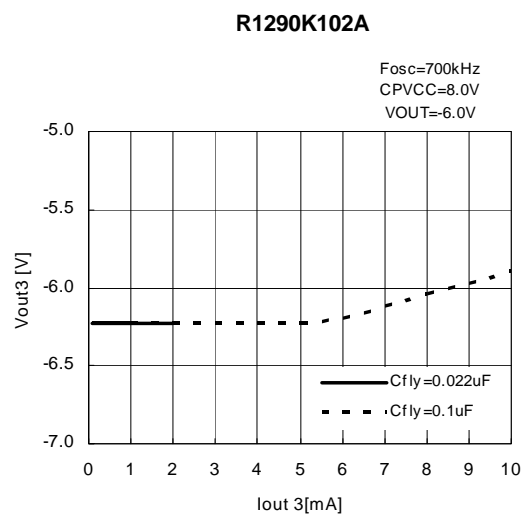
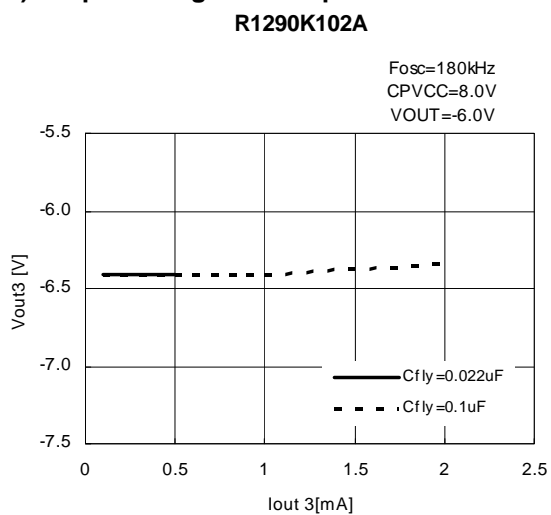

R1290K102A



R1290K102A



4) VFB Voltage VS. Input Voltage  
R1290K102A

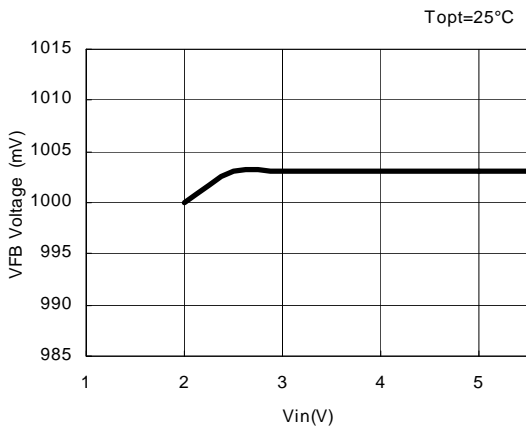

5) Osillator Frequency VS. Input Voltage  
R1290K102A



R1290K102A



R1290K102A



6) Supply Current VS. Input Voltage

R1290K102A



R1290K102A



7) Maxduty VS. Input Voltage

R1290K102A



8) VIN Supply Current VS. Temperature

R1290K102A



9) CP Supply Current VS. Temperature

R1290K102A



10) UVLO Detect Voltage VS. Temperature

R1290K102A



R1290K102A



11) UVLO Release Voltage VS. Temperature

R1290K102A

R1290K102A



R1290K102A

R1290K102A



**12) VFB Voltage VS. Temperature**  
R1290K102A



**13) Maxduty VS. Temperature**  
R1290K102A

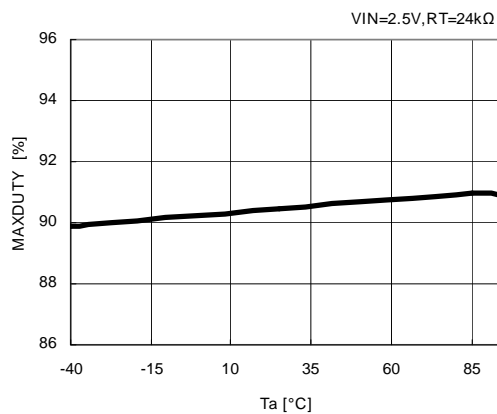

**14) AMP"H" Output Current VS. Temperature**  
R1290K102A



**15) AMP"L" Output Current VS. Temperature**  
R1290K102A

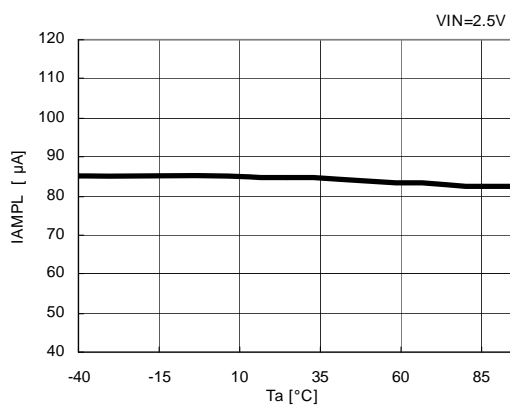

**16) Switch ON Resistance VS. Temperature**  
R1290K102A



**17) Switch Leakage Current VS. Temperature**  
R1290K102A

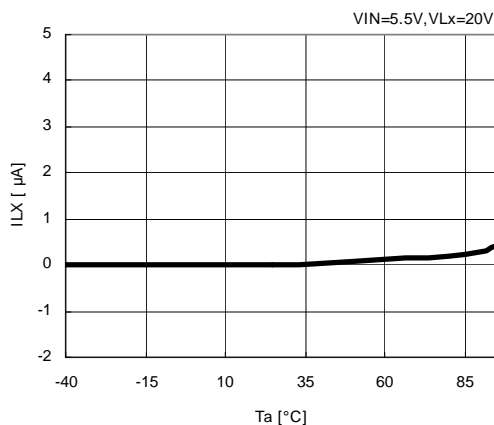

18) Switch Limit Current VS. temperature  
R1290K102A



R1290K102A

19) Oscillator Frequency VS. Temperature  
R1290K102A



R1290K102A



20) VREF Voltage VS. Temperature  
R1290K102A



21) Terminal SS charge current VS. Temperature  
R1290K102A

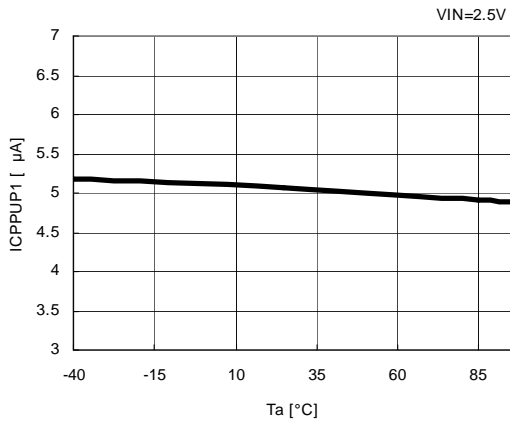



22) CPP Soft-Start VS. Temperature  
R1290K102A



23) CPN Soft-Start VS. Temperature.  
R1290K102A



24) CPPDLY Charge Current VS. Temperature.  
R1290K102A



25) CPNDLY Charge Current VS. Temperature  
R1290K102A

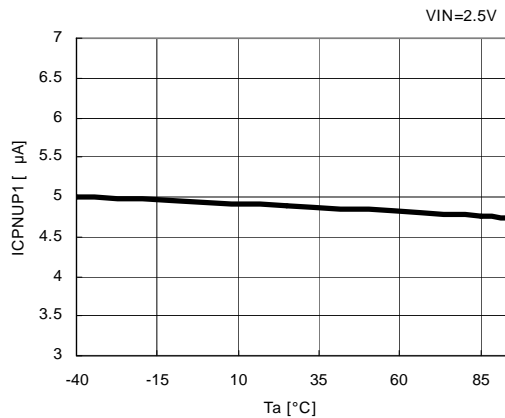

26) CPPDLY Detector Threshold VS. Temperature  
R1290K102A

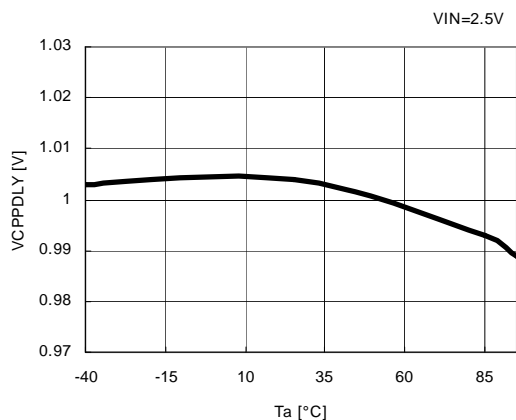

27) CPNDLY Detector Threshold VS. Temperature  
R1290K102A

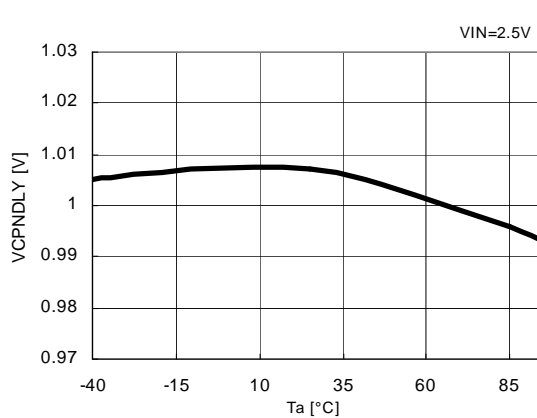

28) CPPFB Voltage VS. Temperature  
R1290K102A



29) CPNFB Voltage VS. Temperature  
R1290K102A



30) CPP"H"ON Resistance VS. Temperature  
R1290K102A



31) CPP"L"ON Resistance VS. Temperature  
R1290K102A



32) CPN"H"ON Resistance VS. Temperature  
R1290K102A



33) CPN"L"ON Resistance VS. Temperature  
R1290K102A



**34) Charge-pump Frequency VS. Temperature**  
R1290K102A



**R1290K102A**



**35) DELAY Charge Current VS. Temperature**  
R1290K102A



**36) DELAY Discharge Current VS. Temperature**  
R1290K102A



**37) DELAY Detector Threshold VS. Temperature**  
R1290K102A



**38) CPPSW "L" Output Voltage VS. Temperature**  
R1290K102A

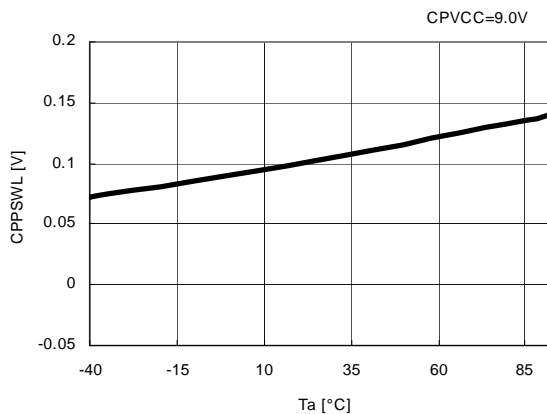

**39) Standby Current VS. Temperature**  
R1290K102A

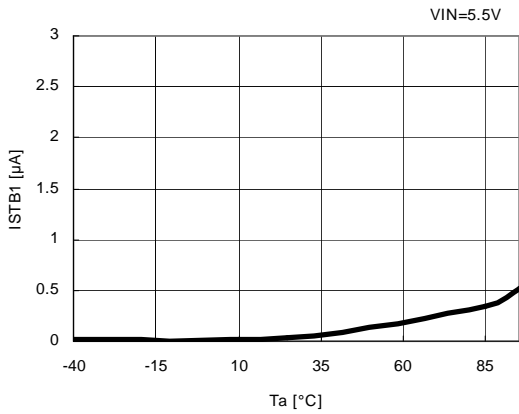

**R1290K102A**

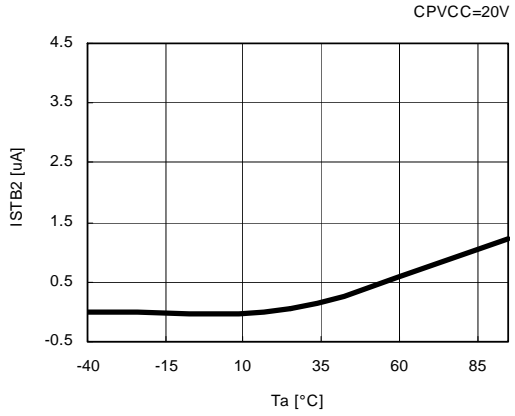

**40) CE "L" Input Current VS. Temperature**  
R1290K102A



**41) CE "H" Input Current VS. Temperature**  
R1290K102A



42) Road Transient Response  
R1290K102A



R1290K102A



R1290K102A



R1290K102A

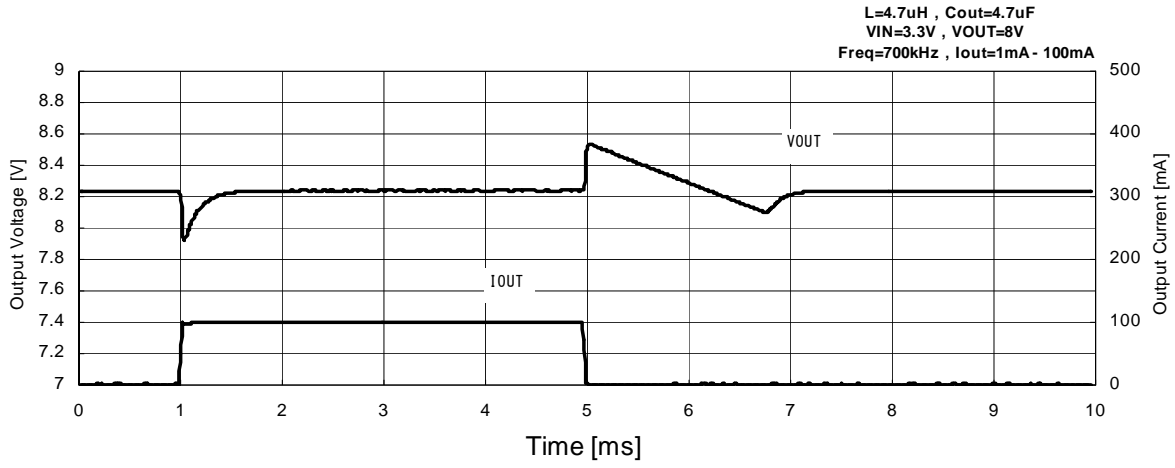

R1290K102A



R1290K102A

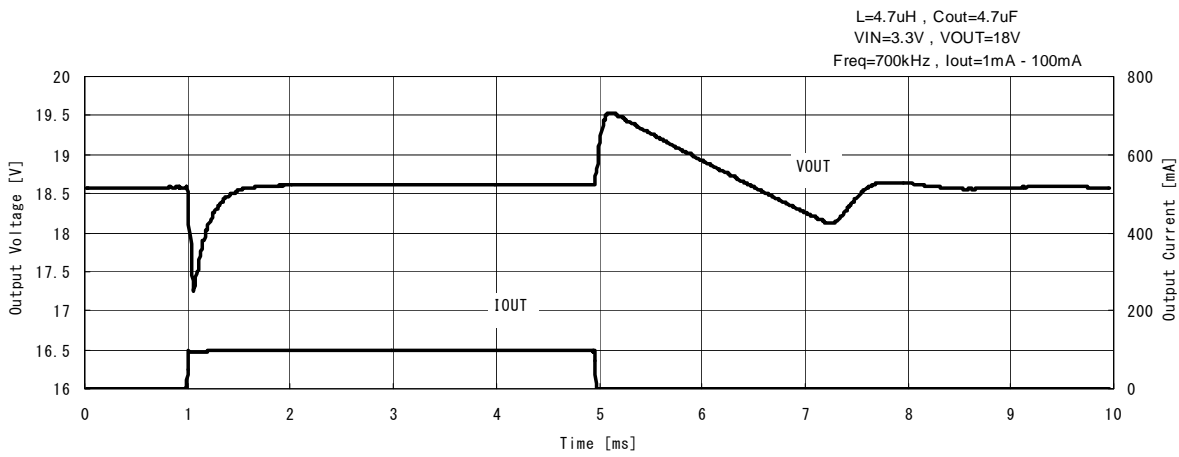

R1290K102A



R1290K102A



R1290K102A



43) CE Switch Response

R1290K102A



R1290K102A



R1290K102A







1. The products and the product specifications described in this document are subject to change or discontinuation of production without notice for reasons such as improvement. Therefore, before deciding to use the products, please refer to Ricoh sales representatives for the latest information thereon.
2. The materials in this document may not be copied or otherwise reproduced in whole or in part without prior written consent of Ricoh.
3. Please be sure to take any necessary formalities under relevant laws or regulations before exporting or otherwise taking out of your country the products or the technical information described herein.
4. The technical information described in this document shows typical characteristics of and example application circuits for the products. The release of such information is not to be construed as a warranty of or a grant of license under Ricoh's or any third party's intellectual property rights or any other rights.
5. The products listed in this document are intended and designed for use as general electronic components in standard applications (office equipment, telecommunication equipment, measuring instruments, consumer electronic products, amusement equipment etc.). Those customers intending to use a product in an application requiring extreme quality and reliability, for example, in a highly specific application where the failure or misoperation of the product could result in human injury or death (aircraft, spacevehicle, nuclear reactor control system, traffic control system, automotive and transportation equipment, combustion equipment, safety devices, life support system etc.) should first contact us.
6. We are making our continuous effort to improve the quality and reliability of our products, but semiconductor products are likely to fail with certain probability. In order to prevent any injury to persons or damages to property resulting from such failure, customers should be careful enough to incorporate safety measures in their design, such as redundancy feature, fire containment feature and fail-safe feature. We do not assume any liability or responsibility for any loss or damage arising from misuse or inappropriate use of the products.
7. Anti-radiation design is not implemented in the products described in this document.
8. The X-ray exposure can influence functions and characteristics of the products. Confirm the product functions and characteristics in the evaluation stage.
9. WLCSP products should be used in light shielded environments. The light exposure can influence functions and characteristics of the products under operation or storage.
10. There can be variation in the marking when different AOI (Automated Optical Inspection) equipment is used. In the case of recognizing the marking characteristic with AOI, please contact Ricoh sales or our distributor before attempting to use AOI.
11. Please contact Ricoh sales representatives should you have any questions or comments concerning the products or the technical information.



**Ricoh is committed to reducing the environmental loading materials in electrical devices with a view to contributing to the protection of human health and the environment.**

Ricoh has been providing RoHS compliant products since April 1, 2006 and Halogen-free products since April 1, 2012.

**RICOH** RICOH ELECTRONIC DEVICES CO., LTD.

<https://www.e-devices.ricoh.co.jp/en/>

#### Sales & Support Offices

##### **Ricoh Electronic Devices Co., Ltd.**

##### **Shin-Yokohama Office (International Sales)**

2-3, Shin-Yokohama 3-chome, Kohoku-ku, Yokohama-shi, Kanagawa, 222-8530, Japan  
Phone: +81-50-3814-7687 Fax: +81-45-474-0074

##### **Ricoh Americas Holdings, Inc.**

675 Campbell Technology Parkway, Suite 200 Campbell, CA 95008, U.S.A.  
Phone: +1-408-610-3105

##### **Ricoh Europe (Netherlands) B.V.**

##### **Semiconductor Support Centre**

Prof. W.H. Keesomlaan 1, 1183 DJ Amstelveen, The Netherlands  
Phone: +31-20-5474-309

##### **Ricoh International B.V. - German Branch**

##### **Semiconductor Sales and Support Centre**

Oberrather Strasse 6, 40472 Düsseldorf, Germany  
Phone: +49-211-6546-0

##### **Ricoh Electronic Devices Korea Co., Ltd.**

3F, Haesung Bldg, 504, Teheran-ro, Gangnam-gu, Seoul, 135-725, Korea  
Phone: +82-2-2135-5700 Fax: +82-2-2051-5713

##### **Ricoh Electronic Devices Shanghai Co., Ltd.**

Room 403, No.2 Building, No.690 Bibo Road, Pu Dong New District, Shanghai 201203,  
People's Republic of China  
Phone: +86-21-5027-3200 Fax: +86-21-5027-3299

##### **Ricoh Electronic Devices Shanghai Co., Ltd.**

##### **Shenzhen Branch**

1205, Block D (Jinlong Building), Kingkey 100, Hongbao Road, Luohu District,  
Shenzhen, China  
Phone: +86-755-8348-7600 Ext 225

##### **Ricoh Electronic Devices Co., Ltd.**

##### **Taipei office**

Room 109, 10F-1, No.51, Hengyang Rd., Taipei City, Taiwan (R.O.C.)  
Phone: +886-2-2313-1621/1622 Fax: +886-2-2313-1623

# Mouser Electronics

Authorized Distributor

Click to View Pricing, Inventory, Delivery & Lifecycle Information:

[Ricoch Electronics:](#)

[R1290K102A-E2](#) [R1290K103A-E2](#) [R1290K001A-E2](#) [R1290K002A-E2](#) [R1290K003A-E2](#) [R1290K101A-E2](#)



## Стандарт Электрон Связь

Мы молодая и активно развивающаяся компания в области поставок электронных компонентов. Мы поставляем электронные компоненты отечественного и импортного производства напрямую от производителей и с крупнейших складов мира.

Благодаря сотрудничеству с мировыми поставщиками мы осуществляем комплексные и плановые поставки широчайшего спектра электронных компонентов.

Собственная эффективная логистика и склад в обеспечивает надежную поставку продукции в точно указанные сроки по всей России.

Мы осуществляем техническую поддержку нашим клиентам и предпродажную проверку качества продукции. На все поставляемые продукты мы предоставляем гарантию .

Осуществляем поставки продукции под контролем ВП МО РФ на предприятия военно-промышленного комплекса России , а также работаем в рамках 275 ФЗ с открытием отдельных счетов в уполномоченном банке. Система менеджмента качества компании соответствует требованиям ГОСТ ISO 9001.

Минимальные сроки поставки, гибкие цены, неограниченный ассортимент и индивидуальный подход к клиентам являются основой для выстраивания долгосрочного и эффективного сотрудничества с предприятиями радиоэлектронной промышленности, предприятиями ВПК и научно-исследовательскими институтами России.

С нами вы становитесь еще успешнее!

### Наши контакты:

**Телефон:** +7 812 627 14 35

**Электронная почта:** [sales@st-electron.ru](mailto:sales@st-electron.ru)

**Адрес:** 198099, Санкт-Петербург,  
Промышленная ул, дом № 19, литера Н,  
помещение 100-Н Офис 331