

# BSP75G

## 60V self-protected low-side IntelliFET™ MOSFET switch

### Summary

<b>Continuous drain source voltage</b>	<b><math>V_{DS}=60V</math></b>
<b>On-state resistance</b>	<b>550mΩ</b>
<b>Nominal load current</b>	<b>1.4A (<math>V_{IN} = 5V</math>)</b>
<b>Clamping energy</b>	<b>550mJ</b>

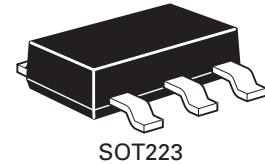

### Description

Self-protected low side MOSFET. Monolithic over temperature, over current, over voltage (active clamp) and ESD protected logic level power MOSFET intended as a general purpose switch.

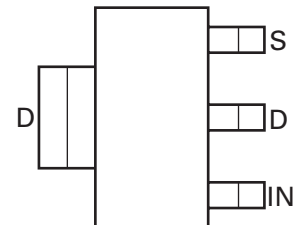

### Features

- Short circuit protection with auto restart
- Over-voltage protection (active clamp)
- Thermal shutdown with auto restart
- Over-current protection
- Input protection (ESD)
- High continuous current rating
- Load dump protection (actively protects load)
- Logic level input

### Note:

The tab is connected to the drain pin, and must be electrically isolated from the source pin. Connection of significant copper to the tab is recommended for best thermal performance.

### Ordering information

Device	Reel size (inches)	Tape width (mm)	Quantity per reel
BSP75GTA	7	12mm embossed	1,000
BSP75GTC	13	12mm embossed	4,000

### Device marking

BSP75G

## Functional block diagram

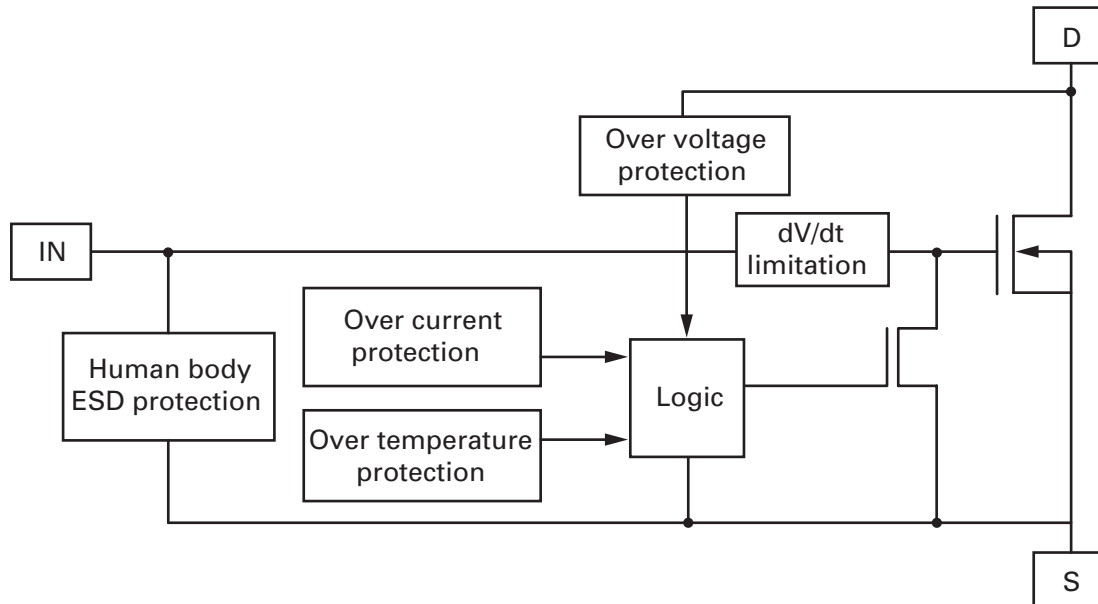

## Applications

- Especially suited for loads with a high in-rush current such as lamps and motors.
- All types of resistive, inductive and capacitive loads in switching applications.
- $\mu\text{C}$  compatible power switch for 12V and 24V DC applications.
- Automotive rated.
- Replaces electromechanical relays and discrete circuits.
- Linear mode capability - the current-limiting protection circuitry is designed to de-activate at low  $V_{ds}$ , in order not to compromise the load current during normal operation. The design maximum DC operating current is therefore determined by the thermal capability of the package/board combination, rather than by the protection circuitry.

## Absolute maximum ratings

Parameter	Symbol	Limit	Unit
Continuous drain-source voltage	$V_{DS}$	60	V
Drain-source voltage for short circuit protection	$V_{DS(SC)}$	36	V
Continuous input voltage	$V_{IN}$	-0.2 ... +10	V
Peak input voltage	$V_{IN}$	-0.2 ... +20	V
Operating temperature range	$T_{j,r}$	-40 to +150	°C
Storage temperature range	$T_{stg}$	-55 to +150	°C
Power dissipation at $T_A = 25^\circ\text{C}^{(a)}$	$P_D$	2.5	W
Continuous drain current @ $V_{IN}=10\text{V}; T_A=25^\circ\text{C}^{(a)}$	$I_D$	1.6	A
Continuous drain current @ $V_{IN}=5\text{V}; T_A=25^\circ\text{C}^{(a)}$	$I_D$	1.4	A
Pulsed drain current @ $V_{IN}=10\text{V}$	$I_{DM}$	5	A
Continuous source current (body diode) <sup>(a)</sup>	$I_S$	3	A
Pulsed source current (body diode)	$I_S$	5	A
Unclamped single pulse inductive energy	$E_{AS}$	550	mJ
Load dump protection	$V_{LoadDump}$	80	V
Electrostatic discharge (human body model)	$V_{ESD}$	4000	V
DIN humidity category, DIN 40 040		E	
IEC climatic category, DIN IEC 68-1		40/150/56	

## Thermal resistance

Parameter	Symbol	Limit	Unit
Junction to ambient <sup>(a)</sup>	$R_{\theta JA}$	50	°C/W
Junction to ambient <sup>(b)</sup>	$R_{\theta JA}$	24	°C/W
Junction to ambient <sup>(c)</sup>	$R_{\theta JA}$	208	°C/W

### NOTES:

(a) For a device surface mounted on 37mm x 37mm x 1.6mm FR4 board with a high coverage of single sided 2oz weight copper.

(b) For a device surface mounted on FR4 board and measured at  $t \leq 10\text{s}$ .

(c) For a device mounted on FR4 board with the minimum copper required for electrical connections.

## Characteristics

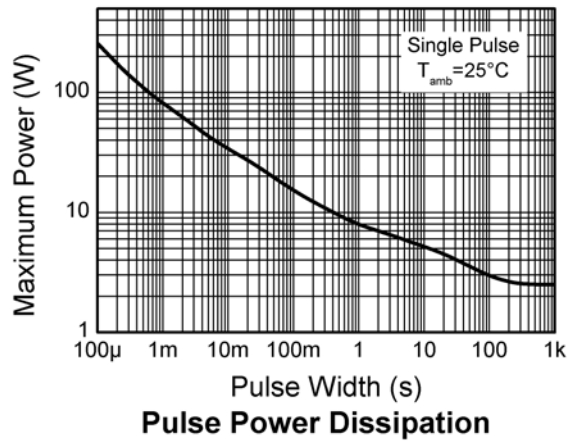
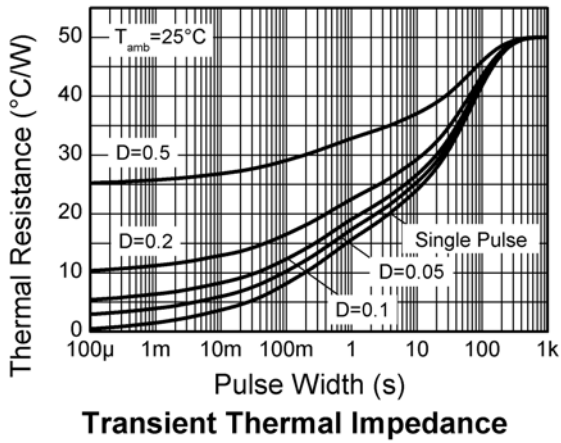
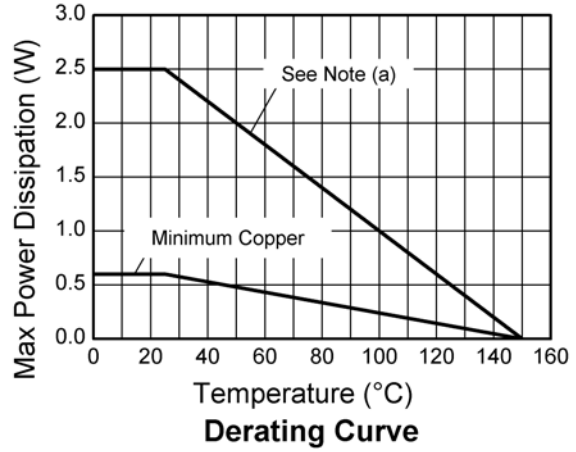
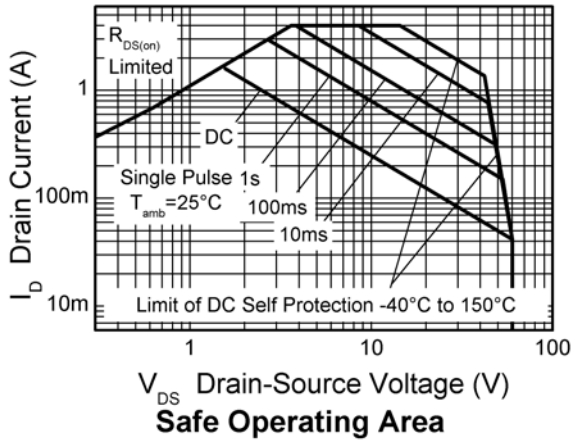

## Electrical characteristics (at Tamb = 25°C unless otherwise stated)

Parameter	Symbol	Min.	Typ.	Max.	Unit	Conditions
<b>Static characteristics</b>						
Drain-source clamp voltage	$V_{DS(AZ)}$	60	70	75	V	$I_D=10mA$
Off-state drain current	$I_{DSS}$		0.1	3	$\mu A$	$V_{DS}=12V, V_{IN}=0V$
Off-state drain current	$I_{DSS}$		3	15	$\mu A$	$V_{DS}=32V, V_{IN}=0V$
Input threshold voltage (*)	$V_{IN(th)}$	1	2.1		V	$V_{DS}=V_{GS}, I_D=1mA$
Input current	$I_{IN}$		0.7	1.2	mA	$V_{IN}=+5V$
Input current	$I_{IN}$		1.5	2.7	mA	$V_{IN}=+7V$
Input current	$I_{IN}$		4	7	mA	$V_{IN}=+10V$
Static drain-source on-state resistance	$R_{DS(on)}$		520	675	m $\Omega$	$V_{IN}=+5V, I_D=0.7A$
Static drain-source on-state resistance	$R_{DS(on)}$		385	550	m $\Omega$	$V_{IN}=+10V, I_D=0.7A$
Current limit (†)	$I_{D(LIM)}$	0.7	1.1	1.75	A	$V_{IN}=+5V, V_{DS}>5V$
Current limit (†)	$I_{D(LIM)}$	2	3	4	A	$V_{IN}=+10V, V_{DS}>5V$
<b>Dynamic characteristics</b>						
Turn-on time ( $V_{IN}$ to 90% $I_D$ )	$t_{on}$		2.2	10	$\mu s$	$R_L=22\Omega, V_{DD}=12V, V_{IN}=0$ to $+10V$
Turn-off time ( $V_{IN}$ to 90% $I_D$ )	$t_{off}$		13	20	$\mu s$	$R_L=22\Omega, V_{DD}=12V, V_{IN}=+10V$ to $0V$
Slew rate on (70 to 50% $V_{DD}$ )	$-dV_{DS}/dt_{on}$		10	20	V/ $\mu s$	$R_L=22\Omega, V_{DD}=12V, V_{IN}=0$ to $+10V$
Slew rate off (50 to 70% $V_{DD}$ )	$dV_{DS}/dt_{off}$		3.2	10	V/ $\mu s$	$R_L=22\Omega, V_{DD}=12V, V_{IN}=+10V$ to $0V$
<b>Protection functions (‡)</b>						
Required input voltage for over temperature protection	$V_{PROT}$	4.5			V	
Thermal overload trip temperature	$T_{JT}$	150	175		$^{\circ}C$	
Thermal hysteresis			10		$^{\circ}C$	
Unclamped single pulse inductive energy $T_j=25^{\circ}C$	$E_{AS}$	550			mJ	$I_{D(ISO)}=0.7A, V_{DD}=32V$
Unclamped single pulse inductive energy $T_j=150^{\circ}C$	$E_{AS}$	200			mJ	$I_{D(ISO)}=0.7A, V_{DD}=32V$
<b>Inverse diode</b>						
Source drain voltage	$V_{SD}$				1	$V_{IN}=0V, -I_D=1.4A$

### NOTES:

(\*) Protection features may operate outside spec for  $V_{IN}<4.5V$ .

(†) The drain current is limited to a reduced value when  $V_{DS}$  exceeds a safe level.

(‡) Integrated protection functions are designed to prevent IC destruction under fault conditions described in the datasheet. Fault conditions are considered as "outside" normal operating range. Protection functions are not designed for continuous, repetitive operation.

## Characteristics

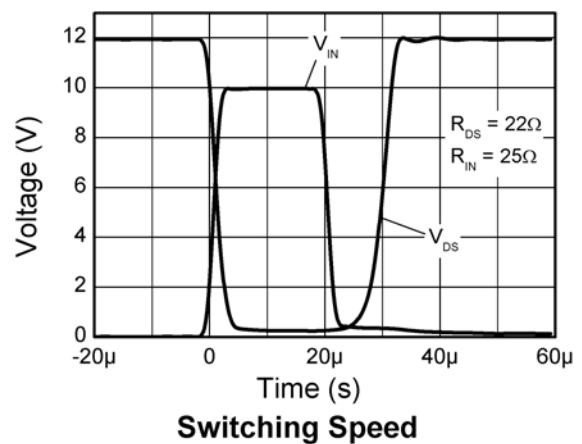
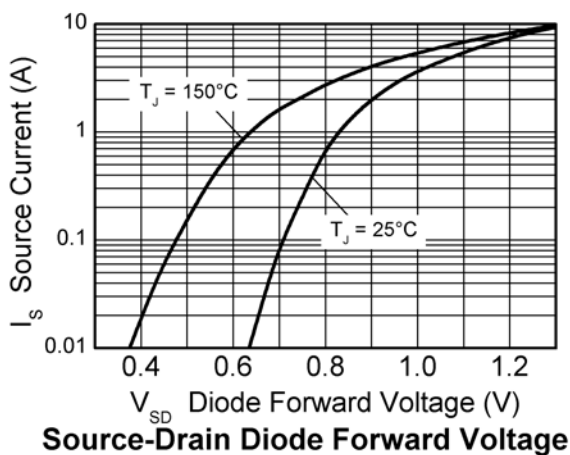
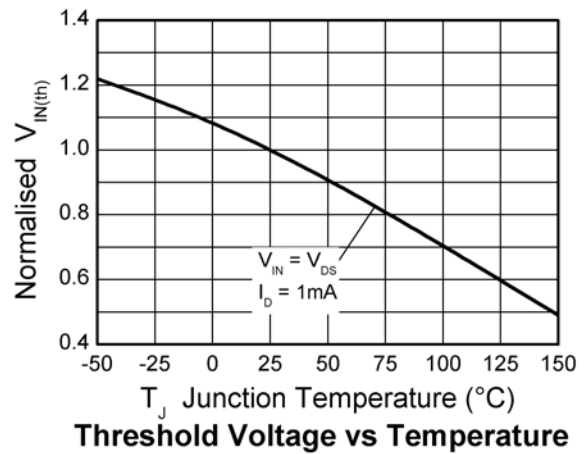
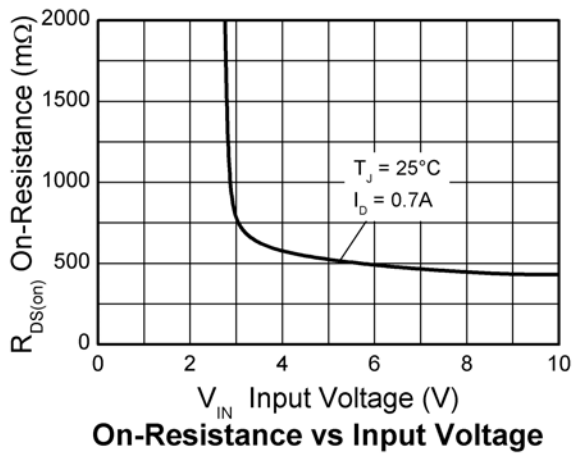
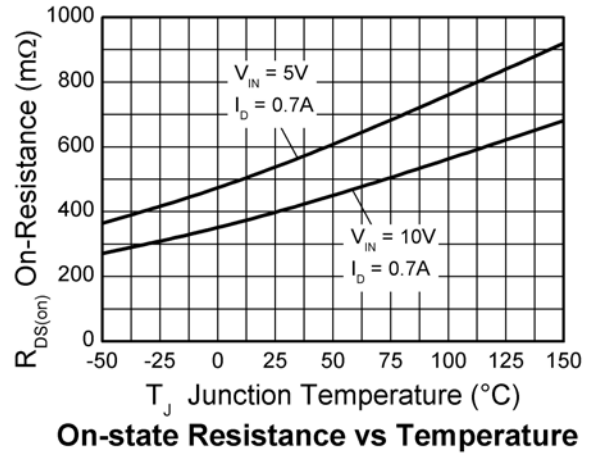
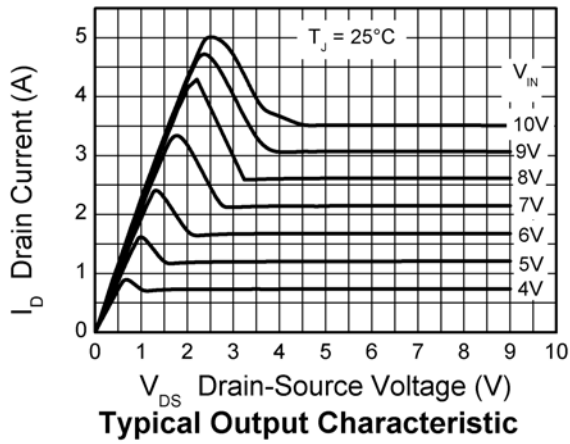

Intentionally left blank

## Package outline - SOT223

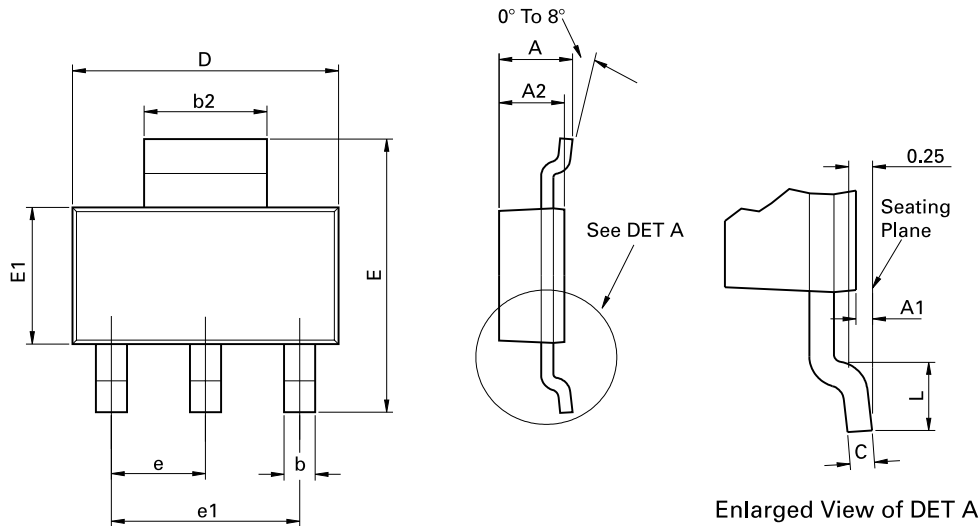

Conforms to JEDEC TO-261 AA Issue B

Dim.	Millimeters		Inches		Dim.	Millimeters		Inches	
	Min.	Max.	Min.	Max.		Min.	Max.	Min.	Max.
A	-	1.80	-	0.071	e	2.30 BSC		0.0905 BSC	
A1	0.02	0.10	0.0008	0.004	e1	4.60 BSC		0.181 BSC	
b	0.66	0.84	0.026	0.033	E	6.70	7.30	0.264	0.287
b2	2.90	3.10	0.114	0.122	E1	3.30	3.70	0.130	0.146
C	0.23	0.33	0.009	0.013	L	0.90	-	0.355	-
D	6.30	6.70	0.248	0.264	-	-	-	-	-

**Note:** Controlling dimensions are in millimeters. Approximate dimensions are provided in inches

Europe	Americas	Asia Pacific	Corporate Headquarters
Zetex GmbH Streitfeldstraße 19 D-81673 München Germany	Zetex Inc 700 Veterans Memorial Highway Hauppauge, NY 11788 USA	Zetex (Asia Ltd) 3701-04 Metroplaza Tower 1 Hing Fong Road, Kwai Fong Hong Kong	Zetex Semiconductors plc Zetex Technology Park, Chadderton Oldham, OL9 9LL United Kingdom
Telefon: (49) 89 45 49 49 0 Fax: (49) 89 45 49 49 49 europe.sales@zetex.com	Telephone: (1) 631 360 2222 Fax: (1) 631 360 8222 usa.sales@zetex.com	Telephone: (852) 26100 611 Fax: (852) 24250 494 asia.sales@zetex.com	Telephone: (44) 161 622 4444 Fax: (44) 161 622 4446 hq@zetex.com

These offices are supported by agents and distributors in major countries world-wide.

This publication is issued to provide outline information only which (unless agreed by the company in writing) may not be used, applied or reproduced for any purpose or form part of any order or contact or be regarded as a representation relating to the products or services concerned. The company reserves the right to alter without notice the specification, design, price or conditions of supply of any product or service.





## Стандарт Электрон Связь

Мы молодая и активно развивающаяся компания в области поставок электронных компонентов. Мы поставляем электронные компоненты отечественного и импортного производства напрямую от производителей и с крупнейших складов мира.

Благодаря сотрудничеству с мировыми поставщиками мы осуществляем комплексные и плановые поставки широчайшего спектра электронных компонентов.

Собственная эффективная логистика и склад в обеспечивает надежную поставку продукции в точно указанные сроки по всей России.

Мы осуществляем техническую поддержку нашим клиентам и предпродажную проверку качества продукции. На все поставляемые продукты мы предоставляем гарантию .

Осуществляем поставки продукции под контролем ВП МО РФ на предприятия военно-промышленного комплекса России , а также работаем в рамках 275 ФЗ с открытием отдельных счетов в уполномоченном банке. Система менеджмента качества компании соответствует требованиям ГОСТ ISO 9001.

Минимальные сроки поставки, гибкие цены, неограниченный ассортимент и индивидуальный подход к клиентам являются основой для выстраивания долгосрочного и эффективного сотрудничества с предприятиями радиоэлектронной промышленности, предприятиями ВПК и научно-исследовательскими институтами России.

С нами вы становитесь еще успешнее!

### Наши контакты:

**Телефон:** +7 812 627 14 35

**Электронная почта:** [sales@st-electron.ru](mailto:sales@st-electron.ru)

**Адрес:** 198099, Санкт-Петербург,  
Промышленная ул, дом № 19, литера Н,  
помещение 100-Н Офис 331