

Features

- Fast Switching Speed
- Surface Mount Package Ideally Suited for Automated Insertion
- For General Purpose Switching Applications
- High Conductance
- **Lead, Halogen and Antimony Free, RoHS Compliant**
- **"Green" Device (Notes 1 and 2)**

Mechanical Data

- Case: SOT-23
- Case Material: Molded Plastic. UL Flammability Classification Rating 94V-0
- Moisture Sensitivity: Level 1 per J-STD-020
- Terminals: Matte Tin Finish annealed over Alloy 42 leadframe (Lead Free Plating). Solderable per MIL-STD-202, Method 208
- Polarity: See Diagram
- Weight: 0.008 grams (approximate)



Ordering Information (Note 3)

Part Number	Case	Packaging
MMBD4448-7-F	SOT-23	3000/Tape & Reel

- Notes:
1. No purposefully added lead. Halogen and Antimony Free.
 2. Product manufactured with Date Code V9(week 34, 2008) and newer are built with Green Molding Compound. Product manufactured prior to Date Code V9 are built with Non-Green Molding Compound and may contain Halogens or Sb2O3 Fire Retardants.
 3. For packaging details, go to our website at <http://www.diodes.com>.

Marking Information

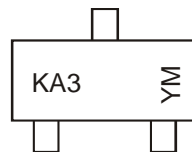

KA3 = Product Type Marking Code
 YM = Date Code Marking
 Y = Year (ex: N = 2002)
 M = Month (ex: 9 = September)

Date Code Key

Year	1999	2000	2001	2002	2003	2004	2005	2006	2007	2008	2009	2010	2011	2012	2013	2014	2015
Code	K	L	M	N	P	R	S	T	U	V	W	X	Y	Z	A	B	C
Month	Jan	Feb	Mar	Apr	May	Jun	Jul	Aug	Sep	Oct	Nov	Dec					
Code	1	2	3	4	5	6	7	8	9	O	N	D					

Maximum Ratings @T_A = 25°C unless otherwise specified

Characteristic	Symbol	Value	Unit
Non-Repetitive Peak Reverse Voltage	V _{RM}	100	V
Peak Repetitive Reverse Voltage	V _{RRM}	75	V
Working Peak Reverse Voltage	V _{RWM}		
DC Blocking Voltage	V _R		
RMS Reverse Voltage	V _{R(RMS)}	53	V
Forward Continuous Current (Note 4)	I _{FM}	500	mA
Average Rectified Output Current (Note 4)	I _O	250	mA
Non-Repetitive Peak Forward Surge Current	I _{FSM}	@ t = 1.0μs	4.0
		@ t = 1.0s	1.0

Thermal Characteristics

Characteristic	Symbol	Value	Unit
Power Dissipation (Note 4)	P _D	350	mW
Thermal Resistance Junction to Ambient Air (Note 4)	R _{θJA}	357	°C/W
Operating and Storage Temperature Range	T _J , T _{STG}	-65 to +150	°C

Electrical Characteristics @T_A = 25°C unless otherwise specified

Characteristic	Symbol	Min	Max	Unit	Test Condition
Reverse Breakdown Voltage (Note 5)	V _{(BR)R}	75	—	V	I _R = 2.5μA
Forward Voltage	V _F	0.62	0.72	V	I _F = 5.0mA
		—	0.855		I _F = 10mA
		—	1.0		I _F = 100mA
		—	1.25		I _F = 150mA
Reverse Current (Note 5)	I _R	—	2.5	μA	V _R = 75V
		—	50	μA	V _R = 75V, T _J = 150°C
		—	30	μA	V _R = 25V, T _J = 150°C
		—	25	nA	V _R = 20V
Total Capacitance	C _T	—	4.0	pF	V _R = 0, f = 1.0MHz
Reverse Recovery Time	t _{rr}	—	4.0	ns	I _F = I _R = 10mA, I _{rr} = 0.1 x I _R , R _L = 100Ω

Notes: 4. Part mounted on FR-4 board with recommended pad layout, which can be found on our website at <http://www.diodes.com>.
5. Short duration pulse test used to minimize self-heating effect.

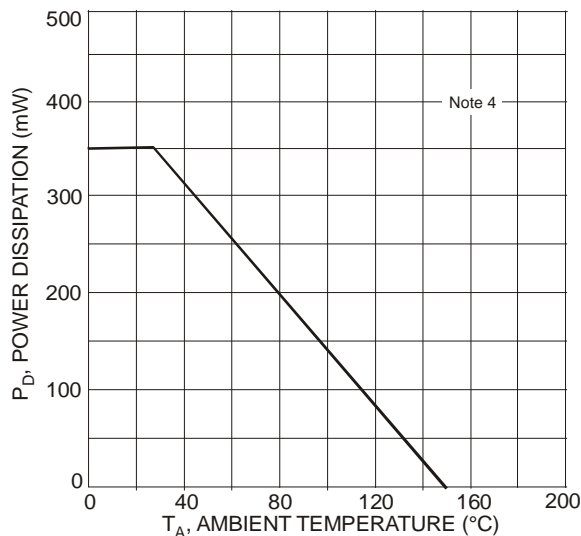

Fig. 1 Power Derating Curve

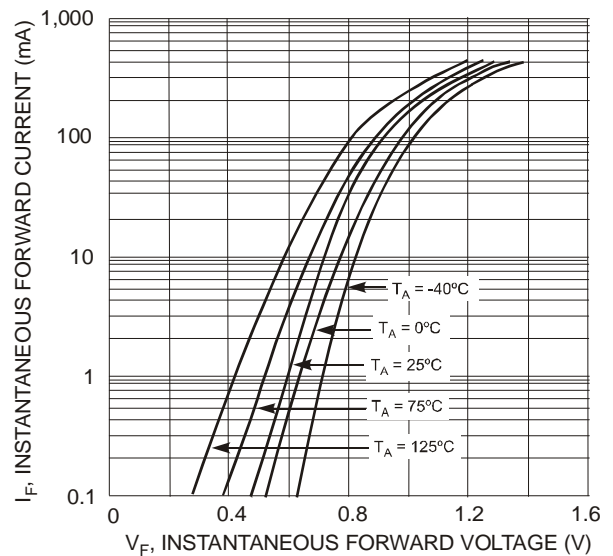

Fig. 2 Typical Forward Characteristics

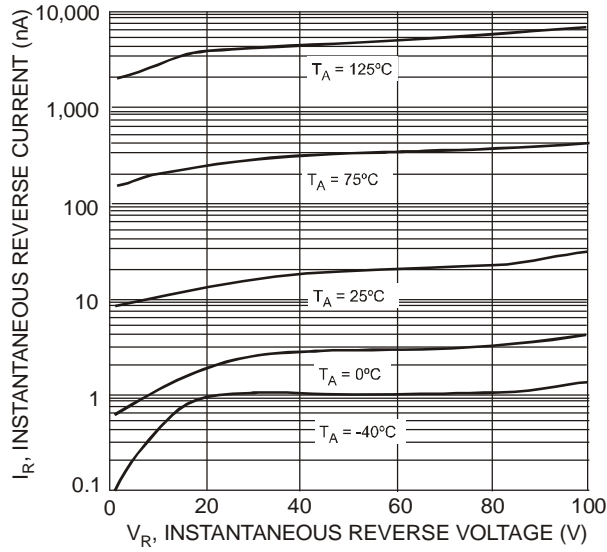

Fig. 3 Typical Reverse Characteristics

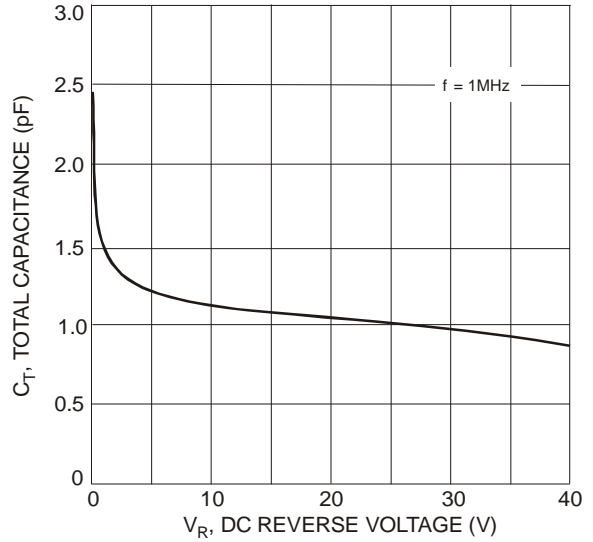
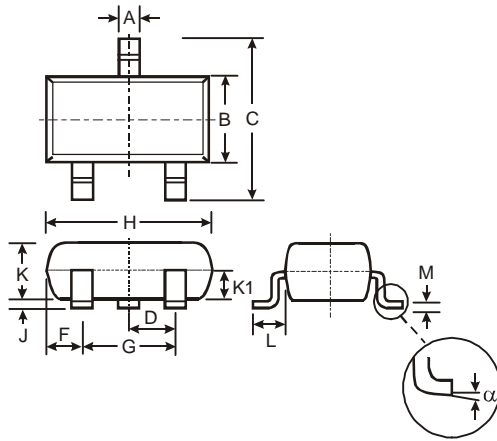

Fig. 4 Total Capacitance vs. Reverse Voltage

Package Outline Dimensions



SOT-23			
Dim	Min	Max	Typ
A	0.37	0.51	0.40
B	1.20	1.40	1.30
C	2.30	2.50	2.40
D	0.89	1.03	0.915
F	0.45	0.60	0.535
G	1.78	2.05	1.83
H	2.80	3.00	2.90
J	0.013	0.10	0.05
K	0.903	1.10	1.00
K1	-	-	0.400
L	0.45	0.61	0.55
M	0.085	0.18	0.11
α	0°	8°	-

All Dimensions in mm

Suggested Pad Layout

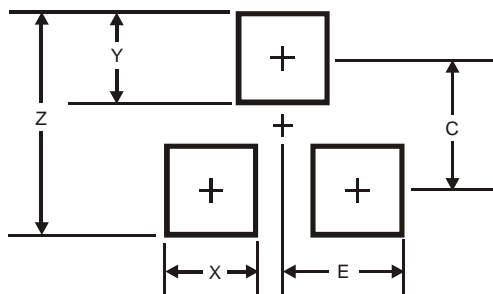

Dimensions	Value (in mm)
Z	2.9
X	0.8
Y	0.9
C	2.0
E	1.35

IMPORTANT NOTICE

DIODES INCORPORATED MAKES NO WARRANTY OF ANY KIND, EXPRESS OR IMPLIED, WITH REGARDS TO THIS DOCUMENT, INCLUDING, BUT NOT LIMITED TO, THE IMPLIED WARRANTIES OF MERCHANTABILITY AND FITNESS FOR A PARTICULAR PURPOSE (AND THEIR EQUIVALENTS UNDER THE LAWS OF ANY JURISDICTION).

Diodes Incorporated and its subsidiaries reserve the right to make modifications, enhancements, improvements, corrections or other changes without further notice to this document and any product described herein. Diodes Incorporated does not assume any liability arising out of the application or use of this document or any product described herein; neither does Diodes Incorporated convey any license under its patent or trademark rights, nor the rights of others. Any Customer or user of this document or products described herein in such applications shall assume all risks of such use and will agree to hold Diodes Incorporated and all the companies whose products are represented on Diodes Incorporated website, harmless against all damages.

Diodes Incorporated does not warrant or accept any liability whatsoever in respect of any products purchased through unauthorized sales channel. Should Customers purchase or use Diodes Incorporated products for any unintended or unauthorized application, Customers shall indemnify and hold Diodes Incorporated and its representatives harmless against all claims, damages, expenses, and attorney fees arising out of, directly or indirectly, any claim of personal injury or death associated with such unintended or unauthorized application.

Products described herein may be covered by one or more United States, international or foreign patents pending. Product names and markings noted herein may also be covered by one or more United States, international or foreign trademarks.

LIFE SUPPORT

Diodes Incorporated products are specifically not authorized for use as critical components in life support devices or systems without the express written approval of the Chief Executive Officer of Diodes Incorporated. As used herein:

A. Life support devices or systems are devices or systems which:

1. are intended to implant into the body, or
2. support or sustain life and whose failure to perform when properly used in accordance with instructions for use provided in the labeling can be reasonably expected to result in significant injury to the user.

B. A critical component is any component in a life support device or system whose failure to perform can be reasonably expected to cause the failure of the life support device or to affect its safety or effectiveness.

Customers represent that they have all necessary expertise in the safety and regulatory ramifications of their life support devices or systems, and acknowledge and agree that they are solely responsible for all legal, regulatory and safety-related requirements concerning their products and any use of Diodes Incorporated products in such safety-critical, life support devices or systems, notwithstanding any devices- or systems-related information or support that may be provided by Diodes Incorporated. Further, Customers must fully indemnify Diodes Incorporated and its representatives against any damages arising out of the use of Diodes Incorporated products in such safety-critical, life support devices or systems.

Copyright © 2011, Diodes Incorporated

www.diodes.com



Стандарт Электрон Связь

Мы молодая и активно развивающаяся компания в области поставок электронных компонентов. Мы поставляем электронные компоненты отечественного и импортного производства напрямую от производителей и с крупнейших складов мира.

Благодаря сотрудничеству с мировыми поставщиками мы осуществляем комплексные и плановые поставки широчайшего спектра электронных компонентов.

Собственная эффективная логистика и склад в обеспечивает надежную поставку продукции в точно указанные сроки по всей России.

Мы осуществляем техническую поддержку нашим клиентам и предпродажную проверку качества продукции. На все поставляемые продукты мы предоставляем гарантию .

Осуществляем поставки продукции под контролем ВП МО РФ на предприятия военно-промышленного комплекса России , а также работаем в рамках 275 ФЗ с открытием отдельных счетов в уполномоченном банке. Система менеджмента качества компании соответствует требованиям ГОСТ ISO 9001.

Минимальные сроки поставки, гибкие цены, неограниченный ассортимент и индивидуальный подход к клиентам являются основой для выстраивания долгосрочного и эффективного сотрудничества с предприятиями радиоэлектронной промышленности, предприятиями ВПК и научно-исследовательскими институтами России.

С нами вы становитесь еще успешнее!

Наши контакты:

Телефон: +7 812 627 14 35

Электронная почта: sales@st-electron.ru

Адрес: 198099, Санкт-Петербург,
Промышленная ул, дом № 19, литера Н,
помещение 100-Н Офис 331