

EMILY-D

~11° diffused spot beam. 14.74 mm high lens.

TECHNICAL SPECIFICATIONS:

Dimensions	Ø 26.0 mm
Height	14.7 mm
Fastening	tape, pin
ROHS compliant	yes ⓘ

MATERIAL SPECIFICATIONS:

Component	Type	Material	Colour	Finish
EMILY-D	Single lens	PMMA		
SPUTNIK-TAPE	Tape	PU tape		



ORDERING INFORMATION:

Component		Qty in box	MOQ	MPQ	Box weight (kg)
CA12062_EMILY-D	Single lens	1690	260	130	10.5
» Box size: 480 x 280 x 300 mm					

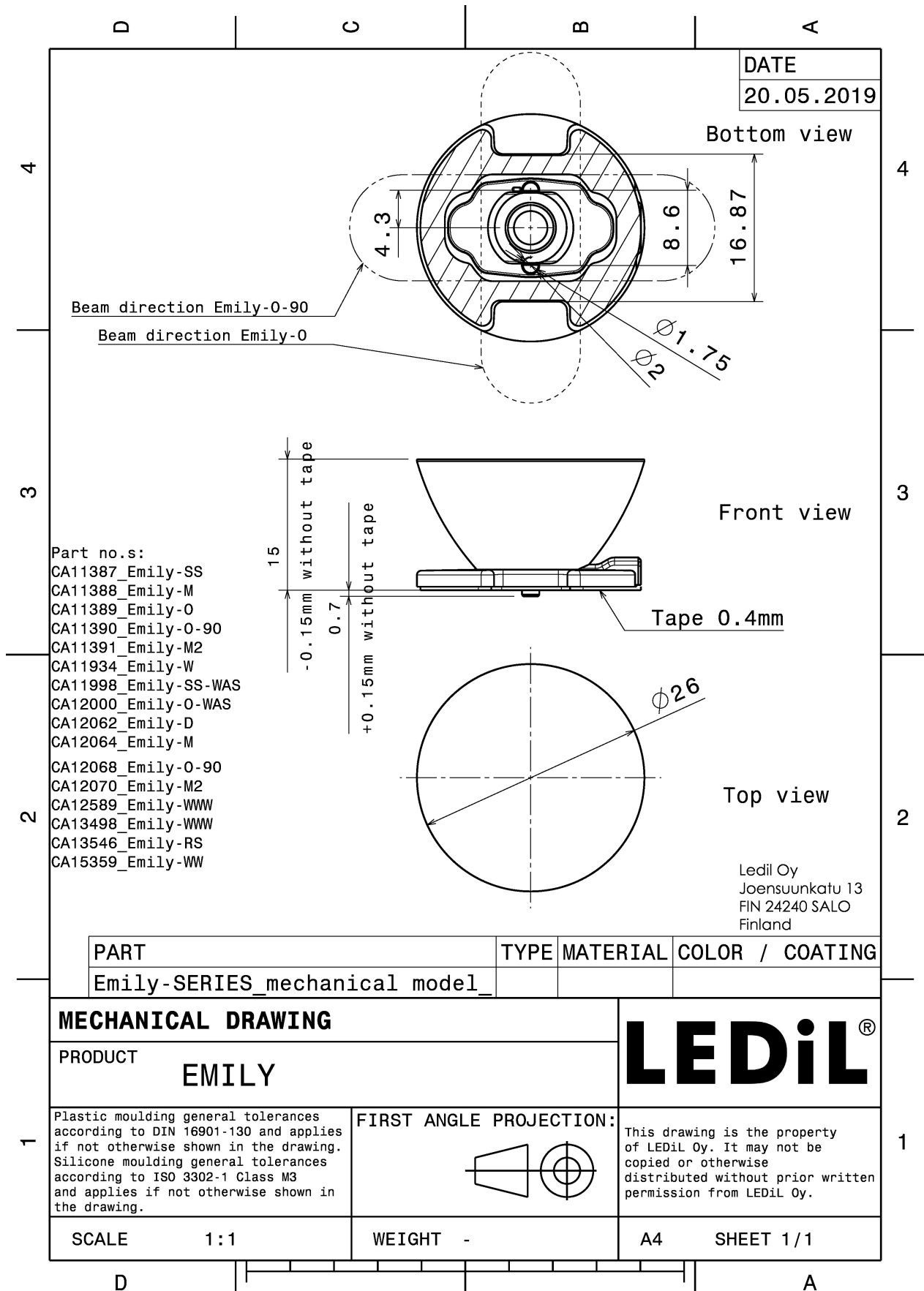

PHOTOMETRIC DATA (MEASURED):

CREE

LED XB-H
 FWHM 10.0°
 Efficiency 89 %
 Peak intensity 17.500 cd/lm
 LEDs/each optic 1
 Light colour White
 Required components:

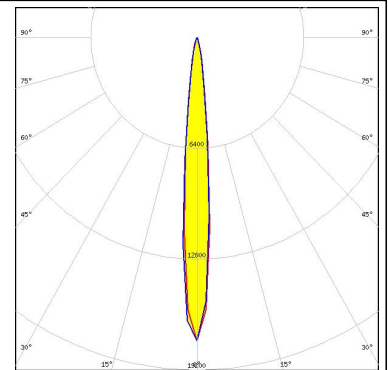

CREE

LED XD16
 FWHM 8.0°
 Efficiency 92 %
 Peak intensity 18.400 cd/lm
 LEDs/each optic 1
 Light colour White
 Required components:

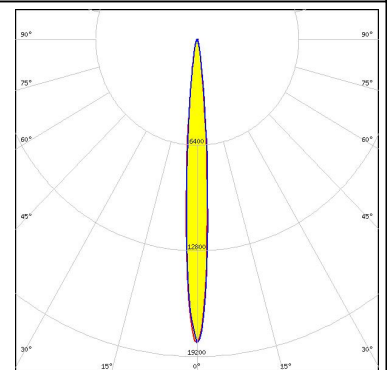

CREE

LED XHP35 HI
 FWHM 11.0°
 Efficiency 92 %
 Peak intensity 14.500 cd/lm
 LEDs/each optic 1
 Light colour White
 Required components:

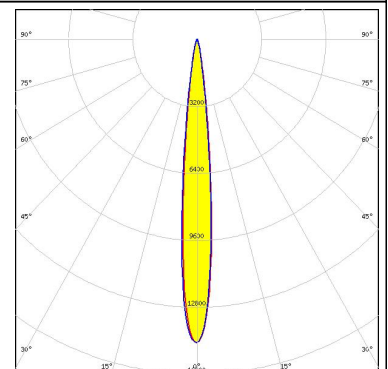
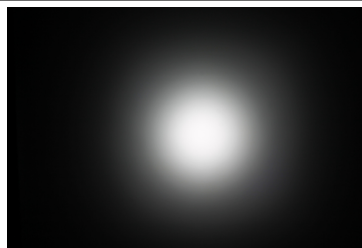

CREE

LED XM-L
 FWHM 14.0°
 Efficiency 90 %
 Peak intensity 10.100 cd/lm
 LEDs/each optic 1
 Light colour White
 Required components:

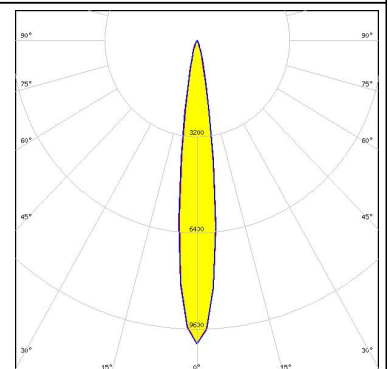

PHOTOMETRIC DATA (MEASURED):

CREE

LED XM-L2
 FWHM 14.0°
 Efficiency 90 %
 Peak intensity 10.200 cd/lm
 LEDs/each optic 1
 Light colour White
 Required components:

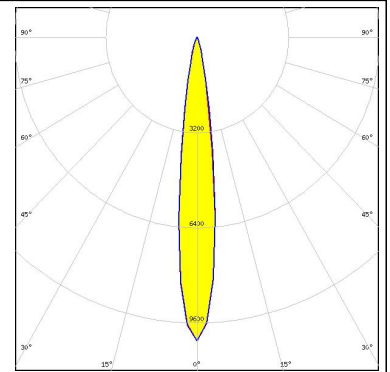

CREE

LED XP-E2
 FWHM 8.0°
 Efficiency 87 %
 Peak intensity 27.300 cd/lm
 LEDs/each optic 1
 Light colour White
 Required components:

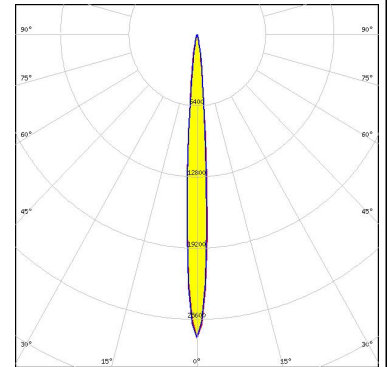

CREE

LED XP-G2
 FWHM 10.0°
 Efficiency 90 %
 Peak intensity 20.800 cd/lm
 LEDs/each optic 1
 Light colour White
 Required components:

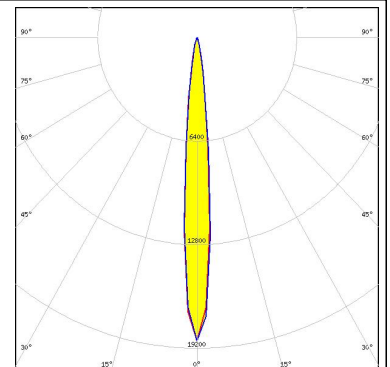

CREE

LED XP-G3
 FWHM 11.0°
 Efficiency 94 %
 Peak intensity 13.000 cd/lm
 LEDs/each optic 1
 Light colour White
 Required components:

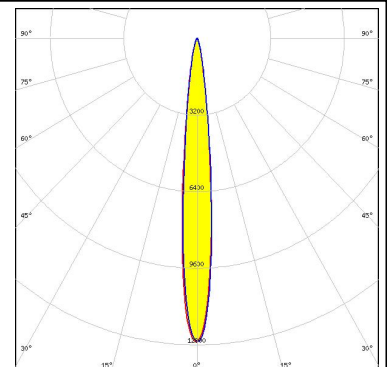

PHOTOMETRIC DATA (MEASURED):



LED XP-L HD
 FWHM 13.0°
 Efficiency 90 %
 Peak intensity 10.200 cd/lm
 LEDs/each optic 1
 Light colour White
 Required components:

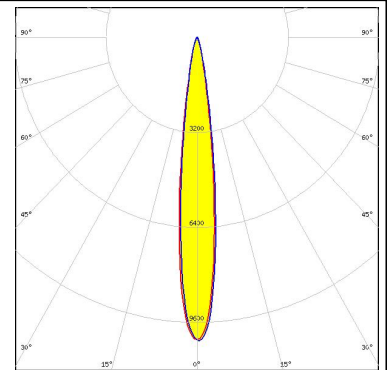

LED XP-L HI
 FWHM 9.0°
 Efficiency 87 %
 Peak intensity 20.000 cd/lm
 LEDs/each optic 1
 Light colour White
 Required components:

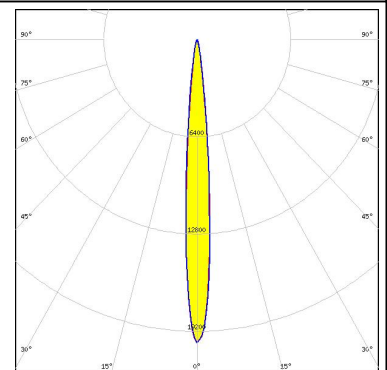

LED XT-E
 FWHM 9.0°
 Efficiency %
 Peak intensity 14.000 cd/lm
 LEDs/each optic 1
 Light colour White
 Required components:



LED LUXEON A
 FWHM 11.0°
 Efficiency 91 %
 Peak intensity cd/lm
 LEDs/each optic 1
 Light colour White
 Required components:

PHOTOMETRIC DATA (MEASURED):

LUMILEDS
 LED LUXEON Rebel ES
 FWHM 10.0°
 Efficiency 91 %
 Peak intensity cd/lm
 LEDs/each optic 1
 Light colour White
 Required components:

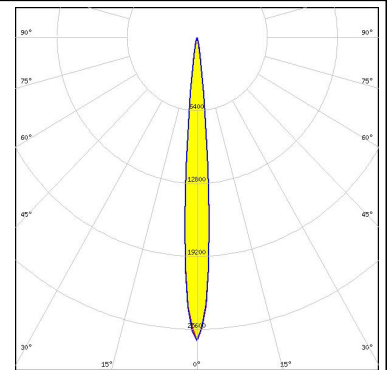

NICHIA
 LED NS9x383
 FWHM 14.0°
 Efficiency 90 %
 Peak intensity 7.900 cd/lm
 LEDs/each optic 1
 Light colour White
 Required components:

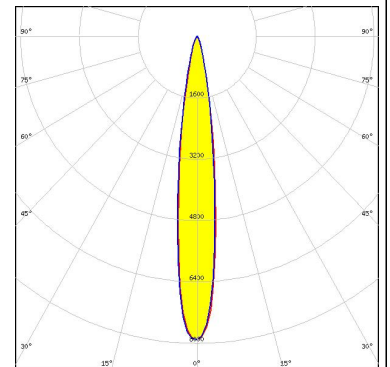

OSRAM
 Opto Semiconductors
 LED OSOLON Square EC
 FWHM 9.0°
 Efficiency 86 %
 Peak intensity 20.060 cd/lm
 LEDs/each optic 1
 Light colour White
 Required components:

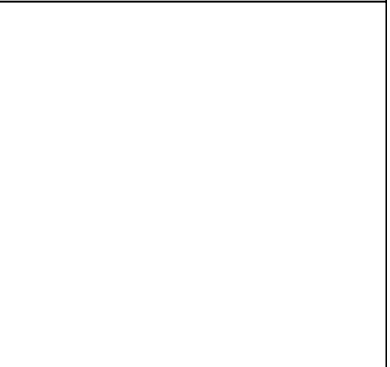
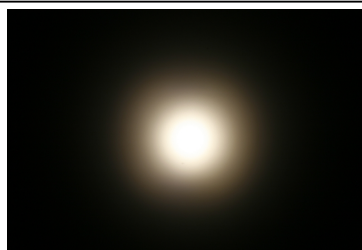

SAMSUNG
 LED LH351B
 FWHM 12.0°
 Efficiency 88 %
 Peak intensity 14.000 cd/lm
 LEDs/each optic 1
 Light colour White
 Required components:

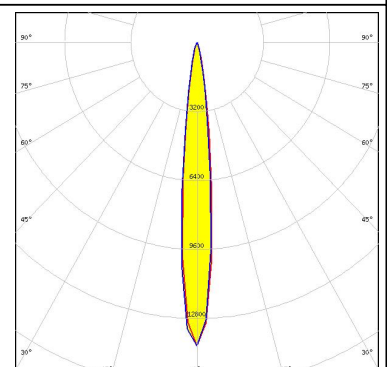

PHOTOMETRIC DATA (MEASURED):

SAMSUNG

LED LH351Z
FWHM 10.0°
Efficiency 88 %
Peak intensity 20.000 cd/lm
LEDs/each optic 1
Light colour White
Required components:

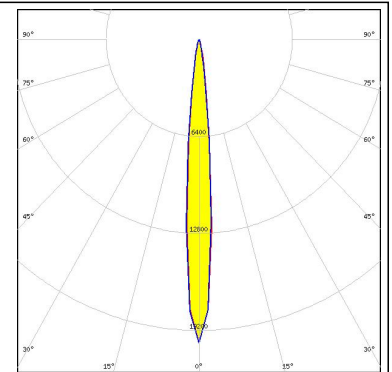

SEOUL SEMICONDUCTOR
LED Z5M1/Z5M2
FWHM 10.0°
Efficiency 94 %
Peak intensity 18.200 cd/lm
LEDs/each optic 1
Light colour White
Required components:

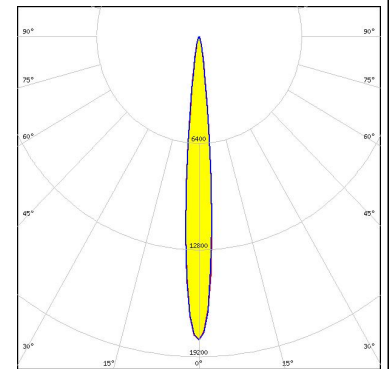

SEOUL SEMICONDUCTOR
LED Z8Y22P
FWHM 11.0°
Efficiency 93 %
Peak intensity 11.300 cd/lm
LEDs/each optic 1
Light colour White
Required components:

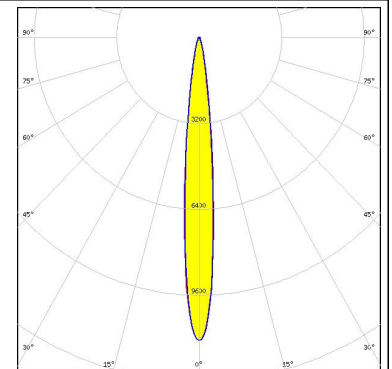
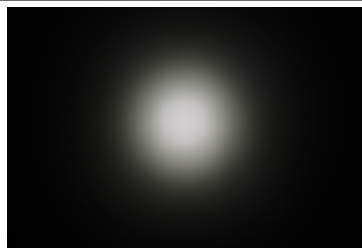

PHOTOMETRIC DATA (SIMULATED):

CREE 

LED XM-L HVW
 FWHM 14.0°
 Efficiency %
 Peak intensity cd/lm
 LEDs/each optic 1
 Light colour White
 Required components:

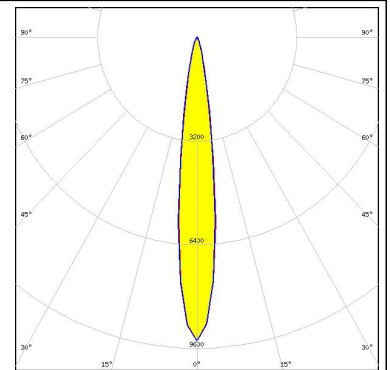

CREE 

LED XP-G2 HE
 FWHM 12.0°
 Efficiency 95 %
 Peak intensity 15.232 cd/lm
 LEDs/each optic 1
 Light colour White
 Required components:

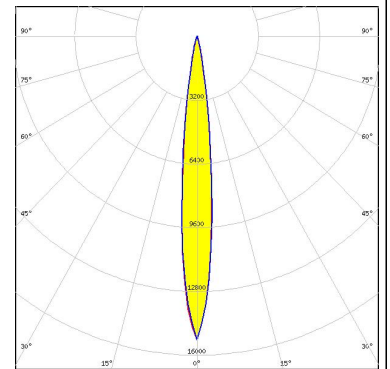

OSRAM
Opto Semiconductors

LED OSLON Square CSSRM2/CSSRM3
 FWHM 9.9°
 Efficiency 94 %
 Peak intensity 22.500 cd/lm
 LEDs/each optic 1
 Light colour White
 Required components:

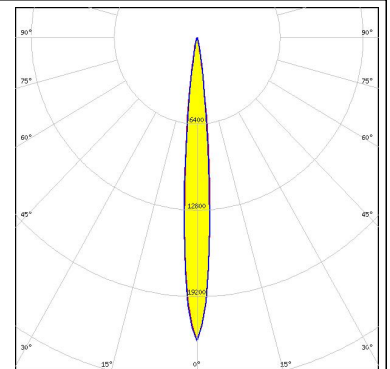

GENERAL INFORMATION:

NOTE: The typical beam angle will be changed by different color, chip size and chip position tolerance. The typical total beam angle is the full angle measured where the luminous intensity is half of the peak value.

MATERIALS:

As part of our continuous research and improvement processes, and to ensure the best possible quality and availability of our products, LEDiL reserves the right to change material grades without notice.

PRODUCT DATA USER AGREEMENT AND DISCLAIMER:

The measured data in the provided downloadable LEDiL Product Datasheets and Mechanical 2D-Drawings is rounded and provided as reference for planning. LEDiL Oy's optical specifications have been verified by conducting performance testing of the products in accordance with the company's quality system. The reported data are averaged results of multiple measurements with typical variation. LEDiL Oy reserves the right to without prior notification make changes and improvements to its products.

LEDiL Oy assumes neither warranty, nor guarantee nor any other liability of any kind for the contents and correctness of the provided data. The provided data has been generated with highest diligence but the provided data may in reality not represent the complete possible variation range of all intrinsic parameters. Therefore, in certain cases a deviation from the provided data could occur.

LEDiL Oy reserves the right to undertake technical changes of its products without further notification which could lead to changes in the provided data. LEDiL Oy assumes no liability of any kind for the possible deviation from any provided data or any other damage resulting from the usage of the provided data.

The user agrees to this disclaimer and user agreement with the download or usage of the provided files.

LEDiL Oy

Joensuunkatu 13
FI-24240 SALO
Finland

LEDiL Inc.

228 West Page Street
Suite D
Sycamore IL 60178
USA

Local sales and technical support

[www.ledil.com/
where_to_buy](http://www.ledil.com/where_to_buy)

Shipping locations

Salo, Finland
Hong Kong, China

Distribution Partners

[www.ledil.com/
where_to_buy](http://www.ledil.com/where_to_buy)



Стандарт Электрон Связь

Мы молодая и активно развивающаяся компания в области поставок электронных компонентов. Мы поставляем электронные компоненты отечественного и импортного производства напрямую от производителей и с крупнейших складов мира.

Благодаря сотрудничеству с мировыми поставщиками мы осуществляем комплексные и плановые поставки широчайшего спектра электронных компонентов.

Собственная эффективная логистика и склад в обеспечивает надежную поставку продукции в точно указанные сроки по всей России.

Мы осуществляем техническую поддержку нашим клиентам и предпродажную проверку качества продукции. На все поставляемые продукты мы предоставляем гарантию .

Осуществляем поставки продукции под контролем ВП МО РФ на предприятия военно-промышленного комплекса России , а также работаем в рамках 275 ФЗ с открытием отдельных счетов в уполномоченном банке. Система менеджмента качества компании соответствует требованиям ГОСТ ISO 9001.

Минимальные сроки поставки, гибкие цены, неограниченный ассортимент и индивидуальный подход к клиентам являются основой для выстраивания долгосрочного и эффективного сотрудничества с предприятиями радиоэлектронной промышленности, предприятиями ВПК и научно-исследовательскими институтами России.

С нами вы становитесь еще успешнее!

Наши контакты:

Телефон: +7 812 627 14 35

Электронная почта: sales@st-electron.ru

Адрес: 198099, Санкт-Петербург,
Промышленная ул, дом № 19, литера Н,
помещение 100-Н Офис 331