

GaAs MMIC SUB HARMONIC MIXER, 37 - 46.5 GHz

Typical Applications

The HMC1093 is ideal for:

- 38 GHz Microwave Radio
- 42 GHz Microwave Radio
- Military End-Use

Features

- Sub-Harmonically Pumped (x4) LO
- Low LO Power: -1 dBm
- High 4LO/RF Isolation: 20 dB
- Wide IF Bandwidth: DC to 7.5 GHz
- Downconversion Applications
- Die Size: 1.45 X 3.85 X 0.1 mm

Functional Diagram

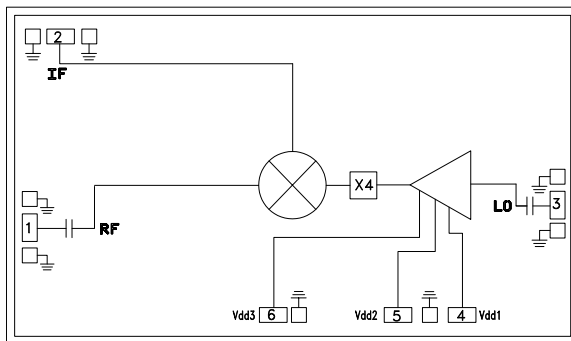

General Description

The HMC1093 chip is a sub-harmonically pumped (x4) MMIC mixer with an integrated LO amplifier. The HMC1093 chip is ideal for use as a downconverter with 37 to 46.5 GHz at the RF port and DC to 7.5 GHz at the IF port. The HMC1093 utilizes a GaAs PHEMT technology and delivers excellent 4LO to RF isolation of 20 dB, which eliminates the need for additional filtering. The LO amplifier is a single bias (+3V) two-stage design requiring only -1 dBm of LO power. The RF and LO ports are DC blocked and matched to 50 Ohms for ease of use. All data shown herein is measured with the chip in a 50 Ohm test fixture connected via 0.025mm (1 mil) wire bonds of minimal length <0.31 mm (<12 mils).

Electrical Specifications, $T_A = +25^\circ\text{C}$, $V_{dd} = +3\text{V}$, USB ^[1]

| Parameter | Min. | Typ. | Max. | Min. | Typ. | Max. | Min. | Typ. | Max. | Units |
|-------------------------------------------------|---------|------|----------|------|-----------|------|------|------|------|-------|
| RF Frequency Range | 37 - 40 | | 40 - 43 | | 43 - 46.5 | | | | | |
| LO Frequency Range | | | 8.5 - 11 | | | | | | | |
| IF Frequency Range | | | DC - 7.5 | | | | | | | |
| Conversion Loss | | 14 | 16 | | 11 | 13 | | 9 | 11 | dB |
| 4LO to RF Isolation | | 22 | | | 15 | | | 15 | | dB |
| 4LO to IF Isolation | | 16 | | | 18 | | | 25 | | dB |
| Input Third Order Intercept (IP3) | | 30 | | | 26 | | | 21 | | dB |
| Input Power for 1 dB Compression ^[2] | | 20 | | | 18 | | | 16 | | dBm |
| I _{dd} | 140 | 160 | 210 | 140 | 160 | 210 | 140 | 160 | 210 | mA |

[1] Unless otherwise noted, all measurements performed as a downconverter with LO = -1 dBm.

[2] Data taken at IF = 7.5 GHz, USB.

**GaAs MMIC SUB HARMONIC
MIXER, 37 - 46.5 GHz**

Data taken at IF = 1 GHz, USB

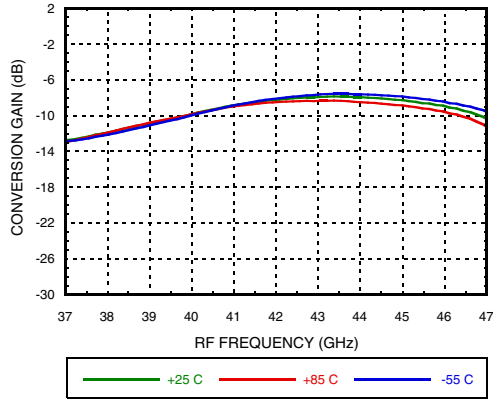
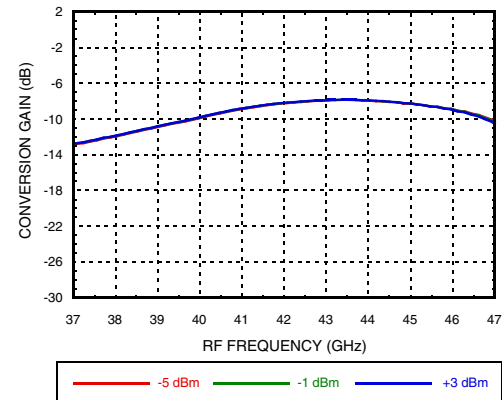
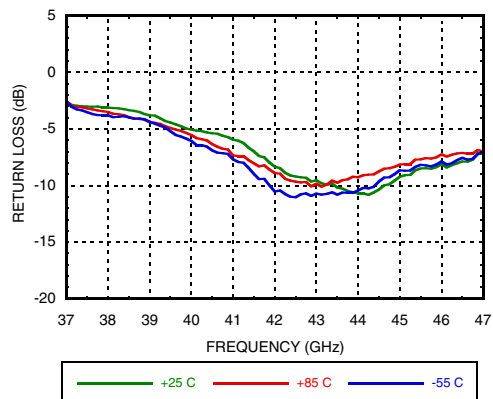
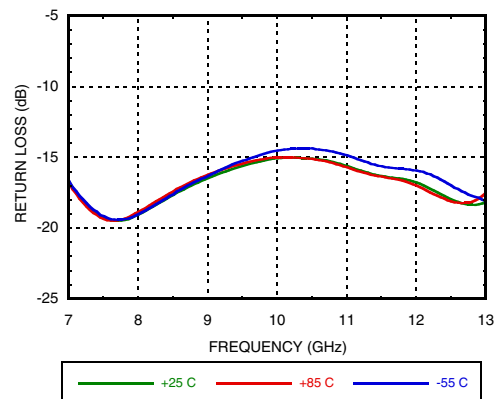
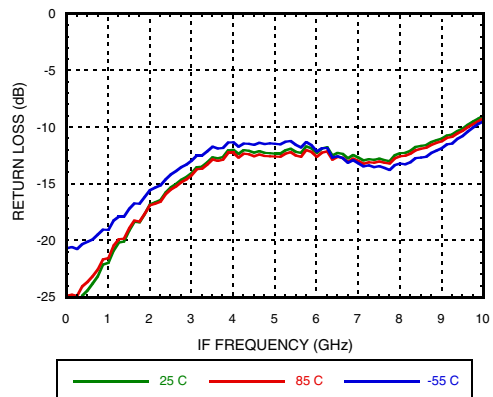
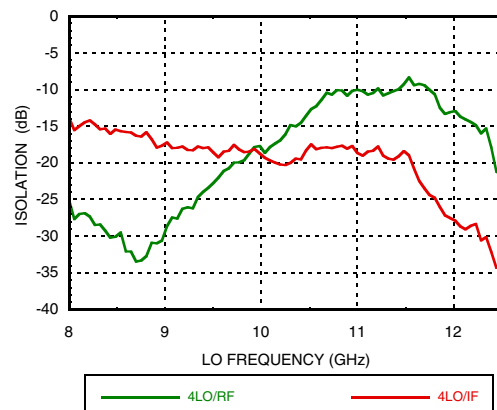
Conversion Loss vs. Temperature

Conversion Loss vs. LO Drive

RF Return Loss

LO Return Loss vs. Temperature

IF Return Loss

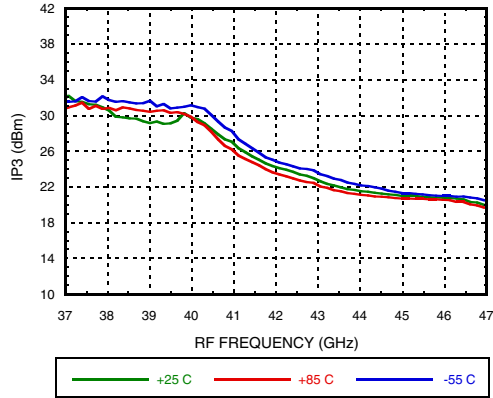
4LO Isolation

GaAs MMIC SUB HARMONIC MIXER, 37 - 46.5 GHz



Data taken at IF = 1 GHz, USB

Input IP3 vs. Temperature



Output IP3 vs. Temperature

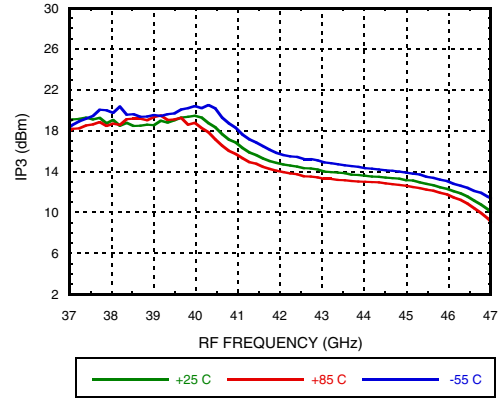

Input IP3 vs. LO Power

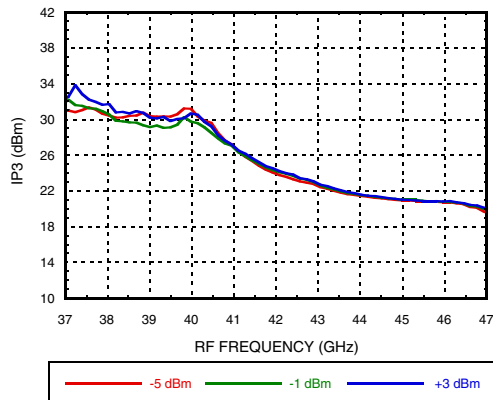

Output IP3 vs. LO Power

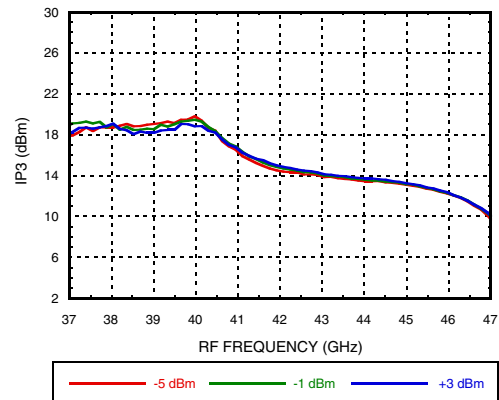

**GaAs MMIC SUB HARMONIC
MIXER, 37 - 46.5 GHz**

 Data taken at $IF = 2\text{ GHz}$, USB

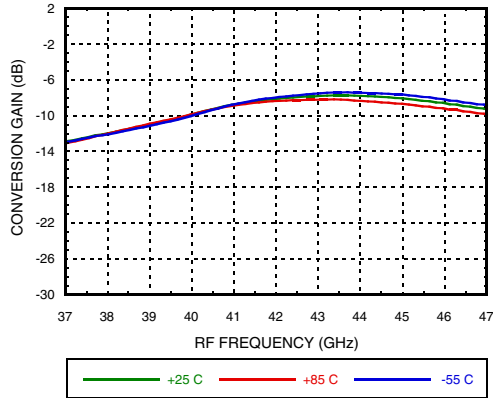
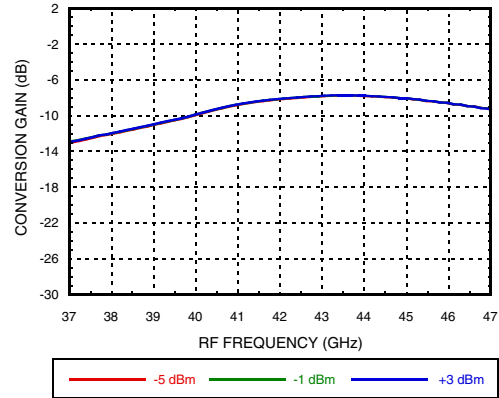
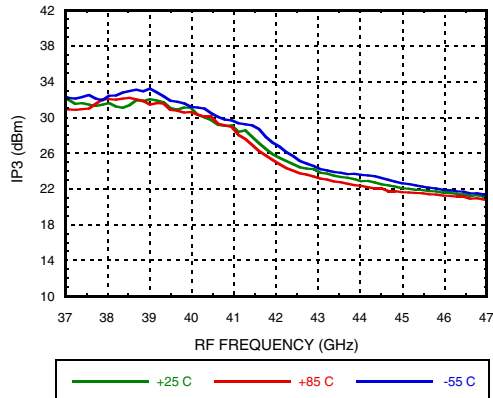
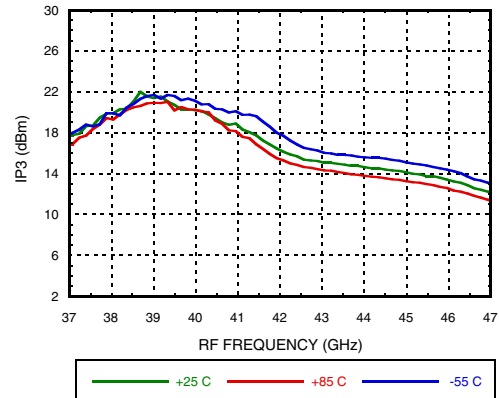
Conversion Loss vs. Temperature

Conversion Loss vs. LO Drive

Input IP3 vs. Temperature

Output IP3 vs. Temperature

GaAs MMIC SUB HARMONIC MIXER, 37 - 46.5 GHz

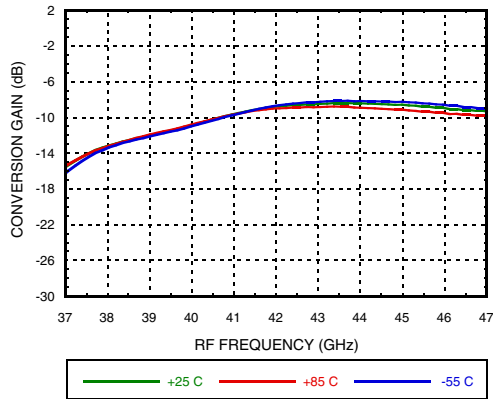

Data taken at IF = 3.5 GHz, USB

Conversion Loss vs. Temperature



Conversion Loss vs. LO Drive

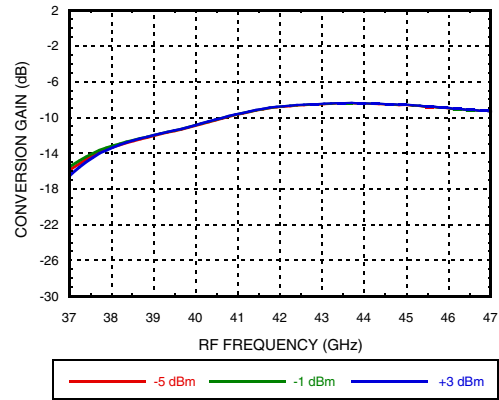

Input IP3 vs. Temperature

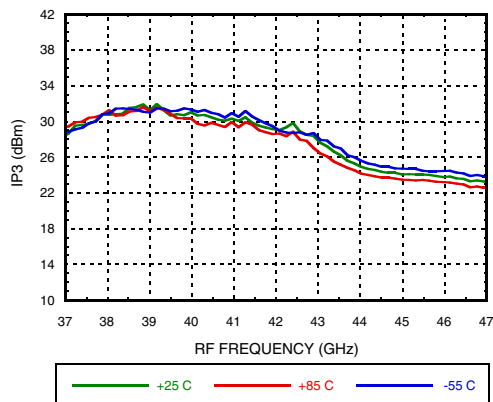

Output IP3 vs. Temperature

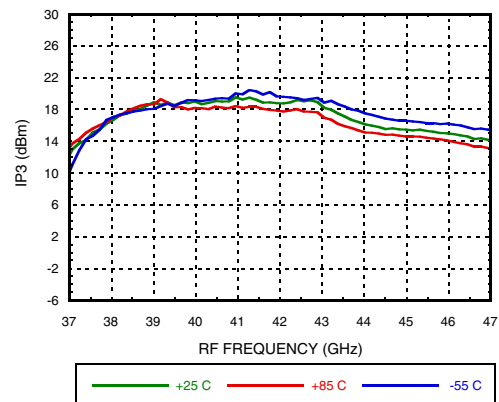



**GaAs MMIC SUB HARMONIC
MIXER, 37 - 46.5 GHz**

Data taken at IF = 7 GHz, USB

Conversion Loss vs. Temperature

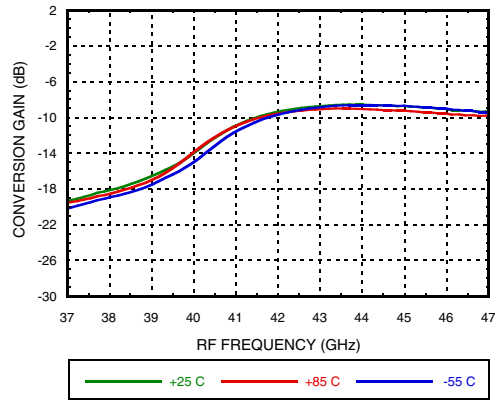

Conversion Loss vs. LO Drive

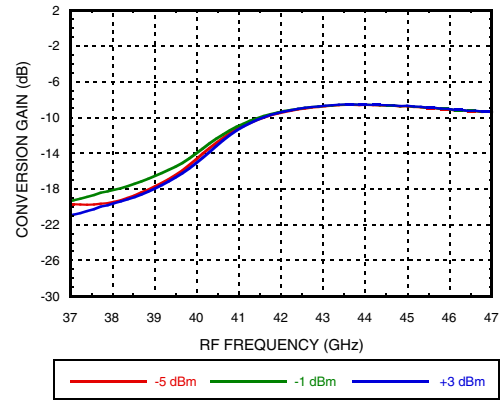

Input P1dB vs. Temperature [1]

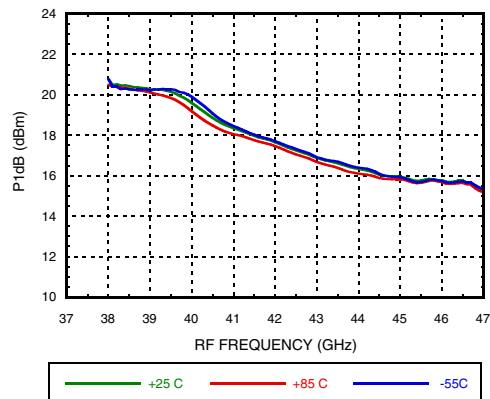

Output P1dB vs. Temperature [1]

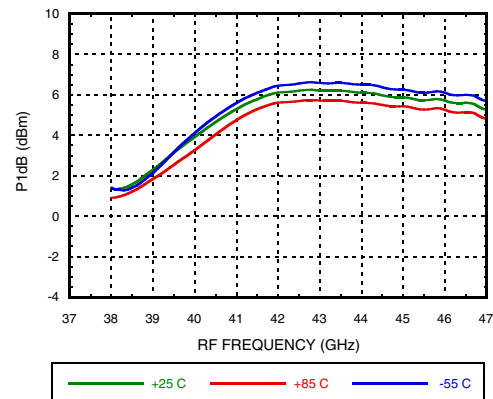

Input IP3 vs. Temperature

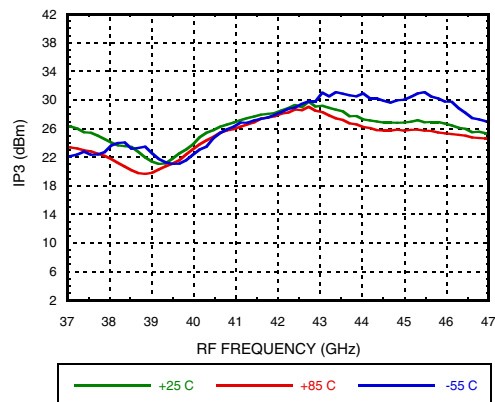

Output IP3 vs. Temperature

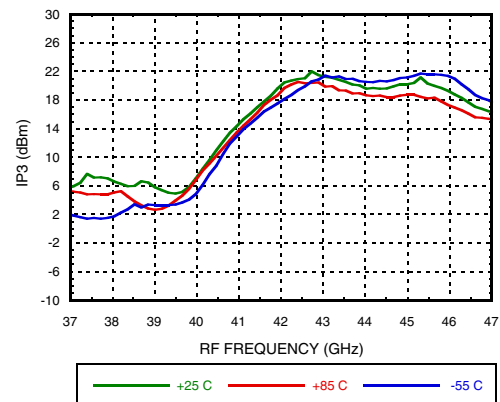

[1] Data taken at IF = 7.5 GHz, USB



GaAs MMIC SUB HARMONIC MIXER, 37 - 46.5 GHz

MIXERS - SUB HARMONIC - CHIP

Absolute Maximum Ratings

| | |
|---------------------------------------------------------------------------|----------------------|
| Bias Voltage | +3.5V |
| RF Input Power | +18dBm |
| LO Input Power | +5dBm |
| Channel Temperature | 175 °C |
| Continuous P _{diss} (T = 85 °C) (derate 15mW/ °C above 85 °C) | 1.6 |
| Thermal Resistance (R _{TH}) (channel to die bottom) | 66.7 °C/W |
| Operating Temperature | -55°C to +85°C |
| Storage Temperature | -65°C to 125°C |
| ESD Sensitivity (HBM) | Class 0, Passed 150V |



**ELECTROSTATIC SENSITIVE DEVICE
OBSERVE HANDLING PRECAUTIONS**

Outline Drawing

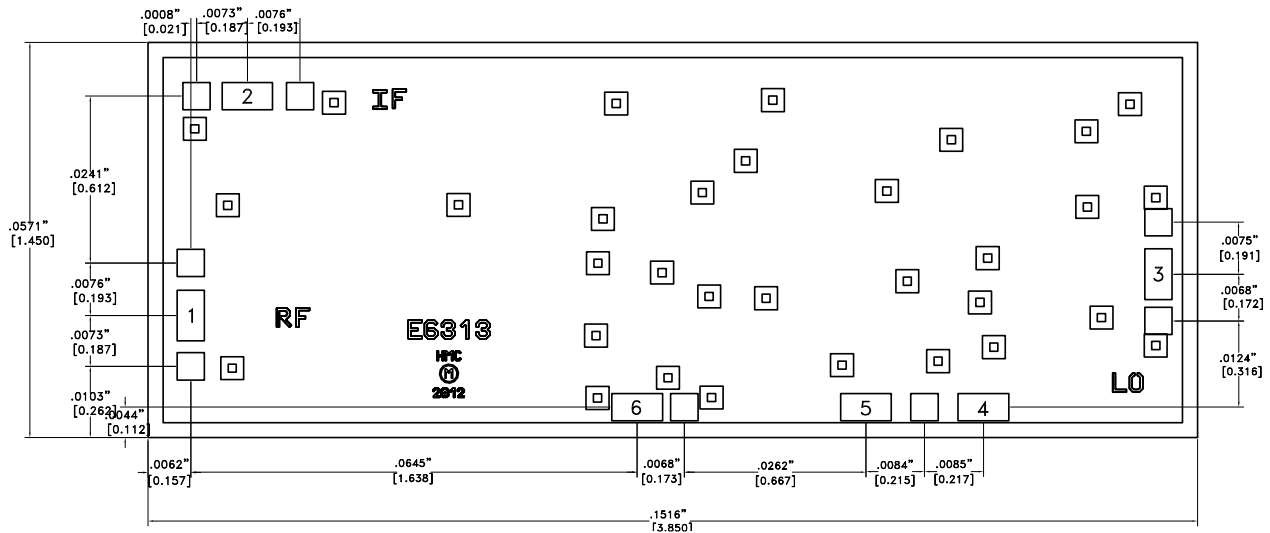

NOTES:

1. ALL DIMENSIONS ARE IN INCHES [MM]
2. DIE THICKNESS IS .004"
3. TYPICAL BOND PAD IS 0.0026" [0.066] SQUARE
4. BACKSIDE METALLIZATION: GOLD
5. BOND PAD METALLIZATION: GOLD
6. BACKSIDE METAL IS GROUND.
7. CONNECTION NOT REQUIRED FOR UNLABELED BOND PADS.
8. OVERALL DIE SIZE ± .002



Die Packaging Information [1]

| Standard | Alternate |
|-----------------|-----------|
| GP-2 (Gel Pack) | [2] |

[1] Refer to the "Packaging Information" section for die packaging dimensions.

[2] For alternate packaging information contact Hittite Microwave Corporation.

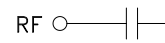
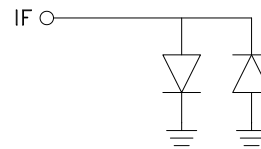
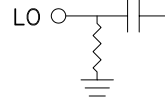
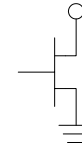
Pad Descriptions

| Pad Number | Function | Description | Pad Schematic |
|------------|------------------|--------------------------------------------------------------------------------------------------------------|--------------------------------------------------------------------------------------|
| 1 | RF | This pad is AC coupled and matched to 50 Ohms. |  |
| 2 | IF | This pad is DC coupled and matched to 50 Ohms. |  |
| 3 | LO | This pad is AC coupled and matched to 50 Ohms. |  |
| 4, 5, 6 | Vdd1, Vdd2, Vdd3 | Power Supply Voltage for the LO Amplifier. External bypass capacitors 100pF, 0.01uF, and 4.7uF are required. |  |
| Die Bottom | Ground | Die bottom must be connected to RF/DC ground. |  |

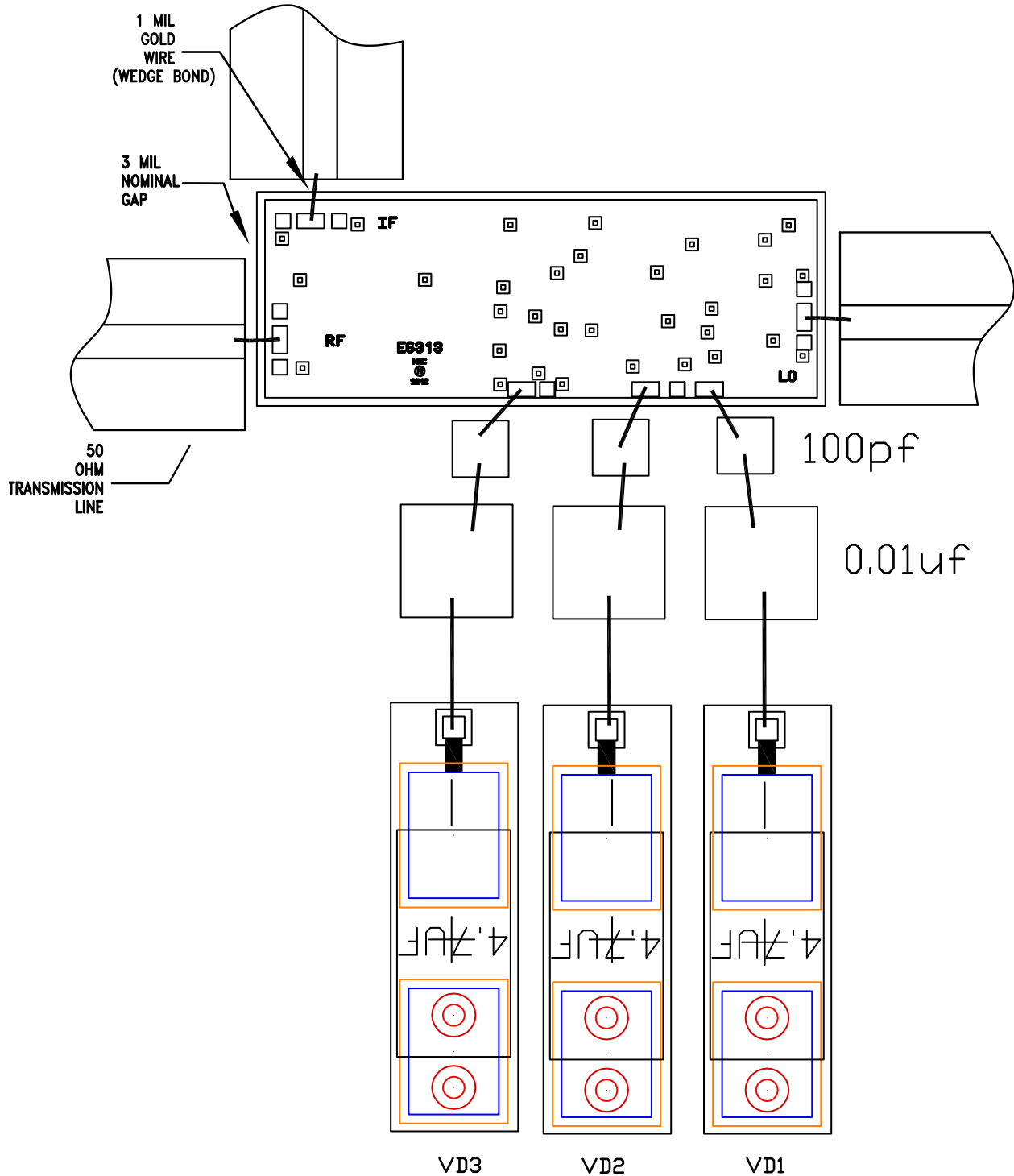
**GaAs MMIC SUB HARMONIC
MIXER, 37 - 46.5 GHz**
Assembly Diagram

GaAs MMIC SUB HARMONIC MIXER, 37 - 46.5 GHz

Mounting & Bonding Techniques for Millimeterwave GaAs MMICs

The die should be attached directly to the ground plane eutectically or with conductive epoxy (see HMC general Handling, Mounting, Bonding Note).

50 Ohm Microstrip transmission lines on 0.127mm (5 mil) thick alumina thin film substrates are recommended for bringing RF to and from the chip (Figure 1). If 0.254mm (10 mil) thick alumina thin film substrates must be used, the die should be raised 0.150mm (6 mils) so that the surface of the die is coplanar with the surface of the substrate. One way to accomplish this is to attach the 0.102mm (4 mil) thick die to a 0.150mm (6 mil) thick molybdenum heat spreader (moly-tab) which is then attached to the ground plane (Figure 2).

Microstrip substrates should be located as close to the die as possible in order to minimize bond wire length. Typical die-to-substrate spacing is 0.076mm to 0.152 mm (3 to 6 mils).

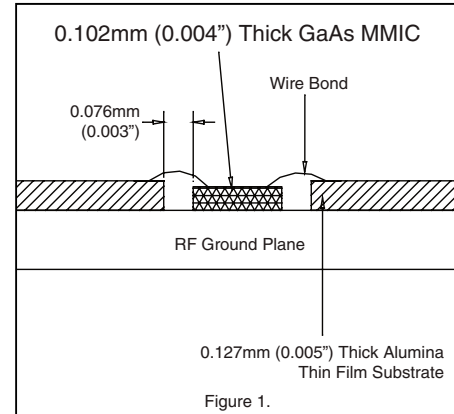

Handling Precautions

Follow these precautions to avoid permanent damage.

Storage: All bare die are placed in either Waffle or Gel based ESD protective containers, and then sealed in an ESD protective bag for shipment. Once the sealed ESD protective bag has been opened, all die should be stored in a dry nitrogen environment.

Cleanliness: Handle the chips in a clean environment. DO NOT attempt to clean the chip using liquid cleaning systems.

Static Sensitivity: Follow ESD precautions to protect against > ± 250V ESD strikes.

Transients: Suppress instrument and bias supply transients while bias is applied. Use shielded signal and bias cables to minimize inductive pick-up.

General Handling: Handle the chip along the edges with a vacuum collet or with a sharp pair of bent tweezers. The surface of the chip may have fragile air bridges and should not be touched with vacuum collet, tweezers, or fingers.

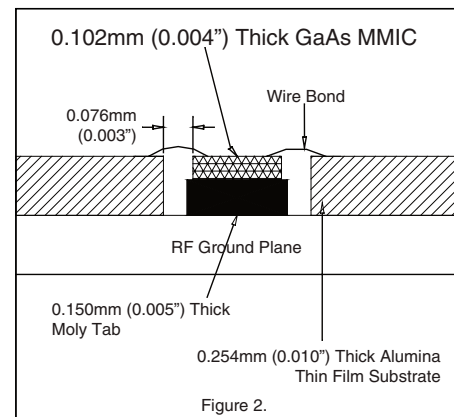

Mounting

The chip is back-metallized and can be die mounted with AuSn eutectic preforms or with electrically conductive epoxy. The mounting surface should be clean and flat.

Eutectic Die Attach: A 80/20 gold tin preform is recommended with a work surface temperature of 255 °C and a tool temperature of 265 °C. When hot 90/10 nitrogen/hydrogen gas is applied, tool tip temperature should be 290 °C. DO NOT expose the chip to a temperature greater than 320 °C for more than 20 seconds. No more than 3 seconds of scrubbing should be required for attachment.

Epoxy Die Attach: Apply a minimum amount of epoxy to the mounting surface so that a thin epoxy fillet is observed around the perimeter of the chip once it is placed into position. Cure epoxy per the manufacturer's schedule.

Wire Bonding

Ball or wedge bond with 0.025mm (1 mil) diameter pure gold wire. Thermosonic wirebonding with a nominal stage temperature of 150 °C and a ball bonding force of 40 to 50 grams or wedge bonding force of 18 to 22 grams is recommended. Use the minimum level of ultrasonic energy to achieve reliable wirebonds. Wirebonds should be started on the chip and terminated on the package or substrate. All bonds should be as short as possible <0.31mm (12 mils).



Стандарт Электрон Связь

Мы молодая и активно развивающаяся компания в области поставок электронных компонентов. Мы поставляем электронные компоненты отечественного и импортного производства напрямую от производителей и с крупнейших складов мира.

Благодаря сотрудничеству с мировыми поставщиками мы осуществляем комплексные и плановые поставки широчайшего спектра электронных компонентов.

Собственная эффективная логистика и склад в обеспечивает надежную поставку продукции в точно указанные сроки по всей России.

Мы осуществляем техническую поддержку нашим клиентам и предпродажную проверку качества продукции. На все поставляемые продукты мы предоставляем гарантию .

Осуществляем поставки продукции под контролем ВП МО РФ на предприятия военно-промышленного комплекса России , а также работаем в рамках 275 ФЗ с открытием отдельных счетов в уполномоченном банке. Система менеджмента качества компании соответствует требованиям ГОСТ ISO 9001.

Минимальные сроки поставки, гибкие цены, неограниченный ассортимент и индивидуальный подход к клиентам являются основой для выстраивания долгосрочного и эффективного сотрудничества с предприятиями радиоэлектронной промышленности, предприятиями ВПК и научно-исследовательскими институтами России.

С нами вы становитесь еще успешнее!

Наши контакты:

Телефон: +7 812 627 14 35

Электронная почта: sales@st-electron.ru

Адрес: 198099, Санкт-Петербург,
Промышленная ул, дом № 19, литера Н,
помещение 100-Н Офис 331