

R-SERIES

FEATURES

- **High-temperature durability**

No solder is used in connecting the cathode terminal to the tantalum pellet. Consequently, users can apply direct soldering (wave soldering) and reflow soldering.

- **High adaptability of automatic assembly**

Tape and reel packaging is available in all product lines.

Precise dimensions due to transfer molded encapsulation provides excellent adaptability to automatic placement machines. Eight-millimeter-wide carrier tape packaging, which is used extensively in most machines, is available for capacitors up to 68 μ F (B2-Case).

The A-Case has the same dimensions (3.2 mm x 1.6 mm) as chip resistors and ceramic capacitors.

The A2 Case has the same dimensions (3.2 mm x 1.6 mm x 1.2 mm MAX.) as mini mold Tr.

- **Wide operating temperature range**

The R-Series operating temperature range is -55°C to $+125^{\circ}\text{C}$.

- **IEC qualification approval**

The R-Series* is granted IEC (International Electrotechnical Commission) Qualification Approval in accordance with IEC Quality Assessment System for Electronic Components. * Except for 50-V items and R series Extended type.

Approval number JP154-9, JP154-10, JP154-11

Date of approval September 29, 1987

Detail specification IEC Pub. 384-3-1 JP0001 (QC300801 JP0001)

SPECIFICATIONS

No.	Item	Specification										Test method	
1	Operating temp. range	-55 to +125 °C											
2	Rated voltage	2.5	4	6.3	10	16	20	25	35	50	V.DC		
3	Surge voltage	3.3	5.2	8	13	20	26	33	46	65	V.DC	at 85°C	
4	Derated voltage	1.6	2.5	4	6.3	10	13	16	22	32	V.DC	at 125 °C	
5	Capacitance range	0.047 to 220 μF										at 120 Hz	
6	Capacitance tolerance	±20 % (±10%)										at 120 Hz	
7	Leakage current	0.01 CV (μA) or 0.5 μA whichever is greater										5 min, after rated voltage applied	
8	Dissipation factor	Standard	0.047 to 4.7 μF : 0.04 max. 6.8 to 68 μF : 0.06 max.									at 25 °C, 120 Hz	
		Extended	2.5 V to 10 V : 0.08 max.(0.1 max.)* ³ (0.12max.)* ⁴ 16 V to 35 V : 0.06 max.										
9	Surge voltage test	ΔC/C : ±5 % Dissipation factor : Initial requirement Leakage current : Initial requirement										at 85°C Surge voltage for 30 sec. (Rs = 1 kΩ) Discharge for 5 min. 30 sec. 1000 cycles	
10	High and low stability temperature	Temp.	-55 °C			+85 °C			+125 °C			Step 1 : +25 °C Step 2 : -55 °C Step 3 : +25 °C Step 4 : +85 °C Step 5 : +125 °C Step 6 : +25 °C	
		ΔC/C	±12 %			±12 %			±15 %				
		Dissipation factor	Standard	0.047 to 4.7 μF : 0.08 max. (0.12 max.)*			Initial requirement			Standard 0.047 to 4.7 μF 0.06 max. 6.8 to 68 μF: 0.08 max.			
			Extended	6.8 to 68 μF : 0.1 max. (0.12 max.)* 2.5 V to 10 V: 0.12 max. (0.14 max.)* ³ (0.16 max.)* ⁴ 16 V to 35 V: 0.1 max.						Extended 2.5 V to 10 V: 0.1 max. (0.12 max.)* ³ (0.14 max.)* ⁴ 16 V to 35 V: 0.08 max.			
Leakage current	-			0.1 CV or 5 μA whichever is greater			0.125 CV or 6.25 μA whichever is greater						
11	Temperature cycling test	ΔC/C : ±5 % (±12%) * ² Dissipation factor : initial requirement Leakage current : Initial requirement										-55 to +125 °C 5 cycles	
12	Soldeing heat resistance test	ΔC/C : ±5 % (±12%) * ² Dissipation factor : Initial requirement Leakage current : Initial requirement										Fully immersion to solder, 260 °C, 5 sec.	
13	Humidity test	ΔC/C : ±5 % (±12%) * ² Dissipation factor : 150 % of initial requirement leakage current : Initial requirement										at 40 °C, 90 to 95 % RH 500 H	
14	Load life test	ΔC/C : ±10 %, (±12%) * ² Dissipation factor : Initial requirement Leakage current : Initial requirement										at 85 °C Rated voltage applied 1000 H	
15	Failure rate	λ ₀ = 1% / 1000H										at 85 °C Rated voltage applied 1000H	

LEGEND

CV : Product of capacitance in μF and voltage in V
 $\Delta\text{C}/\text{C}$: Capacitance change ratio

* : Dissipation factor of 0.12 applies to the specific products of R-series Standard in the following product
 4V/3.3 μF , 4.7 μF , 10 μF , 22 μF , 33 μF , 68 μF , 6.3 V/2.2 μF , 3.3 μF , 6.8 μF , 15 μF , 22 μF , 47 μF

*2: Capacitance change of $\pm 12\%$ applies to the specific products of R-series Extended in the following table.

Case code	Product
A2 (U)	2.5 V/4.7 μF , 6.8 μF , 10 μF , 15 μF , 4 V/4.7 μF , 6.8 μF , 10 μF , 6.3 V/3.3 μF , 4.7 μF , 6.8 μF , 10 V/2.2 μF , 3.3 μF , 16 V/1.5 μF , 2.2 μF , 20 V/1 μF , 1.5 μF
A	2.5 V/15 μF , 22 μF , 33 μF , 4 V/10 μF , 15 μF , 22 μF , 6.3 V/6.8 μF , 10 μF , 15 μF , 10 V/4.7 μF , 6.8 μF , 10 μF , 16 V/3.3 μF , 4.7 μF , 20 V/2.2 μF , 3.3 μF , 25 V/1.5 μF , 2.2 μF , 35 V/1 μF , 1.5 μF ,
B2 (S)	2.5 V/33 μF , 47 μF , 68 μF
C	4 V/150 μF , 6.3 V/100 μF , 10V/68 μF

*3: Dissipation factor of marked *3 applies to the specific products of R series Extended in the following table.

Case code	Product
C	4 V/150 μF , 6.3 V/100 μF

*4: Dissipation factor of marked *4 applies to the specific products of R series Extended in the following table.

Case code	Product
A2 (U)	2.5 V/15 μF , 4 V/10 μF

OUTLINE DRAWINGS AND DIMENSIONS

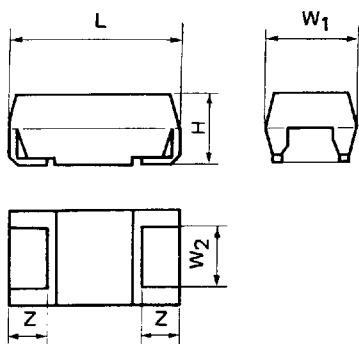

[A2 & A cases]

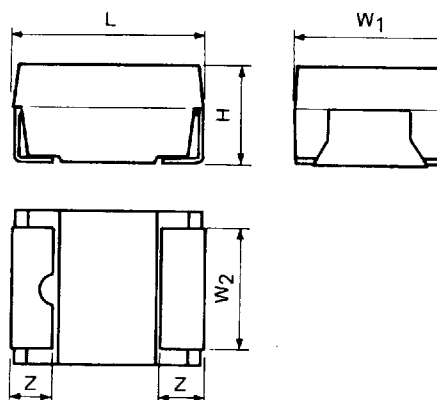

[B2 case]

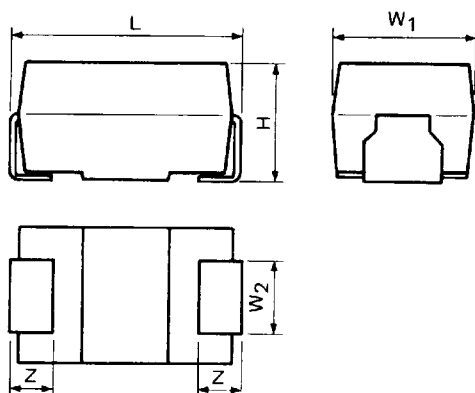

[D2 case]

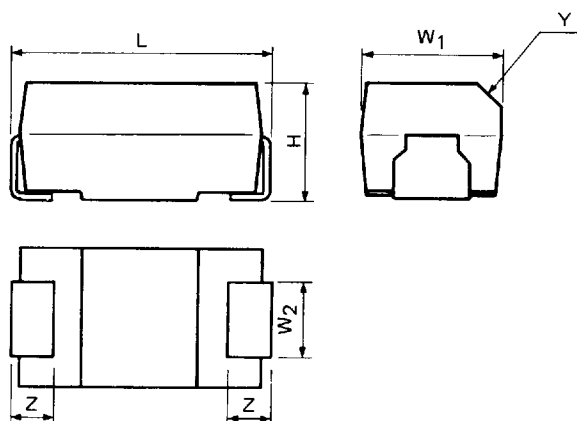

[B, C & D cases]

Unit: mm (inch)

Case code	L	W ₁	W ₂	H	Z	Y
A2 (U)	3.2±0.2 (0.126±0.008)	1.6±0.2 (0.063±0.008)	1.2±0.1 (0.047±0.004)	1.2 MAX. (0.047 MAX.)	0.8±0.3 (0.031±0.012)	—
A	3.2±0.2 (0.126±0.008)	1.6±0.2 (0.063±0.008)	1.2±0.1 (0.047±0.004)	1.6±0.2 (0.063±0.008)	0.8±0.3 (0.031±0.012)	—
B2 (S)	3.5±0.2 (0.138±0.008)	2.8±0.2 (0.110±0.008)	2.3±0.1 (0.091±0.004)	1.9±0.2 (0.075±0.008)	0.8±0.3 (0.031±0.012)	—
B	4.7±0.3 (0.185±0.012)	2.6±0.3 (0.102±0.012)	1.4±0.1 (0.055±0.004)	2.1±0.3 (0.083±0.012)	0.8±0.3 (0.031±0.012)	C 0.4 (0.016)
C	6.0±0.3 (0.236±0.012)	3.2±0.3 (0.126±0.012)	1.8±0.1 (0.071±0.004)	2.5±0.3 (0.098±0.012)	1.3±0.3 (0.051±0.012)	C 0.4 (0.016)
D2 (T)	5.8±0.3 (0.228±0.012)	4.6±0.3 (0.181±0.012)	2.4±0.1 (0.094±0.004)	3.2±0.3 (0.126±0.012)	1.3±0.3 (0.051±0.012)	—
D	7.3±0.3 (0.287±0.012)	4.3±0.3 (0.169±0.012)	2.4±0.1 (0.094±0.004)	2.8±0.3 (0.110±0.012)	1.3±0.3 (0.051±0.012)	C 0.5 (0.020)

MARKING

— Upper face —

[A2 & A Case]

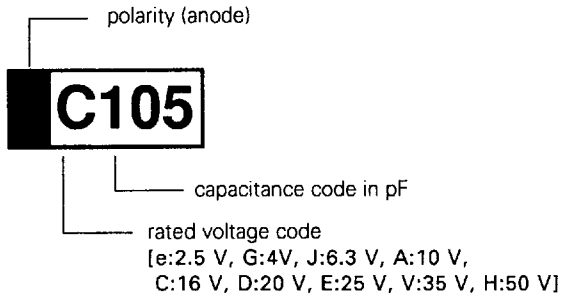

[B Case]

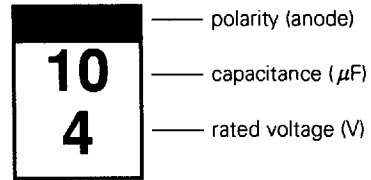

[C & D Case]

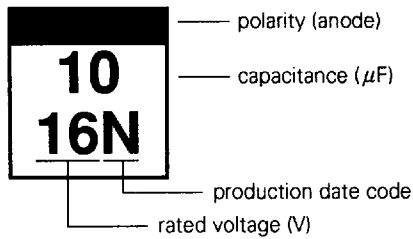

[B2 & D2 Case]

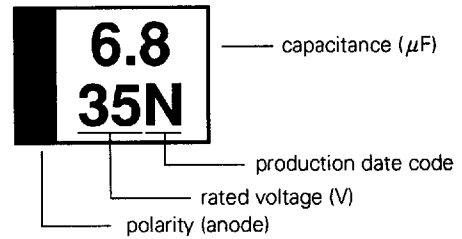

[Marking of production date code]

Y \ M	Jan.	Feb.	Mar.	Apr.	May	Jun.	Jul.	Aug.	Sept.	Oct.	Nov.	Dec.
1994	N	P	Q	R	S	T	U	V	W	X	Y	Z
1995	a	b	c	d	e	f	g	h	j	k	l	m
1996	n	p	q	r	s	t	u	v	w	x	y	z
1997	A	B	C	D	E	F	G	H	J	K	L	M

Date code will resume for beginning in 1998.

PRODUCT LINE-UP AND CASE CODE

R SERIES STANDARD

Rated voltage (Vdc) \ Capacitance (μF)	4	6.3	10	16	20	25	35	50
0.010								
0.015								
0.022								
0.033								
0.047							A	
0.068							A	
0.10							A	A
0.15							A	A
0.22							A	B2
0.33							A	B2
0.47						A	B2 B	B2
0.68					A		B2 B	C
1.0				A			B2 B	C
1.5			A	A		B2 B	C	C
2.2		A	A		B2 B		C	D
3.3	A	A		B2 B		C	C D	D D2
4.7	A		B2 B		C	C	D2 D	D
6.8		B2 B		C	C	D2 D	D2 D	
10	B2 B		C	C	D2 D	D2 D		
15		C	C	D2 D	D2 D			
22	C	C	D2 D	D2 D				
33	C	D2 D	D2 D					
47	D2 D	D2 D						
68	D2 D							

R SERIES EXTENDED

Rated voltage (Vdc) Capacitance (μF)	2.5	4	6.3	10	16	20	25	35
0.1						A2		
0.15						A2		
0.22						A2		
0.33						A2		
0.47						A2		A
0.68					A2	A2		A
1				A2	A2	A2	A	A
1.5			A2	A2	A2	A2 A	A	A B2 B
2.2		A2	A2	A2	A2 A	A	A B2	B2 B
3.3		A2	A2	A2 A	A	A B2	B2 B	B2
4.7	A2	A2	A2 A	A	A B2	B2 B	B2	C
6.8	A2	A2 A	A2 A	A B2	B2 B	B2	C	C
10	A2	A2 A	A B2	A B2 B	B2	B2 C	C	D
15	A2 A	A B2	A B2 B	B2	B2 C	C	D	D
22	A	A B2 B	B2	B2 C	C	C D2 D	D	
33	A B2	B2	B2 C	B2 C	C D2 D	D2 D		
47	B2	B2 C	B2 C	C D2 D	D2 D	D		
68	B2	B2 C	C D2 D	C D2 D	D			
100		C D2 D	C D2 D	D				
150		C D2 D	D					
220		D						

PART NUMBER SYSTEM

Bulk

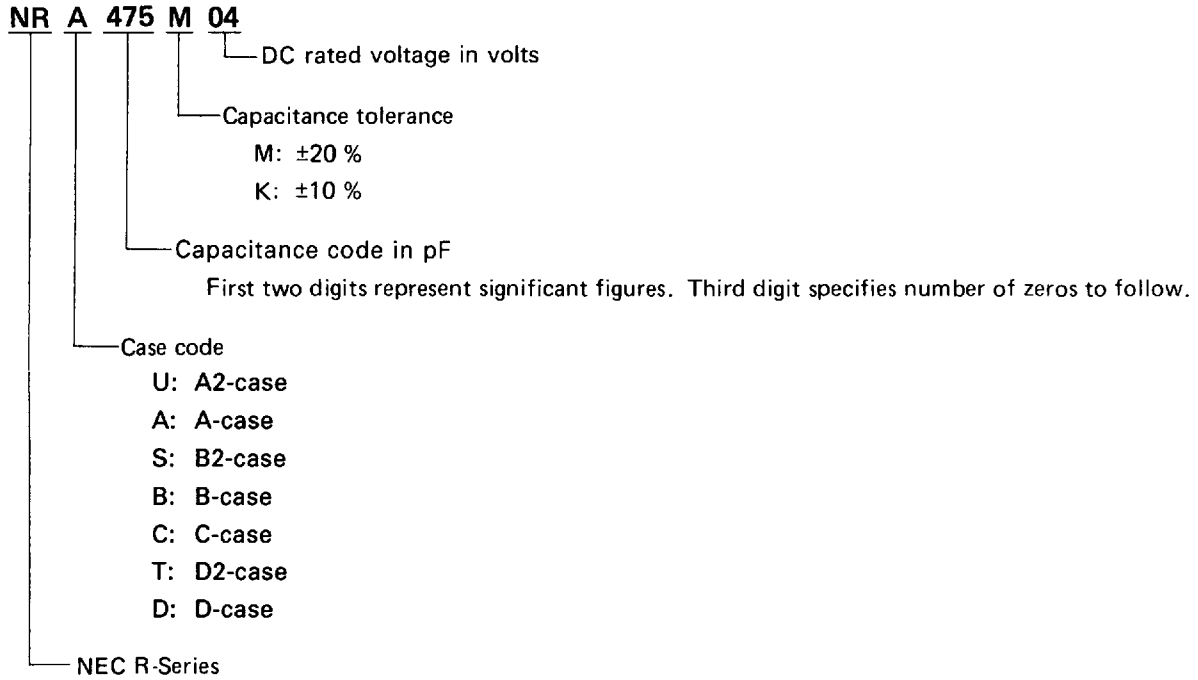

Tape and reel

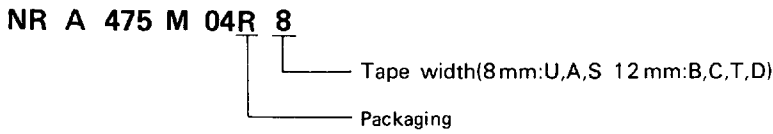

R: Reel diameter 178 mm (7 inch)

Orientation

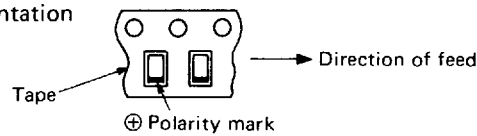

L: Reel diameter 178 mm (7 inch)

Orientation

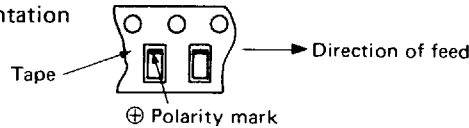

P: Reel diameter 330 mm (13 inch)

Orientation

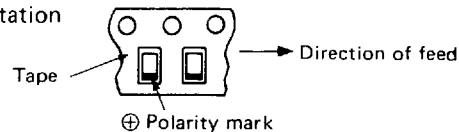

N: Reel diameter 330 mm (13 inch)

Orientation

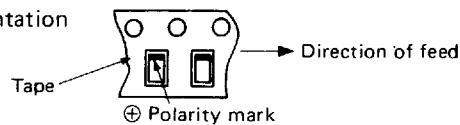

RATINGS AND PART NUMBER

Standard type

Rated voltage @85°C (125°C) Vdc	Capacitance @25°C, 120Hz μF	Part number	Case code	Leakage current @25°C μA max.	Dissipation factor @25°C, 120Hz % max.
50 (32)	0.1	NRA104M50	A	0.5	4
	0.15	NRA154M50	A	0.5	4
	0.22	NRS224M50	B2(S)	0.5	4
	0.33	NRS334M50	B2(S)	0.5	4
	0.47	NRS474M50	B2(S)	0.5	4
	0.68	NRC684M50	C	0.5	4
	1	NRC105M50	C	0.5	4
	1.5	NRC155M50	C	0.7	4
	2.2	NRD225M50	D	1.1	4
	3.3	NRT335M50	D2(T)	1.6	4
	3.3	NRD335M50	D	1.6	4
	4.7	NRD475M50	D	2.3	4
35 (22)	0.047	NRA473M35	A	0.5	4
	0.068	NRA683M35	A	0.5	4
	0.1	NRA104M35	A	0.5	4
	0.15	NRA154M35	A	0.5	4
	0.22	NRA224M35	A	0.5	4
	0.33	NRA334M35	A	0.5	4
	0.47	NRS474M35	B2(S)	0.5	4
	0.47	NRB474M35	B	0.5	4
	0.68	NRS684M35	B2(S)	0.5	4
	0.68	NRB684M35	B	0.5	4
	1	NRS105M35	B2(S)	0.5	4
	1	NRB105M35	B	0.5	4
	1.5	NRC155M35	C	0.5	4
	2.2	NRC225M35	C	0.7	4
	3.3	NRC335M35	C	1.2	4
	3.3	NRD335M35	D	1.2	4
	4.7	NRT475M35	D2(T)	1.6	4
	4.7	NRD475M35	D	1.6	4
6.8	NRT685M35	D2(T)	2.3	6	
6.8	NRD685M35	D	2.3	6	
25 (16)	0.47	NRA474M25	A	0.5	4
	1.5	NRS155M25	B2(S)	0.5	4
	1.5	NRB155M25	B	0.5	4
	3.3	NRC335M25	C	0.8	4
	4.7	NRC475M25	C	1.1	4
	6.8	NRT685M25	D2(T)	1.7	6
	6.8	NRD685M25	D	1.7	6
	10	NRT106M25	D2(T)	2.5	6
	10	NRD106M25	D	2.5	6
20 (13)	0.68	NRA684M20	A	0.5	4
	2.2	NRS225M20	B2(S)	0.5	4
	2.2	NRB225M20	B	0.5	4
	4.7	NRC475M20	C	0.9	4
	6.8	NRC685M20	C	1.4	6
	10	NRT106M20	D2(T)	2.0	6
	10	NRD106M20	D	2.0	6
	15	NRT156M20	D2(T)	3.0	6
15	NRD156M20	D	3.0	6	

Rated voltage @85°C (125°C) Vdc	Capacitance @25°C, 120Hz μF	Part number	Case code	Leakage current @25°C μA max.	Dissipation factor @25°C, 120Hz % max.
16 (10)	1	NRA105M16	A	0.5	4
	1.5	NRA155M16	A	0.5	4
	3.3	NRS335M16	B2(S)	0.5	4
	3.3	NRB335M16	B	0.5	4
	6.8	NRC685M16	C	1.0	6
	10	NRC106M16	C	1.6	6
	15	NRT156M16	D2(T)	2.4	6
	15	NRD156M16	D	2.4	6
	22	NRT226M16	D2(T)	3.5	6
	22	NRD226M16	D	3.5	6
10 (6.3)	1.5	NRA155M10	A	0.5	4
	2.2	NRA225M10	A	0.5	4
	4.7	NRS475M10	B2(S)	0.5	4
	4.7	NRB475M10	B	0.5	4
	10	NRC106M10	C	1.0	6
	15	NRC156M10	C	1.5	6
	22	NRT226M10	D2(T)	2.2	6
	22	NRD226M10	D	2.2	6
	33	NRT336M10	D2(T)	3.3	6
	33	NRD336M10	D	3.3	6
6.3 (4)	2.2	NRA225M06	A	0.5	4
	3.3	NRA335M06	A	0.5	4
	6.8	NRS685M06	B2(S)	0.5	6
	6.8	NRB685M06	B	0.5	6
	15	NRC156M06	C	0.9	6
	22	NRC226M06	C	1.4	6
	33	NRT336M06	D2(T)	2.0	6
	33	NRD336M06	D	2.0	6
	47	NRT476M06	D2(T)	3.0	6
	47	NRD476M06	D	3.0	6
4 (2.5)	3.3	NRA335M04	A	0.5	4
	4.7	NRA475M04	A	0.5	4
	10	NRS106M04	B2(S)	0.5	6
	10	NRB106M04	B	0.5	6
	22	NRC226M04	C	0.8	6
	33	NRC336M04	C	1.3	6
	47	NRT476M04	D2(T)	1.9	6
	47	NRD476M04	D	1.9	6
	68	NRT686M04	D2(T)	2.7	6
	68	NRD686M04	D	2.7	6

Extended type

Rated voltage @85°C (125°C) Vdc	Capacitance @25°C, 120Hz μF	Part number	Case code	Leakage current @25°C μA max.	Dissipation factor @25°C, 120Hz % max.
35 (22)	0.47	NRA474M35	A	0.5	6
	0.68	NRA684M35	A	0.5	6
	1	NRA105M35	A	0.5	6
	1.5	NRA155M35	A	0.5	6
	1.5	NRS155M35	B2(S)	0.5	6
	1.5	NRB155M35	B	0.5	6
	2.2	NRS225M35	B2(S)	0.7	6
	2.2	NRB225M35	B	0.7	6
	3.3	NRS335M35	B2(S)	1.1	6
	4.7	NRC475M35	C	1.6	6
	6.8	NRC685M35	C	2.3	6
	10	NRD106M35	D	3.5	6
	15	NRD156M35	D	5.2	6
25 (16)	1	NRA105M25	A	0.5	6
	1.5	NRA155M25	A	0.5	6
	2.2	NRA225M25	A	0.5	6
	2.2	NRS225M25	B2(S)	0.5	6
	3.3	NRS335M25	B2(S)	0.8	6
	3.3	NRB335M25	B	0.8	6
	4.7	NRS475M25	B2(S)	1.1	6
	6.8	NRC685M25	C	1.7	6
	10	NRC106M25	C	2.5	6
	15	NRD156M25	D	3.7	6
22	NRD226M25	D	5.5	6	
20 (13)	0.1	NRU104M20	A2(U)	0.5	6
	0.15	NRU154M20	A2(U)	0.5	6
	0.22	NRU224M20	A2(U)	0.5	6
	0.33	NRU334M20	A2(U)	0.5	6
	0.47	NRU474M20	A2(U)	0.5	6
	0.68	NRU684M20	A2(U)	0.5	6
	1	NRU105M20	A2(U)	0.5	6
	1.5	NRU155M20	A2(U)	0.5	6
	1.5	NRA155M20	A	0.5	6
	2.2	NRA225M20	A	0.5	6
	3.3	NRA335M20	A	0.6	6
	3.3	NRS335M20	B2(S)	0.6	6
	4.7	NRS475M20	B2(S)	0.9	6
	4.7	NRB475M20	B	0.9	6
	6.8	NRS685M20	B2(S)	1.4	6
	10	NRS106M20	B2(S)	2.0	6
	10	NRC106M20	C	2.0	6
	15	NRC156M20	C	3.0	6
	22	NRC226M20	C	4.4	6
	22	NRT226M20	D2(T)	4.4	6
22	NRD226M20	D	4.4	6	
33	NRT336M20	D2(T)	6.6	6	
33	NRD336M20	D	6.6	6	
47	NRD476M20	D	9.4	6	
16 (10)	0.68	NRU684M16	A2(U)	0.5	6
	1	NRU105M16	A2(U)	0.5	6
	1.5	NRU155M16	A2(U)	0.5	6
	2.2	NRU225M16	A2(U)	0.5	6
	2.2	NRA225M16	A	0.5	6
	3.3	NRA335M16	A	0.5	6
4.7	NRA475M16	A	0.7	6	

Rated voltage @85°C (125°C) Vdc	Capacitance @25°C, 120Hz μF	Part number	Case code	Leakage current @25°C μA max.	Dissipation factor @25°C, 120Hz % max.
16 (10)	4.7	NRS475M16	B2(S)	0.7	6
	6.8	NRS685M16	B2(S)	1.0	6
	6.8	NRB685M16	B	1.0	6
	10	NRS106M16	B2(S)	1.6	6
	15	NRS156M16	B2(S)	2.4	6
	15	NRC156M16	C	2.4	6
	22	NRC226M16	C	3.5	6
	33	NRC336M16	C	5.2	6
	33	NRT336M16	D2(T)	5.2	6
	33	NRD336M16	D	5.2	6
	47	NRT476M16	D2(T)	7.5	6
	47	NRD476M16	D	7.5	6
	68	NRD686M16	D	10.8	6
10 (6.3)	1	NRU105M10	A2(U)	0.5	8
	1.5	NRU155M10	A2(U)	0.5	8
	2.2	NRU225M10	A2(U)	0.5	8
	3.3	NRU335M10	A2(U)	0.5	8
	3.3	NRA335M10	A	0.5	8
	4.7	NRA475M10	A	0.5	8
	6.8	NRA685M10	A	0.6	8
	6.8	NRS685M10	B2(S)	0.6	8
	10	NRA106M10	A	1.0	8
	10	NRS106M10	B2(S)	1.0	8
	10	NRB106M10	B	1.0	8
	15	NRS156M10	B2(S)	1.5	8
	22	NRS226M10	B2(S)	2.2	8
	22	NRC226M10	C	2.2	8
	33	NRS336M10	B2(S)	3.3	8
	33	NRC336M10	C	3.3	8
	47	NRC476M10	C	4.7	8
	47	NRT476M10	D2(T)	4.7	8
	47	NRD476M10	D	4.7	8
	68	NRC686M10	C	6.8	8
68	NRT686M10	D2(T)	6.8	8	
68	NRD686M10	D	6.8	8	
100	NRD107M10	D	10	8	
6.3 (4)	1.5	NRU155M06	A2(U)	0.5	8
	2.2	NRU225M06	A2(U)	0.5	8
	3.3	NRU335M06	A2(U)	0.5	8
	4.7	NRU475M06	A2(U)	0.5	8
	4.7	NRA475M06	A	0.5	8
	6.8	NRU685M06	A2(U)	0.5	8
	6.8	NRA685M06	A	0.5	8
	10	NRA106M06	A	0.6	8
	10	NRS106M06	B2(S)	0.6	8
	15	NRA156M06	A	0.9	8
	15	NRS156M06	B2(S)	0.9	8
	15	NRB156M06	B	0.9	8
	22	NRS226M06	B2(S)	1.4	8
	33	NRS336M06	B2(S)	2.0	8
	33	NRC336M06	C	2.0	8
	47	NRS476M06	B2(S)	3.0	8
	47	NRC476M06	C	3.0	8
	68	NRC686M06	C	4.2	8
	68	NRT686M06	D2(T)	4.2	8
	68	NRD686M06	D	4.2	8
100	NRC107M06	C	6.3	10	
100	NRT107M06	D2(T)	6.3	8	
100	NRD107M06	D	6.3	8	
150	NRD157M06	D	9.4	8	

Rated voltage @85°C (125°C) Vdc	Capacitance @25°C, 120Hz μF	Part number	Case code	Leakage current @25°C μA max.	Dissipation factor @25°C, 120Hz % max.
4 (2.5)	2.2	NRU225M04	A2(U)	0.5	8
	3.3	NRU335M04	A2(U)	0.5	8
	4.7	NRU475M04	A2(U)	0.5	8
	6.8	NRU685M04	A2(U)	0.5	8
	6.8	NRA685M04	A	0.5	8
	10	NRU106M04	A2(U)	0.5	12
	10	NRA106M04	A	0.5	8
	15	NRA156M04	A	0.6	8
	15	NRS156M04	B2(S)	0.6	8
	22	NRA226M04	A	0.8	8
	22	NRS226M04	B2(S)	0.8	8
	22	NRB226M04	B	0.8	8
	33	NRS336M04	B2(S)	1.3	8
	47	NRS476M04	B2(S)	1.8	8
	47	NRC476M04	C	1.8	8
	68	NRC686M04	C	2.7	8
	100	NRC107M04	C	4.0	8
	100	NRT107M04	D2(T)	4.0	8
	100	NRD107M04	D	4.0	8
	150	NRC157M04	C	6.0	10
150	NRD157M04	D	6.0	8	
150	NRT157M04	D2(T)	6.0	8	
220	NRD227M04	D	8.8	8	
2.5 (1.6)	4.7	NRU475M02	A2(U)	0.5	8
	6.8	NRU685M02	A2(U)	0.5	8
	10	NRU106M02	A2(U)	0.5	8
	15	NRU156M02	A2(U)	0.5	12
	15	NRA156M02	A	0.5	8
	22	NRA226M02	A	0.5	8
	33	NRA336M02	A	0.8	8
	33	NRS336M02	B2(S)	0.8	8
	47	NRS476M02	B2(S)	1.1	8
	68	NRS686M02	B2(S)	1.7	8

NOTE

Part numbers in the tables above are for products with a capacitance tolerance of ± 20 %. For products with a capacitance tolerance of ± 10 %, change the letter M to K. Use the letters U, S, and T in part numbers for the case codes A2, B2, and D2.

• R series (standard)

High and low temperature stability

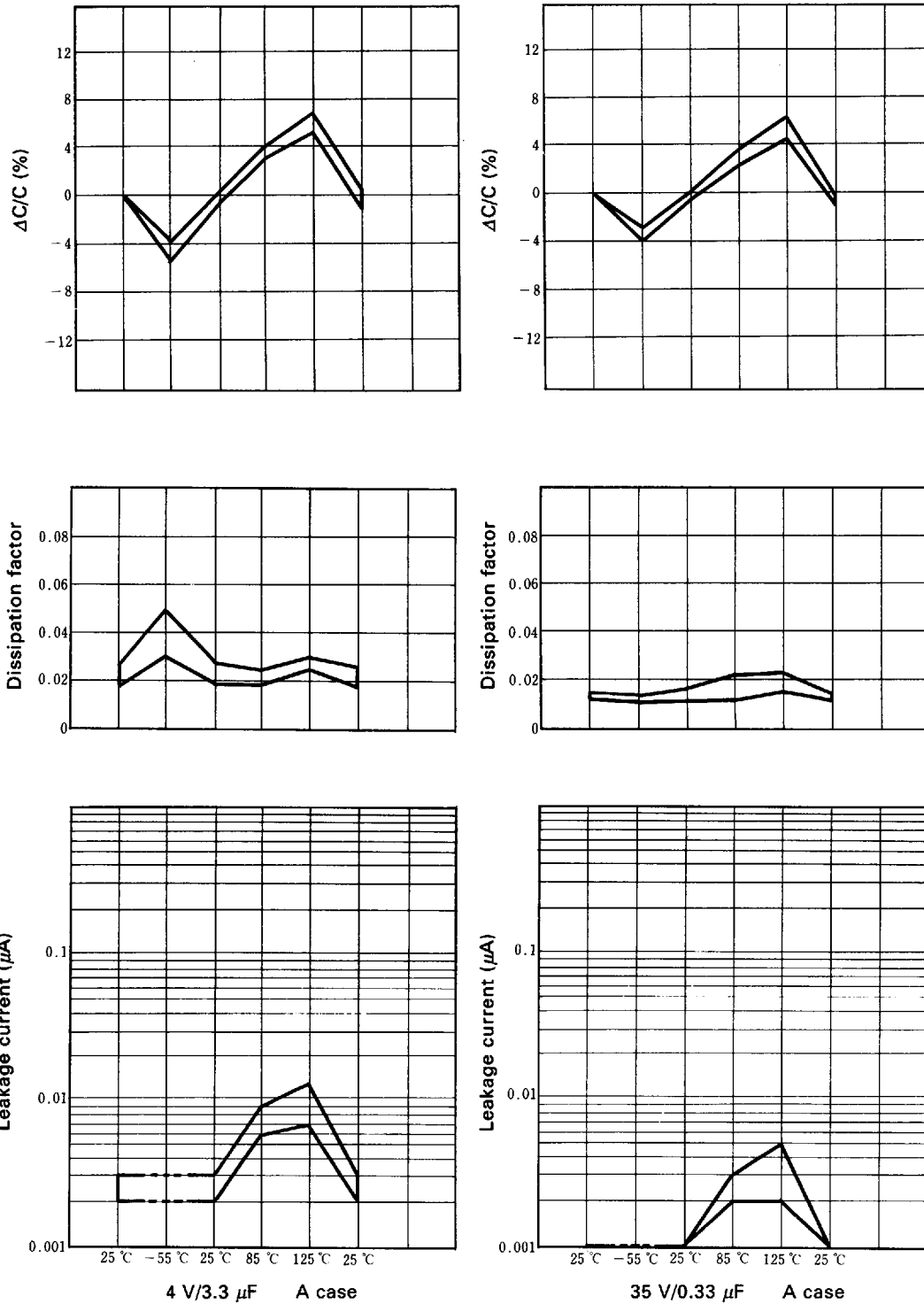

• R series (standard)

High and low temperature stability

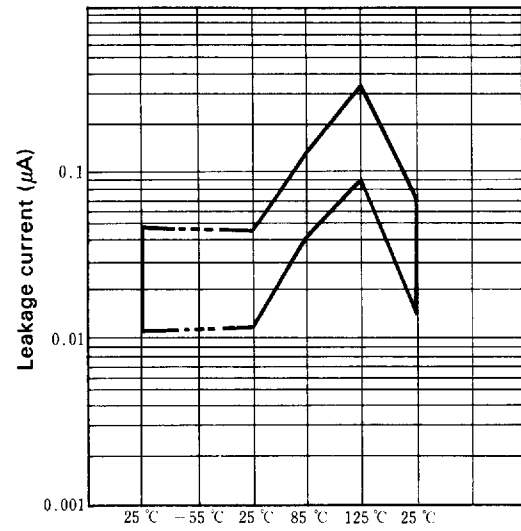
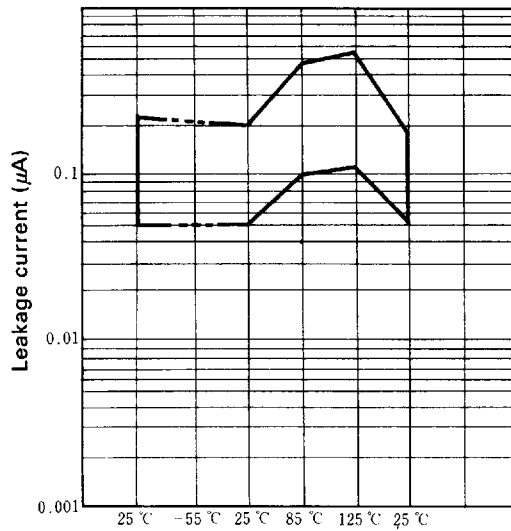
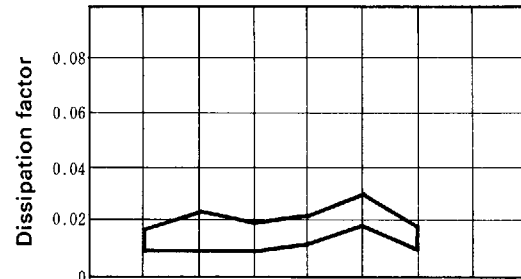
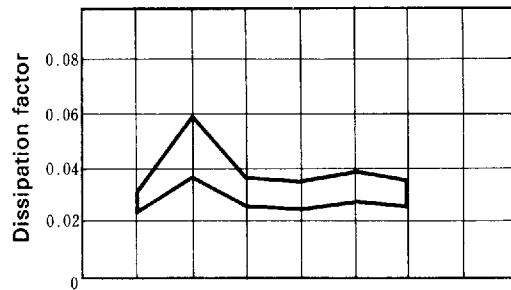
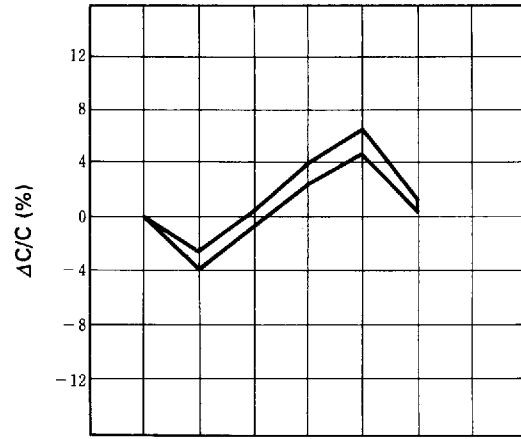
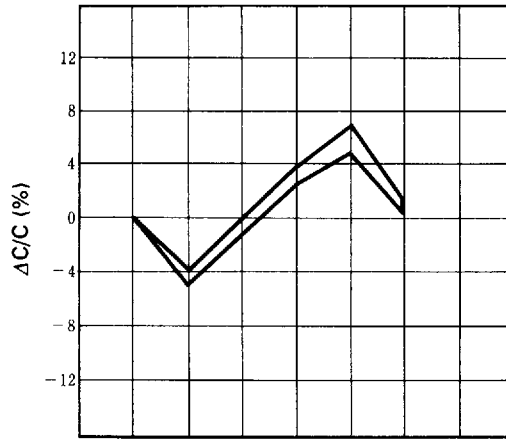

4 V/68 μF D case

35 V/6.8 μF D case

• R series (standard)

Soldering heat resistance (immersing for 10 sec. at 260 °C)

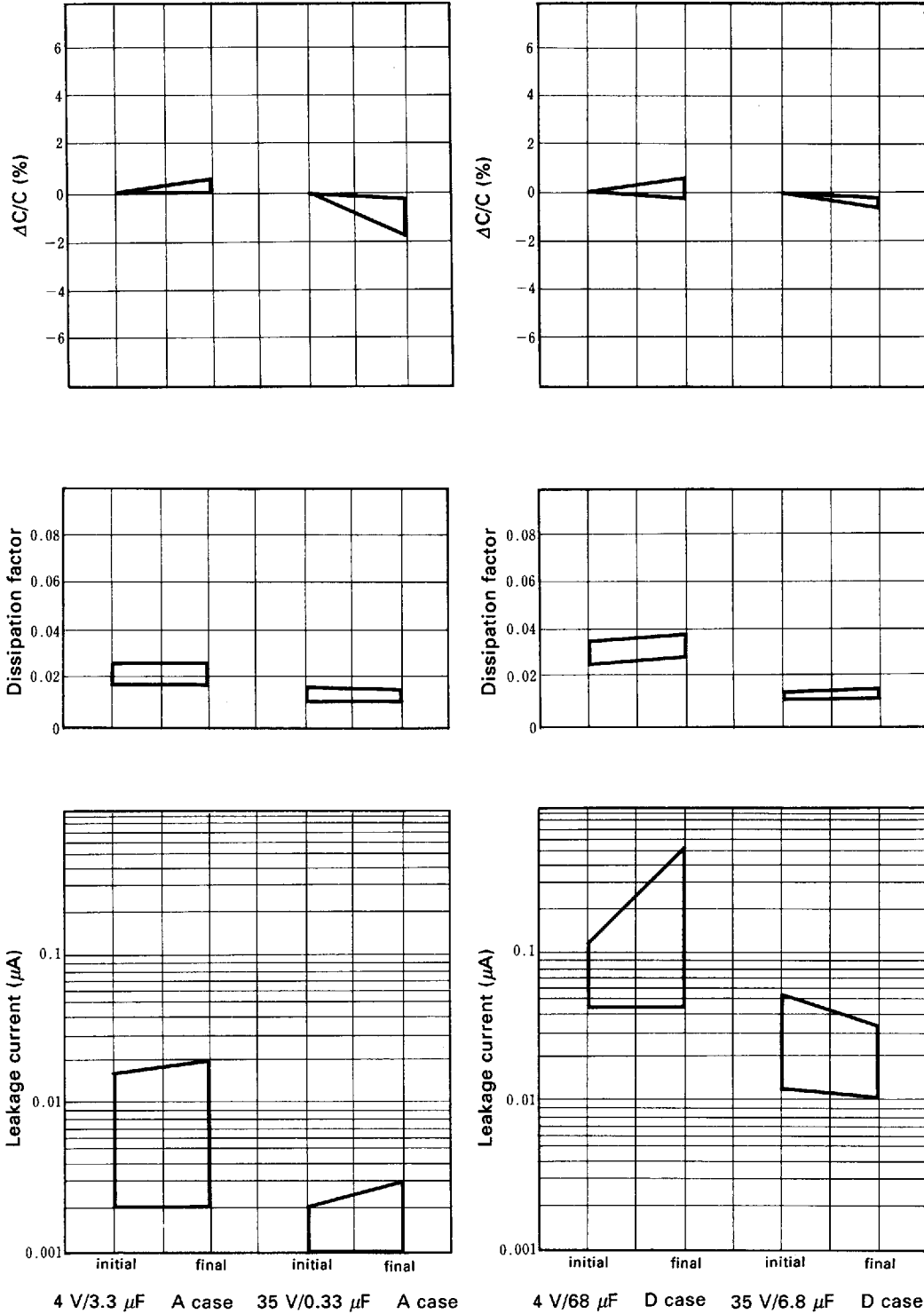

• R series (standard)

Humidity test (40°C, 90~95%RH)

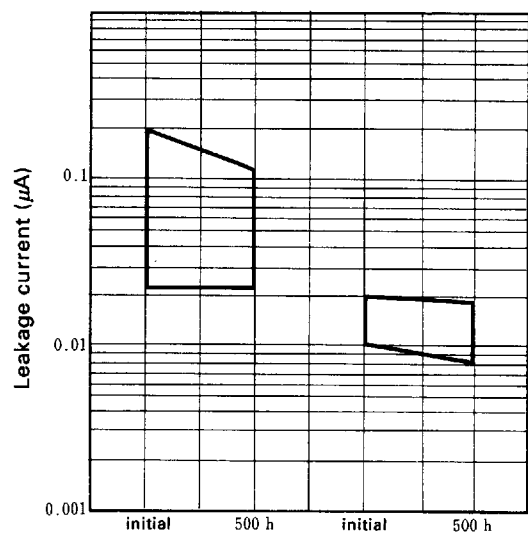
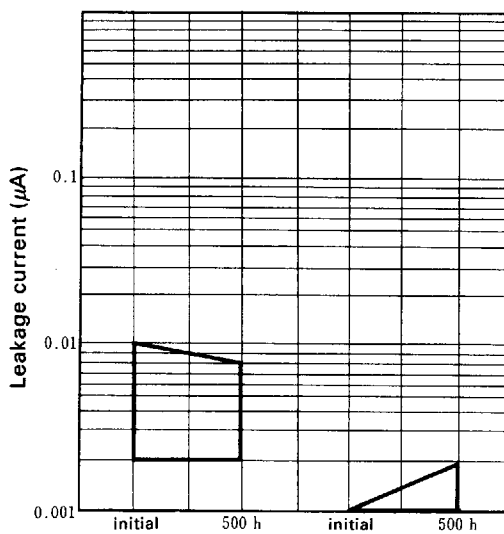
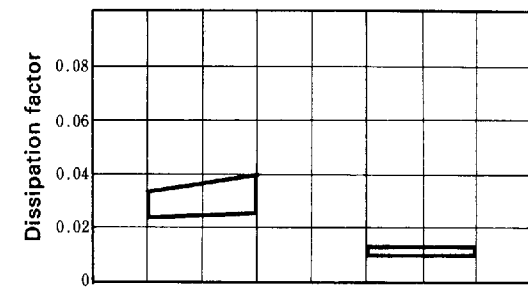
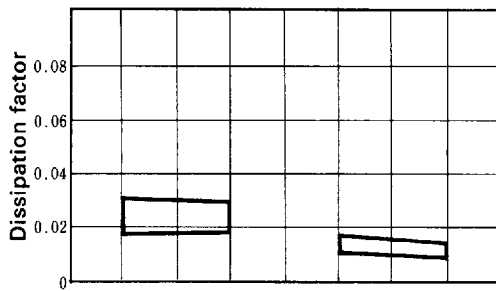
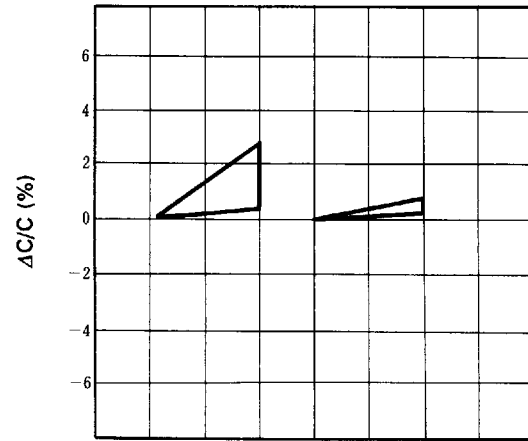
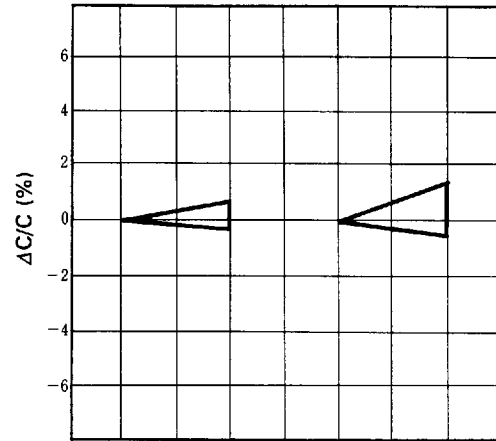

4 V/3.3 μ F A case 35 V/0.33 μ F A case

4 V/68 μ F D case 35 V/6.8 μ F D case

• R series (standard)

Load life (85 °C, rated voltage applied)

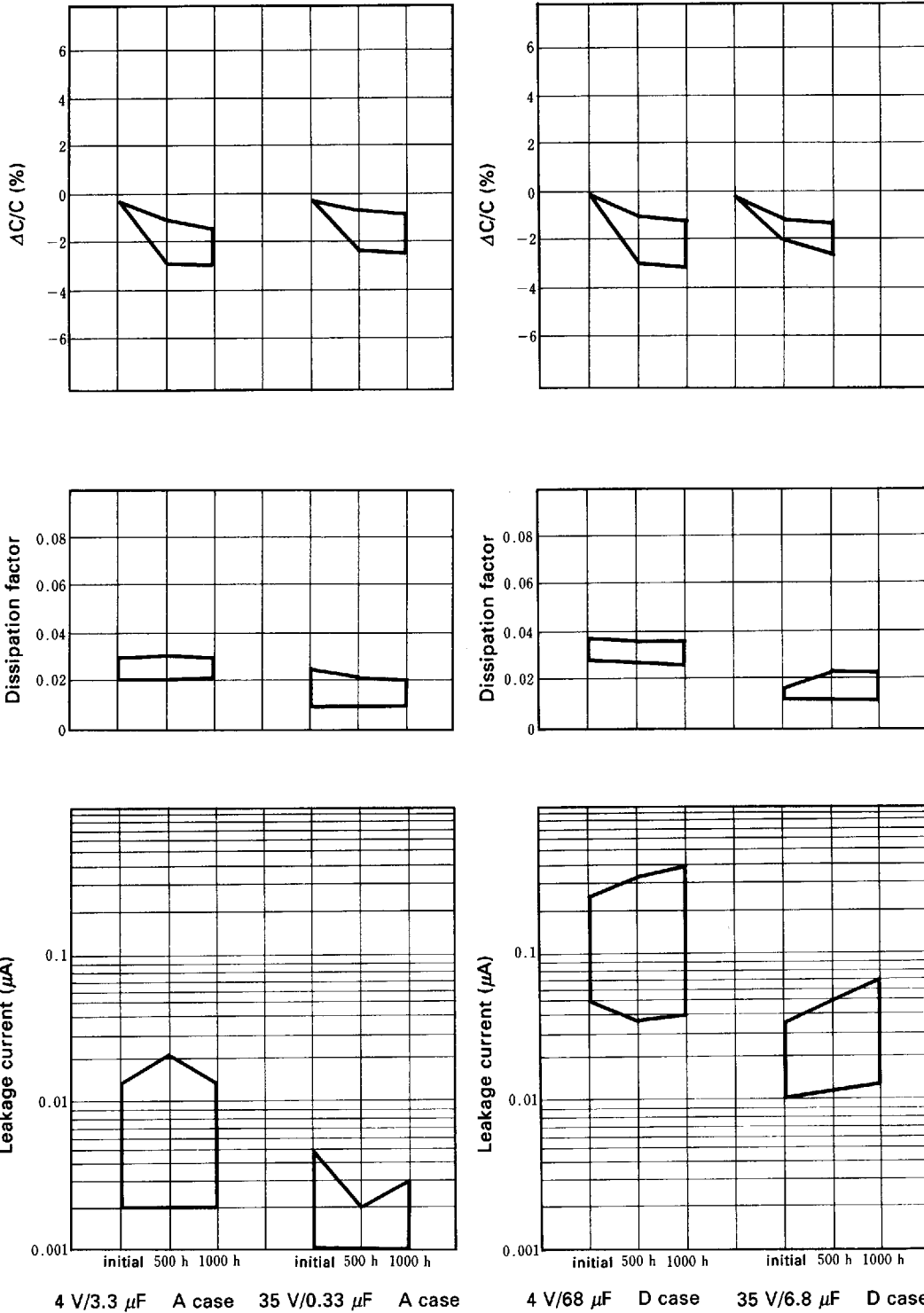

• R series (Extended)

High and low temperature stability

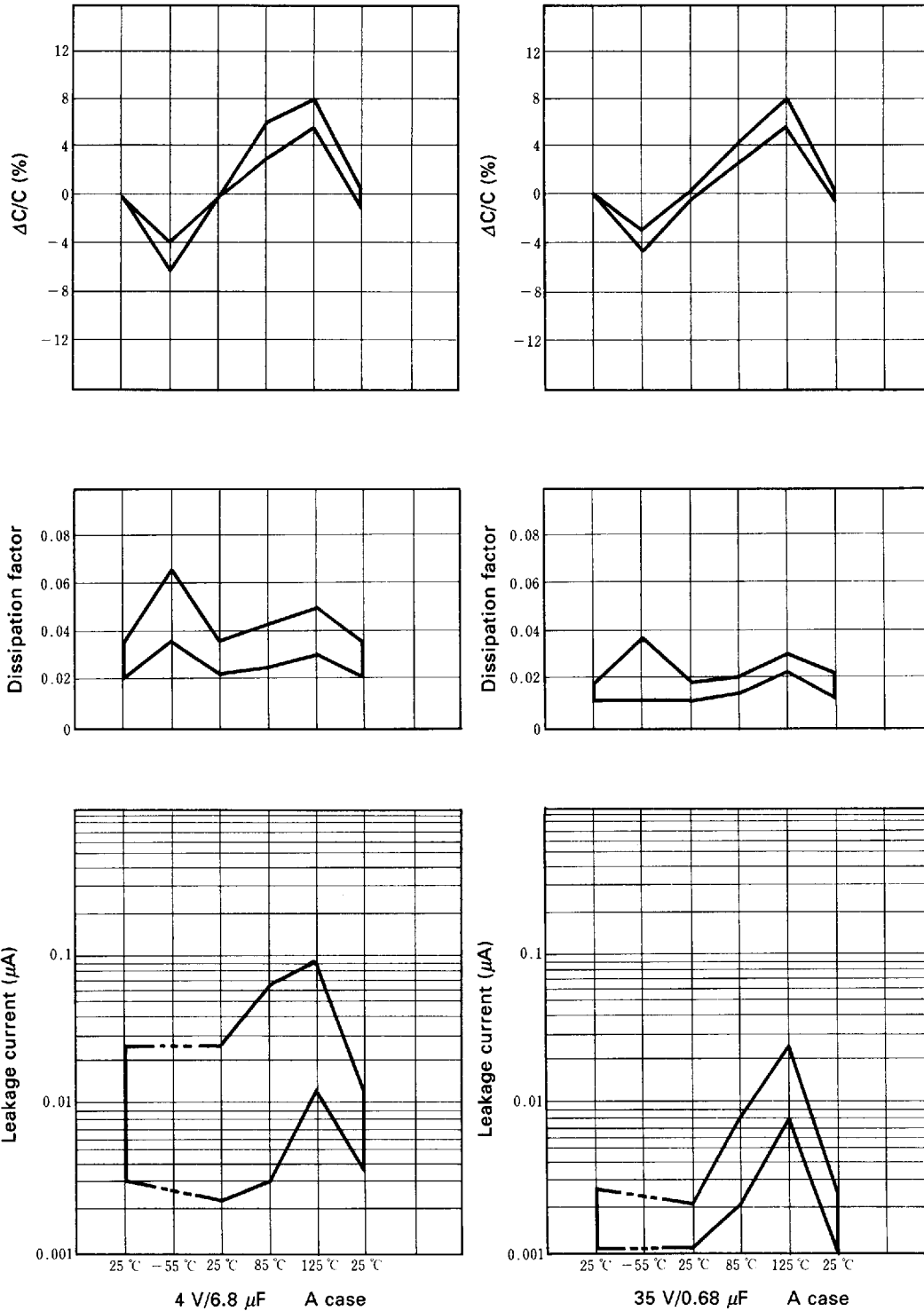

• R series (Extended)

High and low temperature stability

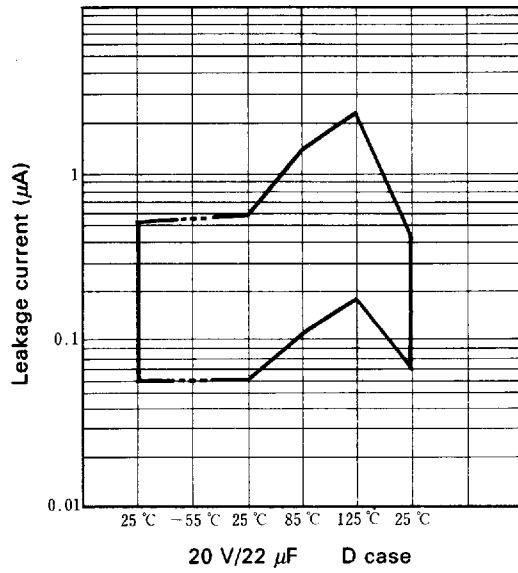
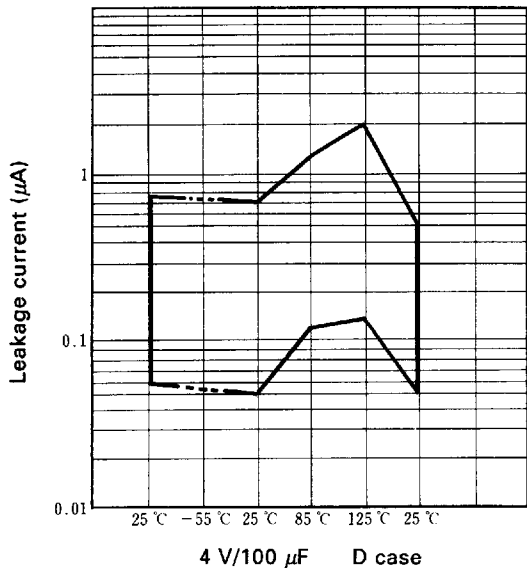
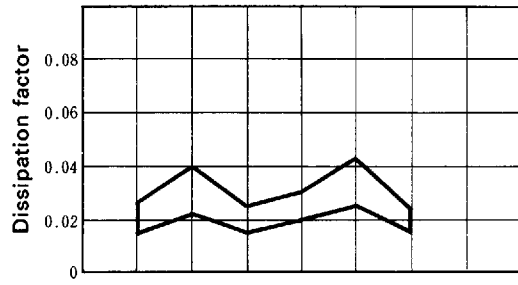
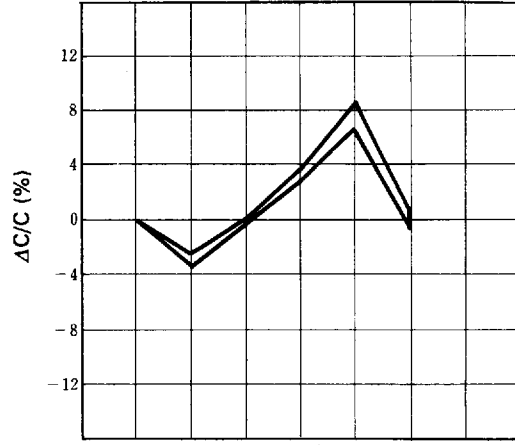
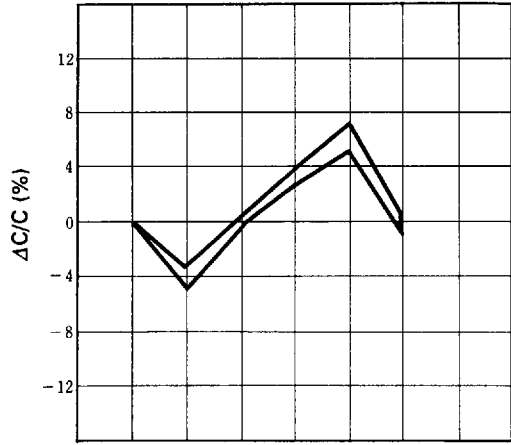

• R series (Extended)

Solder heat resistance (immersing for 10 sec. at 260 °C)

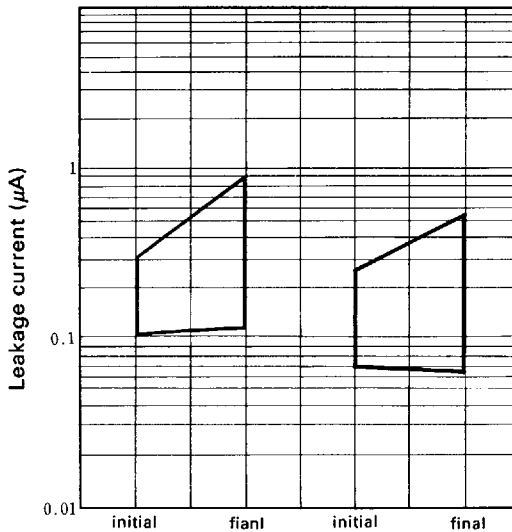
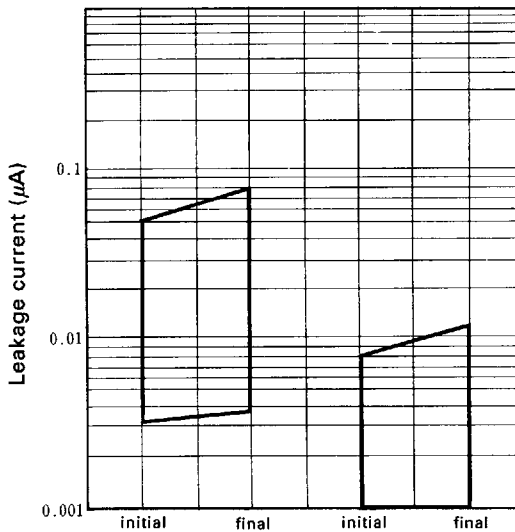
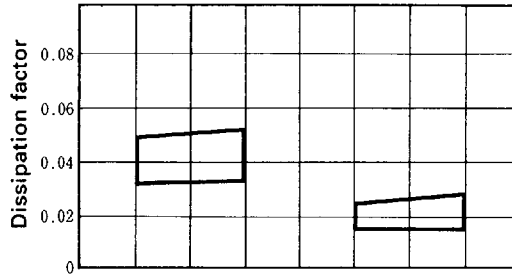
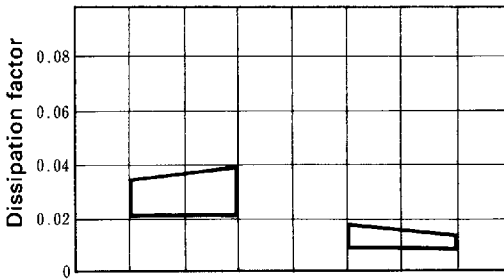
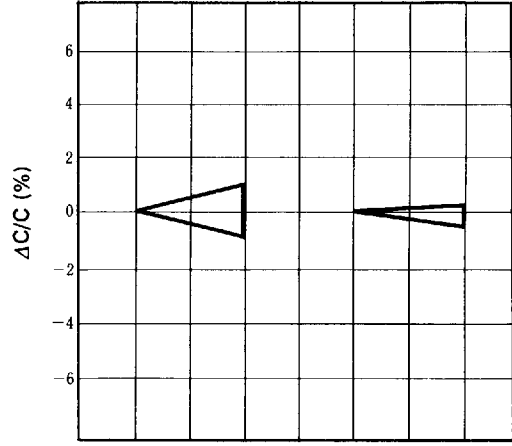
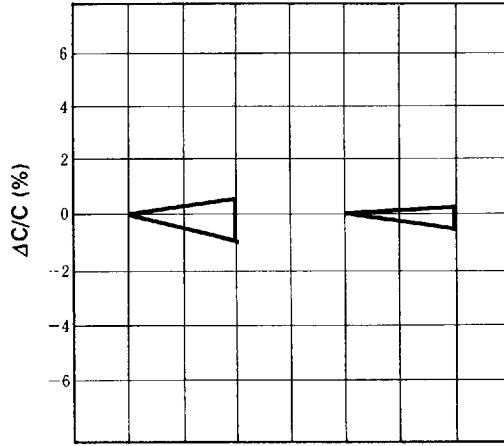

4 V/6.8 μF A case 35 V/0.68 μF A case

4 V/100 μF D case 20 V/22 μF D case

• R series (Extended)

Humidity test (40 °C, 90 to 95% RH)

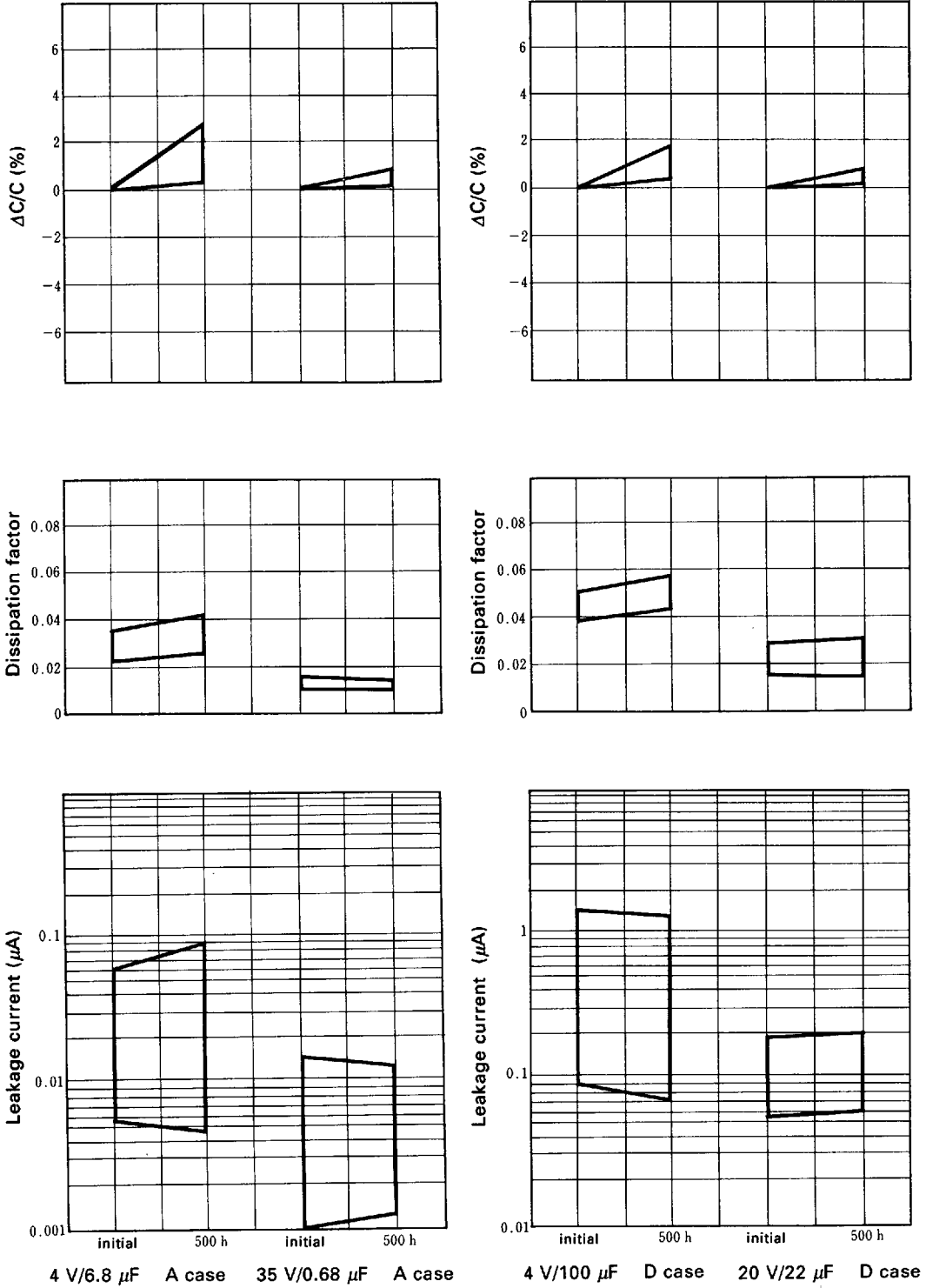

• R series (Extended)

Load life (85°C, rated voltage applied)

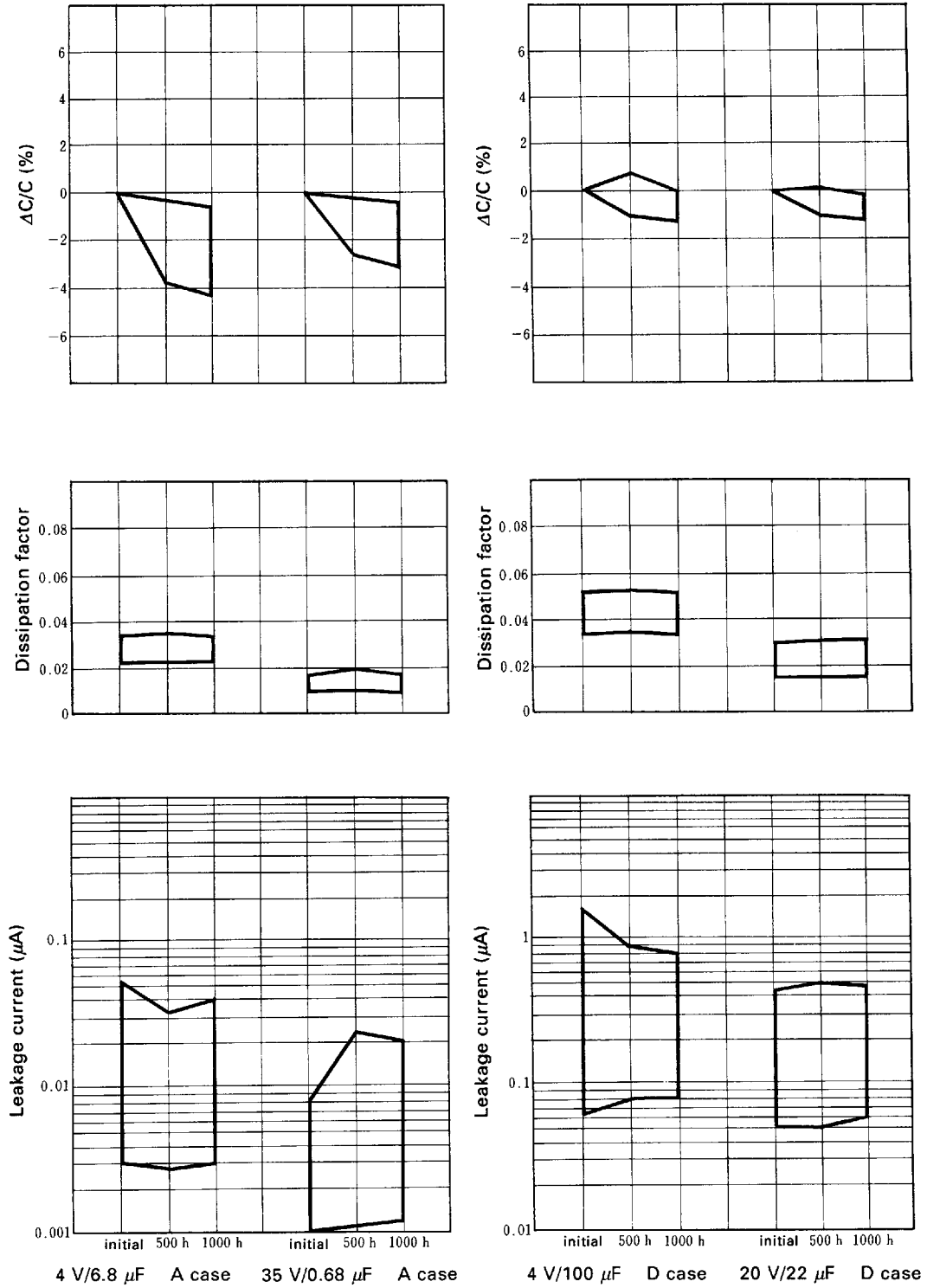

R series (standard)

• Frequency characteristics

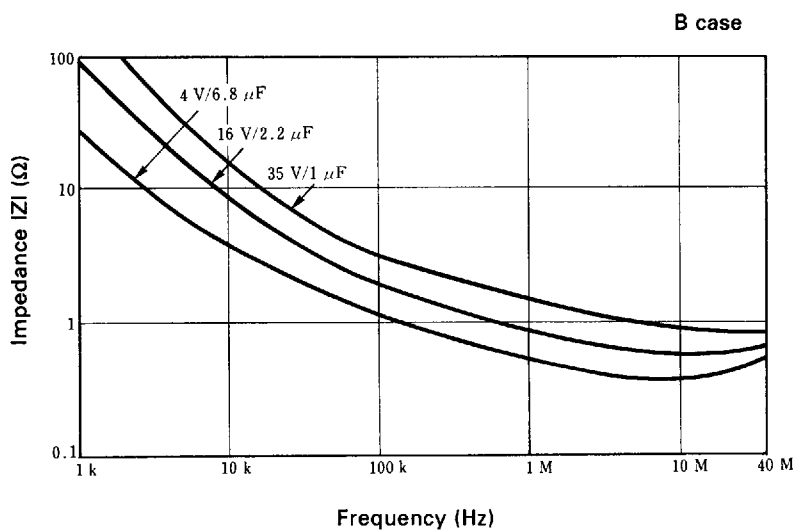
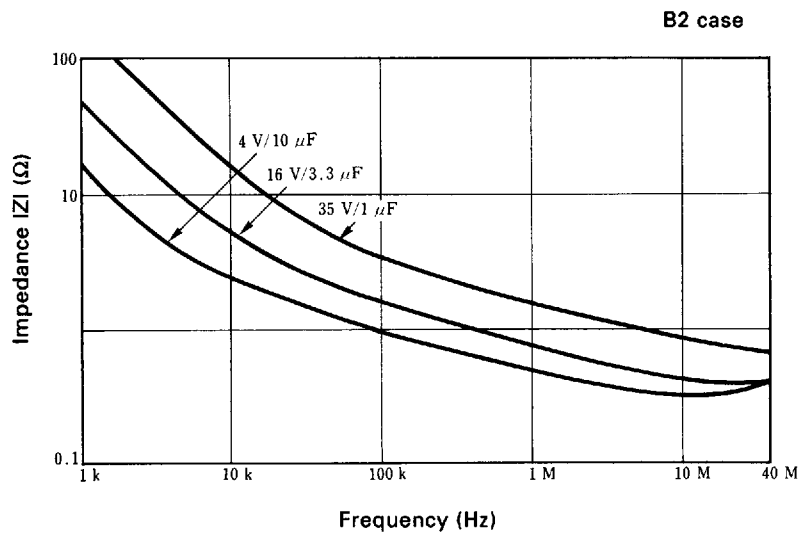
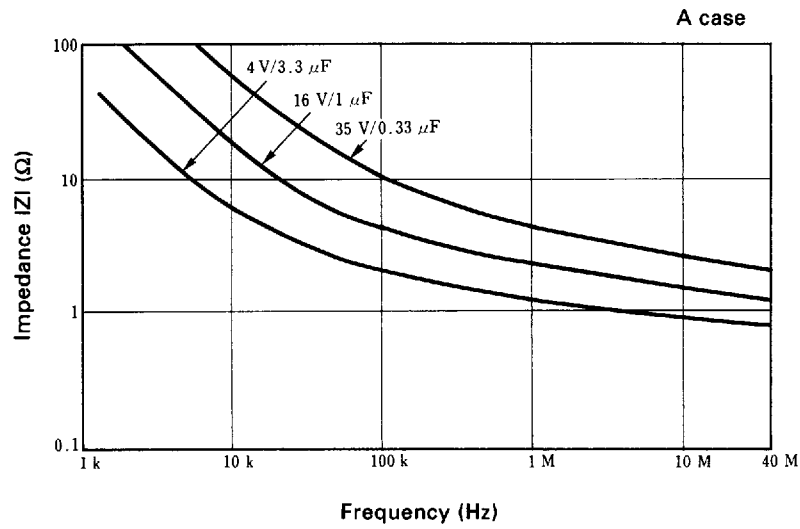

R series (standard)

- Frequency characteristics

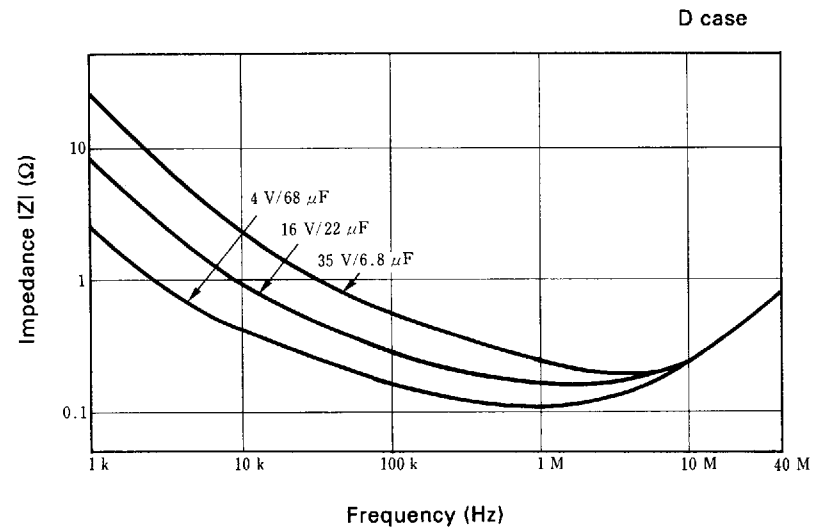
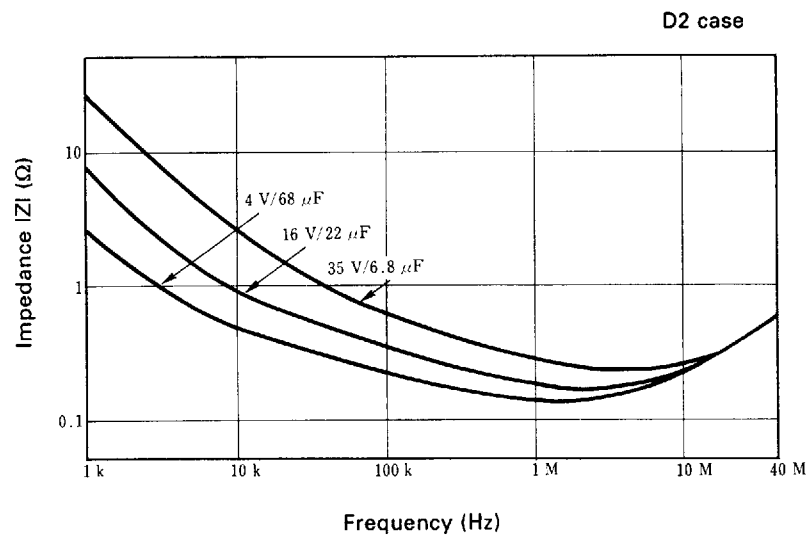
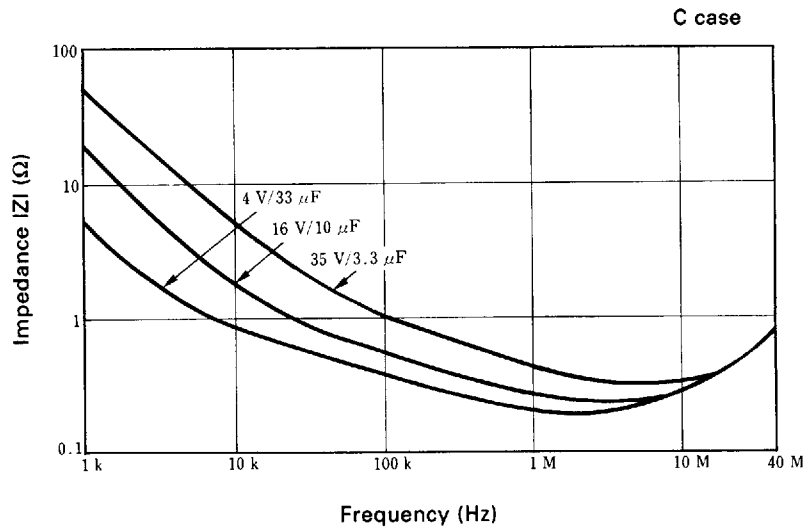

■ TAPE AND REEL SPECIFICATIONS

Plastic tape carrier

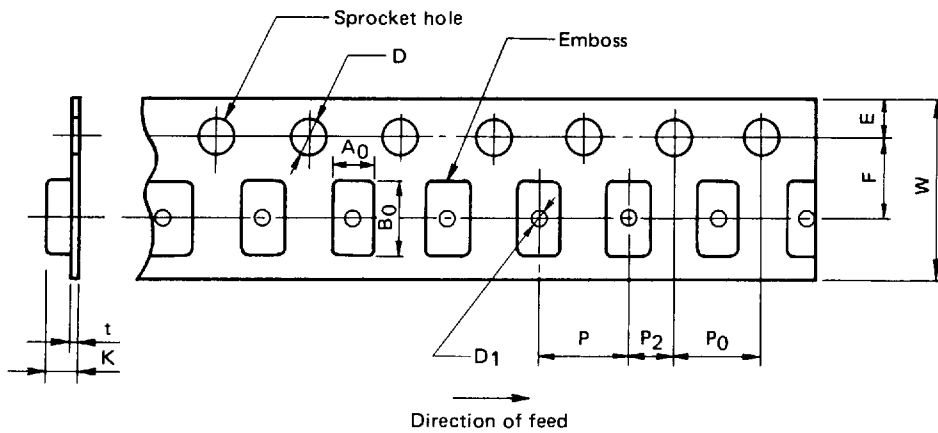

Unit: mm (inch)

Case code	W±0.3 (±0.012)	F±0.1 (±0.004)	E±0.1 (±0.004)	P±0.1 (±0.004)	P ₂ ±0.1 (±0.004)	P ₀ ±0.1 (±0.004)	D ^{+0.1} / ₀ (+0.004) 0	D ₁ min.	t	A ₀ ±0.2 (±0.008)	B ₀ ±0.2 (±0.008)	K±0.2 (±0.008)
A2 (U)	8 (0.315)	3.5 (0.138)	1.75 (0.069)	4 (0.157)	2 (0.079)	4 (0.157)	φ1.5 (0.059)	φ1.0 (0.039)	0.2 (0.008)	1.9 (0.075)	3.5 (0.138)	1.4 (0.055)
A										3.3 (0.130)	3.8 (0.150)	1.9 (0.075)
B2 (S)										3.1 (0.122)	5.1 (0.201)	2.6 (0.102)
B	12 (0.472)	5.5 (0.217)	1.75 (0.069)	8 (0.315)	2 (0.079)	4 (0.157)	φ1.5 (0.059)	φ1.5 (0.059)	0.3 (0.012)	3.7 (0.146)	6.4 (0.252)	3.0 (0.118)
C									5.1 (0.201)	6.2 (0.244)	3.6 (0.142)	
D2 (T)									0.4 (0.016)	4.8 (0.189)	7.7 (0.303)	3.3 (0.130)
D									0.3 (0.012)	4.8 (0.189)	7.7 (0.303)	3.3 (0.130)

Leader and trailer

Unit: mm (inch)

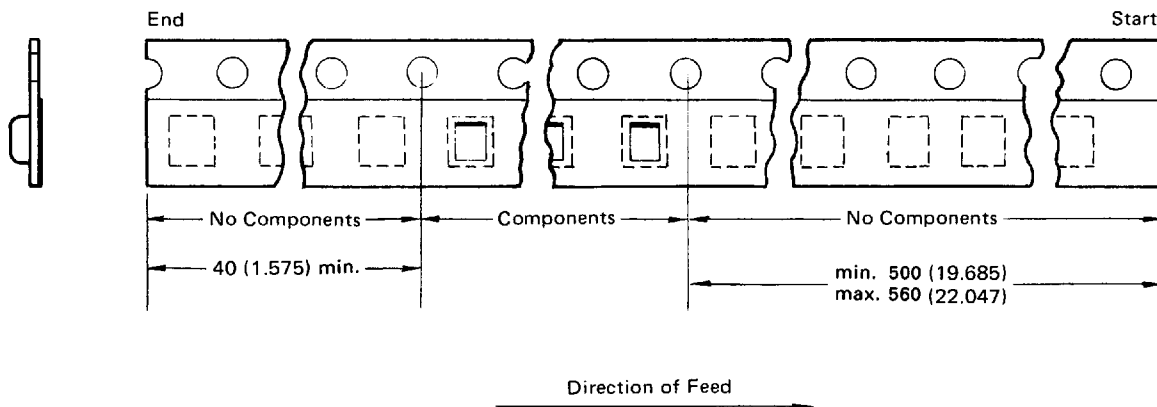

Reel

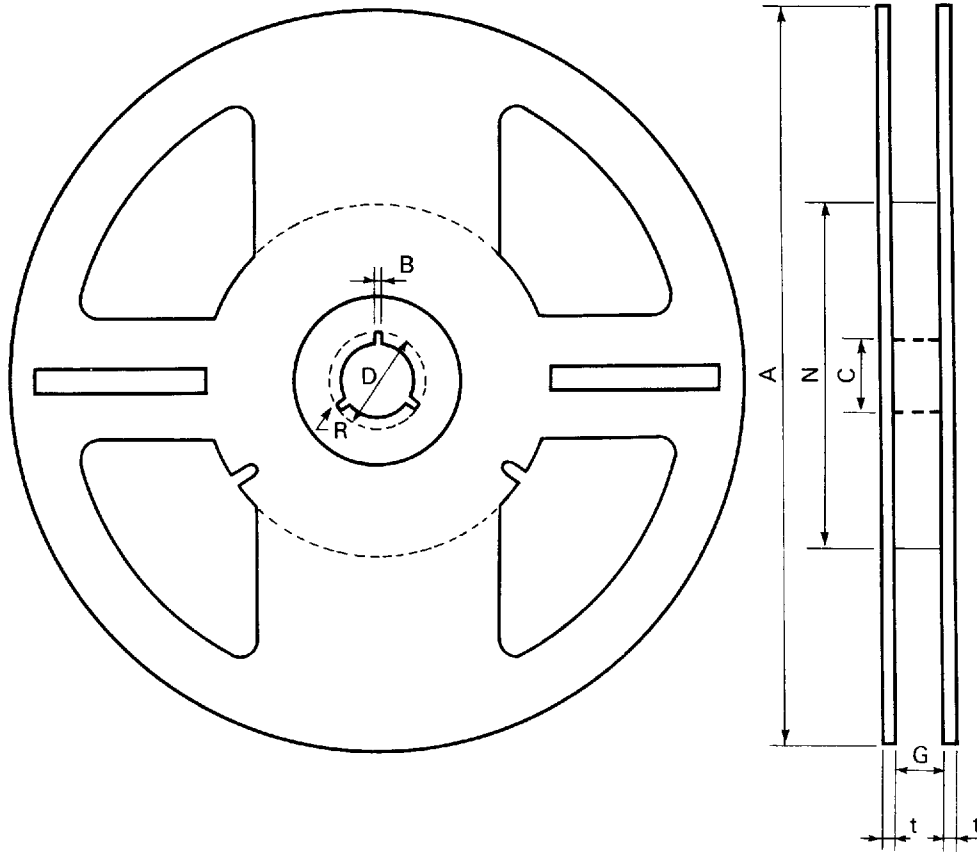

Unit: mm (inch)

Tape width	A±2 (±0.079)	N min.	C±0.5 (±0.020)	D±0.5 (±0.020)	B±0.5 (±0.020)	G±1.5 (±0.059)	t±0.5 (±0.020)	R
8 mm	φ178 (7)	φ50 (1.969)	φ13 (0.512)	φ21 (0.827)	2 (0.079)	10 (0.394)	2 (0.079)	1 (0.039)
12 mm						14 (0.551)		
8 mm	φ330 (13)	φ80 (3.150)	φ13 (0.512)	φ21 (0.827)	2 (0.079)	10 (0.394)	2 (0.079)	1 (0.039)
12 mm						14 (0.551)		

Case code	Dia. 178 mm	Dia. 330 mm
A2 (U)	3000	15000
A	2000	10000
B2 (S)	2000	5000
B	1500	5000
C, D2 (T), D	500	2500

[QUANTITY PER REEL]



Стандарт Электрон Связь

Мы молодая и активно развивающаяся компания в области поставок электронных компонентов. Мы поставляем электронные компоненты отечественного и импортного производства напрямую от производителей и с крупнейших складов мира.

Благодаря сотрудничеству с мировыми поставщиками мы осуществляем комплексные и плановые поставки широчайшего спектра электронных компонентов.

Собственная эффективная логистика и склад в обеспечивает надежную поставку продукции в точно указанные сроки по всей России.

Мы осуществляем техническую поддержку нашим клиентам и предпродажную проверку качества продукции. На все поставляемые продукты мы предоставляем гарантию .

Осуществляем поставки продукции под контролем ВП МО РФ на предприятия военно-промышленного комплекса России , а также работаем в рамках 275 ФЗ с открытием отдельных счетов в уполномоченном банке. Система менеджмента качества компании соответствует требованиям ГОСТ ISO 9001.

Минимальные сроки поставки, гибкие цены, неограниченный ассортимент и индивидуальный подход к клиентам являются основой для выстраивания долгосрочного и эффективного сотрудничества с предприятиями радиоэлектронной промышленности, предприятиями ВПК и научно-исследовательскими институтами России.

С нами вы становитесь еще успешнее!

Наши контакты:

Телефон: +7 812 627 14 35

Электронная почта: sales@st-electron.ru

Адрес: 198099, Санкт-Петербург,
Промышленная ул, дом № 19, литера Н,
помещение 100-Н Офис 331