

R-SERIES

FEATURES

- **High-temperature durability**

No solder is used in connecting the cathode terminal to the tantalum pellet. Consequently, users can apply direct soldering (wave soldering) and reflow soldering.

- **High adaptability of automatic assembly**

Tape and reel packaging is available in all product lines.

Precise dimensions due to transfer molded encapsulation provides excellent adaptability to automatic placement machines. Eight-millimeter-wide carrier tape packaging, which is used extensively in most machines, is available for capacitors up to 68 μ F (B2-Case).

The A-Case has the same dimensions (3.2 mm \times 1.6 mm) as chip resistors and ceramic capacitors.

The A2 Case has the same dimensions (3.2 mm \times 1.6 mm \times 1.2 mm MAX.) as mini mold Tr.

- **Wide operating temperature range**

The R-Series operating temperature range is -55°C to $+125^{\circ}\text{C}$.

- **IEC qualification approval**

The R-Series* is granted IEC (International Electrotechnical Commission) Qualification Approval in accordance with IEC Quality Assessment System for Electronic Components. * Except for 50-V items and R series Extended type.

Approval number JP154-9, JP154-10, JP154-11

Date of approval September 29, 1987

Detail specification IEC Pub. 384-3-1 JP0001 (QC300801 JP0001)

SPECIFICATIONS

No.	Item	Specification										Test method	
1	Operating temp. range	-55 to +125 °C											
2	Rated voltage	2.5	4	6.3	10	16	20	25	35	50	V.DC		
3	Surge voltage	3.3	5.2	8	13	20	26	33	46	65	V.DC	at 85°C	
4	Derated voltage	1.6	2.5	4	6.3	10	13	16	22	32	V.DC	at 125 °C	
5	Capacitance range	0.047 to 220 μ F										at 120 Hz	
6	Capacitance tolerance	± 20 % (± 10 %)										at 120 Hz	
7	Leakage current	0.01 CV (μ A) or 0.5 μ A whichever is greater										5 min, after rated voltage applied	
8	Dissipation factor	Standard	0.047 to 4.7 μ F : 0.04 max. 6.8 to 68 μ F : 0.06 max.									at 25 °C, 120 Hz	
		Extended	2.5 V to 10 V : 0.08 max.(0.1 max.)* ³ (0.12max.)* ⁴ 16 V to 35 V : 0.06 max.										
9	Surge voltage test	Δ C/C : ± 5 % Dissipation factor : Initial requirement Leakage current : Initial requirement										at 85°C Surge voltage for 30 sec. (Rs = 1 k Ω) Discharge for 5 min. 30 sec. 1000 cycles	
10	High and low stability temperature	Temp.	-55 °C			+85 °C			+125 °C			Step 1 : +25 °C Step 2 : -55 °C Step 3 : +25 °C Step 4 : +85 °C Step 5 : +125 °C Step 6 : +25 °C	
		Δ C/C	± 12 %			± 12 %			± 15 %				
		Dissipation factor	Standard	0.047 to 4.7 μ F : 0.08 max. (0.12 max.)*			Initial requirement			Standard 0.047 to 4.7 μ F : 0.06 max. 6.8 to 68 μ F : 0.08 max.			
			Extended	6.8 to 68 μ F : 0.1 max. (0.12 max.)* 2.5 V to 10 V : 0.12 max. (0.14 max.)* ³ (0.16 max.)* ⁴ 16 V to 35 V : 0.1 max.						Extended 2.5 V to 10 V : 0.1 max. (0.12 max.)* ³ (0.14 max.)* ⁴ 16 V to 35 V : 0.08 max.			
Leakage current	-			0.1 CV or 5 μ A whichever is greater			0.125 CV or 6.25 μ A whichever is greater						
11	Temperature cycling test	Δ C/C : ± 5 % (± 12 %) * ² Dissipation factor : initial requirement Leakage current : Initial requirement										-55 to +125 °C 5 cycles	
12	Soldeing heat resistance test	Δ C/C : ± 5 % (± 12 %) * ² Dissipation factor : Initial requirement Leakage current : Initial requirement										Fully immersion to solder, 260 °C, 5 sec.	
13	Humidity test	Δ C/C : ± 5 % (± 12 %) * ² Dissipation factor : 150 % of initial requirement leakage current : Initial requirement										at 40 °C, 90 to 95 % RH 500 H	
14	Load life test	Δ C/C : ± 10 %, (± 12 %) * ² Dissipation factor : Initial requirement Leakage current : Initial requirement										at 85 °C Rated voltage applied 1000 H	
15	Failure rate	$\lambda_0 = 1\% / 1000H$										at 85 °C Rated voltage applied 1000H	

LEGEND

CV : Product of capacitance in μF and voltage in V
 $\Delta\text{C}/\text{C}$: Capacitance change ratio

* : Dissipation factor of 0.12 applies to the specific products of R-series Standard in the following product
 4V/3.3 μF , 4.7 μF , 10 μF , 22 μF , 33 μF , 68 μF , 6.3 V/2.2 μF , 3.3 μF , 6.8 μF , 15 μF , 22 μF , 47 μF

*2: Capacitance change of $\pm 12\%$ applies to the specific products of R-series Extended in the following table.

Case code	Product
A2 (U)	2.5 V/4.7 μF , 6.8 μF , 10 μF , 15 μF , 4 V/4.7 μF , 6.8 μF , 10 μF , 6.3 V/3.3 μF , 4.7 μF , 6.8 μF , 10 V/2.2 μF , 3.3 μF , 16 V/1.5 μF , 2.2 μF , 20 V/1 μF , 1.5 μF
A	2.5 V/15 μF , 22 μF , 33 μF , 4 V/10 μF , 15 μF , 22 μF , 6.3 V/6.8 μF , 10 μF , 15 μF , 10 V/4.7 μF , 6.8 μF , 10 μF , 16 V/3.3 μF , 4.7 μF , 20 V/2.2 μF , 3.3 μF , 25 V/1.5 μF , 2.2 μF , 35 V/1 μF , 1.5 μF ,
B2 (S)	2.5 V/33 μF , 47 μF , 68 μF
C	4 V/150 μF , 6.3 V/100 μF , 10V/68 μF

*3: Dissipation factor of marked *3 applies to the specific products of R series Extended in the following table.

Case code	Product
C	4 V/150 μF , 6.3 V/100 μF

*4: Dissipation factor of marked *4 applies to the specific products of R series Extended in the following table.

Case code	Product
A2 (U)	2.5 V/15 μF , 4 V/10 μF

OUTLINE DRAWINGS AND DIMENSIONS

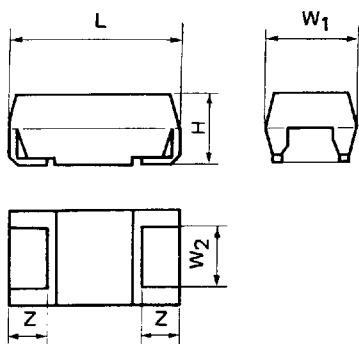

[A2 & A cases]

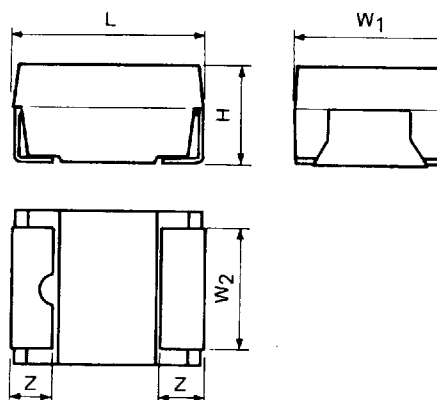

[B2 case]

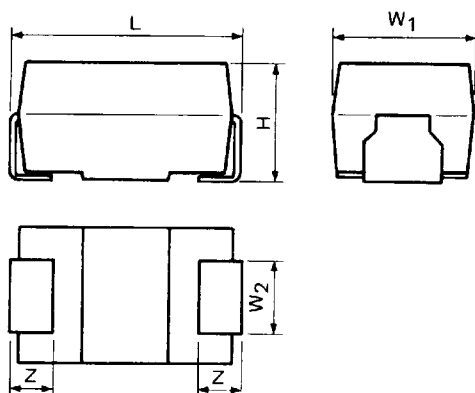

[D2 case]

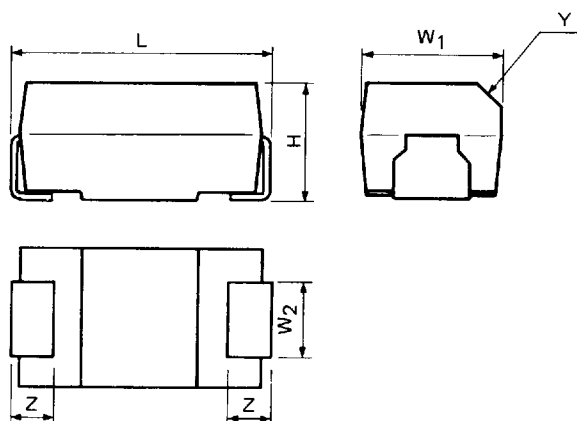

[B, C & D cases]

Unit: mm (inch)

Case code	L	W ₁	W ₂	H	Z	Y
A2 (U)	3.2±0.2 (0.126±0.008)	1.6±0.2 (0.063±0.008)	1.2±0.1 (0.047±0.004)	1.2 MAX. (0.047 MAX.)	0.8±0.3 (0.031±0.012)	—
A	3.2±0.2 (0.126±0.008)	1.6±0.2 (0.063±0.008)	1.2±0.1 (0.047±0.004)	1.6±0.2 (0.063±0.008)	0.8±0.3 (0.031±0.012)	—
B2 (S)	3.5±0.2 (0.138±0.008)	2.8±0.2 (0.110±0.008)	2.3±0.1 (0.091±0.004)	1.9±0.2 (0.075±0.008)	0.8±0.3 (0.031±0.012)	—
B	4.7±0.3 (0.185±0.012)	2.6±0.3 (0.102±0.012)	1.4±0.1 (0.055±0.004)	2.1±0.3 (0.083±0.012)	0.8±0.3 (0.031±0.012)	C 0.4 (0.016)
C	6.0±0.3 (0.236±0.012)	3.2±0.3 (0.126±0.012)	1.8±0.1 (0.071±0.004)	2.5±0.3 (0.098±0.012)	1.3±0.3 (0.051±0.012)	C 0.4 (0.016)
D2 (T)	5.8±0.3 (0.228±0.012)	4.6±0.3 (0.181±0.012)	2.4±0.1 (0.094±0.004)	3.2±0.3 (0.126±0.012)	1.3±0.3 (0.051±0.012)	—
D	7.3±0.3 (0.287±0.012)	4.3±0.3 (0.169±0.012)	2.4±0.1 (0.094±0.004)	2.8±0.3 (0.110±0.012)	1.3±0.3 (0.051±0.012)	C 0.5 (0.020)

MARKING

— Upper face —

[A2 & A Case]

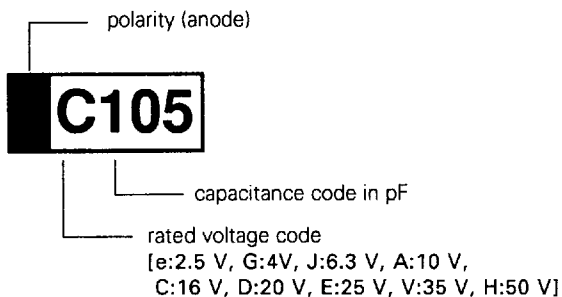

[B Case]

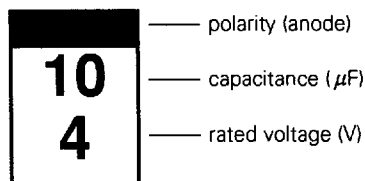

[C & D Case]

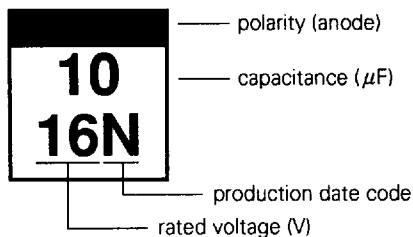

[B2 & D2 Case]

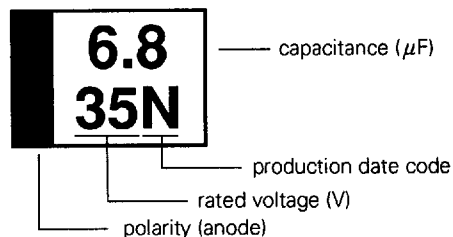

[Marking of production date code]

Y \ M	Jan.	Feb.	Mar.	Apr.	May	Jun.	Jul.	Aug.	Sept.	Oct.	Nov.	Dec.
1994	N	P	Q	R	S	T	U	V	W	X	Y	Z
1995	a	b	c	d	e	f	g	h	j	k	l	m
1996	n	p	q	r	s	t	u	v	w	x	y	z
1997	A	B	C	D	E	F	G	H	J	K	L	M

Date code will resume for beginning in 1998.

PRODUCT LINE-UP AND CASE CODE

R SERIES STANDARD

Rated voltage (Vdc) \ Capacitance (μF)	4	6.3	10	16	20	25	35	50
0.010								
0.015								
0.022								
0.033								
0.047							A	
0.068							A	
0.10							A	A
0.15							A	A
0.22							A	B2
0.33							A	B2
0.47						A	B2 B	B2
0.68					A		B2 B	C
1.0				A			B2 B	C
1.5			A	A		B2 B	C	C
2.2		A	A		B2 B		C	D
3.3	A	A		B2 B		C	C D	D D2
4.7	A		B2 B		C	C	D2 D	D
6.8		B2 B		C	C	D2 D	D2 D	
10	B2 B		C	C	D2 D	D2 D		
15		C	C	D2 D	D2 D			
22	C	C	D2 D	D2 D				
33	C	D2 D	D2 D					
47	D2 D	D2 D						
68	D2 D							

R SERIES EXTENDED

Rated voltage (Vdc) Capacitance (μF)	2.5	4	6.3	10	16	20	25	35
0.1						A2		
0.15						A2		
0.22						A2		
0.33						A2		
0.47						A2		A
0.68					A2	A2		A
1				A2	A2	A2	A	A
1.5			A2	A2	A2	A2 A	A	A B2 B
2.2		A2	A2	A2	A2 A	A	A B2	B2 B
3.3		A2	A2	A2 A	A	A B2	B2 B	B2
4.7	A2	A2	A2 A	A	A B2	B2 B	B2	C
6.8	A2	A2 A	A2 A	A B2	B2 B	B2	C	C
10	A2	A2 A	A B2	A B2 B	B2	B2 C	C	D
15	A2 A	A B2	A B2 B	B2	B2 C	C	D	D
22	A	A B2 B	B2	B2 C	C	C D2 D	D	
33	A B2	B2	B2 C	B2 C	C D2 D	D2 D		
47	B2	B2 C	B2 C	C D2 D	D2 D	D		
68	B2	B2 C	C D2 D	C D2 D	D			
100		C D2 D	C D2 D	D				
150		C D2 D	D					
220		D						

PART NUMBER SYSTEM

Bulk

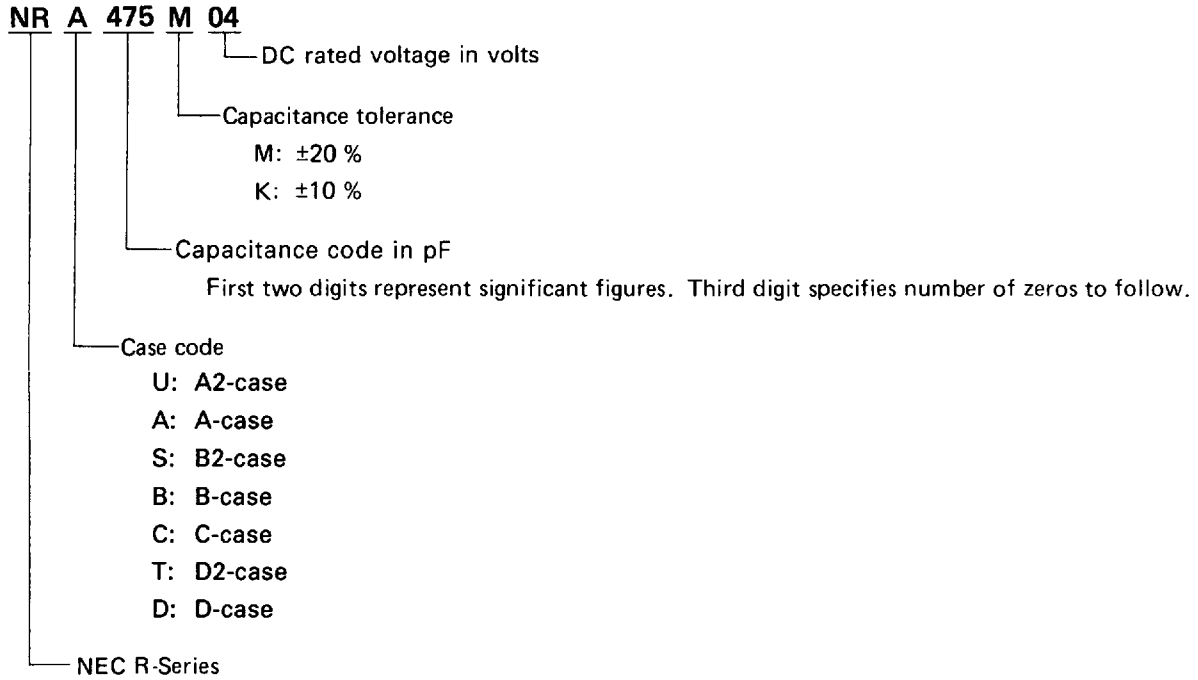

Tape and reel

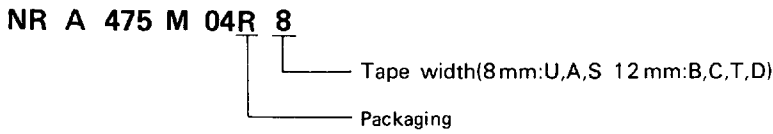

R: Reel diameter 178 mm (7 inch)

Orientation

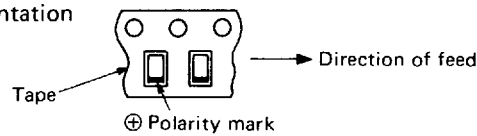

L: Reel diameter 178 mm (7 inch)

Orientation

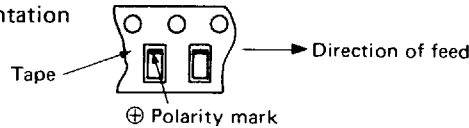

P: Reel diameter 330 mm (13 inch)

Orientation

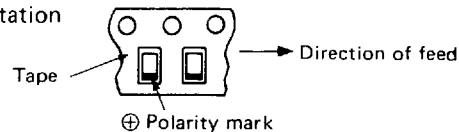

N: Reel diameter 330 mm (13 inch)

Orientation

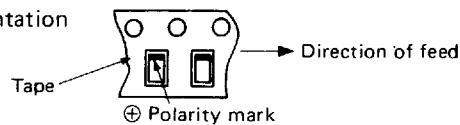

RATINGS AND PART NUMBER

Standard type

Rated voltage @85°C (125°C) Vdc	Capacitance @25°C, 120Hz μF	Part number	Case code	Leakage current @25°C μA max.	Dissipation factor @25°C, 120Hz % max.
50 (32)	0.1	NRA104M50	A	0.5	4
	0.15	NRA154M50	A	0.5	4
	0.22	NRS224M50	B2(S)	0.5	4
	0.33	NRS334M50	B2(S)	0.5	4
	0.47	NRS474M50	B2(S)	0.5	4
	0.68	NRC684M50	C	0.5	4
	1	NRC105M50	C	0.5	4
	1.5	NRC155M50	C	0.7	4
	2.2	NRD225M50	D	1.1	4
	3.3	NRT335M50	D2(T)	1.6	4
	3.3	NRD335M50	D	1.6	4
	4.7	NRD475M50	D	2.3	4
35 (22)	0.047	NRA473M35	A	0.5	4
	0.068	NRA683M35	A	0.5	4
	0.1	NRA104M35	A	0.5	4
	0.15	NRA154M35	A	0.5	4
	0.22	NRA224M35	A	0.5	4
	0.33	NRA334M35	A	0.5	4
	0.47	NRS474M35	B2(S)	0.5	4
	0.47	NRB474M35	B	0.5	4
	0.68	NRS684M35	B2(S)	0.5	4
	0.68	NRB684M35	B	0.5	4
	1	NRS105M35	B2(S)	0.5	4
	1	NRB105M35	B	0.5	4
	1.5	NRC155M35	C	0.5	4
	2.2	NRC225M35	C	0.7	4
	3.3	NRC335M35	C	1.2	4
	3.3	NRD335M35	D	1.2	4
	4.7	NRT475M35	D2(T)	1.6	4
	4.7	NRD475M35	D	1.6	4
6.8	NRT685M35	D2(T)	2.3	6	
6.8	NRD685M35	D	2.3	6	
25 (16)	0.47	NRA474M25	A	0.5	4
	1.5	NRS155M25	B2(S)	0.5	4
	1.5	NRB155M25	B	0.5	4
	3.3	NRC335M25	C	0.8	4
	4.7	NRC475M25	C	1.1	4
	6.8	NRT685M25	D2(T)	1.7	6
	6.8	NRD685M25	D	1.7	6
	10	NRT106M25	D2(T)	2.5	6
	10	NRD106M25	D	2.5	6
20 (13)	0.68	NRA684M20	A	0.5	4
	2.2	NRS225M20	B2(S)	0.5	4
	2.2	NRB225M20	B	0.5	4
	4.7	NRC475M20	C	0.9	4
	6.8	NRC685M20	C	1.4	6
	10	NRT106M20	D2(T)	2.0	6
	10	NRD106M20	D	2.0	6
	15	NRT156M20	D2(T)	3.0	6
15	NRD156M20	D	3.0	6	

Rated voltage @85°C (125°C) Vdc	Capacitance @25°C, 120Hz μF	Part number	Case code	Leakage current @25°C μA max.	Dissipation factor @25°C, 120Hz % max.
16 (10)	1	NRA105M16	A	0.5	4
	1.5	NRA155M16	A	0.5	4
	3.3	NRS335M16	B2(S)	0.5	4
	3.3	NRB335M16	B	0.5	4
	6.8	NRC685M16	C	1.0	6
	10	NRC106M16	C	1.6	6
	15	NRT156M16	D2(T)	2.4	6
	15	NRD156M16	D	2.4	6
	22	NRT226M16	D2(T)	3.5	6
	22	NRD226M16	D	3.5	6
10 (6.3)	1.5	NRA155M10	A	0.5	4
	2.2	NRA225M10	A	0.5	4
	4.7	NRS475M10	B2(S)	0.5	4
	4.7	NRB475M10	B	0.5	4
	10	NRC106M10	C	1.0	6
	15	NRC156M10	C	1.5	6
	22	NRT226M10	D2(T)	2.2	6
	22	NRD226M10	D	2.2	6
	33	NRT336M10	D2(T)	3.3	6
	33	NRD336M10	D	3.3	6
6.3 (4)	2.2	NRA225M06	A	0.5	4
	3.3	NRA335M06	A	0.5	4
	6.8	NRS685M06	B2(S)	0.5	6
	6.8	NRB685M06	B	0.5	6
	15	NRC156M06	C	0.9	6
	22	NRC226M06	C	1.4	6
	33	NRT336M06	D2(T)	2.0	6
	33	NRD336M06	D	2.0	6
	47	NRT476M06	D2(T)	3.0	6
	47	NRD476M06	D	3.0	6
4 (2.5)	3.3	NRA335M04	A	0.5	4
	4.7	NRA475M04	A	0.5	4
	10	NRS106M04	B2(S)	0.5	6
	10	NRB106M04	B	0.5	6
	22	NRC226M04	C	0.8	6
	33	NRC336M04	C	1.3	6
	47	NRT476M04	D2(T)	1.9	6
	47	NRD476M04	D	1.9	6
	68	NRT686M04	D2(T)	2.7	6
	68	NRD686M04	D	2.7	6

Extended type

Rated voltage @85°C (125°C) Vdc	Capacitance @25°C, 120Hz μF	Part number	Case code	Leakage current @25°C μA max.	Dissipation factor @25°C, 120Hz % max.
35 (22)	0.47	NRA474M35	A	0.5	6
	0.68	NRA684M35	A	0.5	6
	1	NRA105M35	A	0.5	6
	1.5	NRA155M35	A	0.5	6
	1.5	NRS155M35	B2(S)	0.5	6
	1.5	NRB155M35	B	0.5	6
	2.2	NRS225M35	B2(S)	0.7	6
	2.2	NRB225M35	B	0.7	6
	3.3	NRS335M35	B2(S)	1.1	6
	4.7	NRC475M35	C	1.6	6
	6.8	NRC685M35	C	2.3	6
	10	NRD106M35	D	3.5	6
	15	NRD156M35	D	5.2	6
25 (16)	1	NRA105M25	A	0.5	6
	1.5	NRA155M25	A	0.5	6
	2.2	NRA225M25	A	0.5	6
	2.2	NRS225M25	B2(S)	0.5	6
	3.3	NRS335M25	B2(S)	0.8	6
	3.3	NRB335M25	B	0.8	6
	4.7	NRS475M25	B2(S)	1.1	6
	6.8	NRC685M25	C	1.7	6
	10	NRC106M25	C	2.5	6
	15	NRD156M25	D	3.7	6
22	NRD226M25	D	5.5	6	
20 (13)	0.1	NRU104M20	A2(U)	0.5	6
	0.15	NRU154M20	A2(U)	0.5	6
	0.22	NRU224M20	A2(U)	0.5	6
	0.33	NRU334M20	A2(U)	0.5	6
	0.47	NRU474M20	A2(U)	0.5	6
	0.68	NRU684M20	A2(U)	0.5	6
	1	NRU105M20	A2(U)	0.5	6
	1.5	NRU155M20	A2(U)	0.5	6
	1.5	NRA155M20	A	0.5	6
	2.2	NRA225M20	A	0.5	6
	3.3	NRA335M20	A	0.6	6
	3.3	NRS335M20	B2(S)	0.6	6
	4.7	NRS475M20	B2(S)	0.9	6
	4.7	NRB475M20	B	0.9	6
	6.8	NRS685M20	B2(S)	1.4	6
	10	NRS106M20	B2(S)	2.0	6
	10	NRC106M20	C	2.0	6
	15	NRC156M20	C	3.0	6
	22	NRC226M20	C	4.4	6
	22	NRT226M20	D2(T)	4.4	6
22	NRD226M20	D	4.4	6	
33	NRT336M20	D2(T)	6.6	6	
33	NRD336M20	D	6.6	6	
47	NRD476M20	D	9.4	6	
16 (10)	0.68	NRU684M16	A2(U)	0.5	6
	1	NRU105M16	A2(U)	0.5	6
	1.5	NRU155M16	A2(U)	0.5	6
	2.2	NRU225M16	A2(U)	0.5	6
	2.2	NRA225M16	A	0.5	6
	3.3	NRA335M16	A	0.5	6
4.7	NRA475M16	A	0.7	6	

Rated voltage @85°C (125°C) Vdc	Capacitance @25°C, 120Hz μF	Part number	Case code	Leakage current @25°C μA max.	Dissipation factor @25°C, 120Hz % max.
16 (10)	4.7	NRS475M16	B2(S)	0.7	6
	6.8	NRS685M16	B2(S)	1.0	6
	6.8	NRB685M16	B	1.0	6
	10	NRS106M16	B2(S)	1.6	6
	15	NRS156M16	B2(S)	2.4	6
	15	NRC156M16	C	2.4	6
	22	NRC226M16	C	3.5	6
	33	NRC336M16	C	5.2	6
	33	NRT336M16	D2(T)	5.2	6
	33	NRD336M16	D	5.2	6
	47	NRT476M16	D2(T)	7.5	6
	47	NRD476M16	D	7.5	6
	68	NRD686M16	D	10.8	6
10 (6.3)	1	NRU105M10	A2(U)	0.5	8
	1.5	NRU155M10	A2(U)	0.5	8
	2.2	NRU225M10	A2(U)	0.5	8
	3.3	NRU335M10	A2(U)	0.5	8
	3.3	NRA335M10	A	0.5	8
	4.7	NRA475M10	A	0.5	8
	6.8	NRA685M10	A	0.6	8
	6.8	NRS685M10	B2(S)	0.6	8
	10	NRA106M10	A	1.0	8
	10	NRS106M10	B2(S)	1.0	8
	10	NRB106M10	B	1.0	8
	15	NRS156M10	B2(S)	1.5	8
	22	NRS226M10	B2(S)	2.2	8
	22	NRC226M10	C	2.2	8
	33	NRS336M10	B2(S)	3.3	8
	33	NRC336M10	C	3.3	8
	47	NRC476M10	C	4.7	8
	47	NRT476M10	D2(T)	4.7	8
	47	NRD476M10	D	4.7	8
	68	NRC686M10	C	6.8	8
68	NRT686M10	D2(T)	6.8	8	
68	NRD686M10	D	6.8	8	
100	NRD107M10	D	10	8	
6.3 (4)	1.5	NRU155M06	A2(U)	0.5	8
	2.2	NRU225M06	A2(U)	0.5	8
	3.3	NRU335M06	A2(U)	0.5	8
	4.7	NRU475M06	A2(U)	0.5	8
	4.7	NRA475M06	A	0.5	8
	6.8	NRU685M06	A2(U)	0.5	8
	6.8	NRA685M06	A	0.5	8
	10	NRA106M06	A	0.6	8
	10	NRS106M06	B2(S)	0.6	8
	15	NRA156M06	A	0.9	8
	15	NRS156M06	B2(S)	0.9	8
	15	NRB156M06	B	0.9	8
	22	NRS226M06	B2(S)	1.4	8
	33	NRS336M06	B2(S)	2.0	8
	33	NRC336M06	C	2.0	8
	47	NRS476M06	B2(S)	3.0	8
	47	NRC476M06	C	3.0	8
	68	NRC686M06	C	4.2	8
	68	NRT686M06	D2(T)	4.2	8
	68	NRD686M06	D	4.2	8
100	NRC107M06	C	6.3	10	
100	NRT107M06	D2(T)	6.3	8	
100	NRD107M06	D	6.3	8	
150	NRD157M06	D	9.4	8	

Rated voltage @85°C (125°C) Vdc	Capacitance @25°C, 120Hz μF	Part number	Case code	Leakage current @25°C μA max.	Dissipation factor @25°C, 120Hz % max.
4 (2.5)	2.2	NRU225M04	A2(U)	0.5	8
	3.3	NRU335M04	A2(U)	0.5	8
	4.7	NRU475M04	A2(U)	0.5	8
	6.8	NRU685M04	A2(U)	0.5	8
	6.8	NRA685M04	A	0.5	8
	10	NRU106M04	A2(U)	0.5	12
	10	NRA106M04	A	0.5	8
	15	NRA156M04	A	0.6	8
	15	NRS156M04	B2(S)	0.6	8
	22	NRA226M04	A	0.8	8
	22	NRS226M04	B2(S)	0.8	8
	22	NRB226M04	B	0.8	8
	33	NRS336M04	B2(S)	1.3	8
	47	NRS476M04	B2(S)	1.8	8
	47	NRC476M04	C	1.8	8
	68	NRC686M04	C	2.7	8
	100	NRC107M04	C	4.0	8
	100	NRT107M04	D2(T)	4.0	8
	100	NRD107M04	D	4.0	8
	150	NRC157M04	C	6.0	10
150	NRD157M04	D	6.0	8	
150	NRT157M04	D2(T)	6.0	8	
220	NRD227M04	D	8.8	8	
2.5 (1.6)	4.7	NRU475M02	A2(U)	0.5	8
	6.8	NRU685M02	A2(U)	0.5	8
	10	NRU106M02	A2(U)	0.5	8
	15	NRU156M02	A2(U)	0.5	12
	15	NRA156M02	A	0.5	8
	22	NRA226M02	A	0.5	8
	33	NRA336M02	A	0.8	8
	33	NRS336M02	B2(S)	0.8	8
	47	NRS476M02	B2(S)	1.1	8
	68	NRS686M02	B2(S)	1.7	8

NOTE

Part numbers in the tables above are for products with a capacitance tolerance of ± 20 %. For products with a capacitance tolerance of ± 10 %, change the letter M to K. Use the letters U, S, and T in part numbers for the case codes A2, B2, and D2.

• R series (standard)

High and low temperature stability

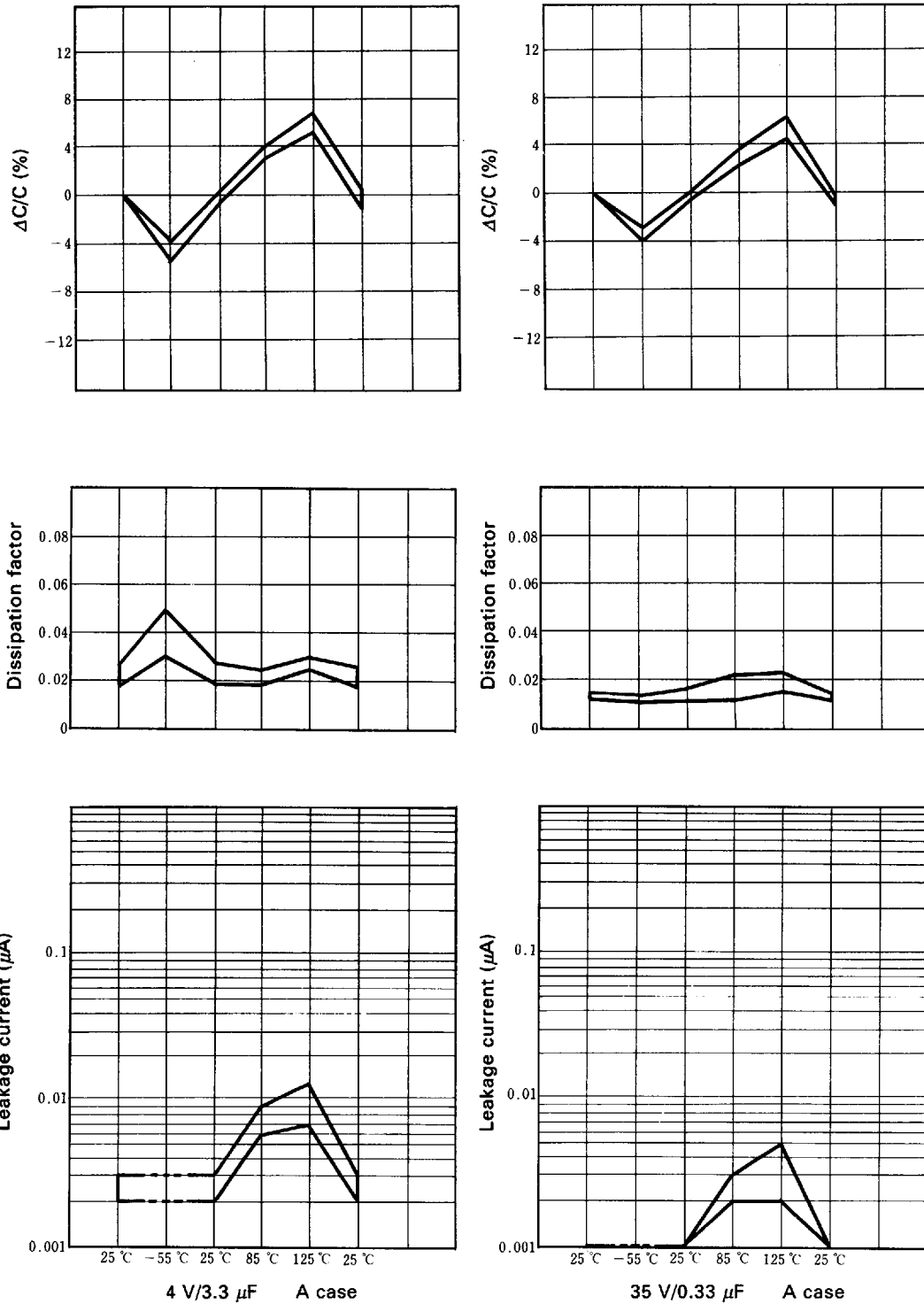

• R series (standard)

High and low temperature stability

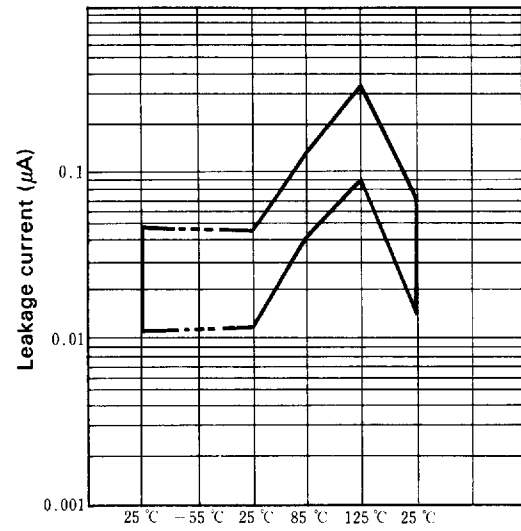
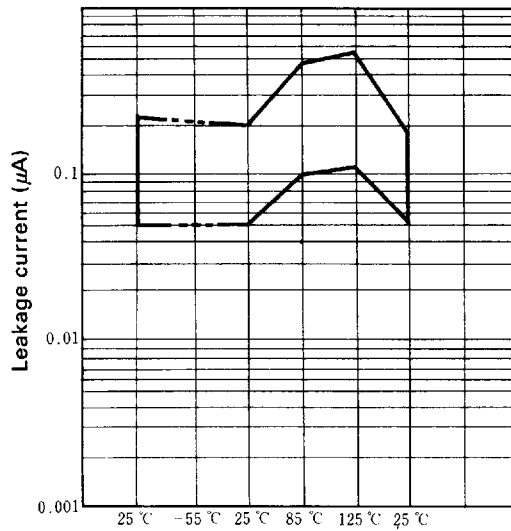
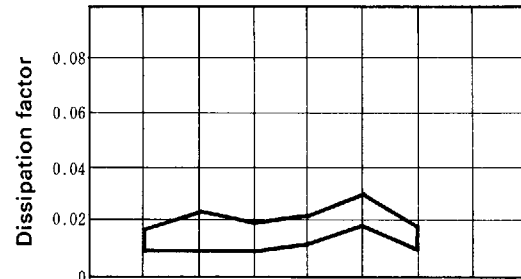
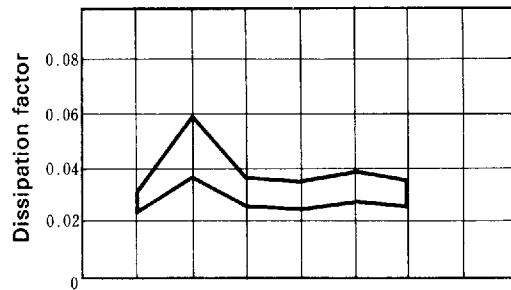
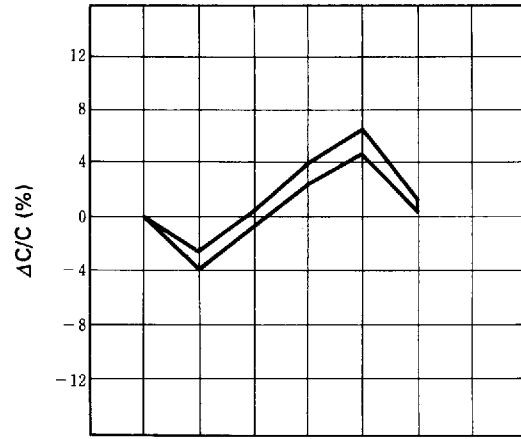
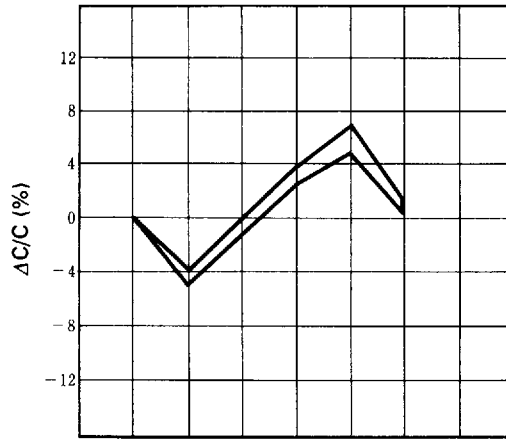

4 V/68 μF D case

35 V/6.8 μF D case

• R series (standard)

Soldering heat resistance (immersing for 10 sec. at 260 °C)

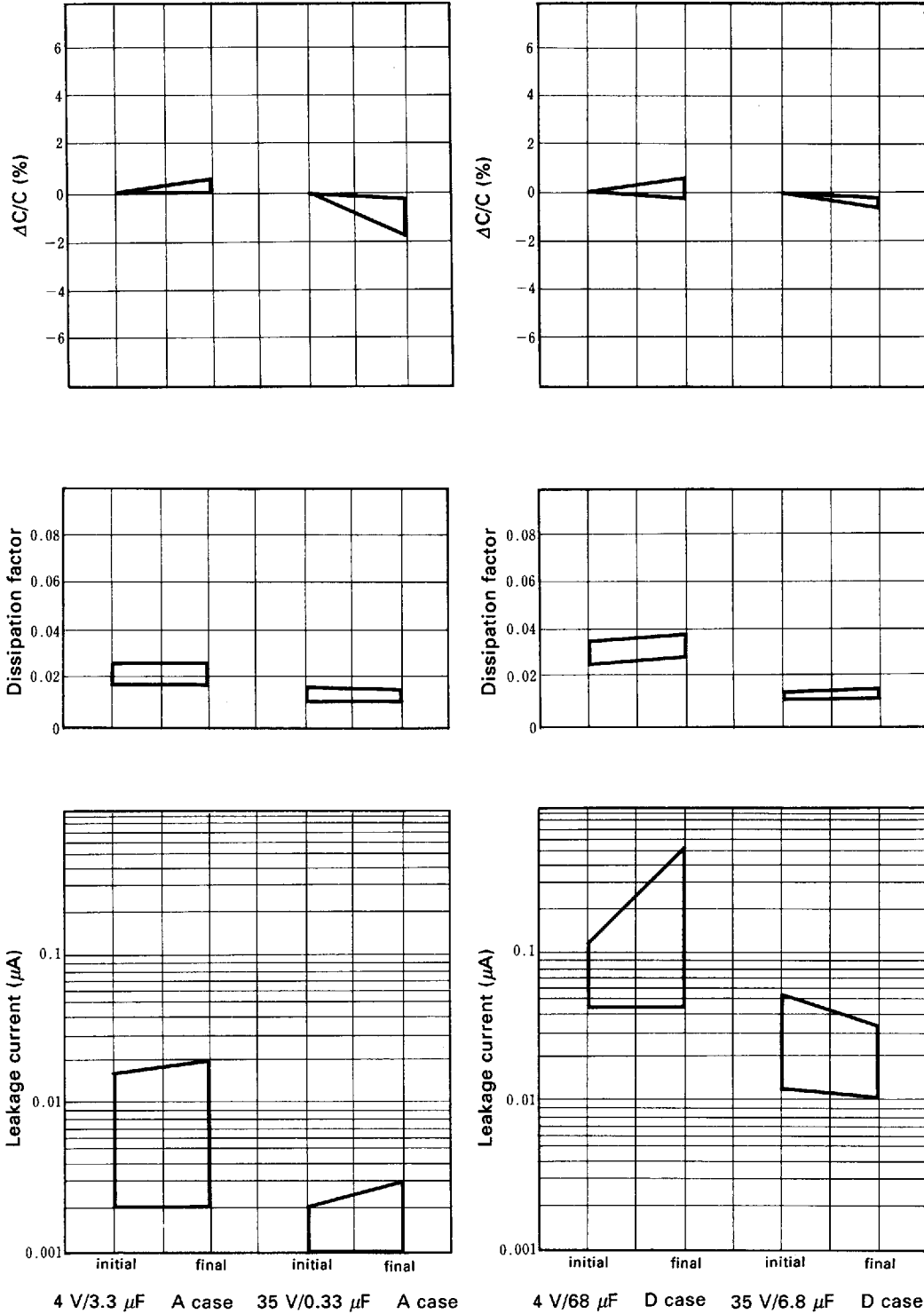

• R series (standard)

Humidity test (40°C, 90~95%RH)

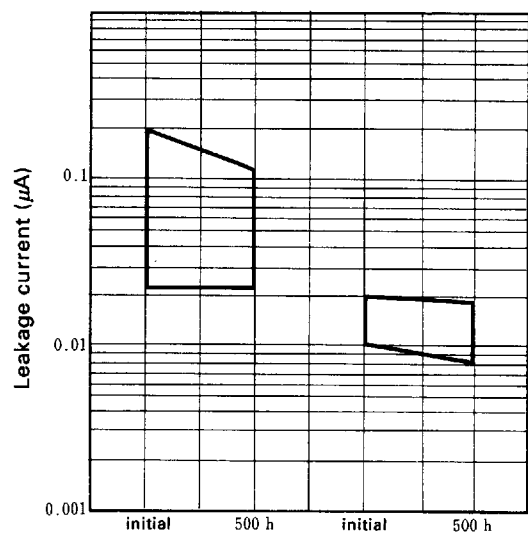
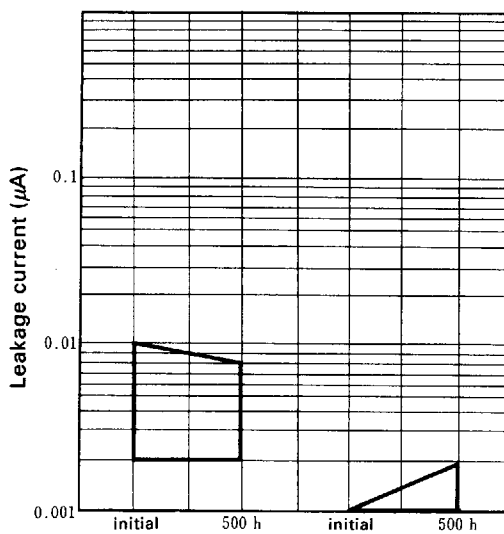
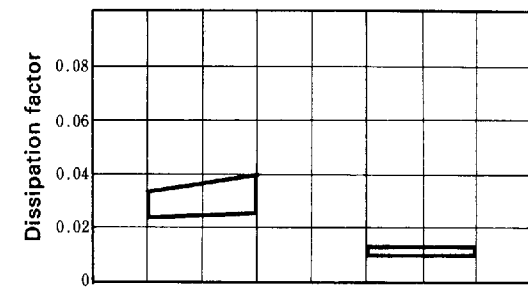
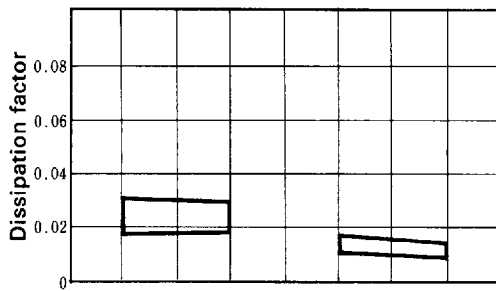
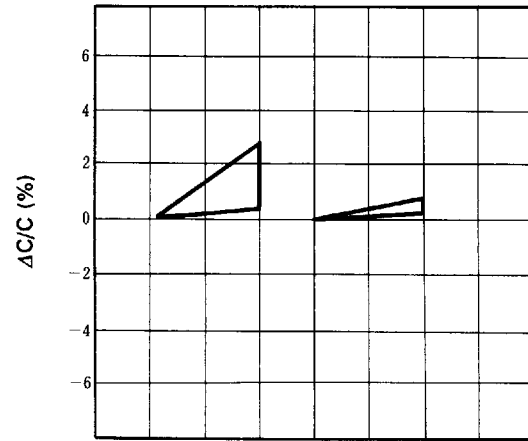
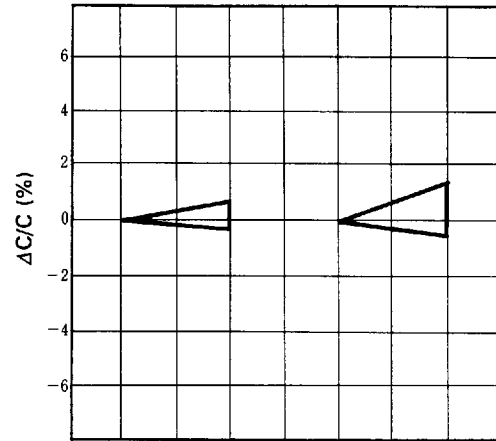

4 V/3.3 μ F A case 35 V/0.33 μ F A case

4 V/68 μ F D case 35 V/6.8 μ F D case

• R series (standard)

Load life (85 °C, rated voltage applied)

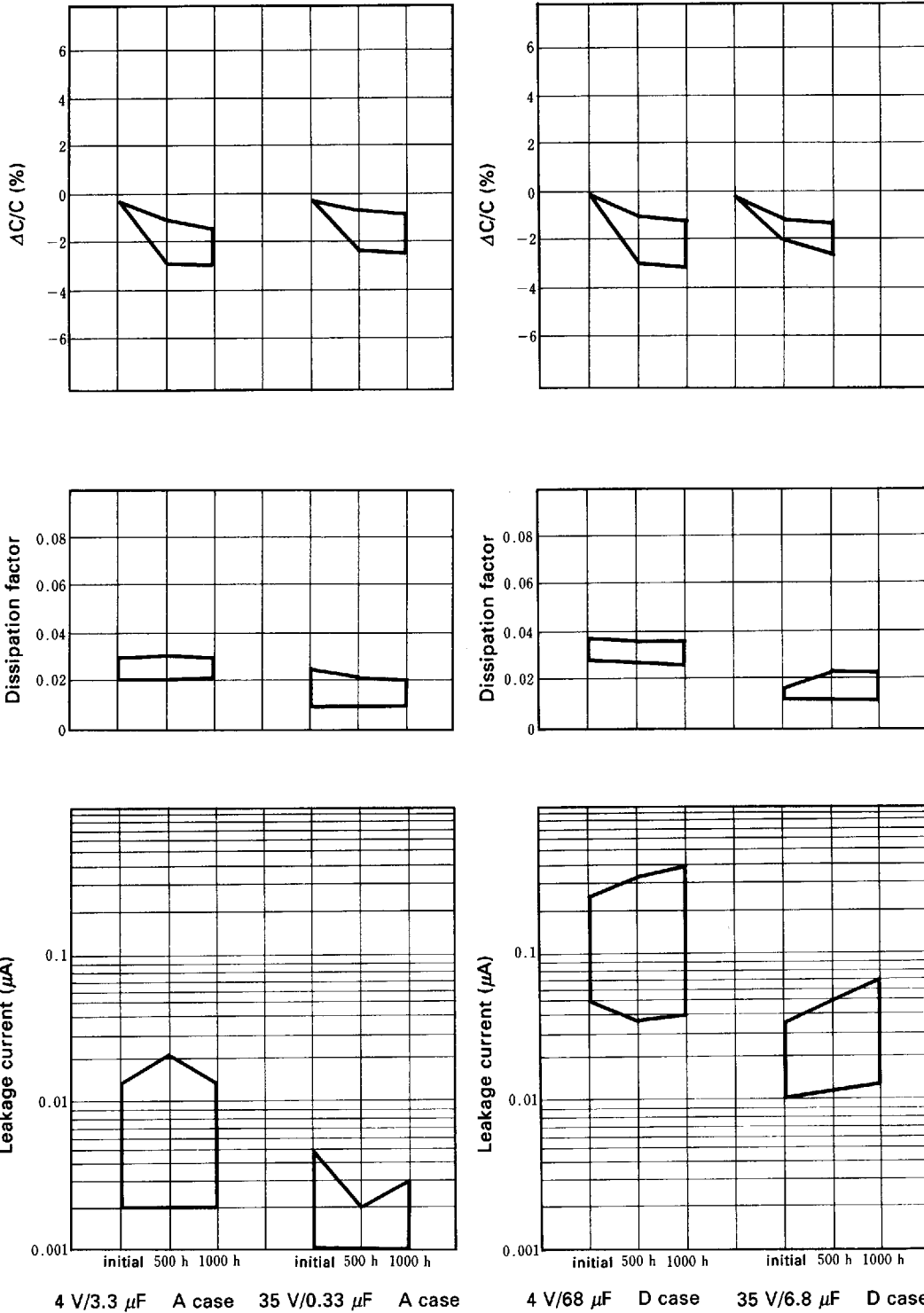

• R series (Extended)

High and low temperature stability

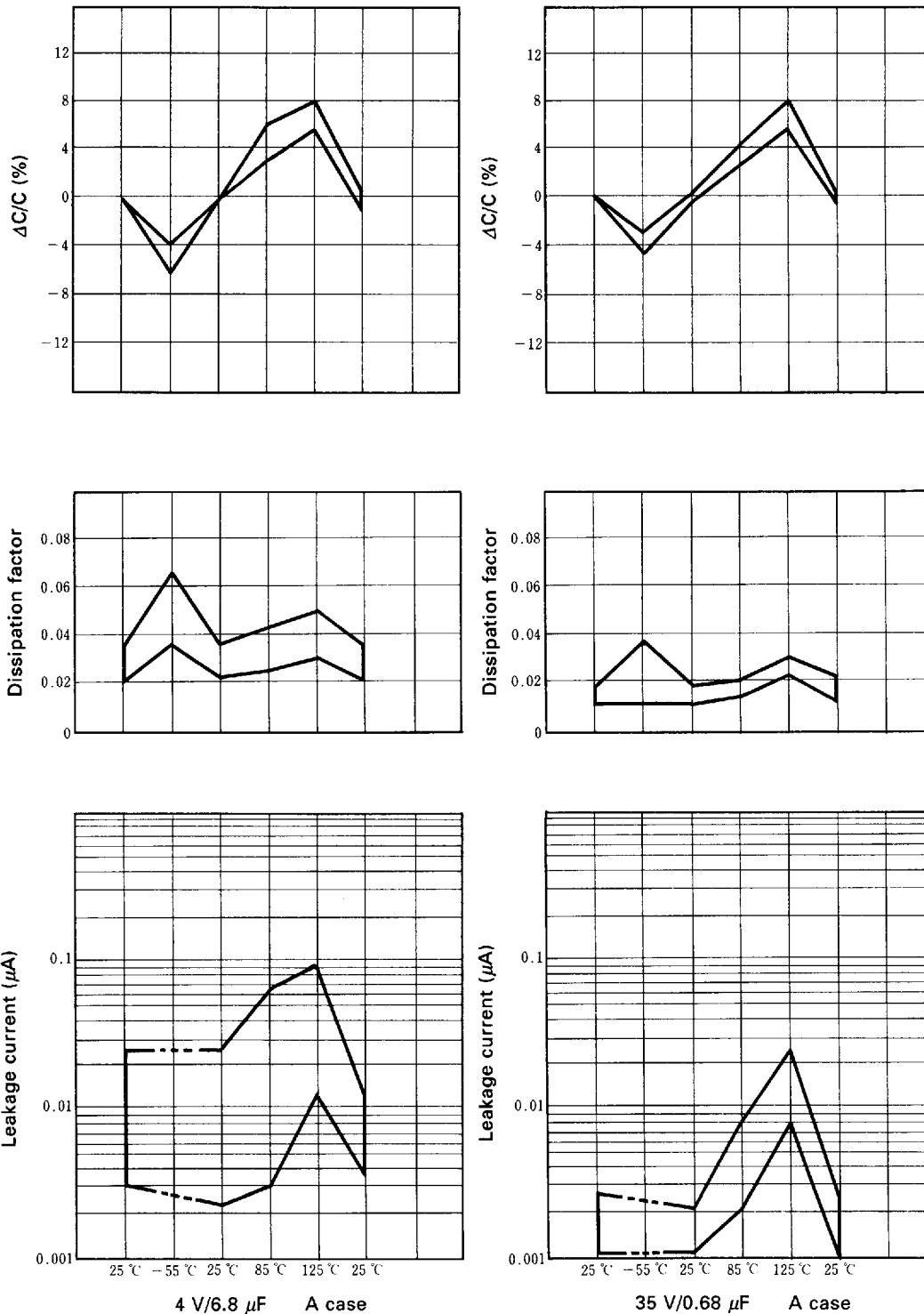

• R series (Extended)

High and low temperature stability

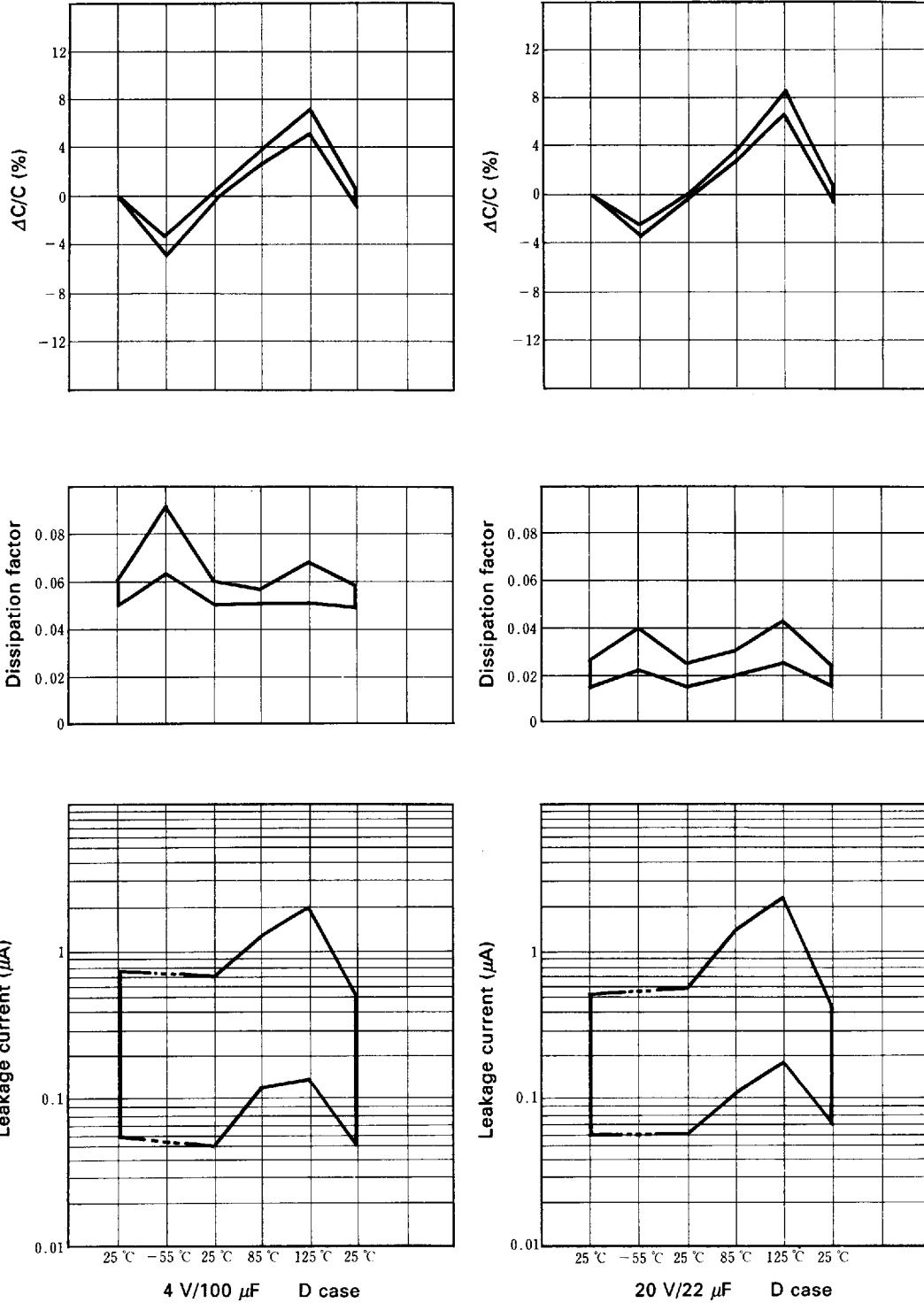

• R series (Extended)

Solder heat resistance (immersing for 10 sec. at 260 °C)

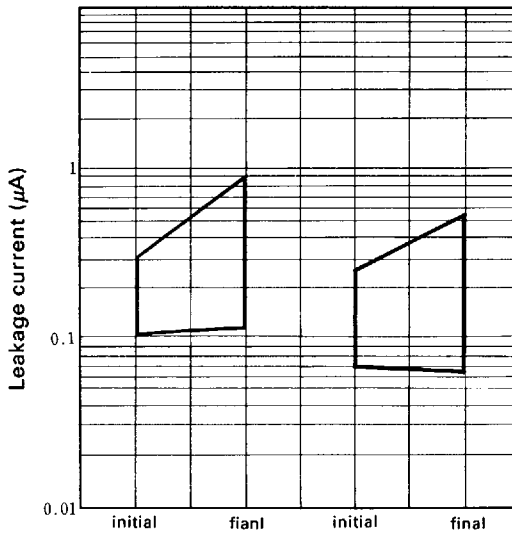
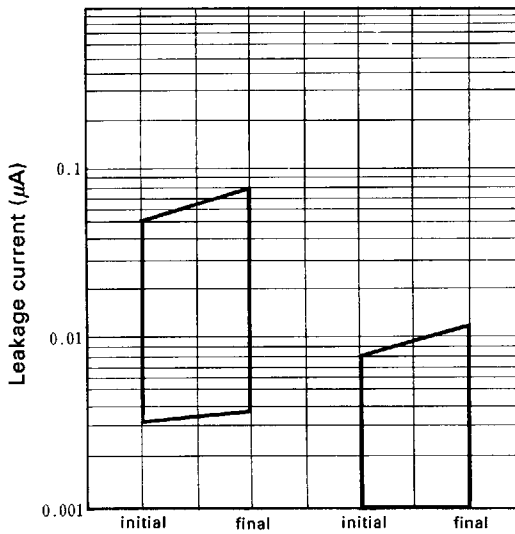
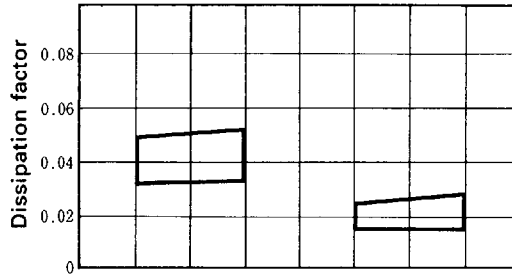
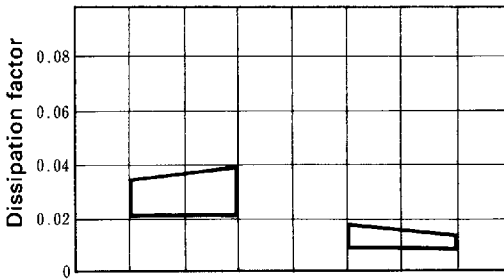
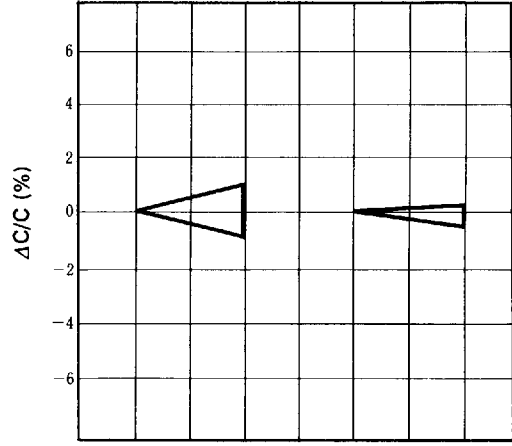
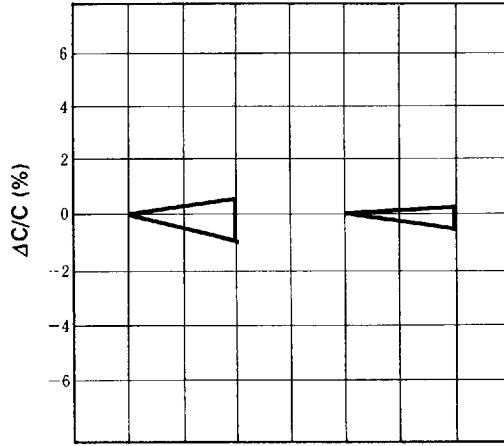

4 V/6.8 μF A case 35 V/0.68 μF A case

4 V/100 μF D case 20 V/22 μF D case

• R series (Extended)

Humidity test (40 °C, 90 to 95% RH)

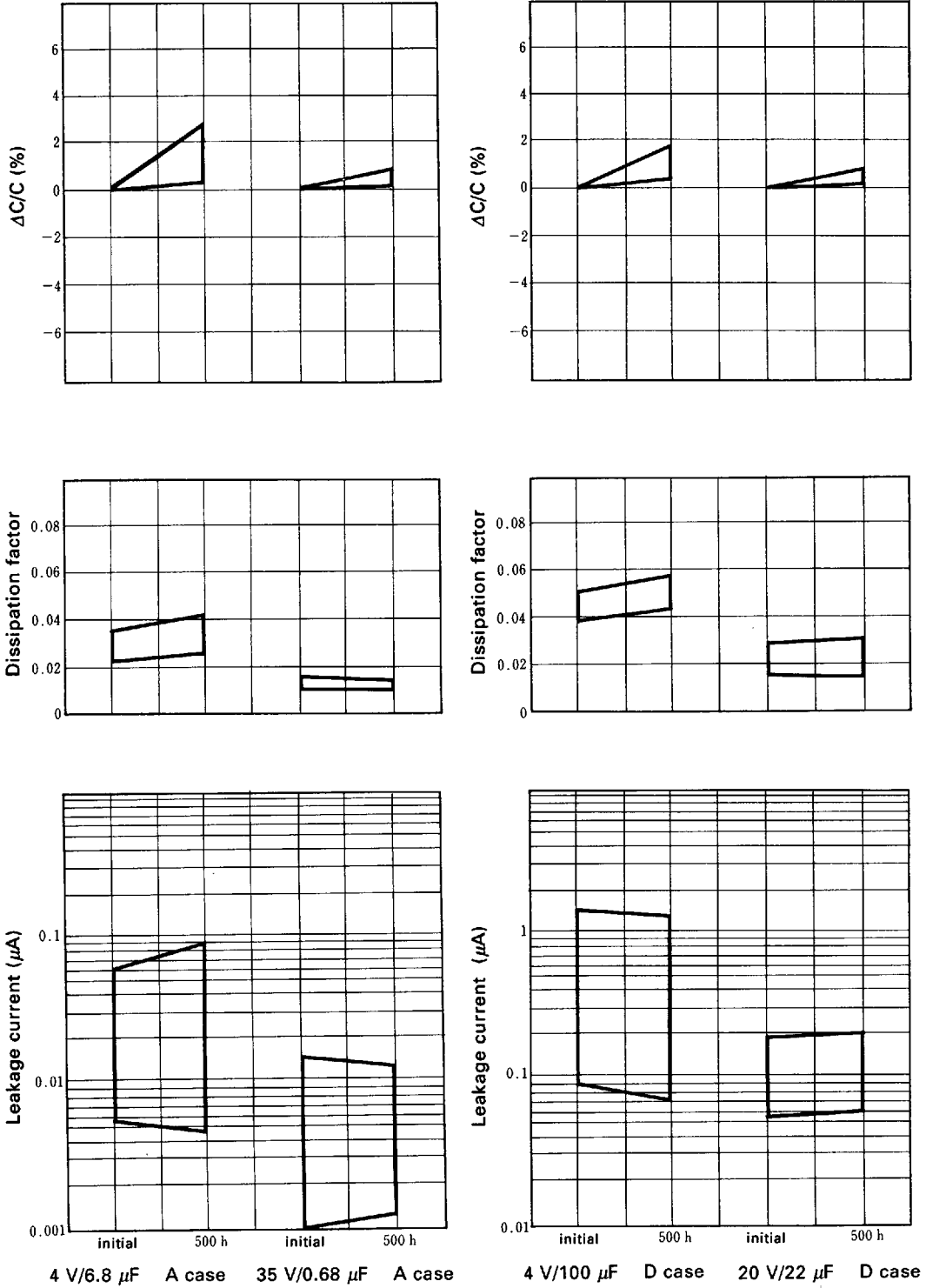

• R series (Extended)

Load life (85°C, rated voltage applied)

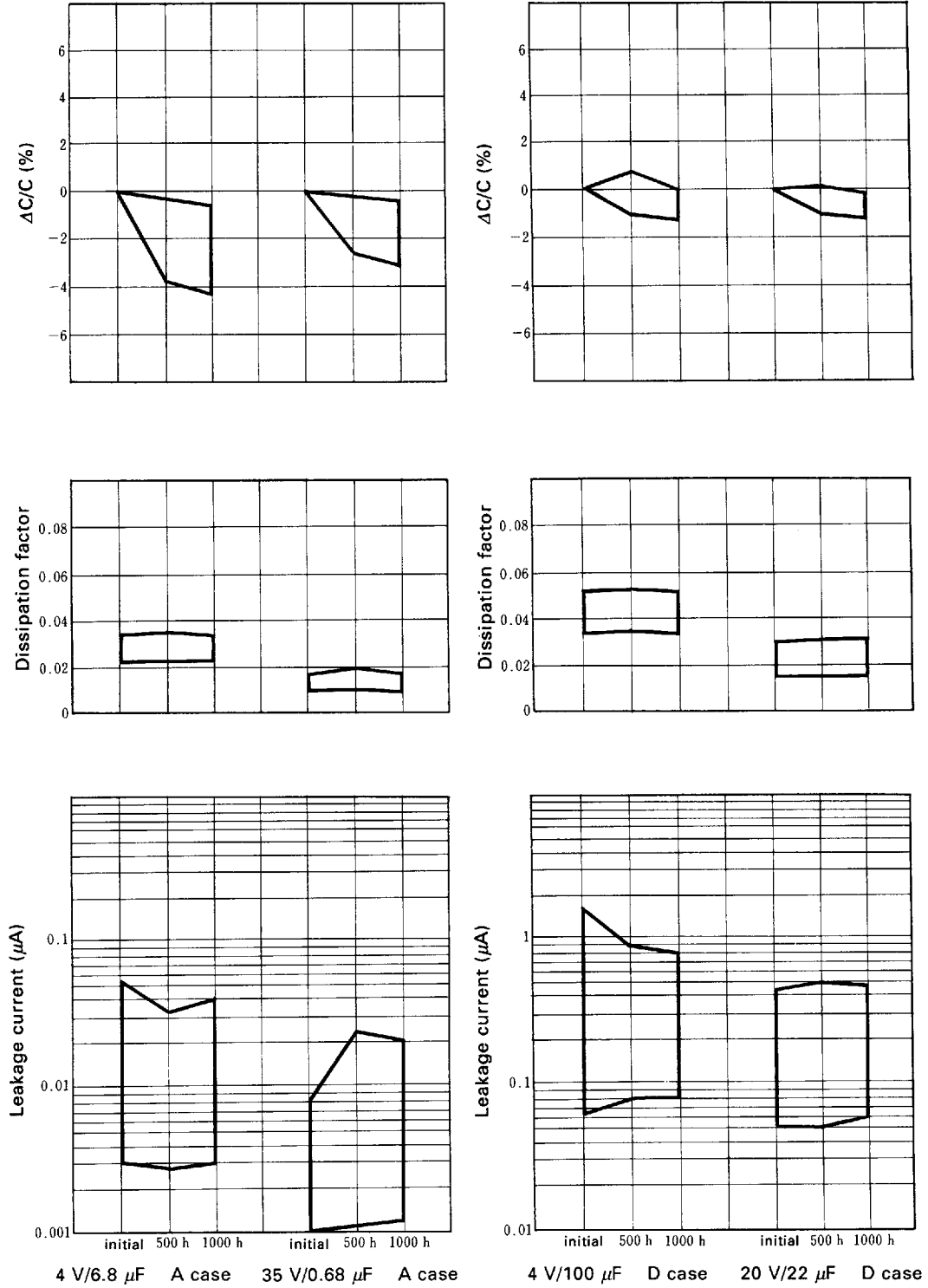

R series (standard)

• Frequency characteristics

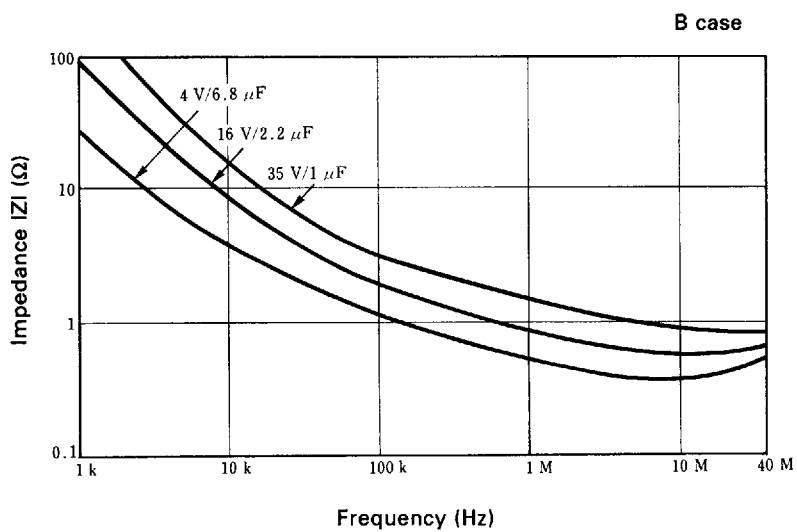
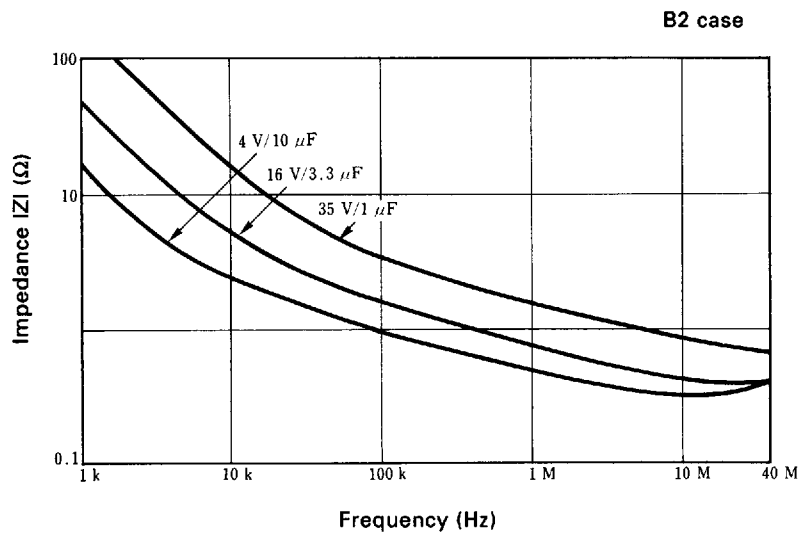
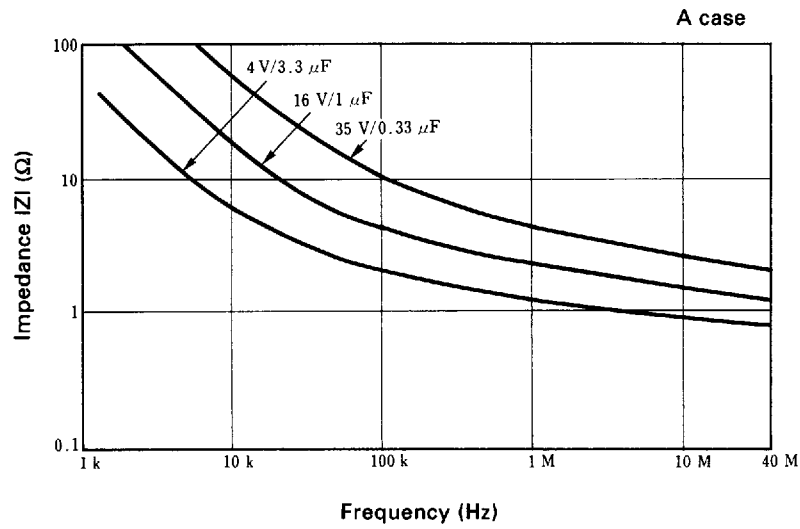

R series (standard)

- Frequency characteristics

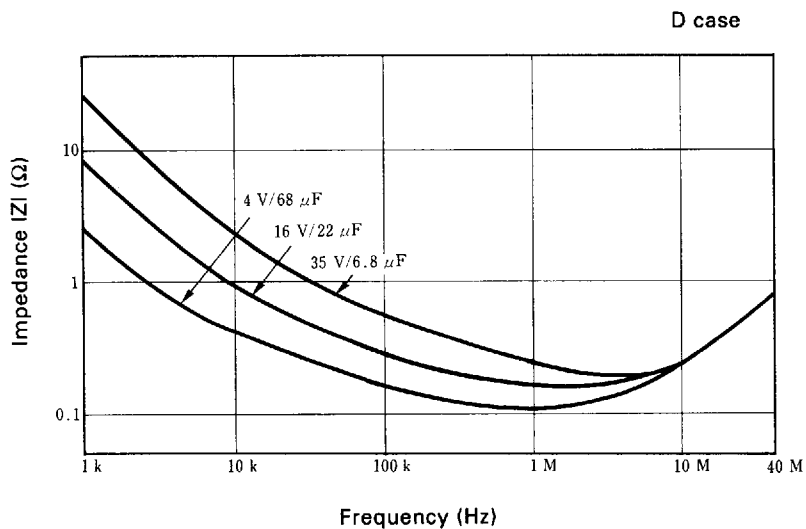
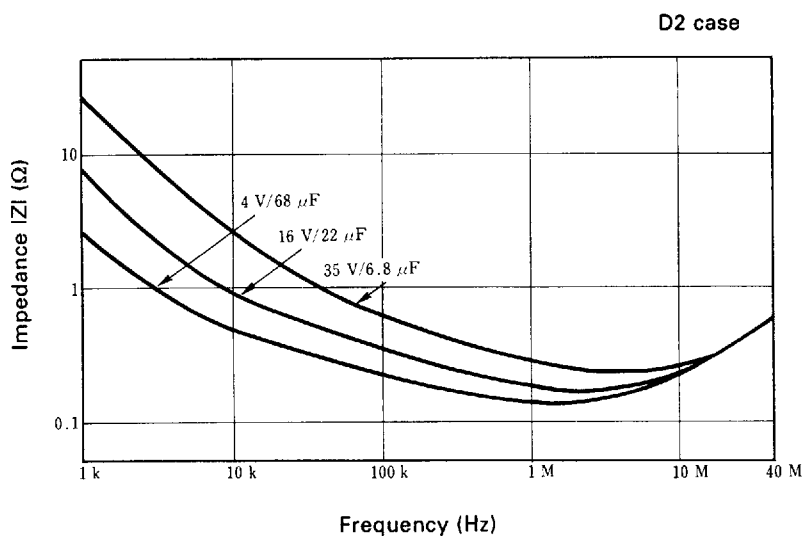
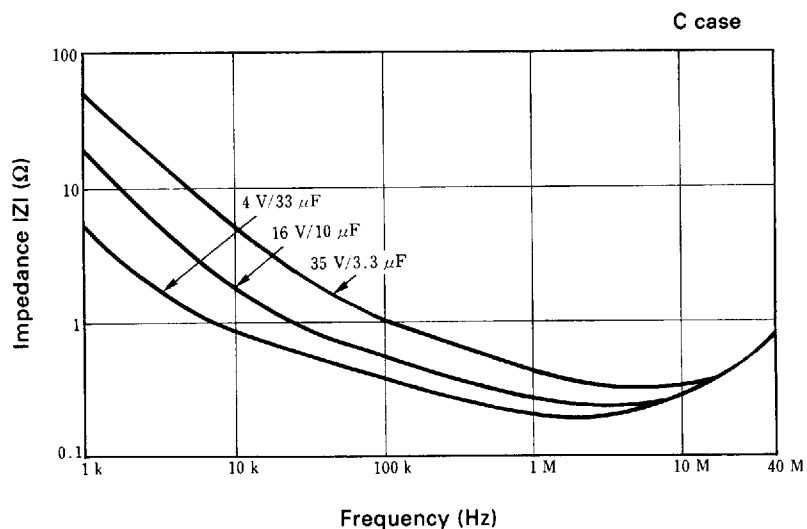

■ TAPE AND REEL SPECIFICATIONS

Plastic tape carrier

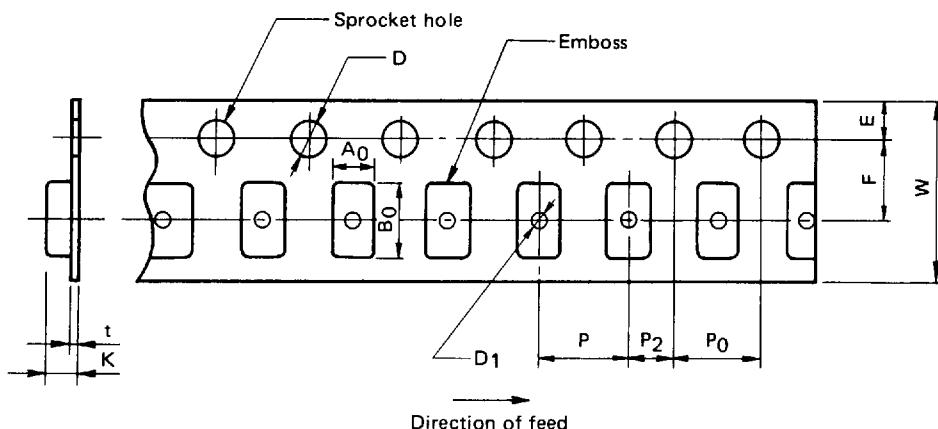

Unit: mm (inch)

Case code	W±0.3 (±0.012)	F±0.1 (±0.004)	E±0.1 (±0.004)	P±0.1 (±0.004)	P ₂ ±0.1 (±0.004)	P ₀ ±0.1 (±0.004)	D ^{+0.1} ₀ (+0.004, 0)	D ₁ min.	t	A ₀ ±0.2 (±0.008)	B ₀ ±0.2 (±0.008)	K±0.2 (±0.008)
A2 (U)	8 (0.315)	3.5 (0.138)	1.75 (0.069)	4 (0.157)	2 (0.079)	4 (0.157)	φ1.5 (0.059)	φ1.0 (0.039)	0.2 (0.008)	1.9 (0.075)	3.5 (0.138)	1.4 (0.055)
A										3.3 (0.130)	3.8 (0.150)	1.9 (0.075)
B2 (S)										3.1 (0.122)	5.1 (0.201)	2.6 (0.102)
B	12 (0.472)	5.5 (0.217)	1.75 (0.069)	8 (0.315)	2 (0.079)	4 (0.157)	φ1.5 (0.059)	φ1.5 (0.059)	0.3 (0.012)	3.7 (0.146)	6.4 (0.252)	3.0 (0.118)
C									5.1 (0.201)	6.2 (0.244)	3.6 (0.142)	
D2 (T)									0.4 (0.016)	4.8 (0.189)	7.7 (0.303)	3.3 (0.130)
D									0.3 (0.012)	4.8 (0.189)	7.7 (0.303)	3.3 (0.130)

Leader and trailer

Unit: mm (inch)

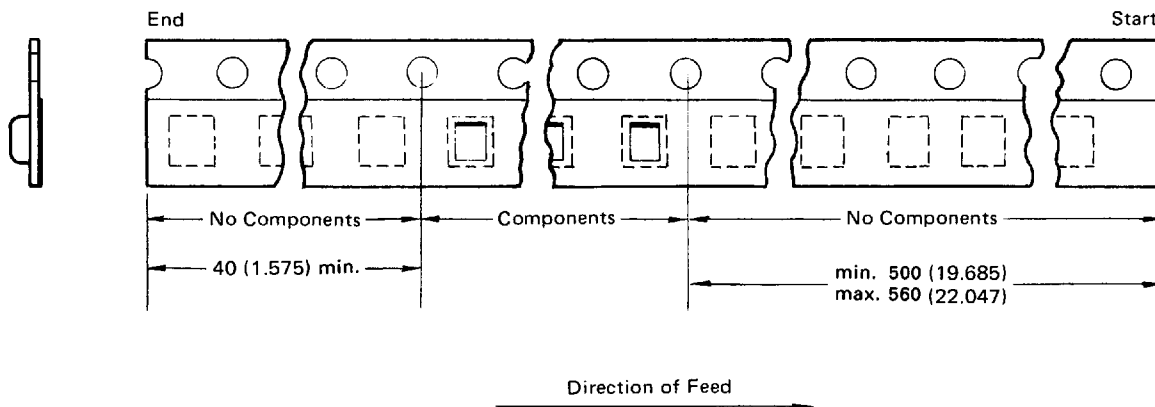

Reel

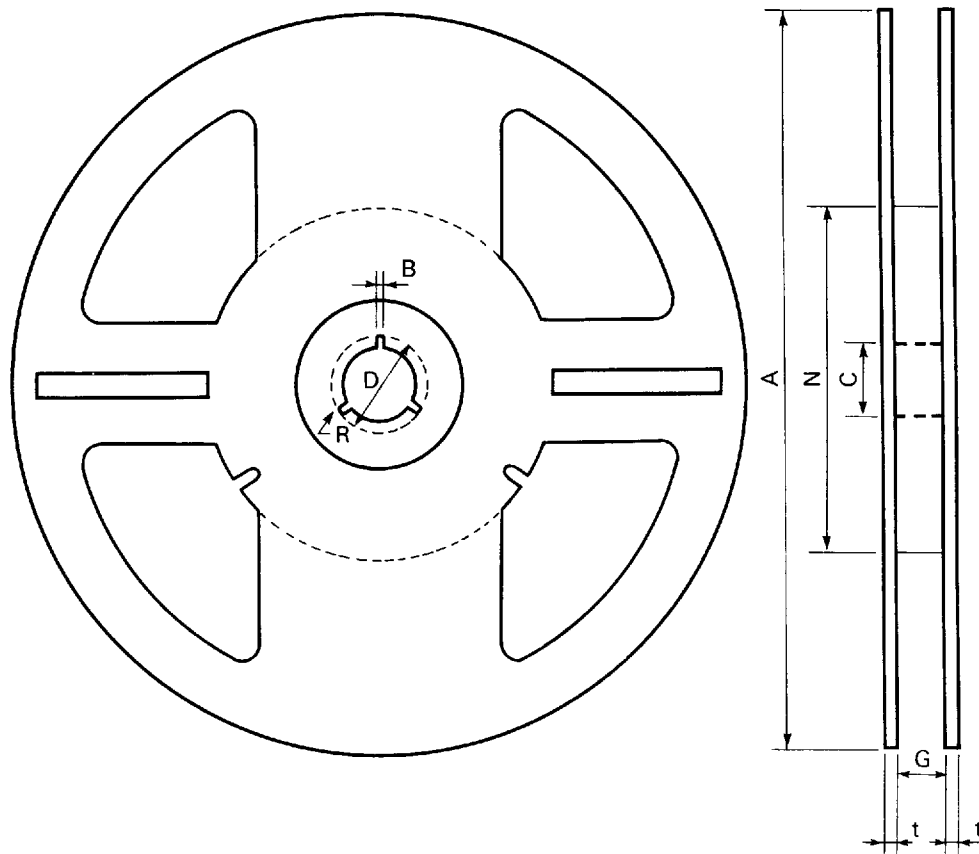

Unit: mm (inch)

Tape width	$A \pm 2$ (± 0.079)	N min.	$C \pm 0.5$ (± 0.020)	$D \pm 0.5$ (± 0.020)	$B \pm 0.5$ (± 0.020)	$G \pm 1.5$ (± 0.059)	$t \pm 0.5$ (± 0.020)	R
8 mm	$\phi 178$ (7)	$\phi 50$ (1.969)	$\phi 13$ (0.512)	$\phi 21$ (0.827)	2 (0.079)	10 (0.394)	2 (0.079)	1 (0.039)
12 mm						14 (0.551)		
8 mm	$\phi 330$ (13)	$\phi 80$ (3.150)	$\phi 13$ (0.512)	$\phi 21$ (0.827)	2 (0.079)	10 (0.394)	2 (0.079)	1 (0.039)
12 mm						14 (0.551)		

Case code	Dia. 178 mm	Dia. 330 mm
A2 (U)	3000	15000
A	2000	10000
B2 (S)	2000	5000
B	1500	5000
C, D2 (T), D	500	2500

[QUANTITY PER REEL]



Стандарт Электрон Связь

Мы молодая и активно развивающаяся компания в области поставок электронных компонентов. Мы поставляем электронные компоненты отечественного и импортного производства напрямую от производителей и с крупнейших складов мира.

Благодаря сотрудничеству с мировыми поставщиками мы осуществляем комплексные и плановые поставки широчайшего спектра электронных компонентов.

Собственная эффективная логистика и склад в обеспечивает надежную поставку продукции в точно указанные сроки по всей России.

Мы осуществляем техническую поддержку нашим клиентам и предпродажную проверку качества продукции. На все поставляемые продукты мы предоставляем гарантию .

Осуществляем поставки продукции под контролем ВП МО РФ на предприятия военно-промышленного комплекса России , а также работаем в рамках 275 ФЗ с открытием отдельных счетов в уполномоченном банке. Система менеджмента качества компании соответствует требованиям ГОСТ ISO 9001.

Минимальные сроки поставки, гибкие цены, неограниченный ассортимент и индивидуальный подход к клиентам являются основой для выстраивания долгосрочного и эффективного сотрудничества с предприятиями радиоэлектронной промышленности, предприятиями ВПК и научно-исследовательскими институтами России.

С нами вы становитесь еще успешнее!

Наши контакты:

Телефон: +7 812 627 14 35

Электронная почта: sales@st-electron.ru

Адрес: 198099, Санкт-Петербург,
Промышленная ул, дом № 19, литера Н,
помещение 100-Н Офис 331