

High Speed Optocoupler, 1 MBd, Schmitt Trigger

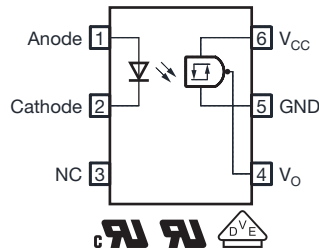

23030



DESIGN SUPPORT TOOLS

[click logo to get started](#)



DESCRIPTION

The VOH1016A is a single channel 1 MBd optocoupler utilizing a high efficient input LED coupled with an integrated optical photodiode IC detector. The detector has an open collector transistor output with Schmitt-Trigger functionality. The low turn-on threshold and low supply current together with a guaranteed common mode transient immunity of 10 kV/μs makes the VOH1016A to a perfect solution for galvanic noise isolation or to break up ground loops in digital applications. The wide power supply range up to 15 V enables isolated level shifting in applications using different voltage domains.

FEATURES

- High data rate 2 MHz (NRZ)
- Latch up and oscillation free
- Low turn-on threshold current 2 mA
- Logic compatible output
- Guaranteed on / off threshold hysteresis
- Wide supply voltage range 3 V to 15 V
- Minimum common mode transient immunity (CMTI) 10 kV/μs
- Material categorization: for definitions of compliance please see www.vishay.com/doc?99912



RoHS
COMPLIANT

APPLICATIONS

- Microprocessor system interface
- Ground loop elimination
- Galvanic noise isolation
- Serial bus systems
- Digital control power supply
- Signal level translation
- PLC, ATE input / output isolation
- Computer peripheral interface

AGENCY APPROVALS

- [UL 1577](#)
- [cUL 1577](#)
- [DIN EN 60747-5-5 \(VDE 0884-5\) available with option "V"](#)

ORDERING INFORMATION	
<div style="display: flex; justify-content: space-around; font-weight: bold; font-size: 1.2em;"> VOH1016A#-VT# </div> <div style="display: flex; justify-content: space-around; margin-top: 5px;"> </div> <div style="display: flex; justify-content: space-around; margin-top: 5px;"> PART NUMBER PACKAGE OPTION VDE OPTION TAPE AND REEL </div>	
AGENCY CERTIFIED / PACKAGE	CMTI (kV/μs)
UL, cUL	10
DIP-6	VOH1016AD
DIP-6, 400 mil	VOH1016AG
SMD-6	VOH1016AB-T
SMD-6, 180° oriented	VOH1016AB-T2
VDE, UL, cUL	10
DIP-6	VOH1016AD-V
DIP-6, 400 mil	VOH1016AG-V
SMD-6	VOH1016AB-VT
SMD-6, 180° oriented	VOH1016AB-VT2



TRUTH TABLE (positive logic)	
LED	OUTPUT
On	L
Off	H

ABSOLUTE MAXIMUM RATINGS ($T_{amb} = 25\text{ }^{\circ}\text{C}$, unless otherwise specified)				
PARAMETER	CONDITIONS	SYMBOL	VALUE	UNIT
INPUT				
Forward current		I_F	50	mA
Reverse voltage		V_R	6	V
Power dissipation		P_{diss}	120	mW
OUTPUT				
Supply voltage		V_{CC}	16	V
Output voltage		V_O	V_{CC}	V
Output current		I_O	50	mA
Power dissipation		P_{diss}	130	mW
COUPLER				
Power dissipation		P_{diss}	250	mW
Storage temperature		T_{stg}	-55 to +150	$^{\circ}\text{C}$
Operating temperature		T_{amb}	-40 to +100	$^{\circ}\text{C}$
Solder temperature	For 10 s	T_{sld}	260	$^{\circ}\text{C}$

Note

- Stresses in excess of the absolute maximum ratings can cause permanent damage to the device. Functional operation of the device is not implied at these or any other conditions in excess of those given in the operational sections of this document. Exposure to absolute maximum ratings for extended periods of the time can adversely affect reliability

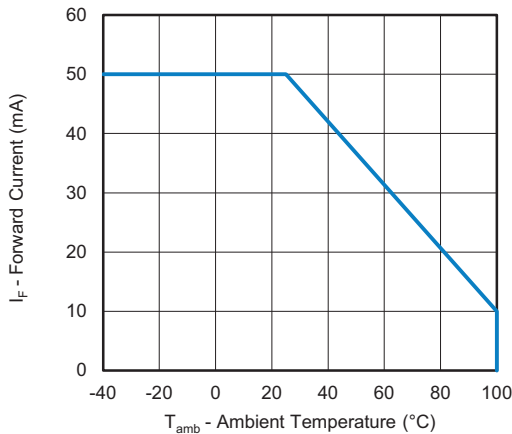

Fig. 1 - Forward Current vs. Ambient Temperature

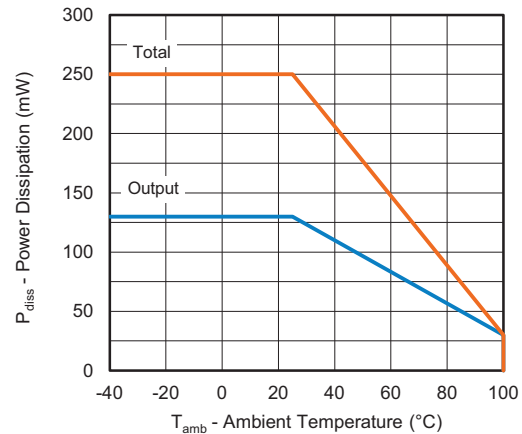

Fig. 2 - Power Dissipation vs. Ambient Temperature

ELECTRICAL CHARACTERISTICS ($T_{amb} = 25\text{ }^{\circ}\text{C}$, unless otherwise specified)						
PARAMETER	TEST CONDITION	SYMBOL	MIN.	TYP.	MAX.	UNIT
INPUT						
Forward voltage	$I_F = 4\text{ mA}$	V_F	-	1.1	1.4	V
	$I_F = 0.3\text{ mA}$		0.7	1.0	-	
Reverse current	$V_R = 3\text{ V}$	I_R	-	-	10	μA
Input capacitance	$f = 1\text{ MHz}, V_F = 0\text{ V}$	C_{IN}	-	30	250	pF
OUTPUT						
Supply voltage		V_{CC}	3	-	15	V
High level supply current	$I_F = 0\text{ mA}, V_{CC} = 5\text{ V}$	I_{CCH}	-	0.55	1.0	mA
Low level supply current	$I_F = 4\text{ mA}, V_{CC} = 5\text{ V}$	I_{CCL}	-	0.55	1.0	mA
High level output current	$V_{CC} = V_O = 15\text{ V}, I_F = 0\text{ mA}$	I_{OH}	-	-	100	μA
Low level output voltage	$V_{CC} = 5\text{ V}, I_F = 4\text{ mA}, I_{OL} = 16\text{ mA}$	V_{OL}	-	0.2	0.4	V
Turn-On threshold current	$V_{CC} = 5\text{ V}, R_L = 280\text{ }\Omega$	$I_{F(on)}$	-	0.65	2.0	mA
Turn-Off threshold current	$V_{CC} = 5\text{ V}, R_L = 280\text{ }\Omega$	$I_{F(off)}$	0.4	0.6	-	mA
Hysteresis ratio	$V_{CC} = 5\text{ V}, R_L = 280\text{ }\Omega$	$I_{F(off)}/I_{F(on)}$	0.5	0.9	0.95	

Note

- Minimum and maximum values are testing requirements. Typical values are characteristics of the device and are the result of engineering evaluation. Typical values are for information only and are not part of the testing requirements

SWITCHING CHARACTERISTICS ($T_{amb} = 25\text{ }^{\circ}\text{C}$, unless otherwise specified)							
PARAMETER	TEST CONDITION	SYMBOL	MIN.	TYP.	MAX.	UNIT	
Propagation delay time to high output level	$R_L = 280\text{ }\Omega, V_{CC} = 5\text{ V}, I_F = 4\text{ mA}$	t_{PLH}	-	0.25	2	μs	
Propagation delay time to low output level		t_{PHL}	-	0.05	1.2	μs	
Rise time		t_r	-	0.05	0.5	μs	
Fall time		t_f	-	0.04	0.5	μs	
Data rate				-	2	-	MHz

 Fig. 3 - Test Circuit for t_{on} , t_{off} , t_r , and t_f

COMMON MODE TRANSIENT IMMUNITY ($T_{amb} = 25\text{ }^{\circ}\text{C}$, unless otherwise specified)						
PARAMETER	TEST CONDITION	SYMBOL	MIN.	TYP.	MAX.	UNIT
Common mode transient immunity	$R_L = 270\ \Omega$, $V_{CC} = 5\ \text{V}$, $V_{CM} = 1000\ \text{V}$, $I_F = 0\ \text{mA}$	$ CM_H $	10	-	-	$\text{kV}/\mu\text{s}$
	$R_L = 270\ \Omega$, $V_{CC} = 5\ \text{V}$, $V_{CM} = 1000\ \text{V}$, $I_F = I_{F(on)}\ (\text{max.})$	$ CM_L $	10	-	-	$\text{kV}/\mu\text{s}$



Fig. 4 - Test Circuit for Common Mode Transient Immunity

SAFETY AND INSULATION RATINGS ($T_{amb} = 25\text{ }^{\circ}\text{C}$, unless otherwise specified)				
PARAMETER	TEST CONDITION	SYMBOL	VALUE	UNIT
Comparative tracking index	Insulation group IIIa	CTI	175	
Maximum rated withstanding isolation voltage	According to UL1577, $t = 1\ \text{min}$	V_{ISO}	5000	V_{RMS}
Maximum transient isolation voltage	According to DIN EN 60747-5-5	V_{IOTM}	6000	V_{peak}
Maximum repetitive peak isolation voltage	According to DIN EN 60747-5-5	V_{IORM}	630	V_{peak}
Isolation resistance	$T_{amb} = 25\text{ }^{\circ}\text{C}$, $V_{IO} = 500\ \text{V}$	R_{IO}	10^{12}	Ω
	$T_{amb} = 100\text{ }^{\circ}\text{C}$, $V_{IO} = 500\ \text{V}$	R_{IO}	10^{11}	Ω
Output safety power		P_{SO}	150	mW
Input safety current		I_{SI}	20	mA
Input safety temperature		T_S	175	$^{\circ}\text{C}$
Creepage distance			> 7	mm
Clearance distance			> 7	mm
Insulation thickness		DTI	> 0.4	mm

TYPICAL CHARACTERISTICS ($T_{amb} = 25\text{ }^{\circ}\text{C}$, unless otherwise specified)

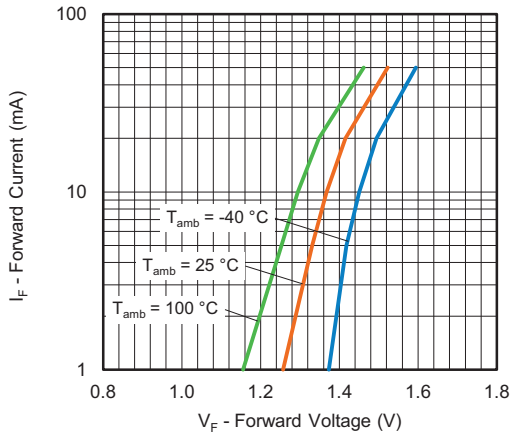

Fig. 5 - Forward Current vs. Forward Voltage

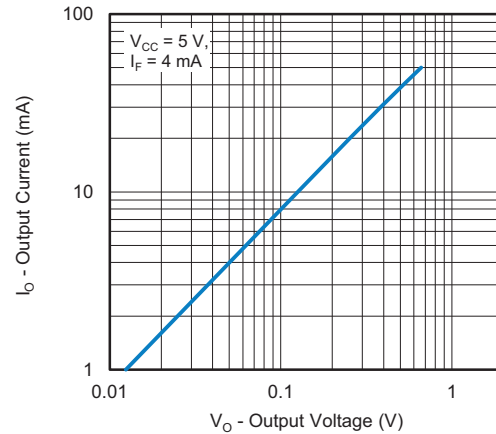

Fig. 8 - Output Current vs. Output Voltage

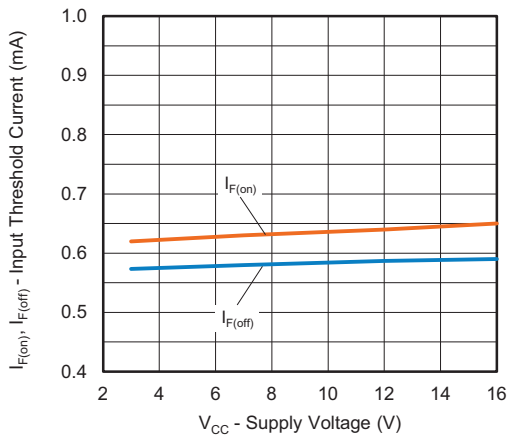

Fig. 6 - Input Threshold Current vs. Supply Voltage

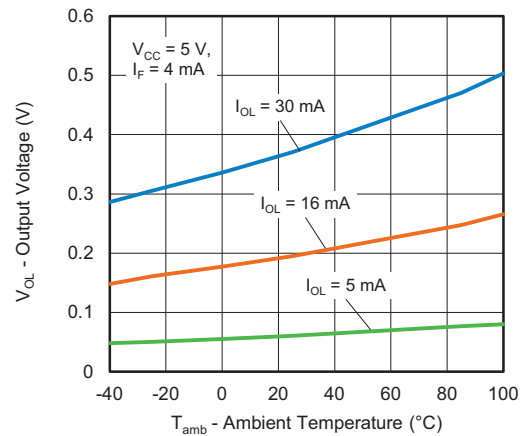

Fig. 9 - Output Voltage vs. Ambient Temperature

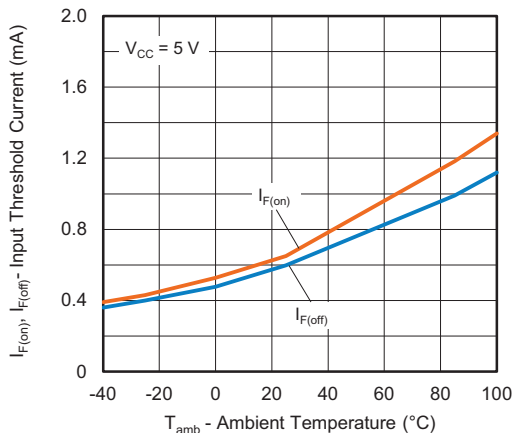

Fig. 7 - Input Threshold Current vs. Ambient Temperature

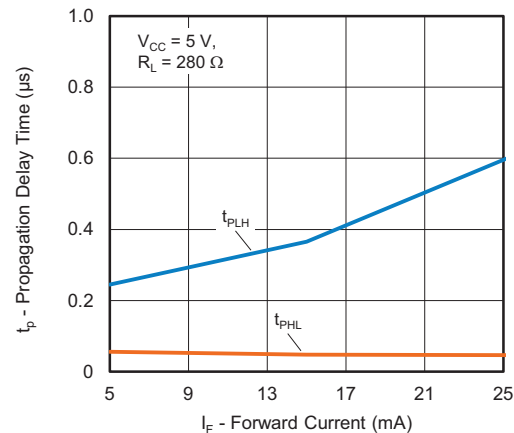

Fig. 10 - Propagation Delay Time vs. Forward Current



Fig. 11 - Propagation Delay Time vs. Load Resistance



Fig. 12 - High Level Supply Current vs. Supply Voltage



Fig. 13 - Low Level Supply Current vs. Supply Voltage



PACKAGE DIMENSIONS (in millimeters)

DIP-6



Fig. 1

DIP-6, 400 mil



Fig. 2

SMD-6

Fig. 3

PACKAGE MARKING

Fig. 14 - Example of VOH1016AB-VT

Notes

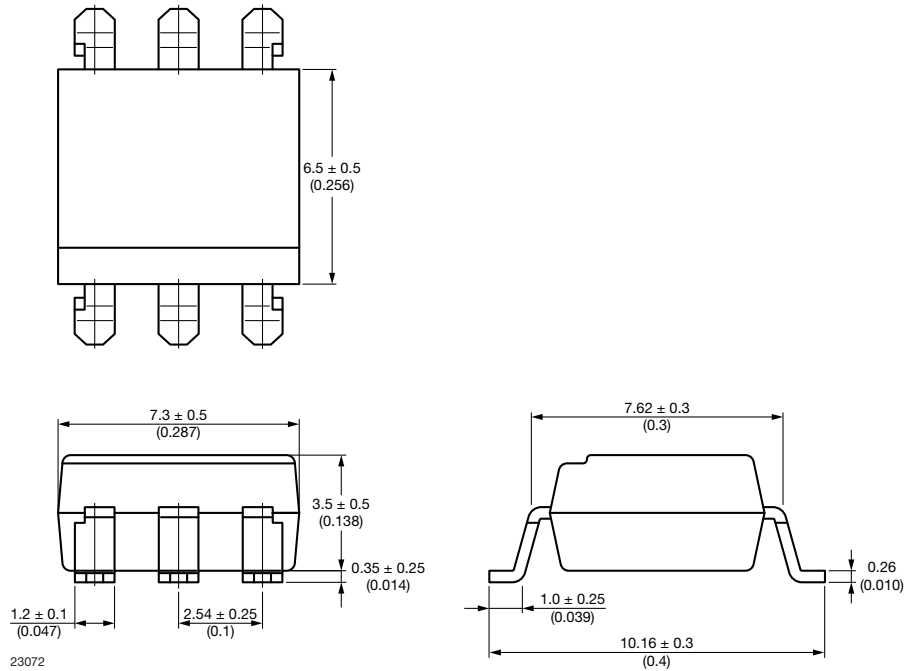
- “YWW” is the date code marking (Y = year code, WW = week code)
- VDE logo is only marked on option “V” parts
- Tape and reel suffix (T) is not part of the package marking

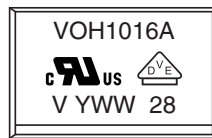

PACKING INFORMATION (in millimeters)

DEVICES PER TUBES			
TYPE	UNITS/TUBE	TUBES/BOX	UNITS/BOX
DIP-6	50	40	2000
DIP-6, 400 mil	50	40	2000

Tape SMD-6

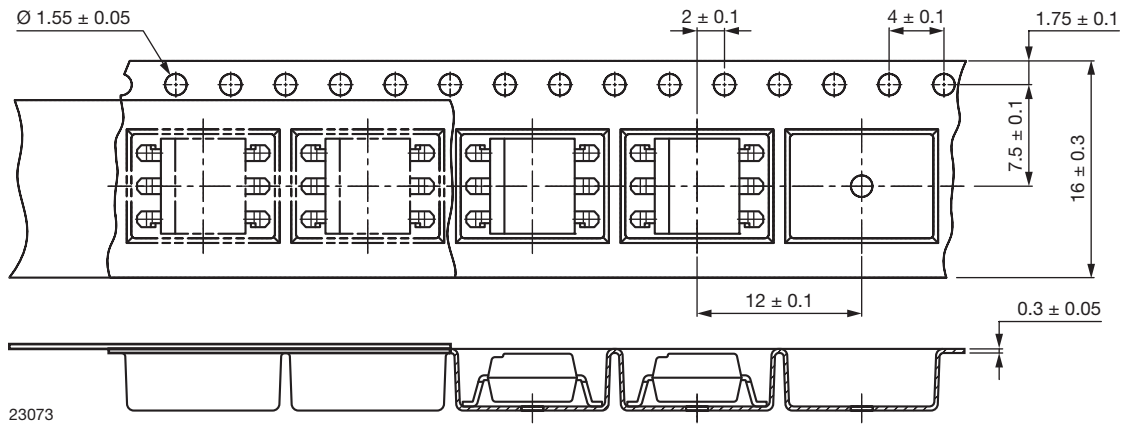

Fig. 15 - Tape and Reel Packaging (1000 pieces on reel)

Tape SMD-6, 180° orientation



Fig. 16 - Tape and Reel Packaging (1000 pieces on reel)

Reel

Fig. 17 - Tape and Reel Shipping Medium

SOLDER PROFILES
IR Reflow Soldering (JEDEC® J-STD-020C compliant)

One time soldering reflow is recommended within the condition of temperature and time profile shown below. Do not solder more than three times.

PROFILE ITEM	CONDITIONS
Preheat	
- Temperature minimum ($T_{S \text{ min.}}$)	150 °C
- Temperature maximum ($T_{S \text{ max.}}$)	200 °C
- Time (min. to max.) (t_S)	90 s ± 30 s
Soldering zone	
- Temperature (T_L)	217 °C
- Time (t_L)	60 s
Peak temperature (T_p)	260 °C
Ramp-up rate	3 °C/s max.
Ramp-down rate	3 °C/s to 6 °C/s



Fig. 4



Wave Soldering (JEDEC JESD22-A111 compliant)

One time soldering is recommended within the condition of temperature.

Temperature: 260 °C + 0 °C / - 5 °C

Time: 10 s

Preheat temperature: 25 °C to 140 °C

Preheat time: 30 s to 80 s

Hand Soldering by Soldering Iron

Allow single lead soldering in every single process. One time soldering is recommended.

Temperature: 380 °C + 0 °C / - 5 °C

Time: 3 s max.

HANDLING AND STORAGE CONDITIONS

ESD level: HBM class 2

Floor life: unlimited

Conditions: $T_{amb} < 30\text{ °C}$, RH < 85 %

Moisture sensitivity level 1, according to J-STD-020

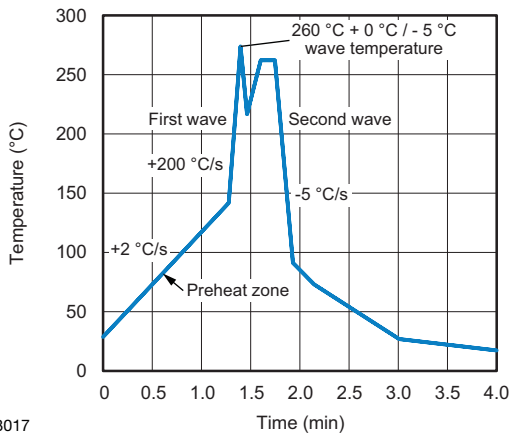

Fig. 5

23017



Disclaimer

ALL PRODUCT, PRODUCT SPECIFICATIONS AND DATA ARE SUBJECT TO CHANGE WITHOUT NOTICE TO IMPROVE RELIABILITY, FUNCTION OR DESIGN OR OTHERWISE.

Vishay Intertechnology, Inc., its affiliates, agents, and employees, and all persons acting on its or their behalf (collectively, "Vishay"), disclaim any and all liability for any errors, inaccuracies or incompleteness contained in any datasheet or in any other disclosure relating to any product.

Vishay makes no warranty, representation or guarantee regarding the suitability of the products for any particular purpose or the continuing production of any product. To the maximum extent permitted by applicable law, Vishay disclaims (i) any and all liability arising out of the application or use of any product, (ii) any and all liability, including without limitation special, consequential or incidental damages, and (iii) any and all implied warranties, including warranties of fitness for particular purpose, non-infringement and merchantability.

Statements regarding the suitability of products for certain types of applications are based on Vishay's knowledge of typical requirements that are often placed on Vishay products in generic applications. Such statements are not binding statements about the suitability of products for a particular application. It is the customer's responsibility to validate that a particular product with the properties described in the product specification is suitable for use in a particular application. Parameters provided in datasheets and / or specifications may vary in different applications and performance may vary over time. All operating parameters, including typical parameters, must be validated for each customer application by the customer's technical experts. Product specifications do not expand or otherwise modify Vishay's terms and conditions of purchase, including but not limited to the warranty expressed therein.

Except as expressly indicated in writing, Vishay products are not designed for use in medical, life-saving, or life-sustaining applications or for any other application in which the failure of the Vishay product could result in personal injury or death. Customers using or selling Vishay products not expressly indicated for use in such applications do so at their own risk. Please contact authorized Vishay personnel to obtain written terms and conditions regarding products designed for such applications.

No license, express or implied, by estoppel or otherwise, to any intellectual property rights is granted by this document or by any conduct of Vishay. Product names and markings noted herein may be trademarks of their respective owners.



Стандарт Электрон Связь

Мы молодая и активно развивающаяся компания в области поставок электронных компонентов. Мы поставляем электронные компоненты отечественного и импортного производства напрямую от производителей и с крупнейших складов мира.

Благодаря сотрудничеству с мировыми поставщиками мы осуществляем комплексные и плановые поставки широчайшего спектра электронных компонентов.

Собственная эффективная логистика и склад в обеспечивает надежную поставку продукции в точно указанные сроки по всей России.

Мы осуществляем техническую поддержку нашим клиентам и предпродажную проверку качества продукции. На все поставляемые продукты мы предоставляем гарантию .

Осуществляем поставки продукции под контролем ВП МО РФ на предприятия военно-промышленного комплекса России , а также работаем в рамках 275 ФЗ с открытием отдельных счетов в уполномоченном банке. Система менеджмента качества компании соответствует требованиям ГОСТ ISO 9001.

Минимальные сроки поставки, гибкие цены, неограниченный ассортимент и индивидуальный подход к клиентам являются основой для выстраивания долгосрочного и эффективного сотрудничества с предприятиями радиоэлектронной промышленности, предприятиями ВПК и научно-исследовательскими институтами России.

С нами вы становитесь еще успешнее!

Наши контакты:

Телефон: +7 812 627 14 35

Электронная почта: sales@st-electron.ru

Адрес: 198099, Санкт-Петербург,
Промышленная ул, дом № 19, литера Н,
помещение 100-Н Офис 331