

ACT4751EVK1-101 User's Guide

Description

This document describes the characteristics and operation of the Active Semi ACT4751EVK1-101 evaluation kit (EVK). It provides setup and operation instructions, schematic, layout, BOM, and test data. This EVK demonstrates the ACT4751 power management IC. Other ACT4751Qlxxx options can be evaluated on this EVK by replacing the IC and any other necessary components.

Features

The EVK can be used as a standalone board if desired. However, to access the internal registers and to take full advantage of the IC's capability, the user must connect the EVK to a PC with Active Semi's USB-TO-I2C interface dongle and use the GUI software. The EVK provides full access to the each converter's input and output voltage, as well as all the digital control signals. This gives the user the flexibility to configure the EVK to match their real world system.

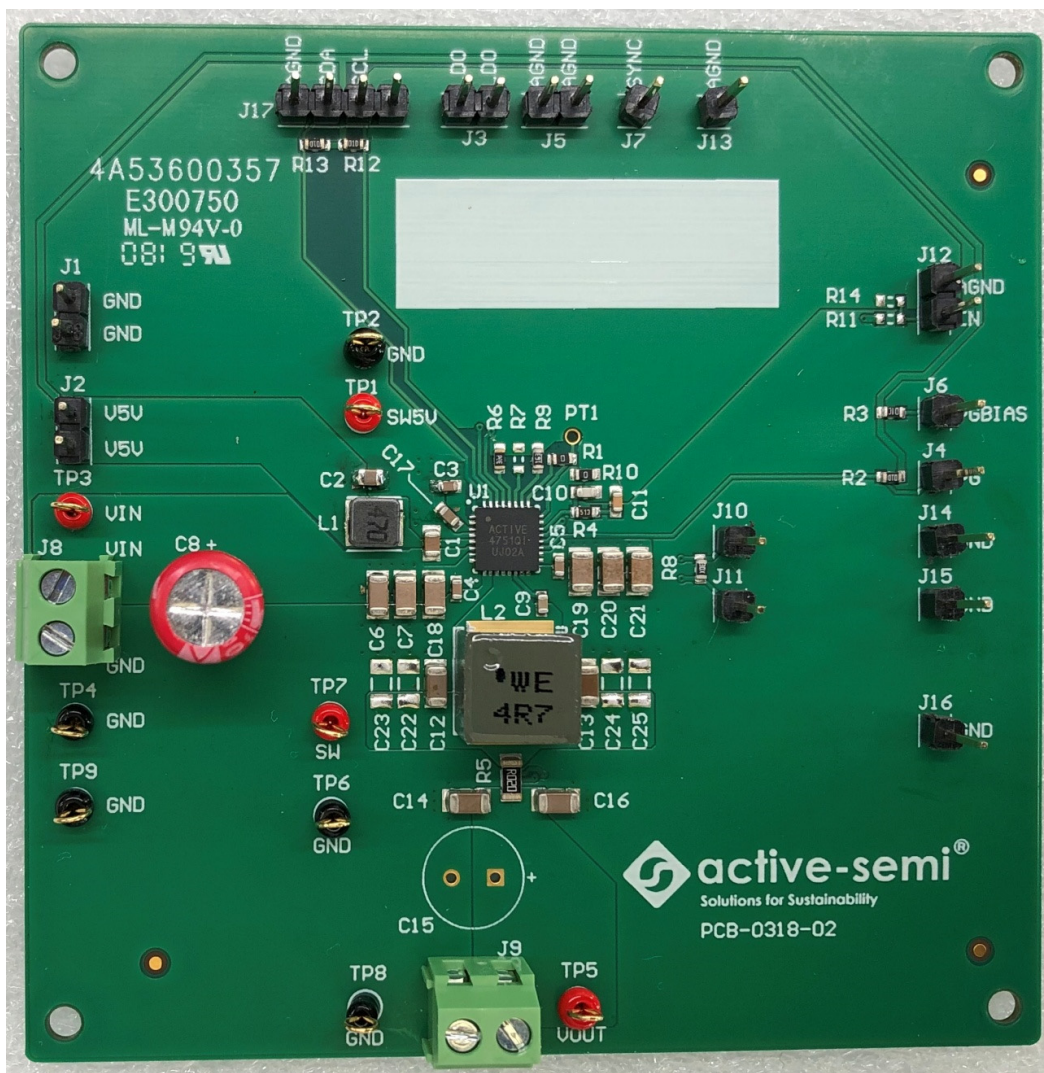

Figure 1. EVK Picture

EVK Contents

The ACT4751EVK1-101 evaluation kit comes with the following items:

1. EVK assembly
2. USB-TO-I2C dongle
 - a. Dongle
 - b. Custom 4-pin connector that connects the USB-TO-I2C dongle to the EVK assembly

Required Equipment

ACT4751EVK1-101

USB-TO-I2C Dongle

Power supply → 4~40V @ 6A for full power operation

Oscilloscope → 100MHz, 4 channels

Digital Multi-meters (DMM)

Windows compatible PC with spare USB port.

Hardware Setup

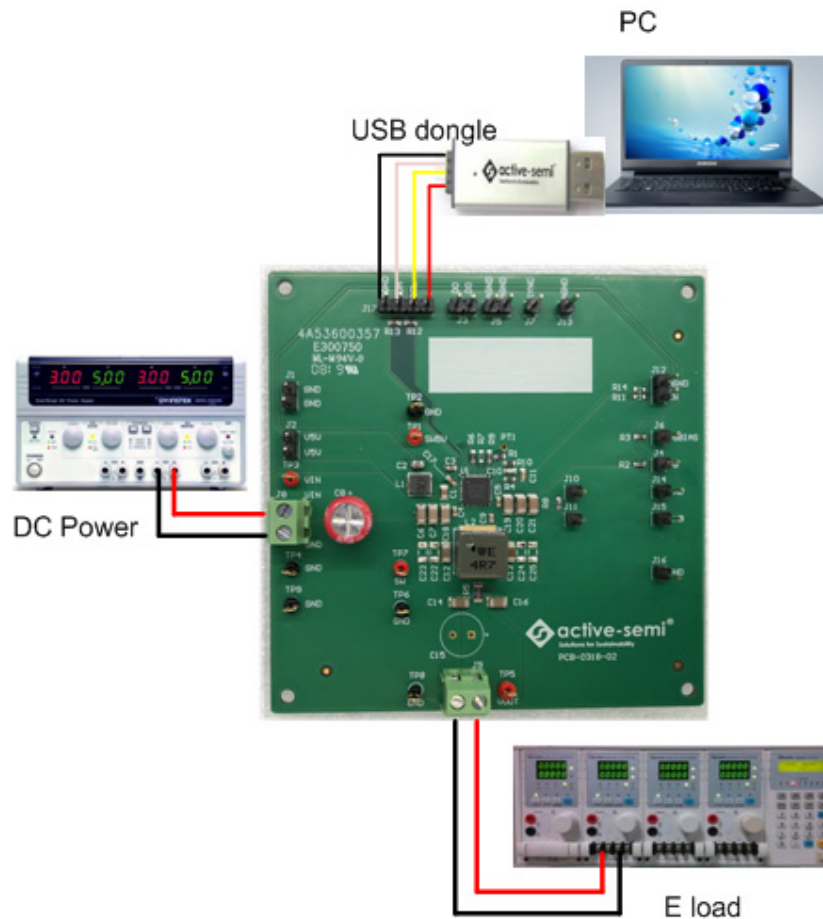

Figure 2. EVK Setup

Quick Start

Hardware Connections

Refer to Figure 2 for hardware connections.

1. Connect a DC power supply to J8. Please ensure the correct power supply polarity.
2. Connect an E-Load to J9.
3. Connect Digital Multi-Meters to VIN and VOUT to monitor the input voltage and output voltages.
4. Add a digital Multi-Meter in series with VIN and VOUT if you want to observe input and output current.
5. Be careful to keep the input voltage within the specifications.
6. Optional – Connect the EVK to the PC with the USB dongle.

GUI Setup (optional)

1. Refer to the end of this document for detailed instructions to install the ACT475x GUI.
2. Connect the USB-TO-I2C dongle to the computer via a USB cable.
3. Connect the USB-TO-I2C dongle to the EVK J17 connector. Refer to Figure 3 to ensure the correct polarity of the connection. As a guide, use the “Active-Semi” logo on the top of the dongle so the black wire is connected to the Dongle GND pin.

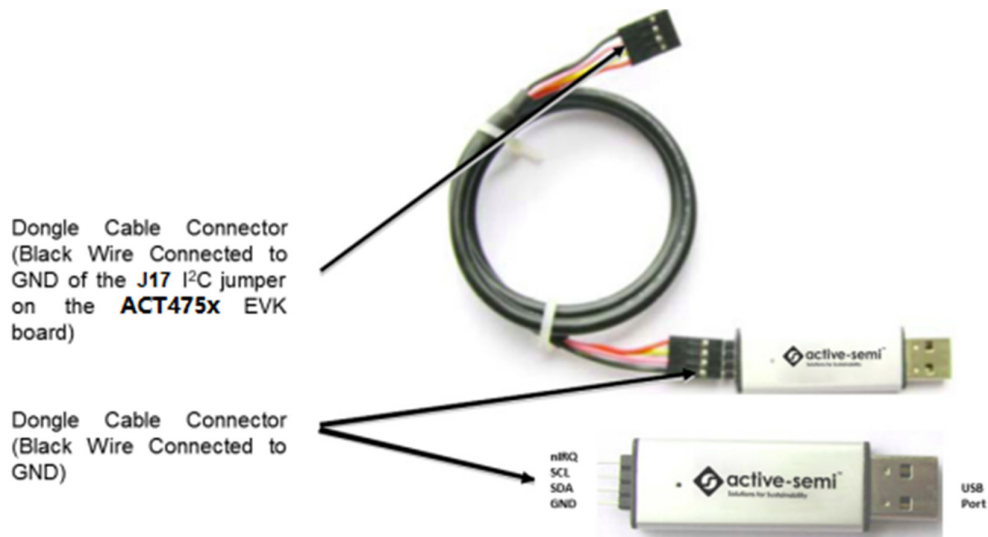

Figure 3. USB-TO-I2C Dongle Connection

Recommended Operating Conditions

The ACT4751EVK1-101 is designed for a 4V-40V input voltage. The maximum operating voltage is determined by the IC's maximum input voltage rating. The minimum operating voltage is determined by the converter's minimum input voltage. The maximum output current is configured by the CMI and external components.

Table 1. Recommended Operating Conditions

| Parameter | Description | Min | Typ | Max | Unit |
|-----------|----------------------------------|-----|-----|-----|------|
| VIN | Input voltage | 4 | - | 40 | V |
| VOUT | Main-buck output voltage | 3 | - | 24 | V |
| V5V | Mini-buck output voltage | | 5 | | V |
| Iv5V_max | Mini-buck maximum output current | | 300 | | mA |
| Iout_max | Main-buck maximum output current | | 4 | | A |

EVK Operation

Turn On the Evaluation Board

After the power source and E-Load are connected to the evaluation board per the required connections, the EVK can be powered for operation. Perform the following steps to turn on the board.

1. Ensure that the power supply connected to VIN (J8) is >4V and <40V.
2. Turn on power supply.
3. Apply the load.
4. Remove the shorting jumper from J12 to enable output. Replace the jumper to disable the output.

Output Current Limit – The ACT4751EVK1-101 output current limit is set to 4A. This is a function of the 20mΩ current sense resistor, R5, the 16kΩ ILIM resistor, R9, and the I²C Output Current Limit bits, which are set to 100uA by default. The ACT4751 integrates a digital-to-analog converter (ILIM DAC) for the purpose of generating the reference signal used by the Current Limit block. The ILIM DAC generates an output current at the ILIM pin. The output current limit is easily changed by modifying any of these three parameters. The easiest way to change the output current limit is with the ILIM DAC field in the GUI.

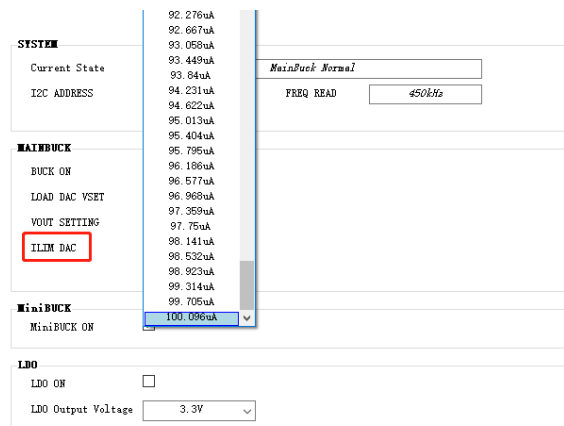

Output Voltage Setting

The default output voltage can be changed by I²C using the VOUT SETTING field in the GUI.

| | | |
|---------------------|-----------------------------------|-----------------------------------------------|
| SYSTEM | 5.1125V | |
| Current State | 5.125V | <i>MainPuck Normal</i> |
| I2C ADDRESS | 5.1375V | FREQ READ <input type="text" value="450kHz"/> |
| | 5.15V | |
| | 5.1625V | |
| | 5.175V | |
| | 5.1875V | |
| | 5.2V | |
| | 5.2125V | |
| MAINBUCK | 5.225V | |
| BUCK ON | 5.2375V | |
| | 5.25V | |
| LOAD DAC VSET | 5.2625V | |
| VOUT SETTING | 5.275V | |
| ILIM DAC | 5.2875V | |
| | 5.3V | |
| | 5.3125V | |
| | 5.325V | |
| | 5.3375V | |
| | 5.35V | |
| MiniBUCK | 5.3625V | |
| MiniBUCK ON | | |
| LDO | | |
| LDO ON | <input type="checkbox"/> | |
| LDO Output Voltage | <input type="text" value="3.3V"/> | |

Additional Programmable Functionality

The ACT475x contains many additional programmable parameters. Refer to the ACT4751 datasheet for additional functionality and default I²C register values.

Test Results

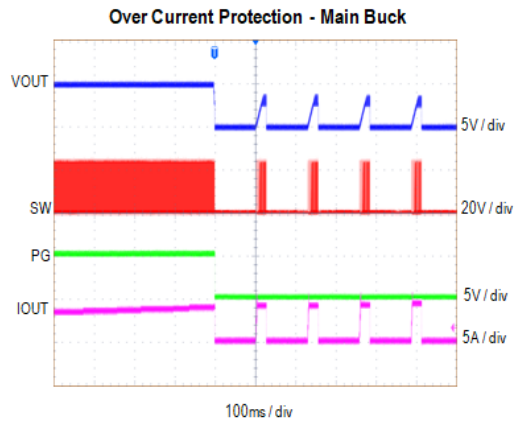
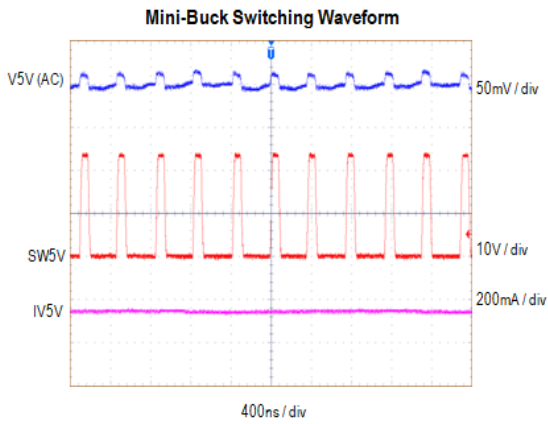
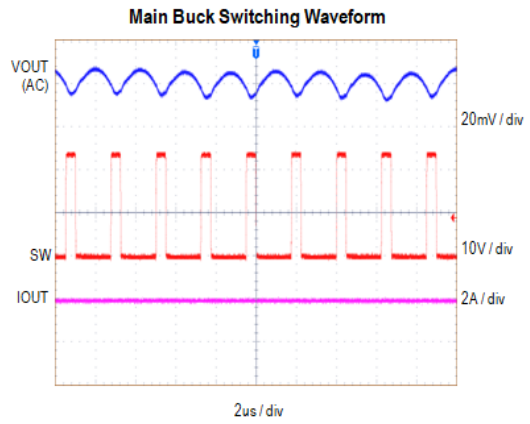
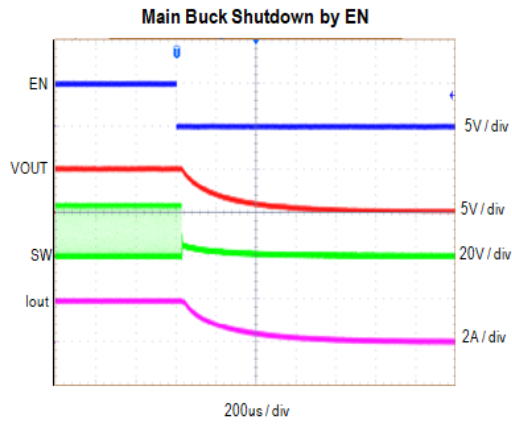
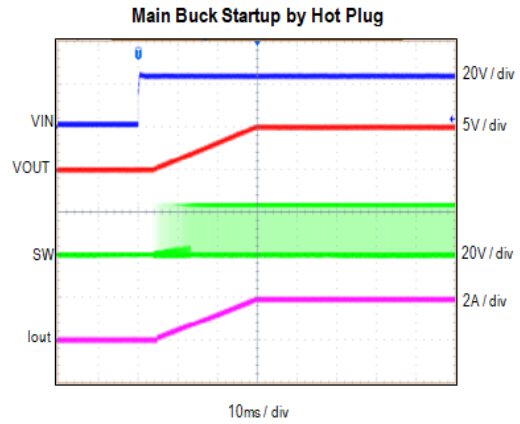
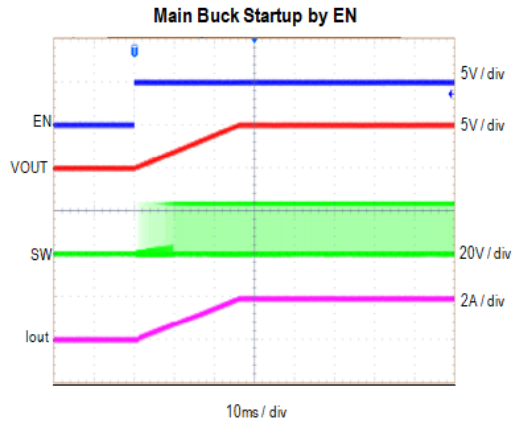

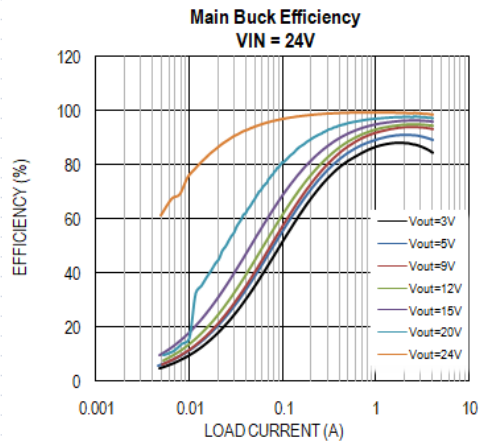
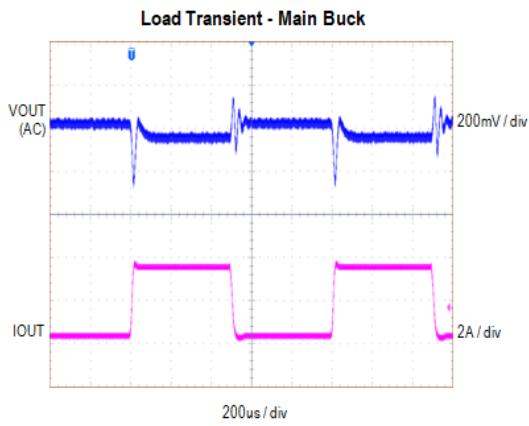
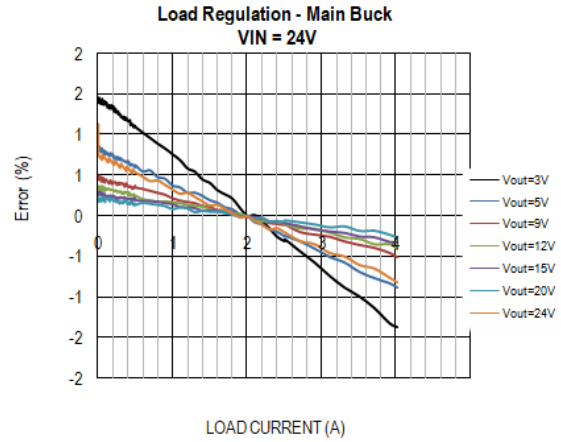
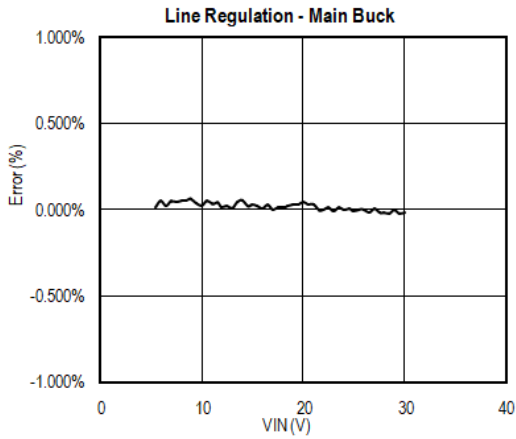

Schematic

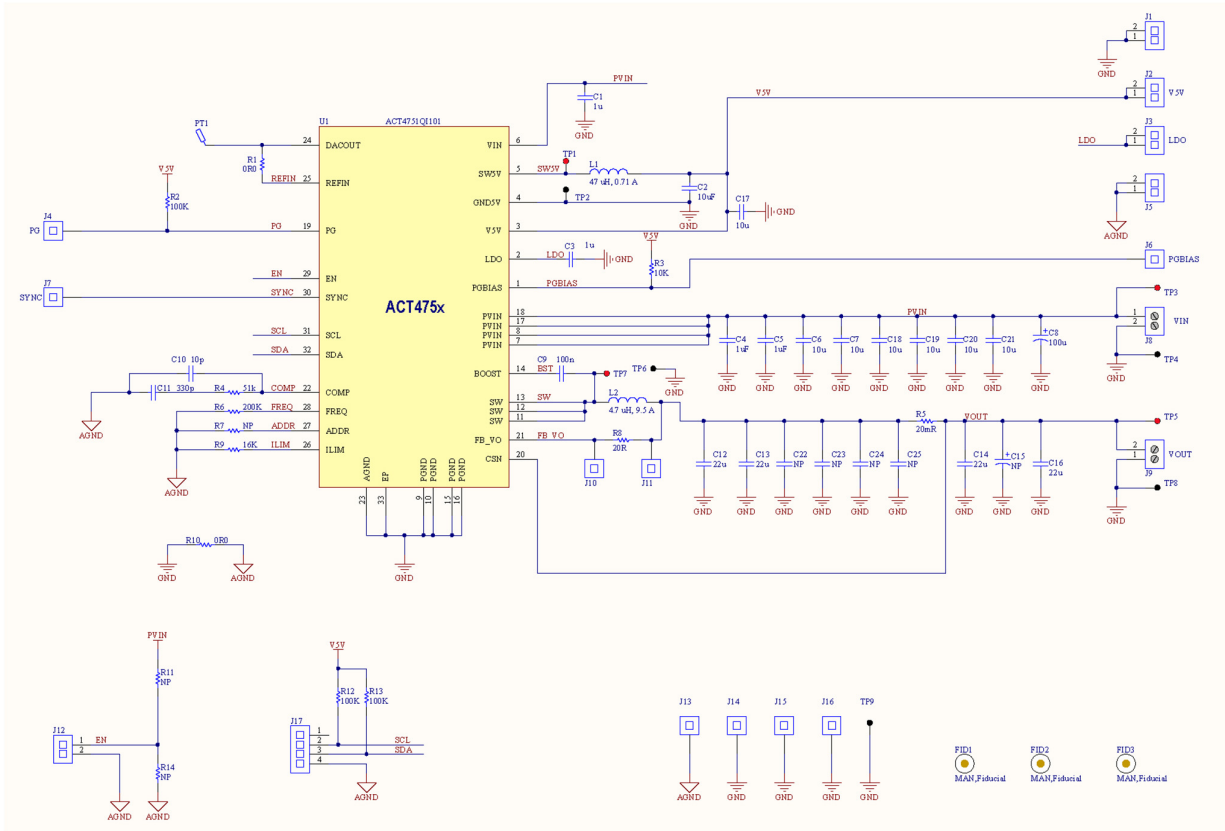

Figure 4. Schematic

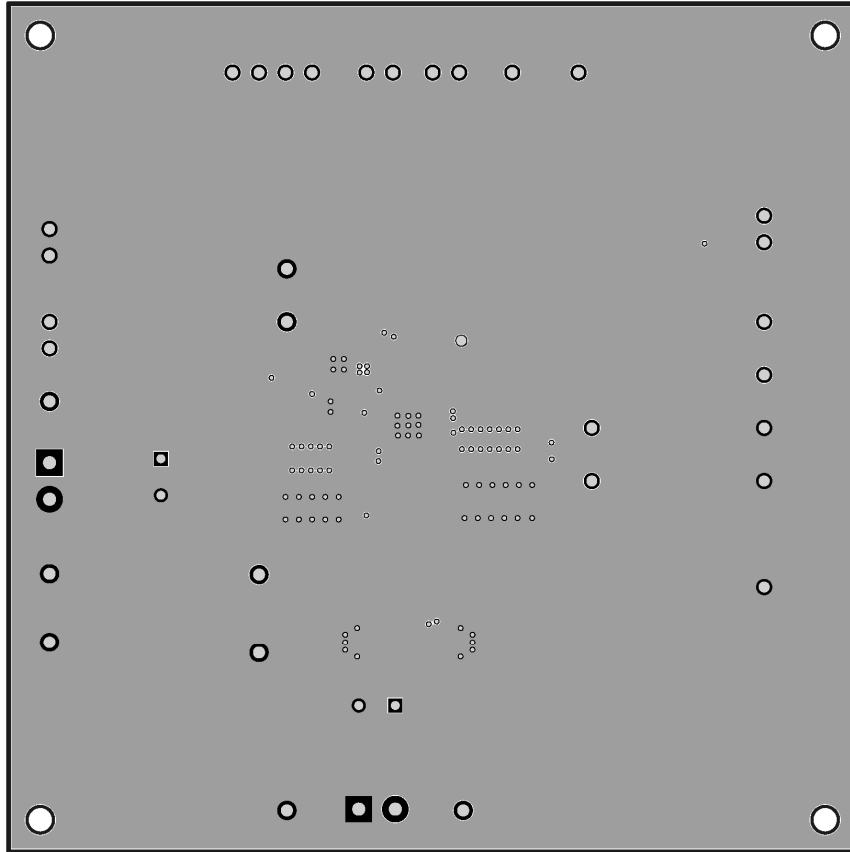

Figure 6. Layout Layer2 - GND

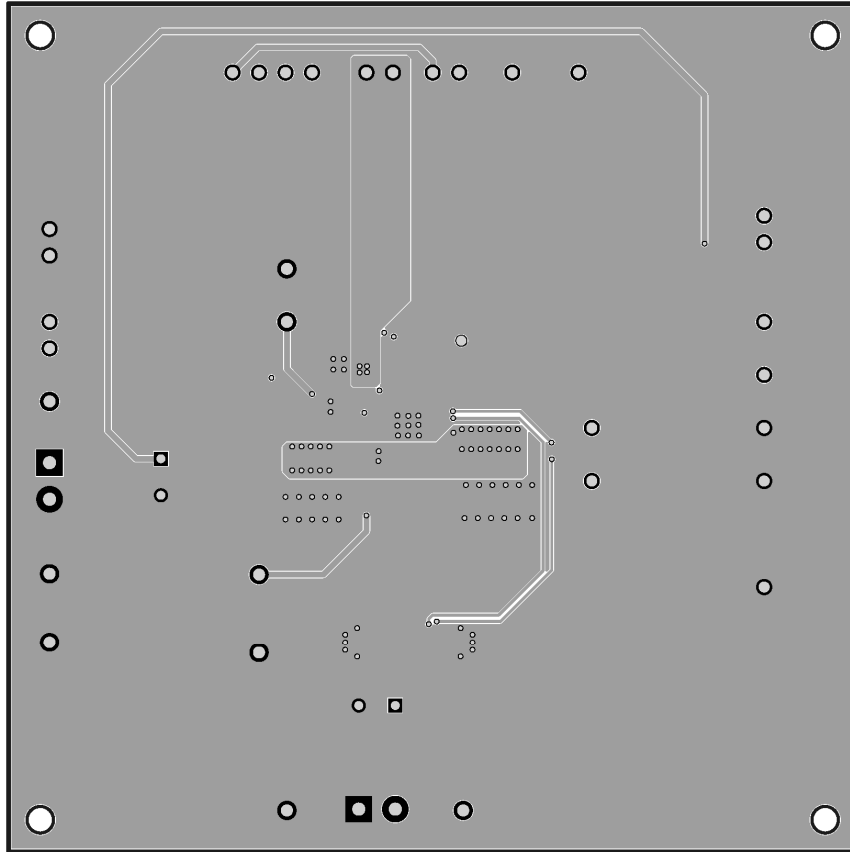

Figure 7. Layout Layer 3 -VCC

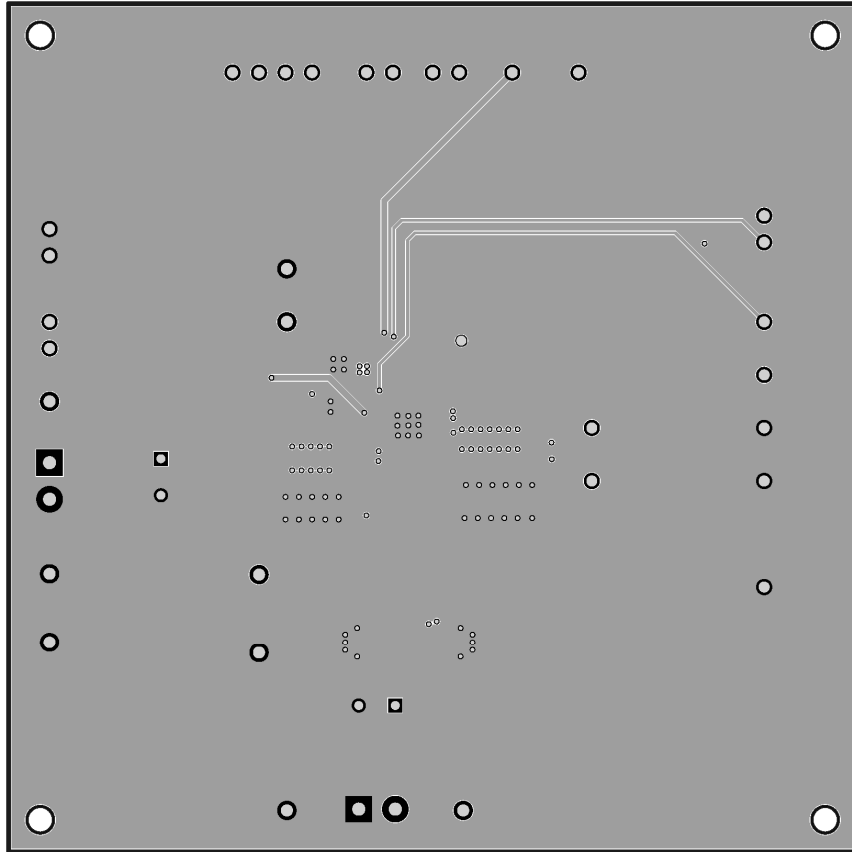







Figure 8. Layout Bottom Layer

Bill of Materials
Table 2. ACT4751EVK1-101 BOM

| Item | Ref Des | QTY | Description | Package | MFR | Part Number |
|------|------------------------------------------|-----|-----------------------------------------|-------------|------------------|----------------------|
| 1 | C1 | 1 | Cap, Ceramic, 1uF, 50V, 20%, X5R | 0805 | Wurth Elektronik | std |
| 2 | C2 | 1 | Cap, Ceramic, 10uF, 10V, 20%, X5R | 0805 | Wurth Elektronik | 885012107010 |
| 3 | C3 | 1 | Cap, Ceramic, 1uF, 10V, 20%, X5R | 0603 | Wurth Elektronik | std |
| 4 | C4, C5 | 2 | Cap, Ceramic, 1uF, 50V, 20%, X5R | 0603 | Wurth Elektronik | std |
| 5 | C6, C7, C18, C19, C20, C21 | 6 | Cap, Ceramic, 10uF, 50V, 10%, X5R | 1206 | TDK | CGA5L3X5R1H106K160AB |
| 6 | C8 | 1 | Cap, Aluminium Electrolytic, 100uF, 50V | 8x11.5mm | Wurth Elektronik | 860010674014 |
| 7 | C9 | 1 | Cap, Ceramic, 100nF, 25V, 20%, X5R | 0603 | Wurth Elektronik | std |
| 8 | C10 | 1 | Cap, Ceramic, 10pF, 50V, 20%, X5R | 0603 | Wurth Elektronik | std |
| 9 | C11 | 1 | Cap, Ceramic, 330pF, 50V, 20%, X5R | 0603 | Wurth Elektronik | std |
| 10 | C12, C13, C14, C16 | 4 | Cap, Ceramic, 22uF, 35V, 20%, X5R | 1206 | TDK | C3216X5R1V226M160AC |
| 11 | C15 | 0 | NP | 8x11.5mm | Wurth Elektronik | 860010674014 |
| 12 | C17 | 1 | Cap, Ceramic, 10uF, 25V, 10%, X5R | 0603 | Wurth Elektronik | std |
| 13 | C22, C23, C24, C25 | 0 | NP | 1206 | TDK | C3216X5R1V226M160AC |
| 14 | J1, J2, J3, J5, J12 | 5 | Header, 2pin, 100mil | | Wurth Elektronik | 61300211121 |
| 15 | J4, J6, J7, J10, J11, J13, J14, J15, J16 | 9 | Header, 1pin, 100mil | | Wurth Elektronik | 61300111121 |
| 16 | J8, J9 | 2 | Entry modular, 2pin | | Wurth Elektronik | 691214110002S |
| 17 | J17 | 1 | Header, 4 pin, 100mil | | Wurth Elektronik | 61300411121 |
| 18 | L1 | 1 | Inductor, 47uH, 0.71A, SMD | 4mmx4mm | Wurth Elektronik | 74404043470A |
| 19 | L2 | 1 | Inductor, 4.7uH, 9.5A, SMD | 8.8mmx8.8mm | Wurth Elektronik | 74439358047 |
| 20 | R1, R10 | 2 | Res, 0Ω, 1% | 0603 | std | std |
| 21 | R2, R12, R13 | 3 | Res, 100kΩ, 1% | 0603 | std | std |
| 22 | R3 | 1 | Res, 10kΩ, 1% | 0603 | std | std |
| 23 | R4 | 1 | Res, 51kΩ, 1% | 0603 | std | std |
| 24 | R7, R11, R14 | 0 | NP | 0603 | NP | std |
| 25 | R5 | 1 | Resistor, 20mΩ, 1%, 1W | 1206 | SART | SMF12MAFR020T |
| 26 | R6 | 1 | Res, 200kΩ, 1% | 0603 | std | std |
| 27 | R8 | 1 | Res, 20Ω, 1% | 0603 | std | std |
| 28 | R9 | 1 | Res, 16kΩ, 1% | 0603 | std | std |
| 29 | TP1, TP3, TP5, TP7 | 4 | Test Point, Red | | Keystone | TESTPOINT 5000 |
| 30 | TP2, TP4, TP6, TP8, TP9 | 5 | Test Point, Black | | Keystone | TESTPOINT 5001 |
| 31 | U1 | 1 | ACT4751 | QFN32-5X5 | Active-semi | ACT4751QI101 |
| 32 | -- | 1 | Multi-Jumper with Test Point, 100mil | | Wurth Elektronik | 60910213421 |
| 33 | -- | 1 | PCB, ACT475XEVK | n/a | n/a | PCB-0318-02 |

GUI Installation

1. Get GUI files from the Active Semi website
2. Plug the USB-TO-I2C dongle into a free USB port.
3. Follow the instructions in the “How to install driver for dongle” folder.
4. Double click on the ActiveGUI.exe to start the ACT475x GUI.

| | | | |
|--------------------------------------------------------------------------------------------------------------------------|-----------------|---------------------|----------|
|  Driver | 2018/8/28 16:21 | 文件夹 | |
|  How to install driver for dongle | 2018/8/28 16:21 | 文件夹 | |
|  ACT475x GUI guidelines.pptx | 2018/8/1 16:27 | Microsoft Office... | 317 KB |
|  ACT475x_REV0.0.cpmu | 2018/7/25 18:44 | CPMU 文件 | 40 KB |
|  Active Semi GUI and Dongle Driver I... | 2017/3/30 16:24 | Adobe Acrobat ... | 1,257 KB |
|  ActiveGUI.exe | 2017/10/2 11:12 | 应用程序 | 5,953 KB |

GUI Overview

The GUI has 2 basic function buttons allocated in top-left of the Tool Bar which are Read and Write I²C. The GUI contains 2 setting modes: Basic Mode and Advanced Mode. In Basic Mode screen it displays basic user programmable configuration options are programmed using the drop-down boxes or check boxes. Advanced Mode contains the button text for changing setting for every single bit.

Basic Mode

The following figure shows the GUI in basic mode. This mode allows the user to easily change one or more IC settings.

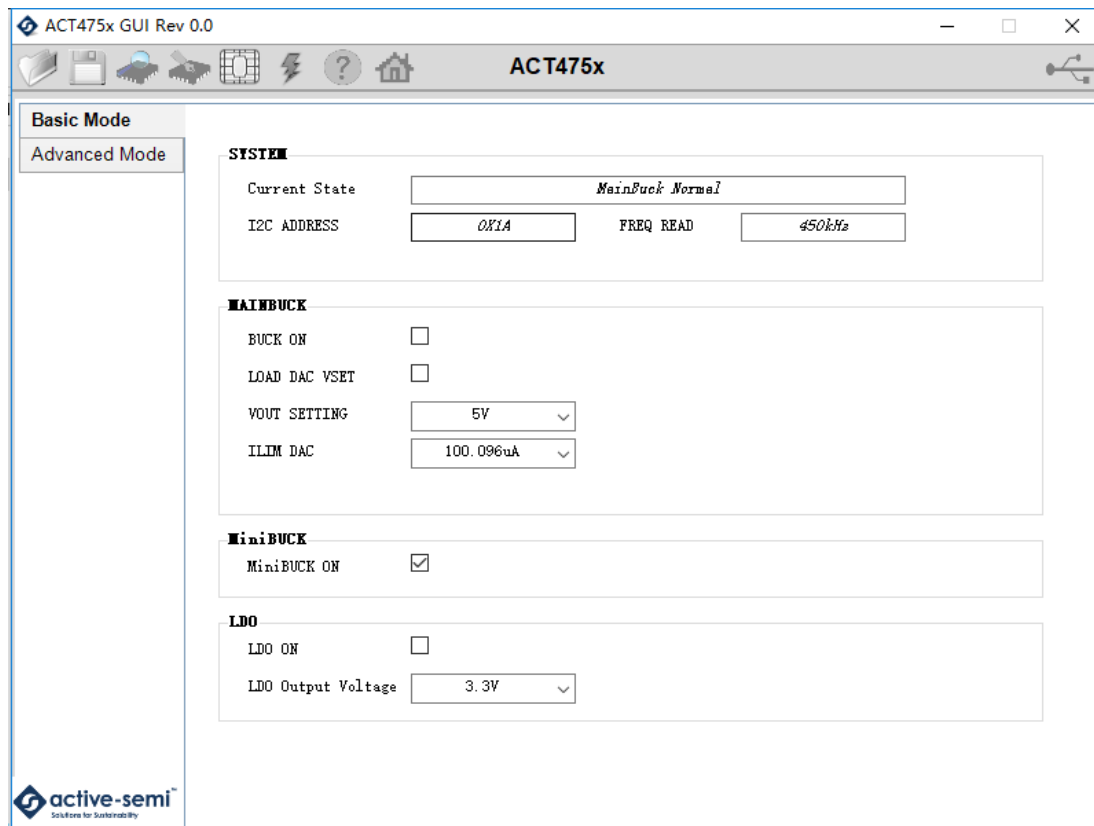

Advanced Mode

Click the “Advanced Mode” button in the left of the GUI screen to see all available user programmable options. With Advanced Mode, additional user programmable features can be selected using the button text. In the left side of the Advanced Mode Screen, click on the Tiles Selector to display the register to view or change. Then change a register one bit at a time by clicking on the desired bit. The value of the bit is display right next to the bit-name button.

Note that the far right side of the screen contains a scroll down button to scroll down to additional registers since the Tile Screen can only display up to 8 bytes at once.

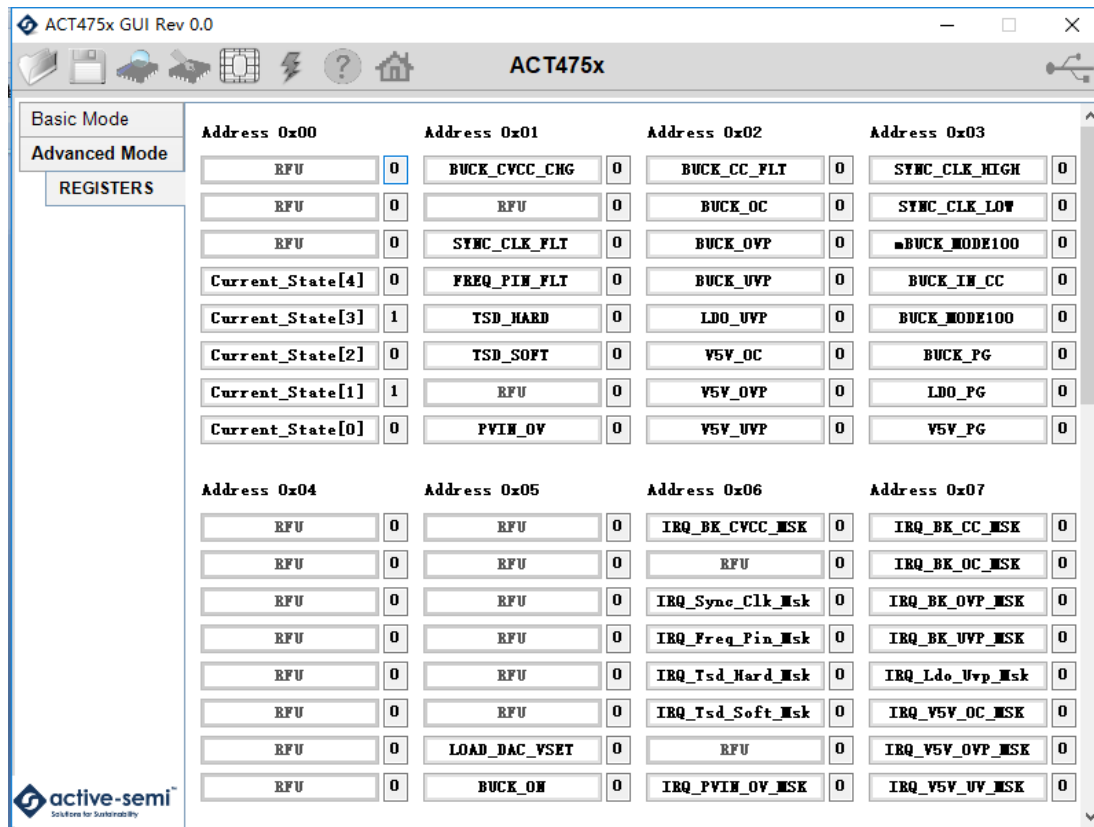

Button Descriptions

Read: Clicking on this button reads the ACT475x registers and displays them in the GUI. Note that this reads all registers. Active-Semi recommends reading registers each time the ACT475x powers-up to acquire the initial register settings. Active-semi also recommends reading registers after making changes to them. Immediately reading the registers after a write confirms the changes were properly stored.

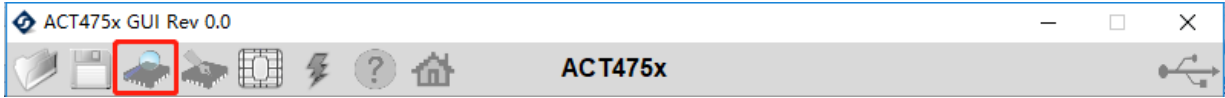

Read Button

Write: Clicking on this button writes the GUI settings to the ACT475x's registers. All registers are written, regardless of whether or not they were changed.

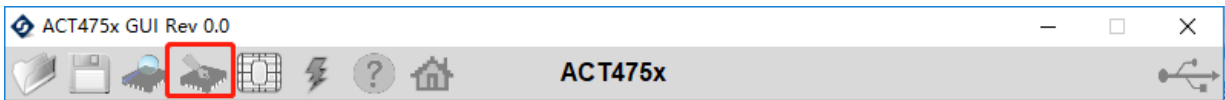

Write Button

Dongle Connection Status: The GUI also contains a dongle connection status that indicates Active-Semi's USB-TO-I2C dongle is connected to the USB port. The figure below shows the two possible indication status graphics.

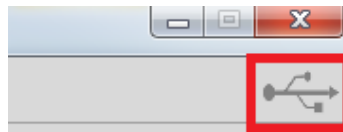

Dongle connected



Dongle Disconnected



Стандарт Электрон Связь

Мы молодая и активно развивающаяся компания в области поставок электронных компонентов. Мы поставляем электронные компоненты отечественного и импортного производства напрямую от производителей и с крупнейших складов мира.

Благодаря сотрудничеству с мировыми поставщиками мы осуществляем комплексные и плановые поставки широчайшего спектра электронных компонентов.

Собственная эффективная логистика и склад в обеспечивает надежную поставку продукции в точно указанные сроки по всей России.

Мы осуществляем техническую поддержку нашим клиентам и предпродажную проверку качества продукции. На все поставляемые продукты мы предоставляем гарантию .

Осуществляем поставки продукции под контролем ВП МО РФ на предприятия военно-промышленного комплекса России , а также работаем в рамках 275 ФЗ с открытием отдельных счетов в уполномоченном банке. Система менеджмента качества компании соответствует требованиям ГОСТ ISO 9001.

Минимальные сроки поставки, гибкие цены, неограниченный ассортимент и индивидуальный подход к клиентам являются основой для выстраивания долгосрочного и эффективного сотрудничества с предприятиями радиоэлектронной промышленности, предприятиями ВПК и научно-исследовательскими институтами России.

С нами вы становитесь еще успешнее!

Наши контакты:

Телефон: +7 812 627 14 35

Электронная почта: sales@st-electron.ru

Адрес: 198099, Санкт-Петербург,
Промышленная ул, дом № 19, литера Н,
помещение 100-Н Офис 331