



TC4421A/TC4422A

9A High-Speed MOSFET Drivers

Features

- High Peak Output Current: 10A (typ.)
- Low Shoot-Through/Cross-Conduction Current in Output Stage
- Wide Input Supply Voltage Operating Range:
 - 4.5V to 18V
- High Continuous Output Current: 2A (max.)
- Matched Fast Rise and Fall Times:
 - 15 ns with 4,700 pF Load
 - 135 ns with 47,000 pF Load
- Matched Short Propagation Delays: 42 ns (typ.)
- Low Supply Current:
 - With Logic '1' Input – 130 μ A (typ.)
 - With Logic '0' Input – 33 μ A (typ.)
- Low Output Impedance: 1.2 Ω (typ.)
- Latch-Up Protected: Will Withstand 1.5A Output Reverse Current
- Input Will Withstand Negative Inputs Up To 5V
- Pin-Compatible with the TC4420/TC4429 and TC4421/TC4422 MOSFET Drivers
- Space-Saving, Thermally-Enhanced, 8-Pin DFN Package

Applications

- Line Drivers for Extra Heavily-Loaded Lines
- Pulse Generators
- Driving the Largest MOSFETs and IGBTs
- Local Power ON/OFF Switch
- Motor and Solenoid Driver
- LF Initiator

General Description

The TC4421A/TC4422A are improved versions of the earlier TC4421/TC4422 family of single-output MOSFET drivers. These devices are high-current buffer/drivers capable of driving large MOSFETs and Insulated Gate Bipolar Transistors (IGBTs). The TC4421A/TC4422A have matched output rise and fall times, as well as matched leading and falling-edge propagation delay times. The TC4421A/TC4422A devices also have very low cross-conduction current, reducing the overall power dissipation of the device.

These devices are essentially immune to any form of upset, except direct overvoltage or over-dissipation. They cannot be latched under any conditions within their power and voltage ratings. These parts are not subject to damage or improper operation when up to 5V of ground bounce is present on their ground terminals. They can accept, without damage or logic upset, more than 1A inductive current of either polarity being forced back into their outputs. In addition, all terminals are fully protected against up to 4 kV of electrostatic discharge.

The TC4421A/TC4422A inputs may be driven directly from either TTL or CMOS (3V to 18V). In addition, 300 mV of hysteresis is built into the input, providing noise immunity and allowing the device to be driven from slowly rising or falling waveforms.

With both surface-mount and pin-through-hole packages, in addition to a wide operating temperature range, the TC4421A/TC4422A family of 9A MOSFET drivers fit into most any application where high gate/line capacitance drive is required.

Package Types⁽¹⁾



TC4421A/TC4422A

Functional Block Diagram



TC4421A/TC4422A

1.0 ELECTRICAL CHARACTERISTICS

Absolute Maximum Ratings †

Supply Voltage	+20V
Input Voltage	($V_{DD} + 0.3V$) to (GND – 5V)
Input Current ($V_{IN} > V_{DD}$)	50 mA

† Stresses above those listed under “Absolute Maximum Ratings” may cause permanent damage to the device. These are stress ratings only and functional operation of the device at these or any other conditions above those indicated in the operation sections of the specifications is not implied. Exposure to Absolute Maximum Rating conditions for extended periods may affect device reliability.

DC CHARACTERISTICS

Electrical Specifications: Unless otherwise noted, $T_A = +25^\circ\text{C}$ with $4.5V \leq V_{DD} \leq 18V$.						
Parameters	Sym	Min	Typ	Max	Units	Conditions
Input						
Logic '1', High Input Voltage	V_{IH}	2.4	1.8	—	V	
Logic '0', Low Input Voltage	V_{IL}	—	1.3	0.8	V	
Input Current	I_{IN}	–10	—	+10	μA	$0V \leq V_{IN} \leq V_{DD}$
Input Voltage	V_{IN}	–5	—	$V_{DD} - 0.3$	V	
Output						
High Output Voltage	V_{OH}	$V_{DD} - 0.025$	—	—	V	DC Test
Low Output Voltage	V_{OL}	—	—	0.025	V	DC Test
Output Resistance, High	R_{OH}	—	1.25	1.5	Ω	$I_{OUT} = 10 \text{ mA}$, $V_{DD} = 18V$
Output Resistance, Low	R_{OL}	—	0.8	1.1	Ω	$I_{OUT} = 10 \text{ mA}$, $V_{DD} = 18V$
Peak Output Current	I_{PK}	—	10.0	—	A	$V_{DD} = 18V$
Continuous Output Current	I_{DC}	2	—	—	A	$10V \leq V_{DD} \leq 18V$, $T_A = +25^\circ\text{C}$ (TC4421A/TC4422A CAT only) (Note 2)
Latch-Up Protection Withstand Reverse Current	I_{REV}	—	>1.5	—	A	Duty cycle $\leq 2\%$, $t \leq 300 \mu\text{sec}$
Switching Time (Note 1)						
Rise Time	t_R	—	28	34	ns	Figure 4-1, $C_L = 10,000 \text{ pF}$
Fall Time	t_F	—	26	32	ns	Figure 4-1, $C_L = 10,000 \text{ pF}$
Propagation Delay Time	t_{D1}	—	38	45	ns	Figure 4-1, $C_L = 10,000 \text{ pF}$
Propagation Delay Time	t_{D2}	—	42	49	ns	Figure 4-1, $C_L = 10,000 \text{ pF}$
Power Supply						
Power Supply Current	I_S	—	130	250	μA	$V_{IN} = 3V$
		—	35	100	μA	$V_{IN} = 0V$
Operating Input Voltage	V_{DD}	4.5	—	18	V	

- Note 1:** Switching times ensured by design.
Note 2: Tested during characterization, not production tested.

TC4421A/TC4422A

DC CHARACTERISTICS (OVER OPERATING TEMPERATURE RANGE)

Electrical Specifications: Unless otherwise noted, over operating temperature range with $4.5V \leq V_{DD} \leq 18V$.						
Parameters	Sym	Min	Typ	Max	Units	Conditions
Input						
Logic '1', High Input Voltage	V_{IH}	2.4	—	—	V	
Logic '0', Low Input Voltage	V_{IL}	—	—	0.8	V	
Input Current	I_{IN}	-10	—	+10	μA	$0V \leq V_{IN} \leq V_{DD}$
Output						
High Output Voltage	V_{OH}	$V_{DD} - 0.025$	—	—	V	DC Test
Low Output Voltage	V_{OL}	—	—	0.025	V	DC Test
Output Resistance, High	R_{OH}	—	—	2.0	Ω	$I_{OUT} = 10 \text{ mA}, V_{DD} = 18V$
Output Resistance, Low	R_{OL}	—	—	1.6	Ω	$I_{OUT} = 10 \text{ mA}, V_{DD} = 18V$
Switching Time (Note 1)						
Rise Time	t_R	—	38	45	ns	Figure 4-1, $C_L = 10,000 \text{ pF}$
Fall Time	t_F	—	33	40	ns	Figure 4-1, $C_L = 10,000 \text{ pF}$
Propagation Delay Time	t_{D1}	—	50.4	60	ns	Figure 4-1, $C_L = 10,000 \text{ pF}$
Propagation Delay Time	t_{D2}	—	53	60	ns	Figure 4-1, $C_L = 10,000 \text{ pF}$
Power Supply						
Power Supply Current	I_S	—	200	500	μA	$V_{IN} = 3V$
		—	50	150	μA	$V_{IN} = 0V$
Operating Input Voltage	V_{DD}	4.5	—	18	V	

Note 1: Switching times ensured by design.

TEMPERATURE CHARACTERISTICS

Electrical Specifications: Unless otherwise noted, all parameters apply with $4.5V \leq V_{DD} \leq 18V$.						
Parameters	Sym	Min	Typ	Max	Units	Conditions
Temperature Ranges						
Specified Temperature Range (V)	T_A	-40	—	+125	$^{\circ}C$	
Maximum Junction Temperature	T_J	—	—	+150	$^{\circ}C$	
Storage Temperature Range	T_A	-65	—	+150	$^{\circ}C$	
Package Thermal Resistances						
Thermal Resistance, 5L-TO-220	θ_{JA}	—	71	—	$^{\circ}C/W$	Without heat sink
Thermal Resistance, 8L-6x5 DFN	θ_{JA}	—	33.2	—	$^{\circ}C/W$	Typical 4-layer board with vias to ground plane
Thermal Resistance, 8L-PDIP	θ_{JA}	—	125	—	$^{\circ}C/W$	
Thermal Resistance, 8L-SOIC	θ_{JA}	—	155	—	$^{\circ}C/W$	

2.0 TYPICAL PERFORMANCE CURVES

Note: The graphs and tables provided following this note are a statistical summary based on a limited number of samples and are provided for informational purposes only. The performance characteristics listed herein are not tested or guaranteed. In some graphs or tables, the data presented may be outside the specified operating range (e.g., outside specified power supply range) and therefore outside the warranted range.

Note: Unless otherwise indicated, $T_A = +25^\circ\text{C}$ with $4.5\text{V} \leq V_{DD} \leq 18\text{V}$.



FIGURE 2-1: Rise Time vs. Supply Voltage.

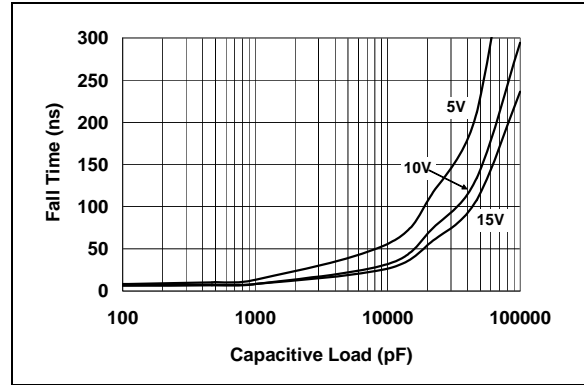

FIGURE 2-4: Fall Time vs. Capacitive Load.



FIGURE 2-2: Rise Time vs. Capacitive Load.

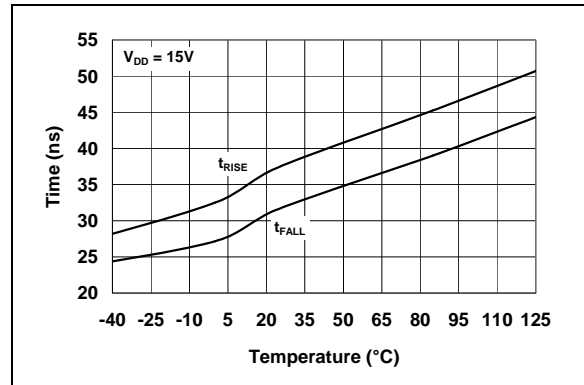

FIGURE 2-5: Rise and Fall Times vs. Temperature.



FIGURE 2-3: Fall Time vs. Supply Voltage.

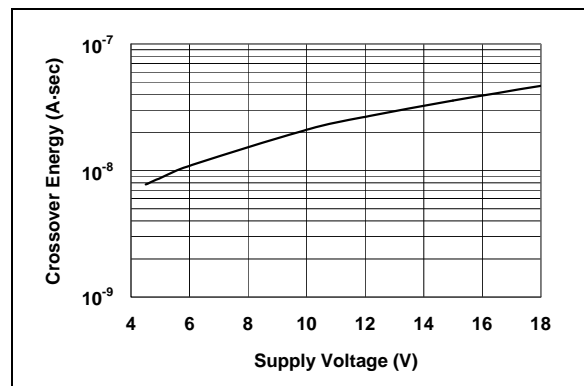

FIGURE 2-6: Crossover Energy vs Supply Voltage.

TC4421A/TC4422A

Note: Unless otherwise indicated, $T_A = +25^\circ\text{C}$ with $4.5\text{V} \leq V_{DD} \leq 18\text{V}$.

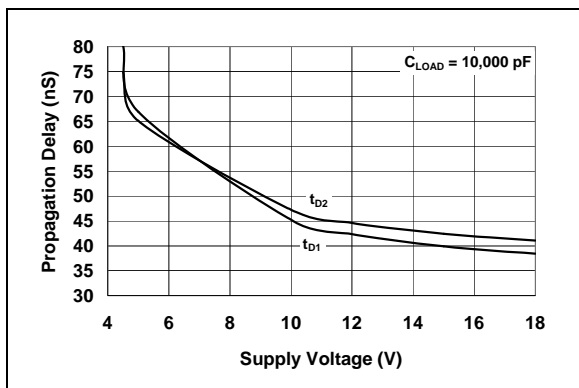

FIGURE 2-7: Propagation Delay vs. Supply Voltage.

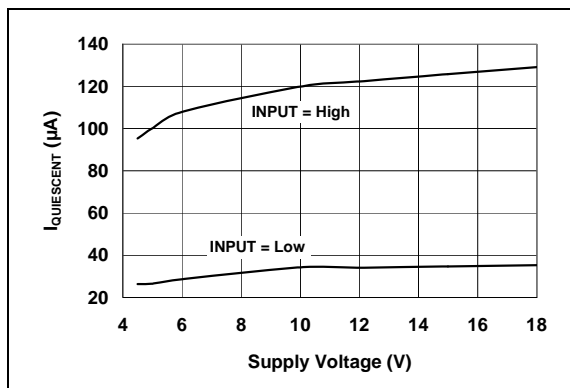

FIGURE 2-10: Quiescent Supply Current vs. Supply Voltage.

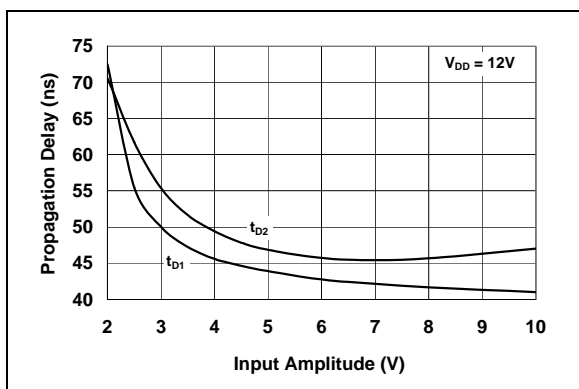

FIGURE 2-8: Propagation Delay vs. Input Amplitude.

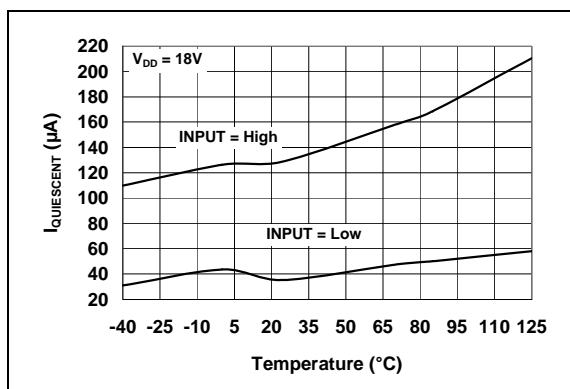

FIGURE 2-11: Quiescent Supply Current vs. Temperature.

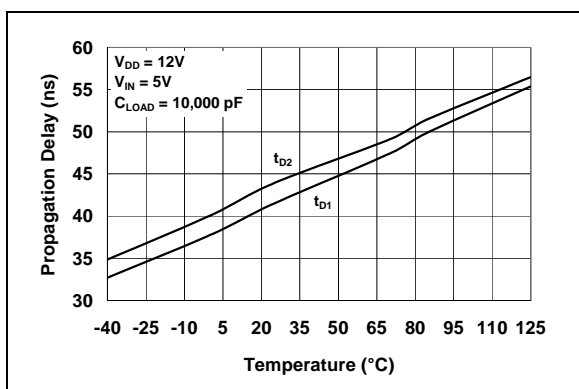

FIGURE 2-9: Propagation Delay vs. Temperature.

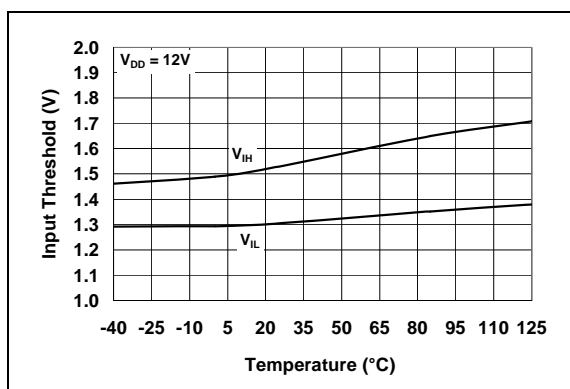

FIGURE 2-12: Input Threshold vs. Temperature.

TC4421A/TC4422A

Note: Unless otherwise indicated, $T_A = +25^\circ\text{C}$ with $4.5\text{V} \leq V_{DD} \leq 18\text{V}$.



FIGURE 2-13: Input Threshold vs. Supply Voltage.

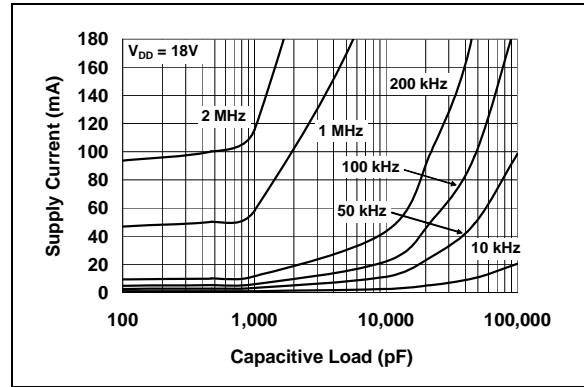

FIGURE 2-16: Supply Current vs. Capacitive Load ($V_{DD} = 18\text{V}$).



FIGURE 2-14: High-State Output Resistance vs. Supply Voltage.

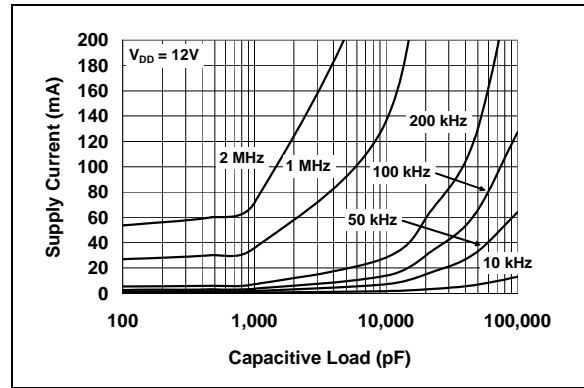

FIGURE 2-17: Supply Current vs. Capacitive Load ($V_{DD} = 12\text{V}$).



FIGURE 2-15: Low-State Output Resistance vs. Supply Voltage.

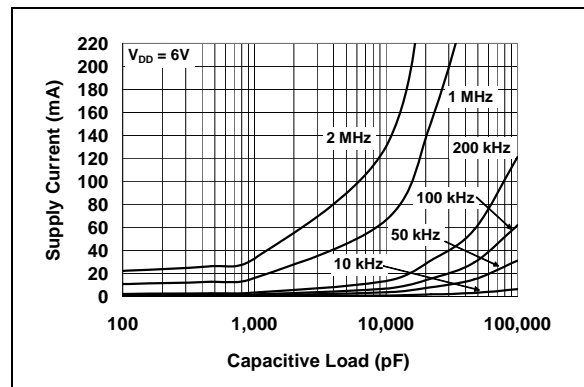

FIGURE 2-18: Supply Current vs. Capacitive Load ($V_{DD} = 6\text{V}$).

TC4421A/TC4422A

Note: Unless otherwise indicated, $T_A = +25^\circ\text{C}$ with $4.5\text{V} \leq V_{DD} \leq 18\text{V}$.



FIGURE 2-19: Supply Current vs. Frequency ($V_{DD} = 18\text{V}$).



FIGURE 2-21: Supply Current vs. Frequency ($V_{DD} = 6\text{V}$).



FIGURE 2-20: Supply Current vs. Frequency ($V_{DD} = 12\text{V}$).

3.0 PIN DESCRIPTIONS

The descriptions of the pins are listed in Table 3-1.

TABLE 3-1: PIN FUNCTION TABLE

Pin No. 8-Pin PDIP, SOIC	Pin No. 8-Pin DFN	Pin No. 5-Pin TO-220	Symbol	Description
1	1	—	V_{DD}	Supply input, 4.5V to 18V
2	2	1	INPUT	Control input, TTL/CMOS-compatible input
3	3	—	NC	No connection
4	4	2	GND	Ground
5	5	4	GND	Ground
6	6	5	OUTPUT	CMOS push-pull output
7	7	—	OUTPUT	CMOS push-pull output
8	8	3	V_{DD}	Supply input, 4.5V to 18V
—	PAD	—	NC	Exposed metal pad
—	—	TAB	V_{DD}	Metal tab is at the V_{DD} potential

3.1 Supply Input (V_{DD})

The V_{DD} input is the bias supply for the MOSFET driver and is rated for 4.5V to 18V with respect to the ground pin. The V_{DD} input should be bypassed to ground with a local ceramic capacitor. The value of the capacitor should be chosen based on the capacitive load that is being driven. A minimum value of 1.0 μ F is suggested.

3.2 Control Input

The MOSFET driver input is a high-impedance, TTL/CMOS-compatible input. The input also has 300 mV of hysteresis between the high and low thresholds that prevents output glitching even when the rise and fall time of the input signal is very slow.

3.3 CMOS Push-Pull Output

The MOSFET driver output is a low-impedance, CMOS, push-pull style output capable of driving a capacitive load with 9.0A peak currents. The MOSFET driver output is capable of withstanding 1.5A peak reverse currents of either polarity.

3.4 Ground

The ground pins are the return path for the bias current and for the high peak currents that discharge the load capacitor. The ground pins should be tied into a ground plane or have very short traces to the bias supply source return.

3.5 Exposed Metal Pad

The exposed metal pad of the 6x5 DFN package is not internally connected to any potential. Therefore, this pad can be connected to a ground plane or other copper plane on a Printed Circuit Board (PCB) to aid in heat removal from the package.

3.6 Metal Tab

The metal tab of the TO-220 package is connected to the V_{DD} potential of the device. This connection to V_{DD} can be used as a current carrying path for the device.

TC4421A/TC4422A

4.0 APPLICATIONS INFORMATION

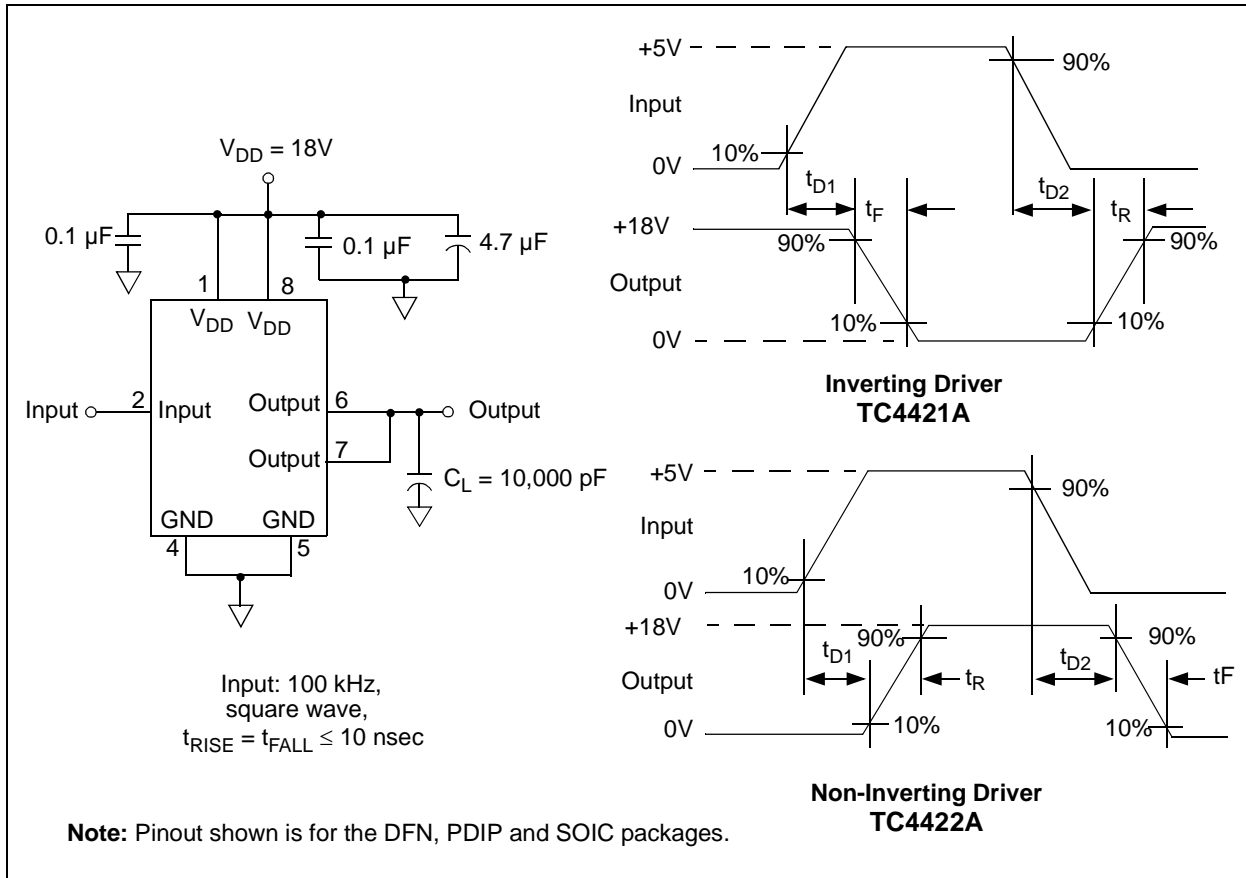

FIGURE 4-1: Switching Time Test Circuits.

5.0 PACKAGING INFORMATION

5.1 Package Marking Information

5-Lead TO-220



Example:



8-Lead DFN



Example:



8-Lead PDIP (300 mil)



Example:

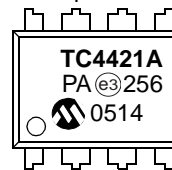

8-Lead SOIC (150 mil)

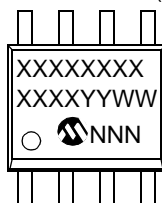

Example:



Legend:	XX...X	Customer-specific information
	Y	Year code (last digit of calendar year)
	YY	Year code (last 2 digits of calendar year)
	WW	Week code (week of January 1 is week '01')
	NNN	Alphanumeric traceability code
	(e3)	Pb-free JEDEC designator for Matte Tin (Sn)
	*	This package is Pb-free. The Pb-free JEDEC designator (e3) can be found on the outer packaging for this package.

Note: In the event the full Microchip part number cannot be marked on one line, it will be carried over to the next line, thus limiting the number of available characters for customer-specific information.

TC4421A/TC4422A

5-Lead Plastic Transistor Outline (AT) (TO-220)

Note: For the most current package drawings, please see the Microchip Packaging Specification located at <http://www.microchip.com/packaging>



Dimension Limits	Units	INCHES*		MILLIMETERS	
		MIN	MAX	MIN	MAX
Lead Pitch	e	.060	.072	1.52	1.83
Overall Lead Centers	e1	.263	.273	6.68	6.93
Space Between Leads	e3	.030	.040	0.76	1.02
Overall Height	A	.160	.190	4.06	4.83
Overall Width	E	.385	.415	9.78	10.54
Overall Length	D	.560	.590	14.22	14.99
Flag Length	H1	.234	.258	5.94	6.55
Flag Thickness	F	.045	.055	1.14	1.40
Through Hole Center	Q	.103	.113	2.62	2.87
Through Hole Diameter	P	.146	.156	3.71	3.96
Lead Length	L	.540	.560	13.72	14.22
Base to Bottom of Lead	J1	.090	.115	2.29	2.92
Lead Thickness	C1	.014	.022	0.36	0.56
Lead Width	b	.025	.040	0.64	1.02
Mold Draft Angle	a	3°	7°	3°	7°

*Controlling Parameter

Notes:

Dimensions D and E1 do not include mold flash or protrusions. Mold flash or protrusions shall not exceed .010" (0.254mm) per side.

JEDEC equivalent: TO-220

Drawing No. C04-036

TC4421A/TC4422A

8-Lead Plastic Dual Flat No Lead Package (MF) 6x5 mm Body (DFN-S) – Saw Singulated

Note: For the most current package drawings, please see the Microchip Packaging Specification located at <http://www.microchip.com/packaging>



Dimension Limits	Units	INCHES			MILLIMETERS*		
		MIN	NOM	MAX	MIN	NOM	MAX
Number of Pins	n	8			8		
Pitch	P	.050 BSC			1.27 BSC		
Overall Height	A	.033	.035	.037	0.85	0.90	0.95
Package Thickness	A2	.031	.035	.037	0.80	0.89	0.95
Standoff	A1	.000	.0004	.002	0.00	0.01	0.05
Base Thickness	A3	.007	.008	.009	0.17	0.20	0.23
Overall Length	E	.195	.197	.199	4.95	5.00	5.05
Exposed Pad Length	E2	.152	.157	.163	3.85	4.00	4.15
Overall Width	D	.234	.236	.238	5.95	6.00	6.05
Exposed Pad Width	D2	.089	.091	.093	2.25	2.30	2.35
Lead Width	B	.014	.016	.019	0.35	0.40	0.47
Lead Length	L	.024		.026	0.60		0.65

Notes:

JEDEC equivalent: MO-220

Drawing No. C04-122

Revised 11/3/03

TC4421A/TC4422A

8-Lead Plastic Dual In-line (PA) – 300 mil (PDIP)

Note: For the most current package drawings, please see the Microchip Packaging Specification located at <http://www.microchip.com/packaging>



Dimension Limits	Units	INCHES*			MILLIMETERS		
		MIN	NOM	MAX	MIN	NOM	MAX
Number of Pins	n		8			8	
Pitch	p		.100			2.54	
Top to Seating Plane	A	.140	.155	.170	3.56	3.94	4.32
Molded Package Thickness	A2	.115	.130	.145	2.92	3.30	3.68
Base to Seating Plane	A1	.015			0.38		
Shoulder to Shoulder Width	E	.300	.313	.325	7.62	7.94	8.26
Molded Package Width	E1	.240	.250	.260	6.10	6.35	6.60
Overall Length	D	.360	.373	.385	9.14	9.46	9.78
Tip to Seating Plane	L	.125	.130	.135	3.18	3.30	3.43
Lead Thickness	c	.008	.012	.015	0.20	0.29	0.38
Upper Lead Width	B1	.045	.058	.070	1.14	1.46	1.78
Lower Lead Width	B	.014	.018	.022	0.36	0.46	0.56
Overall Row Spacing	§ eB	.310	.370	.430	7.87	9.40	10.92
Mold Draft Angle Top	α	5	10	15	5	10	15
Mold Draft Angle Bottom	β	5	10	15	5	10	15

* Controlling Parameter

§ Significant Characteristic

Notes:

Dimensions D and E1 do not include mold flash or protrusions. Mold flash or protrusions shall not exceed .010" (0.254mm) per side.

JEDEC Equivalent: MS-001

Drawing No. C04-018

TC4421A/TC4422A

8-Lead Plastic Small Outline (OA) – Narrow, 150 mil (SOIC)

Note: For the most current package drawings, please see the Microchip Packaging Specification located at <http://www.microchip.com/packaging>



Dimension Limits	Units	INCHES*			MILLIMETERS		
	n	MIN	NOM	MAX	MIN	NOM	MAX
Number of Pins	n	8			8		
Pitch	p		.050			1.27	
Overall Height	A	.053	.061	.069	1.35	1.55	1.75
Molded Package Thickness	A2	.052	.056	.061	1.32	1.42	1.55
Standoff §	A1	.004	.007	.010	0.10	0.18	0.25
Overall Width	E	.228	.237	.244	5.79	6.02	6.20
Molded Package Width	E1	.146	.154	.157	3.71	3.91	3.99
Overall Length	D	.189	.193	.197	4.80	4.90	5.00
Chamfer Distance	h	.010	.015	.020	0.25	0.38	0.51
Foot Length	L	.019	.025	.030	0.48	0.62	0.76
Foot Angle	φ	0	4	8	0	4	8
Lead Thickness	c	.008	.009	.010	0.20	0.23	0.25
Lead Width	B	.013	.017	.020	0.33	0.42	0.51
Mold Draft Angle Top	α	0	12	15	0	12	15
Mold Draft Angle Bottom	β	0	12	15	0	12	15

* Controlling Parameter

§ Significant Characteristic

Notes:

Dimensions D and E1 do not include mold flash or protrusions. Mold flash or protrusions shall not exceed .010" (0.254mm) per side.

JEDEC Equivalent: MS-012

Drawing No. C04-057

TC4421A/TC4422A

NOTES:

APPENDIX A: REVISION HISTORY

Revision A (May 2005)

- Original Release of this Document.

Revision B (January 2013)

Added a note to each package outline drawing.

TC4421A/TC4422A

NOTES:

PRODUCT IDENTIFICATION SYSTEM

To order or obtain information, e.g., on pricing or delivery, refer to the factory or the listed sales office.

<u>PART NO.</u>	<u>X</u>	<u>XX</u>	<u>XXX</u>	
Device	Temperature Range	Package	Tape & Reel	
<p>Device: TC4421A: 9A High-Speed MOSFET Driver, Inverting TC4422A: 9A High-Speed MOSFET Driver, Non-Inverting</p> <p>Temperature Range: V = -40°C to +125°C</p> <p>Package: *</p> <p>AT = TO-220, 5-lead MF = Dual, Flat, No-Lead (6x5 mm Body), 8-lead MF713 = Dual, Flat, No-Lead (6x5 mm Body), 8-lead (Tape and Reel) PA = Plastic DIP (300 mil Body), 8-lead OA = Plastic SOIC (150 mil Body), 8-lead OA713 = Plastic SOIC (150 mil Body), 8-lead (Tape and Reel)</p> <p>*All package offerings are Pb Free (Lead Free).</p>				
				<p>Examples:</p> <p>a) TC4421AVAT: 9A High-Speed Inverting MOSFET Driver, TO-220 package, -40°C to +125°C.</p> <p>b) TC4421AVOA: 9A High-Speed Inverting MOSFET Driver, SOIC package, -40°C to +125°C.</p> <p>c) TC4421AVMF: 9A High-Speed Inverting MOSFET Driver, DFN package, -40°C to +125°C.</p> <p>a) TC4422AVPA: 9A High-Speed Non-Inverting MOSFET Driver, PDIP package, -40°C to +125°C.</p> <p>b) TC4422AVOA: 9A High-Speed Non-Inverting MOSFET Driver, SOIC package, -40°C to +125°C.</p> <p>c) TC4422AVMF: 9A High-Speed Non-Inverting MOSFET Driver, DFN package, -40°C to +125°C.</p>

TC4421A/TC4422A

NOTES:

Note the following details of the code protection feature on Microchip devices:

- Microchip products meet the specification contained in their particular Microchip Data Sheet.
- Microchip believes that its family of products is one of the most secure families of its kind on the market today, when used in the intended manner and under normal conditions.
- There are dishonest and possibly illegal methods used to breach the code protection feature. All of these methods, to our knowledge, require using the Microchip products in a manner outside the operating specifications contained in Microchip's Data Sheets. Most likely, the person doing so is engaged in theft of intellectual property.
- Microchip is willing to work with the customer who is concerned about the integrity of their code.
- Neither Microchip nor any other semiconductor manufacturer can guarantee the security of their code. Code protection does not mean that we are guaranteeing the product as “unbreakable.”

Code protection is constantly evolving. We at Microchip are committed to continuously improving the code protection features of our products. Attempts to break Microchip's code protection feature may be a violation of the Digital Millennium Copyright Act. If such acts allow unauthorized access to your software or other copyrighted work, you may have a right to sue for relief under that Act.

Information contained in this publication regarding device applications and the like is provided only for your convenience and may be superseded by updates. It is your responsibility to ensure that your application meets with your specifications. MICROCHIP MAKES NO REPRESENTATIONS OR WARRANTIES OF ANY KIND WHETHER EXPRESS OR IMPLIED, WRITTEN OR ORAL, STATUTORY OR OTHERWISE, RELATED TO THE INFORMATION, INCLUDING BUT NOT LIMITED TO ITS CONDITION, QUALITY, PERFORMANCE, MERCHANTABILITY OR FITNESS FOR PURPOSE. Microchip disclaims all liability arising from this information and its use. Use of Microchip devices in life support and/or safety applications is entirely at the buyer's risk, and the buyer agrees to defend, indemnify and hold harmless Microchip from any and all damages, claims, suits, or expenses resulting from such use. No licenses are conveyed, implicitly or otherwise, under any Microchip intellectual property rights.

Trademarks

The Microchip name and logo, the Microchip logo, dsPIC, FlashFlex, KEELOQ, KEELOQ logo, MPLAB, PIC, PICmicro, PICSTART, PIC³² logo, rPIC, SST, SST Logo, SuperFlash and UNI/O are registered trademarks of Microchip Technology Incorporated in the U.S.A. and other countries.

FilterLab, Hampshire, HI-TECH C, Linear Active Thermistor, MTP, SEEVAL and The Embedded Control Solutions Company are registered trademarks of Microchip Technology Incorporated in the U.S.A.

Silicon Storage Technology is a registered trademark of Microchip Technology Inc. in other countries.

Analog-for-the-Digital Age, Application Maestro, BodyCom, chipKIT, chipKIT logo, CodeGuard, dsPICDEM, dsPICDEM.net, dsPICworks, dsSPEAK, ECAN, ECONOMONITOR, FanSense, HI-TIDE, In-Circuit Serial Programming, ICSP, Mindi, MiWi, MPASM, MPF, MPLAB Certified logo, MPLIB, MPLINK, mTouch, Omniclient Code Generation, PICC, PICC-18, PICDEM, PICDEM.net, PICkit, PICtail, REAL ICE, rLAB, Select Mode, SQI, Serial Quad I/O, Total Endurance, TSHARC, UniWinDriver, WiperLock, ZENA and Z-Scale are trademarks of Microchip Technology Incorporated in the U.S.A. and other countries.

SQTP is a service mark of Microchip Technology Incorporated in the U.S.A.

GestIC and ULPP are registered trademarks of Microchip Technology Germany II GmbH & Co. & KG, a subsidiary of Microchip Technology Inc., in other countries.

All other trademarks mentioned herein are property of their respective companies.

© 2005-2013, Microchip Technology Incorporated, Printed in the U.S.A., All Rights Reserved.

 Printed on recycled paper.

ISBN: 9781620769218

QUALITY MANAGEMENT SYSTEM
CERTIFIED BY DNV
== ISO/TS 16949 ==

Microchip received ISO/TS-16949:2009 certification for its worldwide headquarters, design and wafer fabrication facilities in Chandler and Tempe, Arizona; Gresham, Oregon and design centers in California and India. The Company's quality system processes and procedures are for its PIC[®] MCUs and dsPIC[®] DSCs, KEELOQ[®] code hopping devices, Serial EEPROMs, microperipherals, nonvolatile memory and analog products. In addition, Microchip's quality system for the design and manufacture of development systems is ISO 9001:2000 certified.



MICROCHIP

Worldwide Sales and Service

AMERICAS

Corporate Office
2355 West Chandler Blvd.
Chandler, AZ 85224-6199
Tel: 480-792-7200
Fax: 480-792-7277
Technical Support:
<http://www.microchip.com/support>
Web Address:
www.microchip.com

Atlanta
Duluth, GA
Tel: 678-957-9614
Fax: 678-957-1455

Boston
Westborough, MA
Tel: 774-760-0087
Fax: 774-760-0088

Chicago
Itasca, IL
Tel: 630-285-0071
Fax: 630-285-0075

Cleveland
Independence, OH
Tel: 216-447-0464
Fax: 216-447-0643

Dallas
Addison, TX
Tel: 972-818-7423
Fax: 972-818-2924

Detroit
Farmington Hills, MI
Tel: 248-538-2250
Fax: 248-538-2260

Indianapolis
Noblesville, IN
Tel: 317-773-8323
Fax: 317-773-5453

Los Angeles
Mission Viejo, CA
Tel: 949-462-9523
Fax: 949-462-9608

Santa Clara
Santa Clara, CA
Tel: 408-961-6444
Fax: 408-961-6445

Toronto
Mississauga, Ontario,
Canada
Tel: 905-673-0699
Fax: 905-673-6509

ASIA/PACIFIC

Asia Pacific Office
Suites 3707-14, 37th Floor
Tower 6, The Gateway
Harbour City, Kowloon
Hong Kong
Tel: 852-2401-1200
Fax: 852-2401-3431

Australia - Sydney
Tel: 61-2-9868-6733
Fax: 61-2-9868-6755

China - Beijing
Tel: 86-10-8569-7000
Fax: 86-10-8528-2104

China - Chengdu
Tel: 86-28-8665-5511
Fax: 86-28-8665-7889

China - Chongqing
Tel: 86-23-8980-9588
Fax: 86-23-8980-9500

China - Hangzhou
Tel: 86-571-2819-3187
Fax: 86-571-2819-3189

China - Hong Kong SAR
Tel: 852-2943-5100
Fax: 852-2401-3431

China - Nanjing
Tel: 86-25-8473-2460
Fax: 86-25-8473-2470

China - Qingdao
Tel: 86-532-8502-7355
Fax: 86-532-8502-7205

China - Shanghai
Tel: 86-21-5407-5533
Fax: 86-21-5407-5066

China - Shenyang
Tel: 86-24-2334-2829
Fax: 86-24-2334-2393

China - Shenzhen
Tel: 86-755-8864-2200
Fax: 86-755-8203-1760

China - Wuhan
Tel: 86-27-5980-5300
Fax: 86-27-5980-5118

China - Xian
Tel: 86-29-8833-7252
Fax: 86-29-8833-7256

China - Xiamen
Tel: 86-592-2388138
Fax: 86-592-2388130

China - Zhuhai
Tel: 86-756-3210040
Fax: 86-756-3210049

ASIA/PACIFIC

India - Bangalore
Tel: 91-80-3090-4444
Fax: 91-80-3090-4123

India - New Delhi
Tel: 91-11-4160-8631
Fax: 91-11-4160-8632

India - Pune
Tel: 91-20-2566-1512
Fax: 91-20-2566-1513

Japan - Osaka
Tel: 81-6-6152-7160
Fax: 81-6-6152-9310

Japan - Tokyo
Tel: 81-3-6880-3770
Fax: 81-3-6880-3771

Korea - Daegu
Tel: 82-53-744-4301
Fax: 82-53-744-4302

Korea - Seoul
Tel: 82-2-554-7200
Fax: 82-2-558-5932 or
82-2-558-5934

Malaysia - Kuala Lumpur
Tel: 60-3-6201-9857
Fax: 60-3-6201-9859

Malaysia - Penang
Tel: 60-4-227-8870
Fax: 60-4-227-4068

Philippines - Manila
Tel: 63-2-634-9065
Fax: 63-2-634-9069

Singapore
Tel: 65-6334-8870
Fax: 65-6334-8850

Taiwan - Hsin Chu
Tel: 886-3-5778-366
Fax: 886-3-5770-955

Taiwan - Kaohsiung
Tel: 886-7-213-7828
Fax: 886-7-330-9305

Taiwan - Taipei
Tel: 886-2-2508-8600
Fax: 886-2-2508-0102

Thailand - Bangkok
Tel: 66-2-694-1351
Fax: 66-2-694-1350

EUROPE

Austria - Wels
Tel: 43-7242-2244-39
Fax: 43-7242-2244-393

Denmark - Copenhagen
Tel: 45-4450-2828
Fax: 45-4485-2829

France - Paris
Tel: 33-1-69-53-63-20
Fax: 33-1-69-30-90-79

Germany - Munich
Tel: 49-89-627-144-0
Fax: 49-89-627-144-44

Italy - Milan
Tel: 39-0331-742611
Fax: 39-0331-466781

Netherlands - Drunen
Tel: 31-416-690399
Fax: 31-416-690340

Spain - Madrid
Tel: 34-91-708-08-90
Fax: 34-91-708-08-91

UK - Wokingham
Tel: 44-118-921-5869
Fax: 44-118-921-5820

11/29/12



Стандарт Электрон Связь

Мы молодая и активно развивающаяся компания в области поставок электронных компонентов. Мы поставляем электронные компоненты отечественного и импортного производства напрямую от производителей и с крупнейших складов мира.

Благодаря сотрудничеству с мировыми поставщиками мы осуществляем комплексные и плановые поставки широчайшего спектра электронных компонентов.

Собственная эффективная логистика и склад в обеспечивает надежную поставку продукции в точно указанные сроки по всей России.

Мы осуществляем техническую поддержку нашим клиентам и предпродажную проверку качества продукции. На все поставляемые продукты мы предоставляем гарантию .

Осуществляем поставки продукции под контролем ВП МО РФ на предприятия военно-промышленного комплекса России , а также работаем в рамках 275 ФЗ с открытием отдельных счетов в уполномоченном банке. Система менеджмента качества компании соответствует требованиям ГОСТ ISO 9001.

Минимальные сроки поставки, гибкие цены, неограниченный ассортимент и индивидуальный подход к клиентам являются основой для выстраивания долгосрочного и эффективного сотрудничества с предприятиями радиоэлектронной промышленности, предприятиями ВПК и научно-исследовательскими институтами России.

С нами вы становитесь еще успешнее!

Наши контакты:

Телефон: +7 812 627 14 35

Электронная почта: sales@st-electron.ru

Адрес: 198099, Санкт-Петербург,
Промышленная ул, дом № 19, литера Н,
помещение 100-Н Офис 331