

## FEATURES

- Comparator with on-chip reference
- Ultralow power consumption with  $I_{CC} = 92 \text{ nA}$  (typical)
- Precision low voltage monitoring down to 0.5 V
- Accurate internal reference level over full temperature range
  - $\pm 1.6\%$  at 1 V
  - $\pm 2.2\%$  at 0.5 V
- Enable input
- 23  $\mu\text{s}$  typical propagation delay
- Open-drain type output
- Input glitch immunity
- Available in a 1.46 mm  $\times$  0.96 mm WLCSP
- Operational temperature range:  $-40^\circ\text{C}$  to  $+85^\circ\text{C}$

## APPLICATIONS

- Portable/battery-operated equipment
- Battery monitors
- Energy harvesting

## GENERAL DESCRIPTION

The **ADCMP380** is an ultralow power voltage comparator with internal reference suitable for use in general-purpose applications. The ultralow power consumption of this device makes it suitable for power efficiency sensitive systems, such as battery-powered portable devices and energy meters.

The **ADCMP380** is available with a 0.5 V and 1 V internal reference with  $\pm 2.2\%$  and  $\pm 1.6\%$  accuracy, respectively, over the full temperature range; this internal reference enables the device to monitor the node of interest accurately to 0.5 V. The enable input allows the user to hold the output low regardless of the state of the input.

## FUNCTIONAL BLOCK DIAGRAM

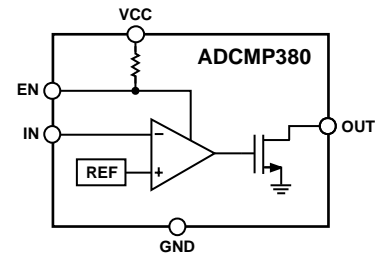

Figure 1.

12783-001

The **ADCMP380** is available in a 6-ball, 1.46 mm  $\times$  0.96 mm WLCSP and is specified over the temperature range of  $-40^\circ\text{C}$  to  $+85^\circ\text{C}$ .

Table 1. Selection Table

Part No.	Reference Voltage (V)	Output
<a href="#">ADCMP380-1</a>	1	Open-drain
<a href="#">ADCMP380-2</a>	0.5	Open-drain

**TABLE OF CONTENTS**

Features .....	1	Typical Performance Characteristics .....	6
Applications.....	1	Theory of Operation .....	8
Functional Block Diagram .....	1	Transient Immunity .....	8
General Description .....	1	Output.....	8
Revision History .....	2	EN Input .....	8
Specifications.....	3	Adding Hysteresis.....	8
Absolute Maximum Ratings.....	4	Device Options .....	9
Thermal Resistance .....	4	Outline Dimensions .....	10
ESD Caution.....	4	Ordering Guide.....	10
Pin Configuration and Function Descriptions.....	5		

**REVISION HISTORY**

<b>2/16—Rev. 0 to Rev. A</b>	
Changes to Ordering Guide .....	10

**3/15—Revision 0: Initial Version**

## SPECIFICATIONS

$V_{CC} = 2\text{ V to } 5.5\text{ V}$ ,  $V_{IN} < V_{CC} + 0.3\text{ V}$ ,  $T_A = -40^\circ\text{C to } +85^\circ\text{C}$ , unless otherwise noted. Typical values are at  $T_A = 25^\circ\text{C}$ .

Table 2.

Parameter	Symbol	Min	Typ	Max	Unit	Test Conditions/Comments
OPERATING VOLTAGE RANGE	$V_{CC}$	2 0.9		5.5	V V	Guarantees valid OUT output Guarantees OUT low
UNDERVOLTAGE LOCKOUT (UVLO)						
Input Voltage Rising	$UVLO_{RISE}$			1.95	V	
Input Voltage Falling	$UVLO_{FALL}$	1.65			V	
Hysteresis	$UVLO_{HYS}$		90		mV	
INPUT CURRENT						
VCC Quiescent Current	$I_{CC}$		92	190	nA	OUT high
				110	nA	OUT high, $T_A = 25^\circ\text{C}$
IN Average Input Current	$I_{VIN}$		4	8.5	nA	$V_{IN} = 2\text{ V}$ , $V_{CC} = 5.5\text{ V}$
			4	32	nA	$V_{IN} = 2\text{ V}$ , $V_{CC} = 2\text{ V}$
REFERENCE VOLTAGE	$V_{REF}$					Input falling
ADCMP380-1		0.984	1	1.016	V	$V_{REF} = 1\text{ V}$
ADCMP380-2		0.489	0.5	0.511	V	$V_{REF} = 0.5\text{ V}$
INPUT HYSTERESIS	$V_{HYST}$		10.3		mV	
PROPAGATION DELAY						
IN to OUT	$t_{PD}$	13.5	23	35	$\mu\text{s}$	IN falling with $V_{REF} \times 10\%$ overdrive
		22	39.5	61	$\mu\text{s}$	IN rising with $V_{REF} \times 10\%$ overdrive
IN GLITCH REJECTION	$t_{GR\_IN}$		21		$\mu\text{s}$	IN falling with $V_{REF} \times 10\%$ overdrive
			38		$\mu\text{s}$	IN rising with $V_{REF} \times 10\%$ overdrive
OUT OUTPUT						
Output Voltage Low	$V_{OUT\_OL}$			0.4	V	$V_{CC} > 4.25\text{ V}$ , $I_{SINK} = 6.5\text{ mA}$
				0.4	V	$V_{CC} > 2.5\text{ V}$ , $I_{SINK} = 6\text{ mA}$
				0.4	V	$V_{CC} > 1.2\text{ V}$ , $I_{SINK} = 4.6\text{ mA}$
				0.4	V	$V_{CC} > 0.9\text{ V}$ , $I_{SINK} = 0.9\text{ mA}$
Leakage Current				5	nA	$V_{OUT} = V_{CC} = 5.5\text{ V}$
EN INPUT						
$V_{IL}$				0.4	V	
$V_{IH}$		0.9			V	
EN Glitch Rejection			0.4		$\mu\text{s}$	
EN to OUT Delay	$t_{D\_EN}$		0.65		$\mu\text{s}$	EN falling
EN Pull-Up Resistance		0.5	0.6	0.82	M $\Omega$	

## ABSOLUTE MAXIMUM RATINGS

Table 3.

Parameter	Rating
VCC	-0.3 V to +6 V
OUT	-0.3 V to +6 V
IN	-0.3 V to +6 V
EN	-0.3 V to V <sub>CC</sub> + 0.3 V
Input/Output Current	10 mA
Storage Temperature Range	-40°C to +150°C
Operating Temperature Range	-40°C to +85°C

Stresses at or above those listed under Absolute Maximum Ratings may cause permanent damage to the product. This is a stress rating only; functional operation of the product at these or any other conditions above those indicated in the operational section of this specification is not implied. Operation beyond the maximum operating conditions for extended periods may affect product reliability.

## THERMAL RESISTANCE

$\theta_{JA}$  is specified for a device soldered on an FR4 board with a minimum footprint.

Table 4.

Package Type	$\theta_{JA}$	Unit
6-Ball WLCSP	105.6	°C/W

## ESD CAUTION



**ESD (electrostatic discharge) sensitive device.** Charged devices and circuit boards can discharge without detection. Although this product features patented or proprietary protection circuitry, damage may occur on devices subjected to high energy ESD. Therefore, proper ESD precautions should be taken to avoid performance degradation or loss of functionality.

## PIN CONFIGURATION AND FUNCTION DESCRIPTIONS

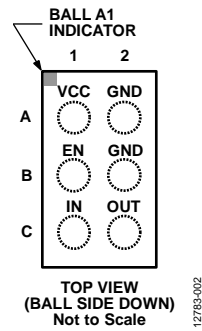

Figure 2. Pin Configuration

Table 5. Pin Function Descriptions

Pin No.	Mnemonic	Description
A1	VCC	Power Supply Input. It is recommended to place a 0.1 $\mu$ F decoupling capacitor between the VCC pin and the GND pin.
A2	GND	Ground. Both GND pins on the <a href="#">ADCMP380</a> must be grounded.
B1	EN	Active High Output Enable Input. If required, a 0.1 $\mu$ F capacitor between the EN pin and ground provides additional noise immunity.
B2	GND	Ground. Both GND pins on the <a href="#">ADCMP380</a> must be grounded.
C1	IN	Comparator Input.
C2	OUT	Open-Drain Comparator Output.

TYPICAL PERFORMANCE CHARACTERISTICS

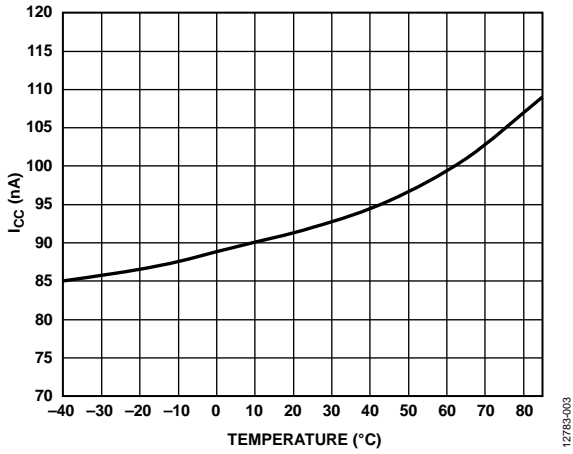

Figure 3. Supply Current ( $I_{CC}$ ) vs. Temperature

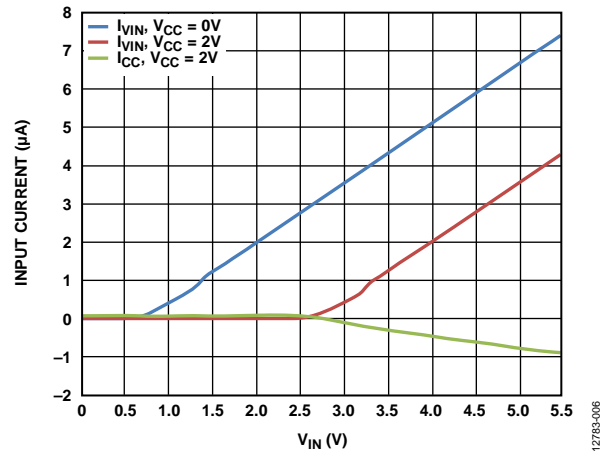

Figure 6. Input Current for IN and VCC vs.  $V_{IN}$

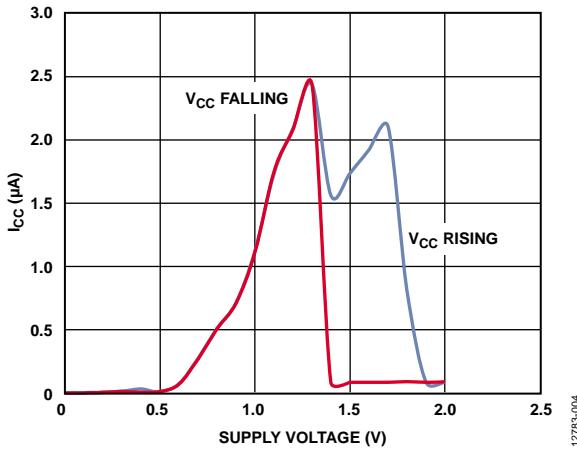

Figure 4. Supply Current ( $I_{CC}$ ) vs. Supply Voltage,  $V_{CC} < 2 V$

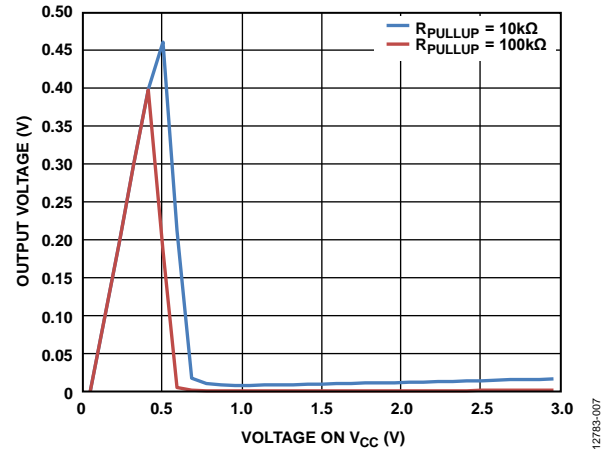

Figure 7. Output Voltage vs. Voltage on VCC (with the OUT Pin Pulled up to the VCC Pin Through  $R_{PULLUP}$ )

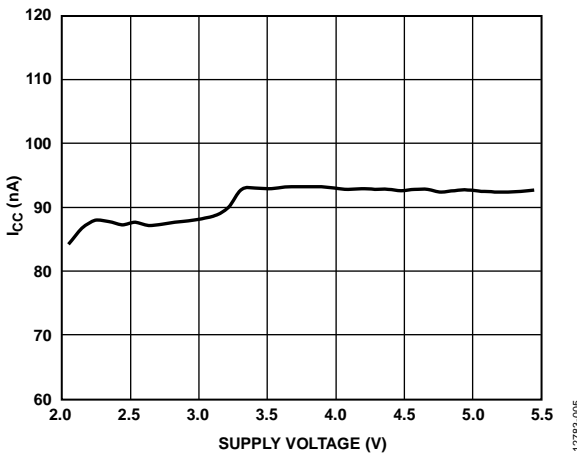

Figure 5. Supply Current ( $I_{CC}$ ) vs. Supply Voltage

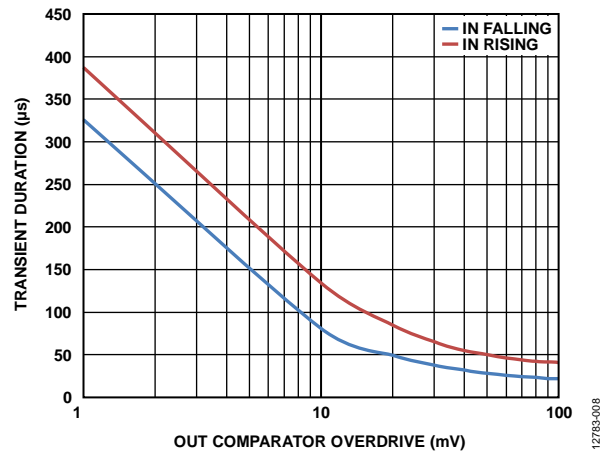

Figure 8. Maximum Transient Duration vs. OUT Comparator Overdrive

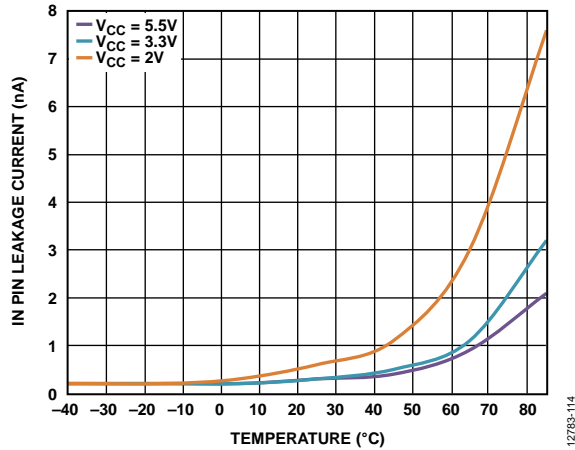

Figure 9. IN Pin Leakage Current vs. Temperature

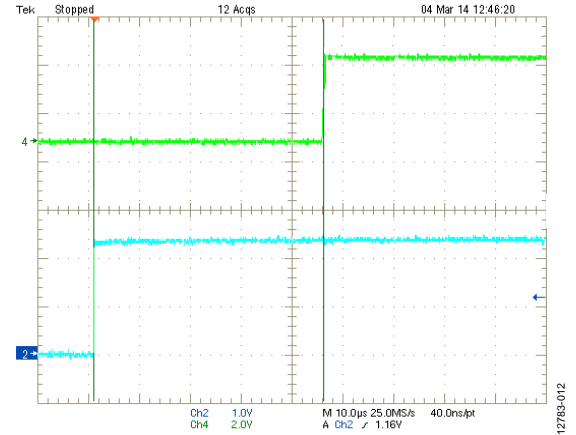

Figure 12. OUT Delay With IN Rising, Channel 2 = IN, Channel 4 = OUT

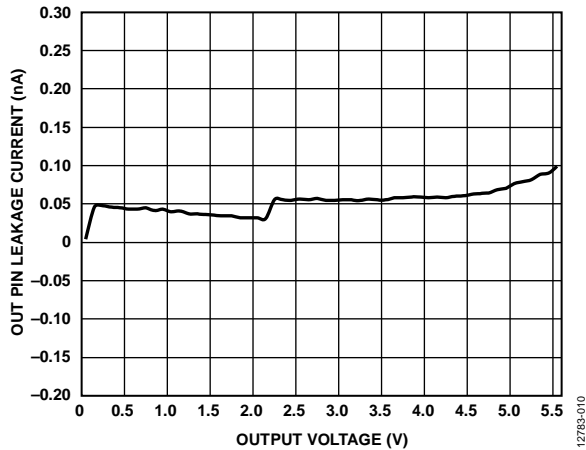

Figure 10. OUT Pin Leakage Current vs. Output Voltage, OUT Logic High

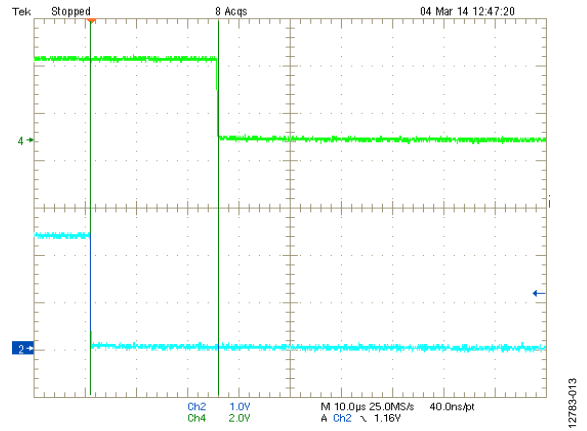

Figure 13. OUT Delay With IN Falling, Channel 2 = IN, Channel 4 = OUT

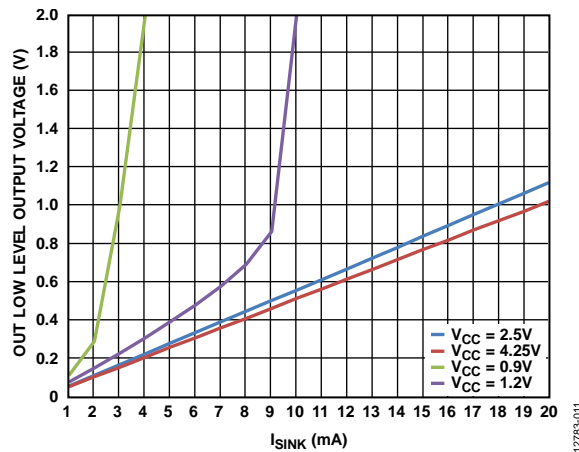

Figure 11. OUT Low Level Output Voltage ( $V_{OUT\_OL}$ ) vs. Sink Current ( $I_{SINK}$ )

## THEORY OF OPERATION

The ADCMP380 ultralow power voltage comparator is especially suited for battery-powered applications due to the maximum 190 nA quiescent current. The internal precision reference and the low input leakage current allow the user to monitor the voltage of interest accurately through external resistor dividers. The device features internal input hysteresis and an open-drain output. The output remains logic high after the voltage on the IN pin is above the internal reference voltage. The device keeps the output in a logic low state whenever the supply voltage on the VCC pin is below the UVLO threshold. The output can be disabled and remains low if the EN pin is pulled low, regardless of the status of the IN pin.

### TRANSIENT IMMUNITY

To avoid unnecessary output state change caused by fast power supply transients, an input glitch filter is added to the IN pin of the ADCMP380 to filter out the transient glitches on the pin.

Figure 8 shows the comparator overdrive (that is, the maximum magnitude of positive and negative going pulses with respect to the reference voltage) vs. the pulse duration without changing the state of the output.

### OUTPUT

The output of ADCMP380 comparator is open-drain. The output is guaranteed to be logic low from when  $V_{CC} = 0.9$  V to when the device exits ULVO.

When the IN voltage falls below the internal reference voltage, the OUT pin asserts low within 23  $\mu$ s (typical). When the monitored voltage rises above the reference voltage plus hysteresis, the OUT pin asserts high within 39.5  $\mu$ s.

### EN INPUT

Driving EN low asserts the output low. The EN input has a 0.6 M $\Omega$  internal pull-up resistor so that the input is always high when unconnected. To drive the EN input, use an external signal or a push-button switch to ground; debounce circuitry is integrated on-chip for this purpose. Noise immunity is provided on the EN input, and fast, negative going transients of up to 0.4  $\mu$ s (typical) are ignored. If required, a 0.1  $\mu$ F capacitor between the EN pin and ground provides additional noise immunity.

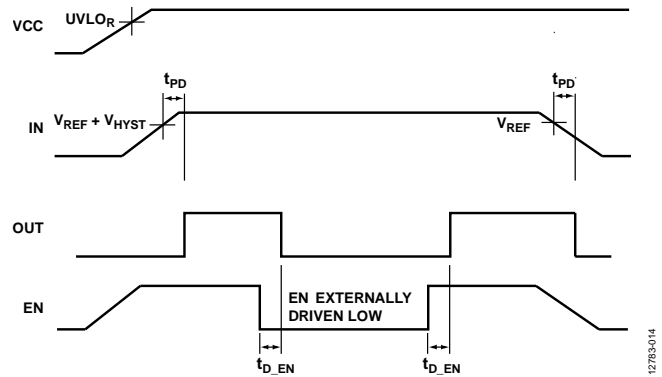

Figure 14. Timing Diagram

### ADDING HYSTERESIS

To prevent oscillations at the output caused by noise or slowly moving signals passing the switching threshold, positive feedback can add hysteresis to the input.

For the configuration shown in Figure 15, connect the bottom end of the input resistor divider to the output; the effective threshold is altered based on the output state.

The input falling threshold level is given by

$$V_{IN\_FALL} = \frac{V_{REF}(R1 + R2 + R_{PULLUP}) - V_{SUPPLY}R1}{R2 + R_{PULLUP}}$$

where  $V_{REF} = 0.6$  V, assuming  $R_{LOAD} \gg R2$  and  $R_{PULLUP}$ , where  $R_{LOAD}$  is the resistance on the load.

The input rising threshold level is given by

$$V_{IN\_RISE} = \frac{V_{REF}(R1 + R2)}{R2}$$

The additional hysteresis is the difference between these voltage levels and is given by

$$\Delta V_{IN} = \frac{V_{REF}R1R_{PULLUP} + V_{SUPPLY}R1R2}{R2 \times R2 + R2 \times R_{PULLUP}}$$

Note that the built in hysteresis of the device is neglected in this calculation.

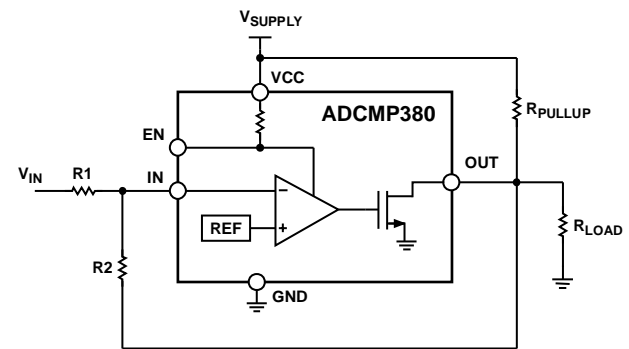

Figure 15. Configuration with Added Hysteresis



## DEVICE OPTIONS

Table 6. Reference Voltage ( $V_{REF}$ ) Options ( $T_A = -40^{\circ}\text{C}$  to  $+85^{\circ}\text{C}$ )

Model Number	Min	Typ	Max	Unit
ADCMP380-1	0.984	1	1.016	V
ADCMP380-2	0.489	0.5	0.511	V

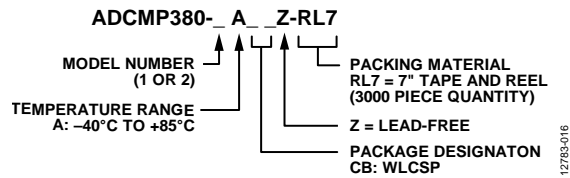

Figure 16. Ordering Code Structure

OUTLINE DIMENSIONS

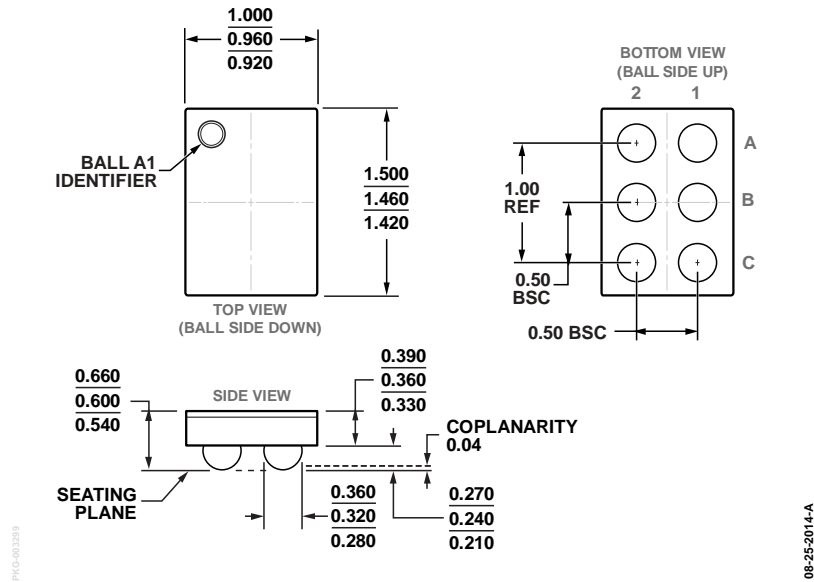

Figure 17. 6-Ball Wafer Level Chip Scale Package [WLCSP] (CB-6-17)  
Dimensions shown in millimeters

ORDERING GUIDE

Model <sup>1</sup>	Temperature Range	Package Description	Package Option	Branding
ADCMP380-1ACBZ-RL7	-40°C to +85°C	6-Ball Wafer Level Chip Scale Package [WLCSP]	CB-6-17	CW
ADCMP380-2ACBZ-RL7	-40°C to +85°C	6-Ball Wafer Level Chip Scale Package [WLCSP]	CB-6-17	LQZ
ADCMP380-EVALZ		Evaluation Board		

<sup>1</sup> Z = RoHS Compliant Part.



## Стандарт Электрон Связь

Мы молодая и активно развивающаяся компания в области поставок электронных компонентов. Мы поставляем электронные компоненты отечественного и импортного производства напрямую от производителей и с крупнейших складов мира.

Благодаря сотрудничеству с мировыми поставщиками мы осуществляем комплексные и плановые поставки широчайшего спектра электронных компонентов.

Собственная эффективная логистика и склад в обеспечивает надежную поставку продукции в точно указанные сроки по всей России.

Мы осуществляем техническую поддержку нашим клиентам и предпродажную проверку качества продукции. На все поставляемые продукты мы предоставляем гарантию .

Осуществляем поставки продукции под контролем ВП МО РФ на предприятия военно-промышленного комплекса России , а также работаем в рамках 275 ФЗ с открытием отдельных счетов в уполномоченном банке. Система менеджмента качества компании соответствует требованиям ГОСТ ISO 9001.

Минимальные сроки поставки, гибкие цены, неограниченный ассортимент и индивидуальный подход к клиентам являются основой для выстраивания долгосрочного и эффективного сотрудничества с предприятиями радиоэлектронной промышленности, предприятиями ВПК и научно-исследовательскими институтами России.

С нами вы становитесь еще успешнее!

### Наши контакты:

**Телефон:** +7 812 627 14 35

**Электронная почта:** [sales@st-electron.ru](mailto:sales@st-electron.ru)

**Адрес:** 198099, Санкт-Петербург,  
Промышленная ул, дом № 19, литера Н,  
помещение 100-Н Офис 331