

EVALUATION KIT  
AVAILABLE**MAXIM****400MHz to 2.5GHz, Low-Noise,  
SiGe Downconverter Mixers****General Description**

The MAX2680/MAX2681/MAX2682 miniature, low-cost, low-noise downconverter mixers are designed for low-voltage operation and are ideal for use in portable communications equipment. Signals at the RF input port are mixed with signals at the local oscillator (LO) port using a double-balanced mixer. These downconverter mixers operate with RF input frequencies between 400MHz and 2500MHz, and downconvert to IF output frequencies between 10MHz and 500MHz.

The MAX2680/MAX2681/MAX2682 operate from a single +2.7V to +5.5V supply, allowing them to be powered directly from a 3-cell NiCd or a 1-cell Lithium battery. These devices offer a wide range of supply currents and input intercept (IIP3) levels to optimize system performance. Additionally, each device features a low-power shutdown mode in which it typically draws less than 0.1µA of supply current. Consult the *Selector Guide* for various combinations of IIP3 and supply current.

The MAX2680/MAX2681/MAX2682 are manufactured on a high-frequency, low-noise, advanced silicon-germanium process and are offered in the space-saving 6-pin SOT23 package.

**Applications**

400MHz/900MHz/2.4GHz ISM-Band Radios  
Personal Communications Systems (PCS)  
Cellular and Cordless Phones  
Wireless Local Loop  
IEEE-802.11 and Wireless Data

*Typical Operating Circuit appears at end of data sheet.*

**Features**

- ◆ 400MHz to 2.5GHz Operation
- ◆ +2.7V to +5.5V Single-Supply Operation
- ◆ Low Noise Figure: 6.3dB at 900MHz (MAX2680)
- ◆ High Input Third-Order Intercept Point (IIP3 at 2450MHz)
  - 6.9dBm at 5.0mA (MAX2680)
  - +1.0dBm at 8.7mA (MAX2681)
  - +3.2dBm at 15.0mA (MAX2682)
- ◆ <0.1µA Low-Power Shutdown Mode
- ◆ Ultra-Small Surface-Mount Packaging

**Ordering Information**

| PART         | TEMP RANGE     | PIN-PACKAGE | SOT TOP MARK |
|--------------|----------------|-------------|--------------|
| MAX2680EUT-T | -40°C to +85°C | 6 SOT23-6   | AAAR         |
| MAX2681EUT-T | -40°C to +85°C | 6 SOT23-6   | AAAS         |
| MAX2682EUT-T | -40°C to +85°C | 6 SOT23-6   | AAAT         |

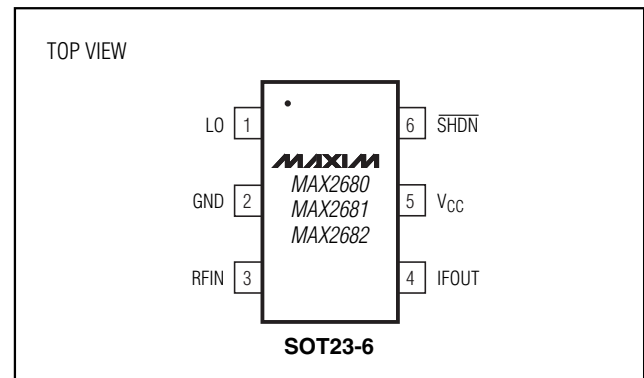
**Pin Configuration****Selector Guide**

| PART    | I <sub>CC</sub> (mA) | FREQUENCY  |         |           |            |         |           |            |         |           |
|---------|----------------------|------------|---------|-----------|------------|---------|-----------|------------|---------|-----------|
|         |                      | 900MHz     |         |           | 1950MHz    |         |           | 2450MHz    |         |           |
|         |                      | IIP3 (dBm) | NF (dB) | GAIN (dB) | IIP3 (dBm) | NF (dB) | GAIN (dB) | IIP3 (dBm) | NF (dB) | GAIN (dB) |
| MAX2680 | 5.0                  | -12.9      | 6.3     | 11.6      | -8.2       | 8.3     | 7.6       | -6.9       | 11.7    | 7.0       |
| MAX2681 | 8.7                  | -6.1       | 7.0     | 14.2      | +0.5       | 11.1    | 8.4       | +1.0       | 12.7    | 7.7       |
| MAX2682 | 15.0                 | -1.8       | 6.5     | 14.7      | +4.4       | 10.2    | 10.4      | +3.2       | 13.4    | 7.9       |

**MAXIM**

Maxim Integrated Products 1

**For free samples & the latest literature: <http://www.maxim-ic.com>, or phone 1-800-998-8800.  
For small orders, phone 1-800-835-8769.**

MAX2680/MAX2681/MAX2682

# 400MHz to 2.5GHz, Low-Noise, SiGe Downconverter Mixers

## ABSOLUTE MAXIMUM RATINGS

|                                    |  |   |                 |
|------------------------------------|--|---|-----------------|
| V <sub>CC</sub> to GND .....       | -0.3V to +6.0V                                     | Continuous Power Dissipation (T <sub>A</sub> = +70°C) |                 |
| RFIN Input Power (50Ω Source)..... | +10dBm   | SOT23-6 (derate 8.7mW/°C above +70°C).....            | 696mW           |
| LO Input Power (50Ω Source).....   | +10dBm   | Operating Temperature Range .....                     | -40°C to +85°C  |
| SHDN, IFOUT, RFIN to GND .....     | -0.3V to (V <sub>CC</sub> + 0.3V)                  | Junction Temperature .....                            | +150°C          |
| LO to GND.....                     | (V <sub>CC</sub> - 1V) to (V <sub>CC</sub> + 0.3V) | Storage Temperature Range .....                       | -65°C to +160°C |
|                                    |  | Lead Temperature (soldering, 10s) .....               | +300°C          |

Stresses beyond those listed under "Absolute Maximum Ratings" may cause permanent damage to the device. These are stress ratings only, and functional operation of the device at these or any other conditions beyond those indicated in the operational sections of the specifications is not implied. Exposure to absolute maximum rating conditions for extended periods may affect device reliability.



**CAUTION!** ESD SENSITIVE DEVICE

## DC ELECTRICAL CHARACTERISTICS

(V<sub>CC</sub> = +2.7V to +5.5V, SHDN = +2V, T<sub>A</sub> = T<sub>MIN</sub> to T<sub>MAX</sub> unless otherwise noted. Typical values are at V<sub>CC</sub> = +3V and T<sub>A</sub> = +25°C. Minimum and maximum values are guaranteed over temperature by design and characterization.)

| PARAMETER                   | SYMBOL            | CONDITIONS                 | MIN | TYP  | MAX  | UNITS |
|-----------------------------|-------------------|----------------------------|-----|------|------|-------|
| Operating Supply Current    | I <sub>CC</sub>   | MAX2680                    |     | 5.0  | 7.7  | mA    |
|                             |                   | MAX2681                    |     | 8.7  | 12.7 |       |
|                             |                   | MAX2682                    |     | 15.0 | 21.8 |       |
| Shutdown Supply Current     | I <sub>CC</sub>   | SHDN = 0.5V                |     | 0.05 | 5    | μA    |
| Shutdown Input Voltage High | V <sub>IH</sub>   |                            | 2.0 |      |      | V     |
| Shutdown Input Voltage Low  | V <sub>IL</sub>   |                            |     |      | 0.5  | V     |
| Shutdown Input Bias Current | I <sub>SHDN</sub> | 0 < SHDN < V <sub>CC</sub> |     | 0.2  |      | μA    |

## AC ELECTRICAL CHARACTERISTICS

(MAX2680/1/2 EV Kit, V<sub>CC</sub> = SHDN = +3.0V, T<sub>A</sub> = +25°C, unless otherwise noted. RFIN and IFOUT matched to 50Ω. P<sub>LO</sub> = -5dBm, P<sub>RFIN</sub> = -25dBm.)

| PARAMETER                                  | CONDITIONS  | MIN | TYP   | MAX  | UNITS |
|--|---|-----|-------|------|-------|
| <b>MAX2680</b>                             |   |     |       |      |       |
| RF Frequency Range                         | (Notes 1, 2)  | 400 |       | 2500 | MHz   |
| LO Frequency Range                         | (Notes 1, 2)  | 400 |       | 2500 | MHz   |
| IF Frequency Range                         | (Notes 1, 2)  | 10  |       | 500  | MHz   |
| Conversion Power Gain                      | f <sub>RF</sub> = 400MHz, f <sub>LO</sub> = 445MHz, f <sub>IF</sub> = 45MHz   |     | 7.3   |      | dB    |
|  | f <sub>RF</sub> = 900MHz, f <sub>LO</sub> = 970MHz, f <sub>IF</sub> = 70MHz   |     | 11.6  |      |       |
|  | f <sub>RF</sub> = 1950MHz, f <sub>LO</sub> = 1880MHz, f <sub>IF</sub> = 70MHz (Note 1)  | 5.7 | 7.6   | 8.6  |       |
|  | f <sub>RF</sub> = 2450MHz, f <sub>LO</sub> = 2210MHz, f <sub>IF</sub> = 240MHz  |     | 7.0   |      |       |
| Gain Variation Over Temperature            | f <sub>RF</sub> = 1950MHz, f <sub>LO</sub> = 1880MHz, f <sub>IF</sub> = 70MHz, T <sub>A</sub> = T <sub>MIN</sub> to T <sub>MAX</sub> (Note 1) |     | 1.9   | 2.4  | dB    |
| Input Third-Order Intercept Point (Note 3) | f <sub>RF</sub> = 900MHz, 901MHz, f <sub>LO</sub> = 970MHz, f <sub>IF</sub> = 70MHz   |     | -12.9 |      | dBm   |
|  | f <sub>RF</sub> = 1950MHz, 1951MHz, f <sub>LO</sub> = 1880MHz, f <sub>IF</sub> = 70MHz  |     | -8.2  |      |       |
|  | f <sub>RF</sub> = 2450MHz, 2451MHz, f <sub>LO</sub> = 2210MHz, f <sub>IF</sub> = 240MHz   |     | -6.9  |      |       |
| Noise Figure (Single Sideband)             | f <sub>RF</sub> = 900MHz, f <sub>LO</sub> = 970MHz, f <sub>IF</sub> = 70MHz   |     | 6.3   |      | dB    |
|  | f <sub>RF</sub> = 1950MHz, f <sub>LO</sub> = 2020MHz, f <sub>IF</sub> = 70MHz   |     | 8.3   |      |       |
|  | f <sub>RF</sub> = 2450MHz, f <sub>LO</sub> = 2210MHz, f <sub>IF</sub> = 240MHz  |     | 11.7  |      |       |
| LO Input VSWR                              | 50Ω source impedance  |     | 1.5:1 |      |       |
| LO Leakage at IFOUT Port                   | f <sub>LO</sub> = 1880MHz   |     | -22   |      | dBm   |

# 400MHz to 2.5GHz, Low-Noise, SiGe Downconverter Mixers

MAX2680/MAX2681/MAX2682

## AC ELECTRICAL CHARACTERISTICS (continued)

(MAX2680/1/2 EV Kit,  $V_{CC} = \overline{\text{SHDN}} = +3.0\text{V}$ ,  $T_A = +25^\circ\text{C}$ , unless otherwise noted. RFIN and IFOUT matched to  $50\Omega$ .  $P_{LO} = -5\text{dBm}$ ,  $P_{RFIN} = -25\text{dBm}$ .)

| PARAMETER                                  | CONDITIONS  | MIN | TYP   | MAX  | UNITS |
|--|---|-----|-------|------|-------|
| LO Leakage at RFIN Port                    | $f_{LO} = 1880\text{MHz}$   |     | -26   |      | dBm   |
| IF/2 Spurious Response                     | $f_{RF} = 1915\text{MHz}$ , $f_{LO} = 1880\text{MHz}$ , $f_{IF} = 70\text{MHz}$ (Note 4)                                |     | -51   |      | dBm   |
| <b>MAX2681</b>                             |   |     |       |      |       |
| RF Frequency Range                         | (Notes 1, 2)  | 400 |       | 2500 | MHz   |
| LO Frequency Range                         | (Notes 1, 2)  | 400 |       | 2500 | MHz   |
| IF Frequency Range                         | (Notes 1, 2)  | 10  |       | 500  | MHz   |
| Conversion Power Gain                      | $f_{RF} = 400\text{MHz}$ , $f_{LO} = 445\text{MHz}$ , $f_{IF} = 45\text{MHz}$   |     | 11.0  |      | dB    |
|  | $f_{RF} = 900\text{MHz}$ , $f_{LO} = 970\text{MHz}$ , $f_{IF} = 70\text{MHz}$   |     | 14.2  |      |       |
|  | $f_{RF} = 1950\text{MHz}$ , $f_{LO} = 1880\text{MHz}$ , $f_{IF} = 70\text{MHz}$ (Note 1)                                | 6.7 | 8.4   | 9.4  |       |
|  | $f_{RF} = 2450\text{MHz}$ , $f_{LO} = 2210\text{MHz}$ , $f_{IF} = 240\text{MHz}$  |     | 7.7   |      |       |
| Gain Variation Over Temperature            | $f_{RF} = 1950\text{MHz}$ , $f_{LO} = 1880\text{MHz}$ , $f_{IF} = 70\text{MHz}$ , $T_A = T_{MIN}$ to $T_{MAX}$ (Note 1) |     | 1.7   | 2.3  | dB    |
| Input Third-Order Intercept Point (Note 3) | $f_{RF} = 900\text{MHz}$ , $901\text{MHz}$ , $f_{LO} = 970\text{MHz}$ , $f_{IF} = 70\text{MHz}$                         |     | -6.1  |      | dBm   |
|  | $f_{RF} = 1950\text{MHz}$ , $1951\text{MHz}$ , $f_{LO} = 1880\text{MHz}$ , $f_{IF} = 70\text{MHz}$                      |     | +0.5  |      |       |
|  | $f_{RF} = 2450\text{MHz}$ , $2451\text{MHz}$ , $f_{LO} = 2210\text{MHz}$ , $f_{IF} = 240\text{MHz}$                     |     | +1.0  |      |       |
| Noise Figure (Single Sideband)             | $f_{RF} = 900\text{MHz}$ , $f_{LO} = 970\text{MHz}$ , $f_{IF} = 70\text{MHz}$   |     | 7.0   |      | dB    |
|  | $f_{RF} = 1950\text{MHz}$ , $f_{LO} = 2020\text{MHz}$ , $f_{IF} = 70\text{MHz}$   |     | 11.1  |      |       |
|  | $f_{RF} = 2450\text{MHz}$ , $f_{LO} = 2210\text{MHz}$ , $f_{IF} = 240\text{MHz}$  |     | 12.7  |      |       |
| LO Input VSWR                              | $50\Omega$ source impedance   |     | 1.5:1 |      |       |
| LO Leakage at IFOUT Port                   | $f_{LO} = 1880\text{MHz}$   |     | -23   |      | dBm   |
| LO Leakage at RFIN Port                    | $f_{LO} = 1880\text{MHz}$   |     | -27   |      | dBm   |
| IF/2 Spurious Response                     | $f_{RF} = 1915\text{MHz}$ , $f_{LO} = 1880\text{MHz}$ , $f_{IF} = 70\text{MHz}$ (Note 4)                                |     | -65   |      | dBm   |
| <b>MAX2682</b>                             |   |     |       |      |       |
| RF Frequency Range                         | (Notes 1, 2)  | 400 |       | 2500 | MHz   |
| LO Frequency Range                         | (Notes 1, 2)  | 400 |       | 2500 | MHz   |
| IF Frequency Range                         | (Notes 1, 2)  | 10  |       | 500  | MHz   |
| Conversion Power Gain                      | $f_{RF} = 400\text{MHz}$ , $f_{LO} = 445\text{MHz}$ , $f_{IF} = 45\text{MHz}$   |     | 13.4  |      | dB    |
|  | $f_{RF} = 900\text{MHz}$ , $f_{LO} = 970\text{MHz}$ , $f_{IF} = 70\text{MHz}$   |     | 14.7  |      |       |
|  | $f_{RF} = 1950\text{MHz}$ , $f_{LO} = 1880\text{MHz}$ , $f_{IF} = 70\text{MHz}$ (Note 1)                                | 8.7 | 10.4  | 11.7 |       |
|  | $f_{RF} = 2450\text{MHz}$ , $f_{LO} = 2210\text{MHz}$ , $f_{IF} = 240\text{MHz}$  |     | 7.9   |      |       |
| Gain Variation Over Temperature            | $f_{RF} = 1950\text{MHz}$ , $f_{LO} = 1880\text{MHz}$ , $f_{IF} = 70\text{MHz}$ , $T_A = T_{MIN}$ to $T_{MAX}$ (Note 1) |     | 2.1   | 3.2  | dB    |
| Input Third-Order Intercept Point (Note 3) | $f_{RF} = 900\text{MHz}$ , $901\text{MHz}$ , $f_{LO} = 970\text{MHz}$ , $f_{IF} = 70\text{MHz}$                         |     | -1.8  |      | dBm   |
|  | $f_{RF} = 1950\text{MHz}$ , $1951\text{MHz}$ , $f_{LO} = 1880\text{MHz}$ , $f_{IF} = 70\text{MHz}$                      |     | +4.4  |      |       |
|  | $f_{RF} = 2450\text{MHz}$ , $2451\text{MHz}$ , $f_{LO} = 2210\text{MHz}$ , $f_{IF} = 240\text{MHz}$                     |     | +3.2  |      |       |
| Noise Figure (Single Sideband)             | $f_{RF} = 900\text{MHz}$ , $f_{LO} = 970\text{MHz}$ , $f_{IF} = 70\text{MHz}$   |     | 6.5   |      | dB    |
|  | $f_{RF} = 1950\text{MHz}$ , $f_{LO} = 2020\text{MHz}$ , $f_{IF} = 70\text{MHz}$   |     | 10.2  |      |       |
|  | $f_{RF} = 2450\text{MHz}$ , $f_{LO} = 2210\text{MHz}$ , $f_{IF} = 240\text{MHz}$  |     | 13.4  |      |       |

# 400MHz to 2.5GHz, Low-Noise, SiGe Downconverter Mixers

## AC ELECTRICAL CHARACTERISTICS (continued)

(MAX2680/1/2 EV Kit,  $V_{CC} = \overline{\text{SHDN}} = +3.0\text{V}$ ,  $T_A = +25^\circ\text{C}$ , unless otherwise noted.  $R_{FIN}$  and  $I_{FOUT}$  matched to  $50\Omega$ .  $P_{LO} = -5\text{dBm}$ ,  $P_{RFIN} = -25\text{dBm}$ .)

| PARAMETER                | CONDITIONS   | MIN | TYP   | MAX | UNITS |
|--------------------------|--|-----|-------|-----|-------|
| LO Input VSWR            | $50\Omega$ source impedance  |     | 1.5:1 |     |       |
| LO Leakage at IFOUT Port | $f_{LO} = 1880\text{MHz}$  |     | -23   |     | dBm   |
| LO Leakage at RFIN Port  | $f_{LO} = 1880\text{MHz}$  |     | -27   |     | dBm   |
| IF/2 Spurious Response   | $f_{RF} = 1915\text{MHz}$ , $f_{LO} = 1880\text{MHz}$ , $f_{IF} = 70\text{MHz}$ (Note 4) |     | -61   |     | dBm   |

**Note 1:** Guaranteed by design and characterization.

**Note 2:** Operation outside of this specification is possible, but performance is not characterized and is not guaranteed.

**Note 3:** Two input tones at  $-25\text{dBm}$  per tone.

**Note 4:** This spurious response is caused by a higher-order mixing product ( $2 \times 2$ ). Specified RF frequency is applied and IF output power is observed at the desired IF frequency ( $70\text{MHz}$ ).

## Typical Operating Characteristics

(Typical Operating Circuit,  $V_{CC} = \overline{\text{SHDN}} = +3.0\text{V}$ ,  $P_{RFIN} = -25\text{dBm}$ ,  $P_{LO} = -5\text{dBm}$ ,  $T_A = +25^\circ\text{C}$ , unless otherwise noted.)

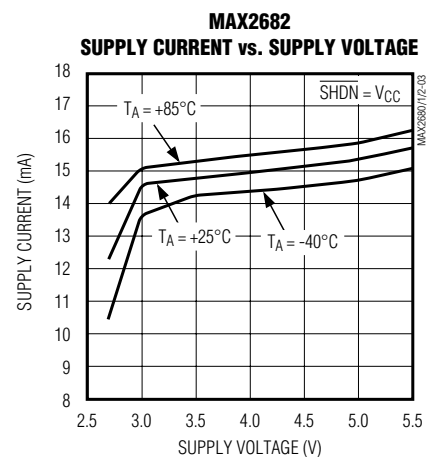
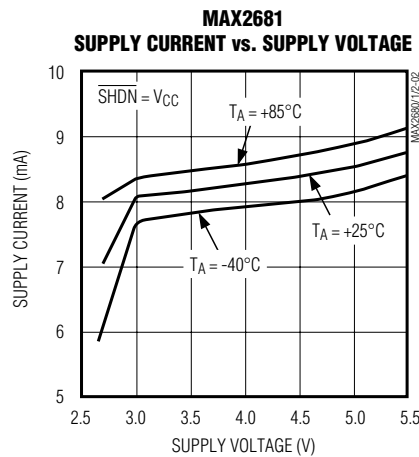
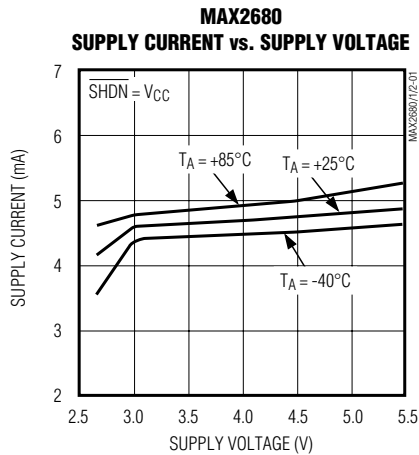

# 400MHz to 2.5GHz, Low-Noise, SiGe Downconverter Mixers

## Typical Operating Characteristics (continued)

(Typical Operating Circuit,  $V_{CC} = \overline{\text{SHDN}} = +3.0\text{V}$ ,  $P_{\text{RFIN}} = -25\text{dBm}$ ,  $P_{\text{LO}} = -5\text{dBm}$ ,  $T_A = +25^\circ\text{C}$ , unless otherwise noted.)

MAX2680/MAX2681/MAX2682

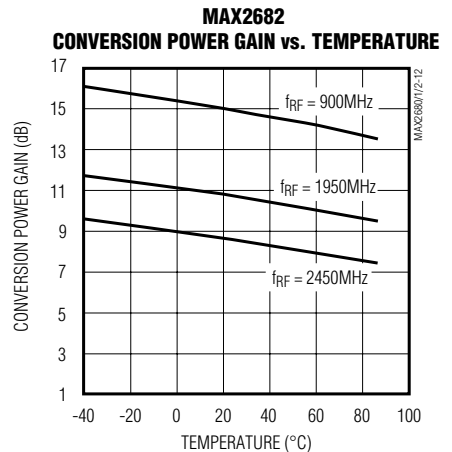
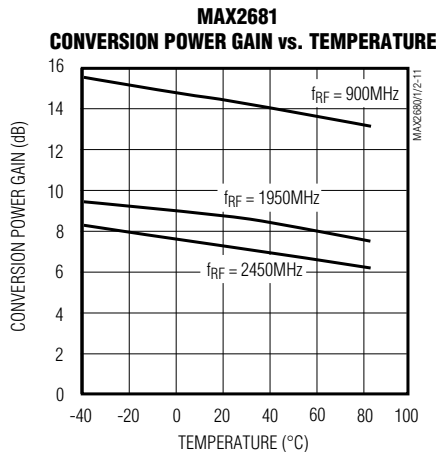
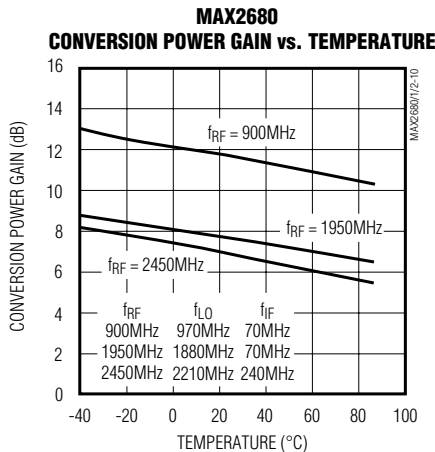
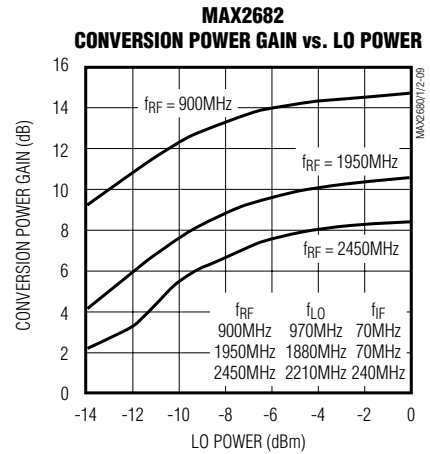
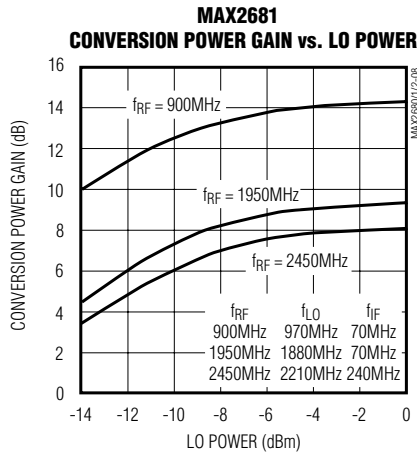
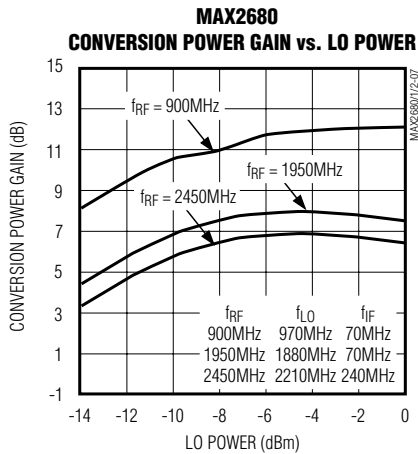
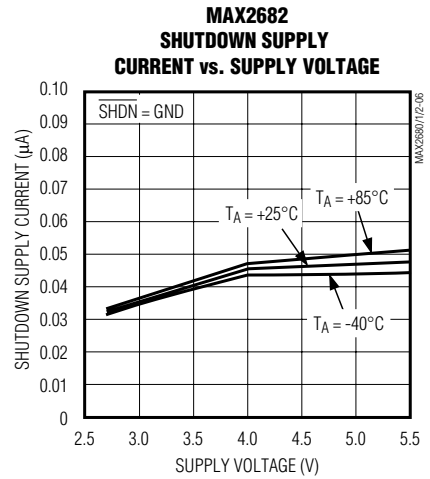
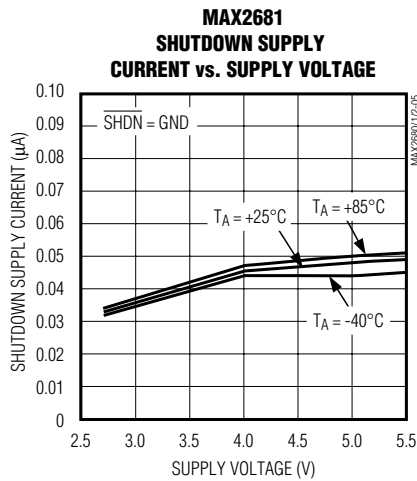
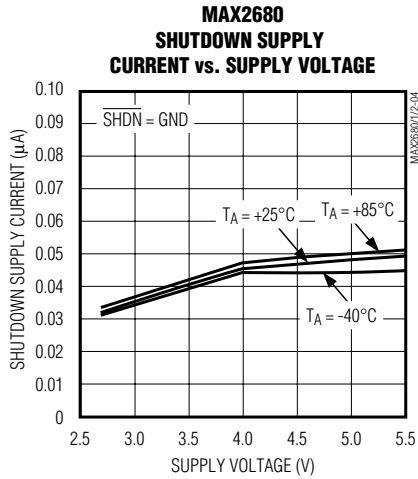

# 400MHz to 2.5GHz, Low-Noise, SiGe Downconverter Mixers

## Typical Operating Characteristics (continued)

(Typical Operating Circuit,  $V_{CC} = \overline{\text{SHDN}} = +3.0\text{V}$ ,  $P_{\text{RFIN}} = -25\text{dBm}$ ,  $P_{\text{LO}} = -5\text{dBm}$ ,  $T_A = +25^\circ\text{C}$ , unless otherwise noted.)

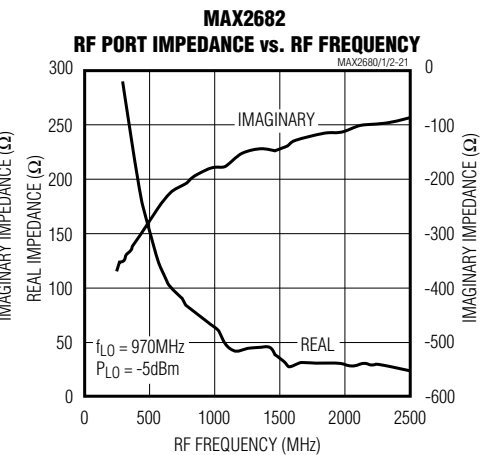
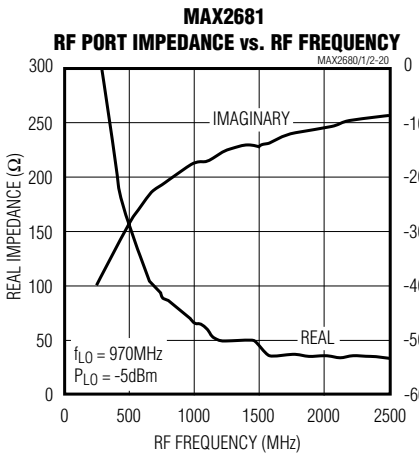
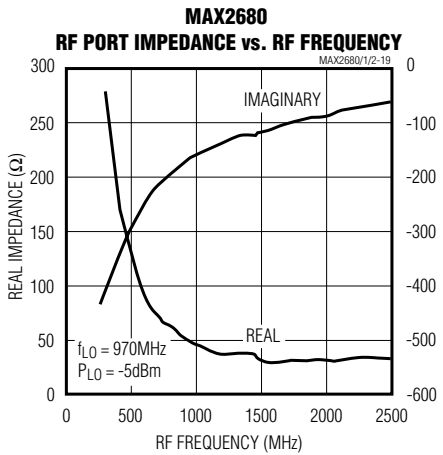
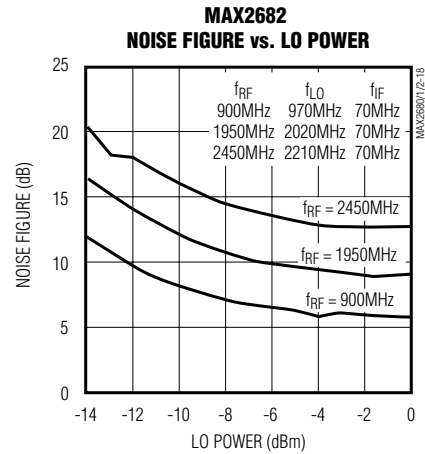
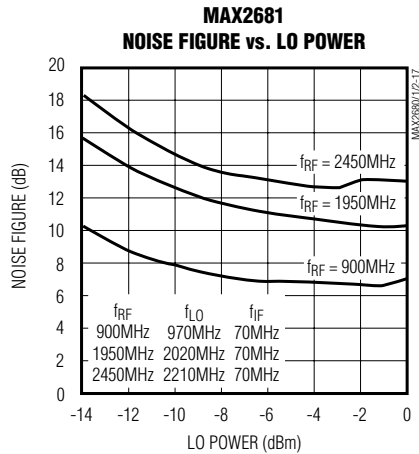
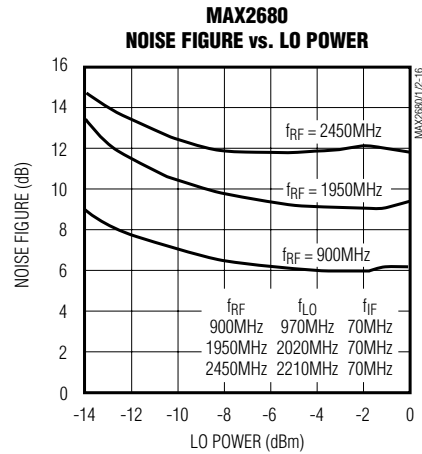
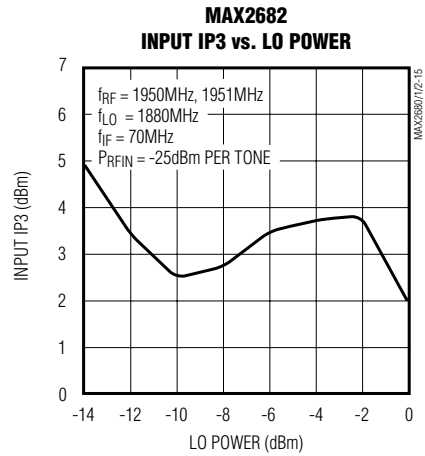
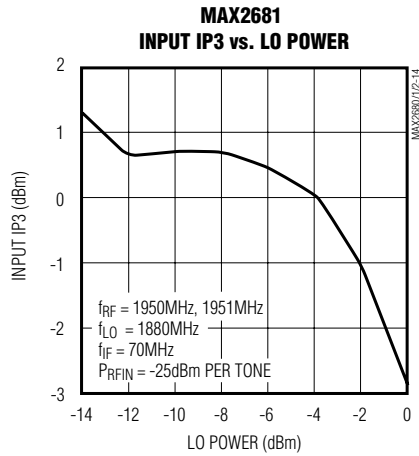
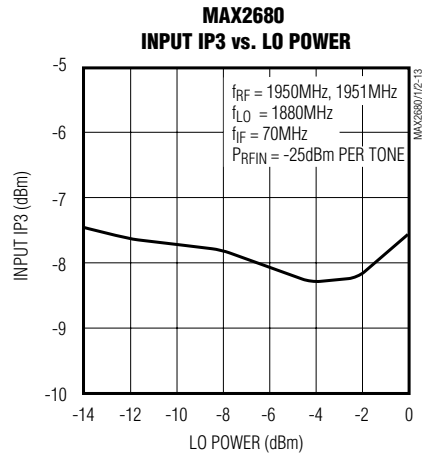

# 400MHz to 2.5GHz, Low-Noise, SiGe Downconverter Mixers

## Typical Operating Characteristics (continued)

(Typical Operating Circuit,  $V_{CC} = \overline{\text{SHDN}} = +3.0\text{V}$ ,  $P_{\text{RFIN}} = -25\text{dBm}$ ,  $P_{\text{LO}} = -5\text{dBm}$ ,  $T_A = +25^\circ\text{C}$ , unless otherwise noted.)

**MAX2680/MAX2681/MAX2682**

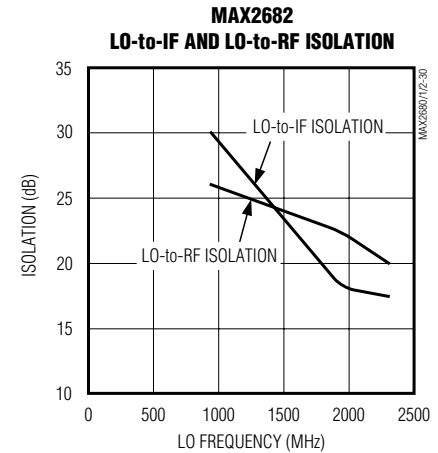
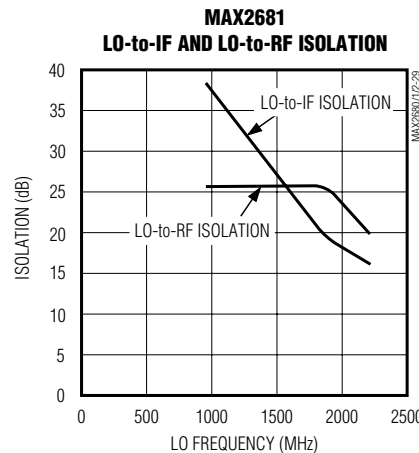
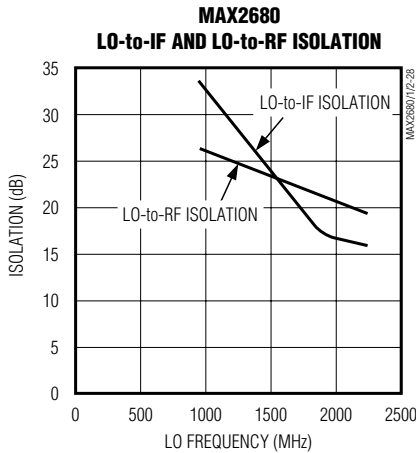
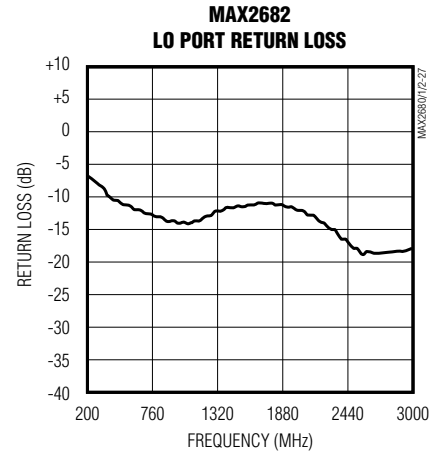
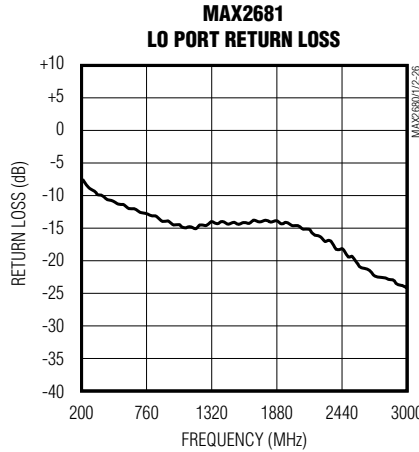
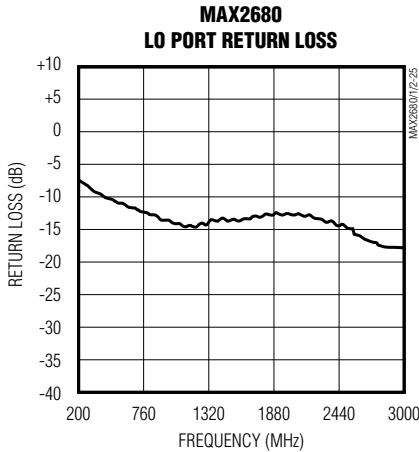
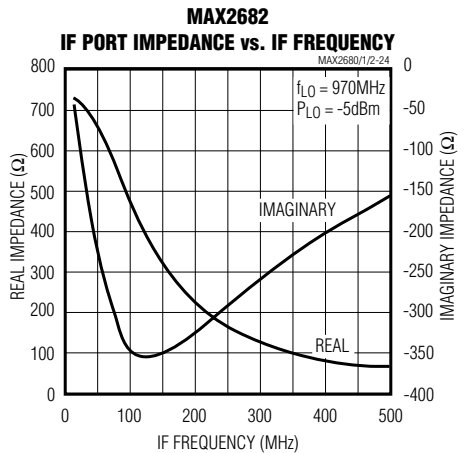
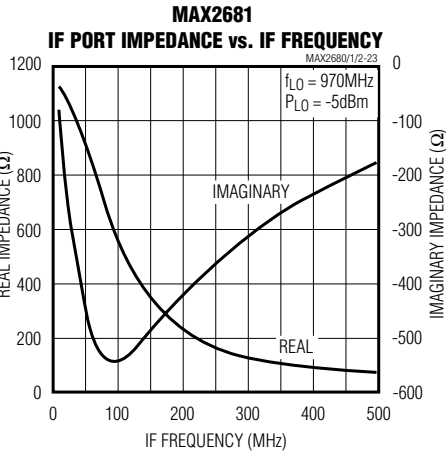
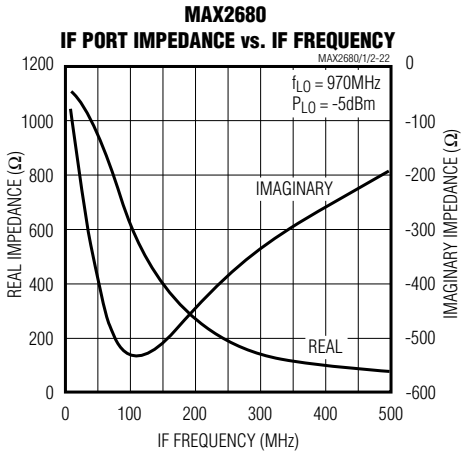

# 400MHz to 2.5GHz, Low-Noise, SiGe Downconverter Mixers

## Typical Operating Characteristics (continued)

(Typical Operating Circuit,  $V_{CC} = \overline{\text{SHDN}} = +3.0\text{V}$ ,  $P_{\text{RFIN}} = -25\text{dBm}$ ,  $P_{\text{LO}} = -5\text{dBm}$ ,  $T_A = +25^\circ\text{C}$ , unless otherwise noted.)

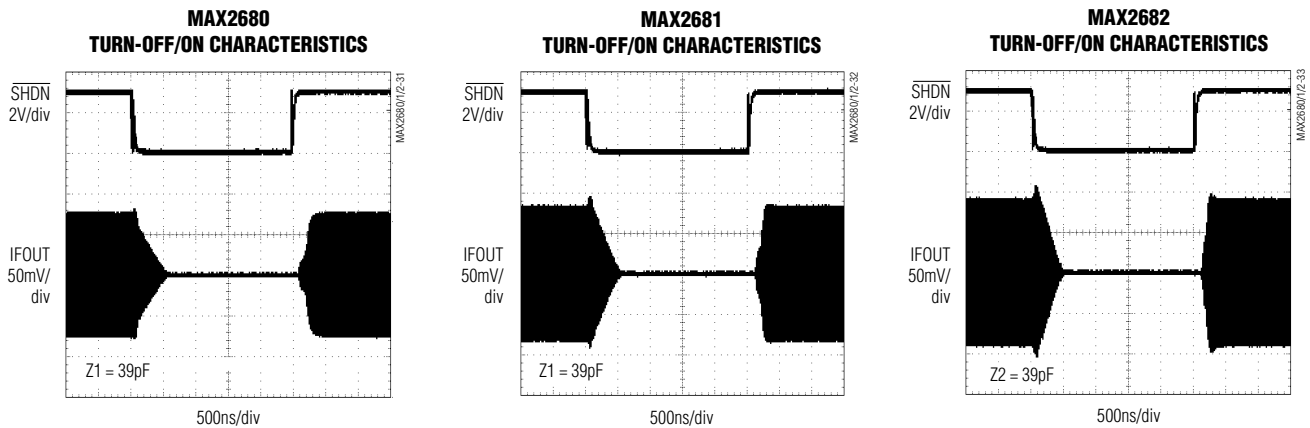

## Pin Description

| PIN | NAME                     | FUNCTION  |
|-----|--------------------------|---|
| 1   | LO                       | Local-Oscillator Input. Apply a local-oscillator signal with an amplitude of $-10\text{dBm}$ to $0$ ( $50\Omega$ source). AC-couple this pin to the oscillator with a DC-blocking capacitor. Nominal DC voltage is $V_{CC} - 0.4\text{V}$ . |
| 2   | GND                      | Mixer Ground. Connect to the ground plane with a low-inductance connection.   |
| 3   | RFIN                     | Radio Frequency Input. AC-couple to this pin with a DC-blocking capacitor. Nominal DC voltage is $1.5\text{V}$ . See <i>Applications Information</i> section for details on impedance matching.   |
| 4   | IFOUT                    | Intermediate Frequency Output. Open-collector output requires an inductor to $V_{CC}$ . AC-couple to this pin with a DC-blocking capacitor. See <i>Applications Information</i> section for details on impedance matching.                  |
| 5   | $V_{CC}$                 | Supply Voltage Input, $+2.7\text{V}$ to $+5.5\text{V}$ . Bypass with a capacitor to the ground plane. Capacitor value depends upon desired operating frequency.   |
| 6   | $\overline{\text{SHDN}}$ | Active-Low Shutdown. Drive low to disable all device functions and reduce the supply current to less than $5\mu\text{A}$ . For normal operation, drive high or connect to $V_{CC}$ .  |



# 400MHz to 2.5GHz, Low-Noise, SiGe Downconverter Mixers

MAX2680/MAX2681/MAX2682

## Detailed Description

The MAX2680/MAX2681/MAX2682 are 400MHz to 2.5GHz, silicon-germanium, double-balanced down-converter mixers. They are designed to provide optimum linearity performance for a specified supply current. They consist of a double-balanced Gilbert-cell mixer with single-ended RF, LO, and IF port connections. An on-chip bias cell provides a low-power shut-down feature. Consult the *Selector Guide* for device features and comparison.

## Applications Information

### Local-Oscillator (LO) Input

The LO input is a single-ended broadband port with a typical input VSWR of better than 2.0:1 from 400MHz to 2.5GHz. The LO signal is mixed with the RF input signal, and the resulting downconverted output appears at IFOUT. AC-couple LO with a capacitor. Drive the LO port with a signal ranging from -10dBm to 0 (50Ω source).

### RF Input

The RF input frequency range is 400MHz to 2.5GHz. The RF input requires an impedance-matching network as well as a DC-blocking capacitor that can be part of the matching network. Consult Tables 1 and 2, as well as the RF Port Impedance vs. RF Frequency graph in the *Typical Operating Characteristics* for information on matching.

**Table 1. RFIN Port Impedance**

| PART    | FREQUENCY |         |         |         |
|---------|-----------|---------|---------|---------|
|         | 400MHz    | 900MHz  | 1950MHz | 2450MHz |
| MAX2680 | 179-j356  | 54-j179 | 32-j94  | 33-j73  |
| MAX2681 | 209-j332  | 75-j188 | 34-j108 | 33-j86  |
| MAX2682 | 206-j306  | 78-j182 | 34-j106 | 29-j86  |

**Table 2. RF Input Impedance-Matching Component Values**

| MATCHING COMPONENTS | FREQUENCY |         |          |          |         |         |          |          |         |         |          |          |
|---------------------|-----------|---------|----------|----------|---------|---------|----------|----------|---------|---------|----------|----------|
|                     | MAX2680   |         |          |          | MAX2681 |         |          |          | MAX2682 |         |          |          |
|                     | 400 MHz   | 900 MHz | 1950 MHz | 2450 MHz | 400 MHz | 900 MHz | 1950 MHz | 2450 MHz | 400 MHz | 900 MHz | 1950 MHz | 2450 MHz |
| Z1                  | 86nH      | 270pF   | 1.5pF    | Short    | 68nH    | 270pF   | 1.5pF    | Short    | 68nH    | 1.5pF   | Short    | Short    |
| Z2                  | 270pF     | 22nH    | 270pF    | 270pF    | 270pF   | 18nH    | 270pF    | 270pF    | 270pF   | 270pF   | 270pF    | 270pF    |
| Z3                  | Open      | Open    | 1.8nH    | 1.8nH    | 0.5pF   | Open    | 1.8nH    | 2.2nH    | 0.5pF   | 10nH    | 2.2nH    | 1.2nH    |

**Note:** Z1, Z2, and Z3 are found in the *Typical Operating Circuit*.

### IF Output

The IF output frequency range extends from 10MHz to 500MHz. IFOUT is a high-impedance, open-collector output that requires an external inductor to VCC for proper biasing. For optimum performance, the IF port requires an impedance-matching network. The configuration and values for the matching network is dependent upon the frequency and desired output impedance. For assistance in choosing components for optimal performance, refer to Tables 3 and 4 as well as the IF Port Impedance vs. IF Frequency graph in the *Typical Operating Characteristics*.

### Power-Supply and $\overline{\text{SHDN}}$ Bypassing

Proper attention to voltage supply bypassing is essential for high-frequency RF circuit stability. Bypass VCC with a 10μF capacitor in parallel with a 1000pF capacitor. Use separate vias to the ground plane for each of the bypass capacitors and minimize trace length to reduce inductance. Use separate vias to the ground plane for each ground pin. Use low-inductance ground connections.

Decouple  $\overline{\text{SHDN}}$  with a 1000pF capacitor to ground to minimize noise on the internal bias cell. Use a series resistor (typically 100Ω) to reduce coupling of high-frequency signals into the SHDN pin.

### Layout Issues

A well designed PC board is an essential part of an RF circuit. For best performance, pay attention to power-supply issues as well as to the layout of the RFIN and IFOUT impedance-matching network.

# 400MHz to 2.5GHz, Low-Noise, SiGe Downconverter Mixers

**Table 3. IFOUT Port Impedance**

| PART    | FREQUENCY |          |          |
|---------|-----------|----------|----------|
|         | 45MHz     | 70MHz    | 240MHz   |
| MAX2680 | 960-j372  | 803-j785 | 186-j397 |
| MAX2681 | 934-j373  | 746-j526 | 161-j375 |
| MAX2682 | 670-j216  | 578-j299 | 175-j296 |

**Table 4. IF Output Impedance-Matching Components**

| MATCHING COMPONENT | FREQUENCY |       |        |
|--------------------|-----------|-------|--------|
|                    | 45MHz     | 70MHz | 240MHz |
| L1                 | 390nH     | 330nH | 82nH   |
| C2                 | 39pF      | 15pF  | 3pF    |
| R1                 | 250Ω      | Open  | Open   |

**Power-Supply Layout**

To minimize coupling between different sections of the IC, the ideal power-supply layout is a star configuration with a large decoupling capacitor at a central VCC node. The VCC traces branch out from this central node, each going to a separate VCC node on the PC board. At the end of each trace is a bypass capacitor that has low ESR at the RF frequency of operation. This arrangement provides local decoupling at the VCC pin. At high frequencies, any signal leaking out of one supply pin sees a relatively high impedance (formed by the VCC trace inductance) to the central VCC node, and an even higher impedance to any other supply pin, as well as a low impedance to ground through the bypass capacitor.

**Impedance-Matching Network Layout**

The RFIN and IFOUT impedance-matching networks are very sensitive to layout-related parasitics. To minimize parasitic inductance, keep all traces short and place components as close as possible to the chip. To minimize parasitic capacitance, use cutouts in the ground plane (and any other plane) below the matching network components. However, avoid cutouts that are larger than necessary since they act as aperture antennas.

**Typical Operating Circuit**

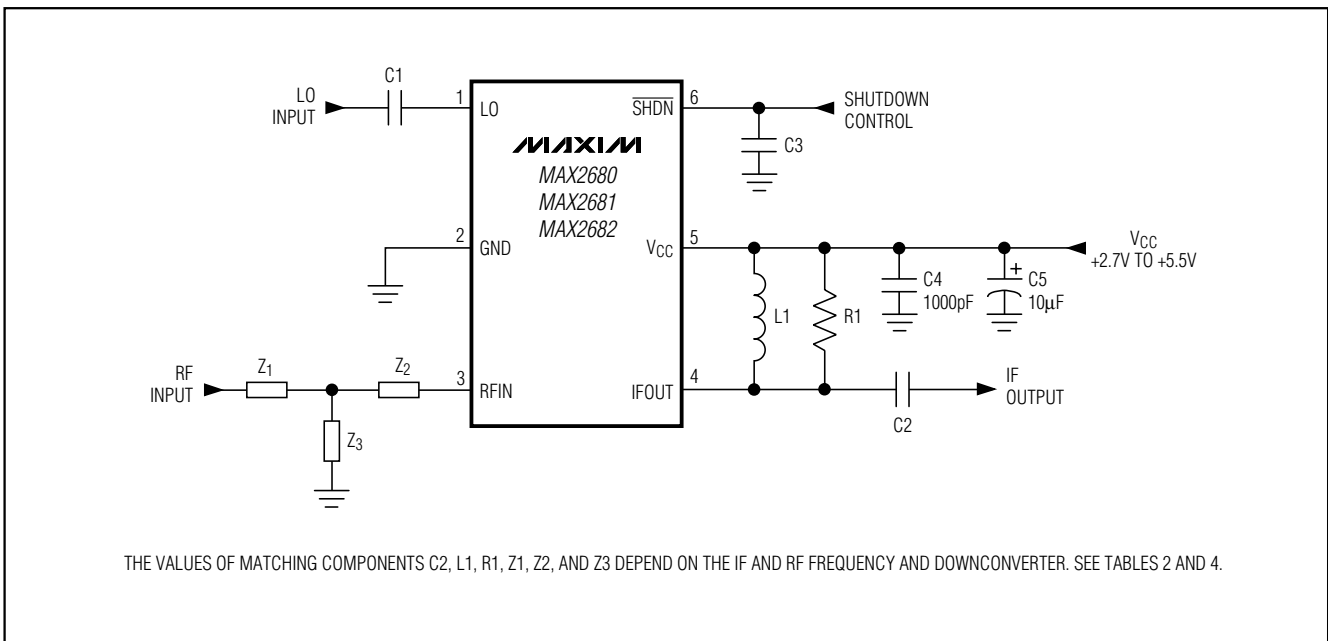

# 400MHz to 2.5GHz, Low-Noise, SiGe Downconverter Mixers

## Package Information

(The package drawing(s) in this data sheet may not reflect the most current specifications. For the latest package outline information go to [www.maxim-ic.com/packages](http://www.maxim-ic.com/packages).)

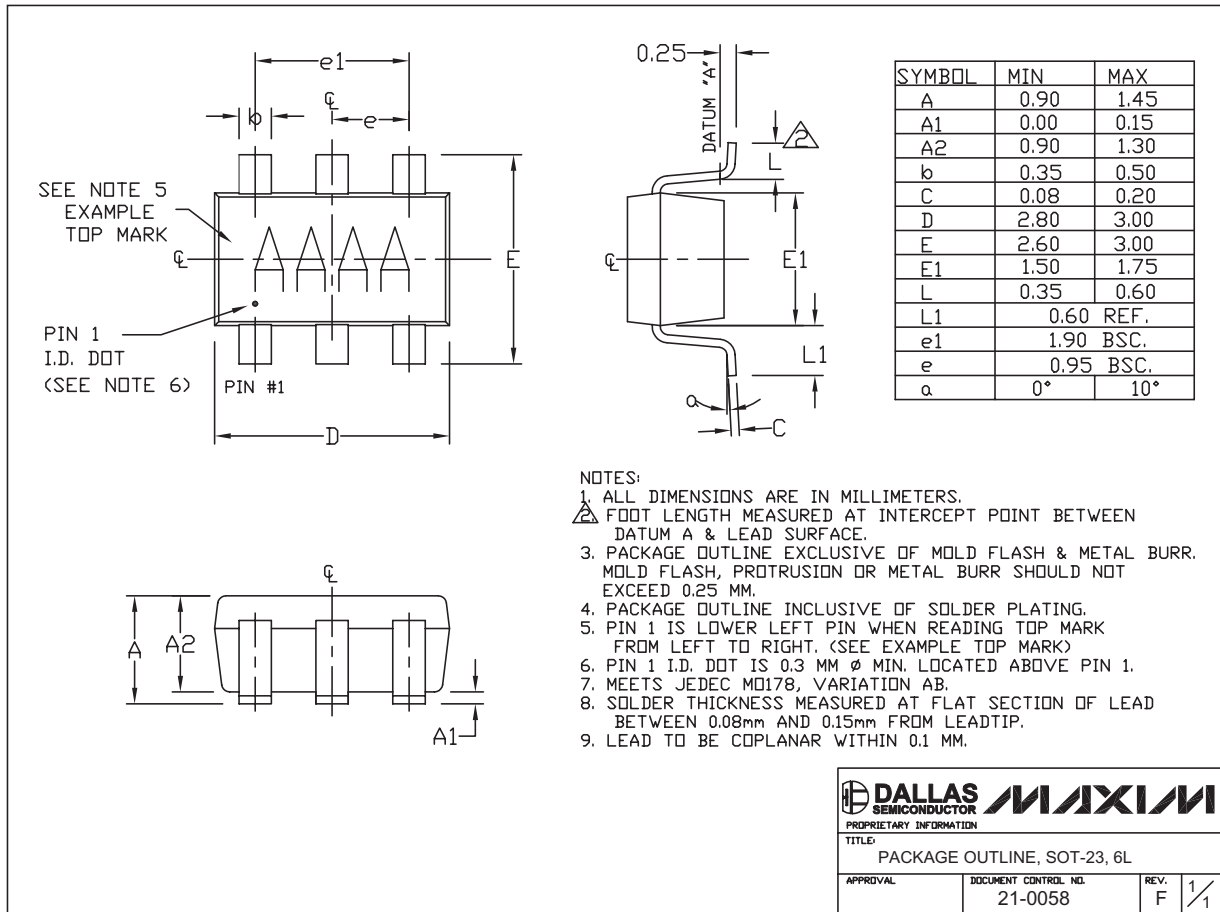

6LSOT.EPS

Maxim cannot assume responsibility for use of any circuitry other than circuitry entirely embodied in a Maxim product. No circuit patent licenses are implied. Maxim reserves the right to change the circuitry and specifications without notice at any time.

Maxim Integrated Products, 120 San Gabriel Drive, Sunnyvale, CA 94086 408-737-7600 \_\_\_\_\_ 11



## Стандарт Электрон Связь

Мы молодая и активно развивающаяся компания в области поставок электронных компонентов. Мы поставляем электронные компоненты отечественного и импортного производства напрямую от производителей и с крупнейших складов мира.

Благодаря сотрудничеству с мировыми поставщиками мы осуществляем комплексные и плановые поставки широчайшего спектра электронных компонентов.

Собственная эффективная логистика и склад в обеспечивает надежную поставку продукции в точно указанные сроки по всей России.

Мы осуществляем техническую поддержку нашим клиентам и предпродажную проверку качества продукции. На все поставляемые продукты мы предоставляем гарантию .

Осуществляем поставки продукции под контролем ВП МО РФ на предприятия военно-промышленного комплекса России , а также работаем в рамках 275 ФЗ с открытием отдельных счетов в уполномоченном банке. Система менеджмента качества компании соответствует требованиям ГОСТ ISO 9001.

Минимальные сроки поставки, гибкие цены, неограниченный ассортимент и индивидуальный подход к клиентам являются основой для выстраивания долгосрочного и эффективного сотрудничества с предприятиями радиоэлектронной промышленности, предприятиями ВПК и научно-исследовательскими институтами России.

С нами вы становитесь еще успешнее!

### Наши контакты:

**Телефон:** +7 812 627 14 35

**Электронная почта:** [sales@st-electron.ru](mailto:sales@st-electron.ru)

**Адрес:** 198099, Санкт-Петербург,  
Промышленная ул, дом № 19, литера Н,  
помещение 100-Н Офис 331