

IS31LT3172/73

10-TO-200MA CONSTANT-CURRENT LED DRIVER

July 2016

GENERAL DESCRIPTION

The IS31LT3172 and IS31LT3173 are adjustable linear current devices with excellent temperature stability. A single resistor is all that is required to set the operating current from 10mA to 200mA. The devices can operate from an input voltage from 2.5V to 42V with a minimal voltage headroom of 1V (typical). Designed with a low dropout voltage; the device can drive LED strings close to the supply voltage without switch capacitors or inductors.

The IS31LT3172/73 simplifies designs by providing a stable current without the additional requirement of input or output capacitors, inductors, FETs or diodes. The complete constant current driver requires only a current set resistor and a small PCB area making designs both efficient and cost effective.

The EN pin (3) of the IS31LT3172 can be tied to Vbat or BCM PWM signal for high side dimming. The EN Pin (3) of the IS31LT3173 can function as the PWM signal input used for low side dimming.

As a current sink it is ideal for LED lighting applications or current limiter for power supplies.

The device is provided in a lead (Pb) free, SOP-8-EP package.

FEATURES

- Low-side current sink
 - Current preset to 10mA
 - Adjustable from 10mA to 200mA with external resistor selection
- Wide input voltage range from
 - 2.5V to 42V (IS31LT3173)
 - 5V to 42V (IS31LT3172)
 with a low dropout of typical 1V
- Up to 10kHz PWM input (IS31LT3173 only)
- Protection features:
 - 0.26%/K negative temperature coefficient at high temp for thermal protection
- Up to 1.8W power dissipation in a small SOP-8-EP package
- RoHS compliant (Pb-free) package

APPLICATIONS

- Architectural LED lighting
- Channel letters for advertising, LED strips for decorative lighting
- Retail lighting in fridge, freezer case and vending machines
- Emergency lighting (e.g. steps lighting, exit way sign etc.)

TYPICAL APPLICATION CIRCUIT

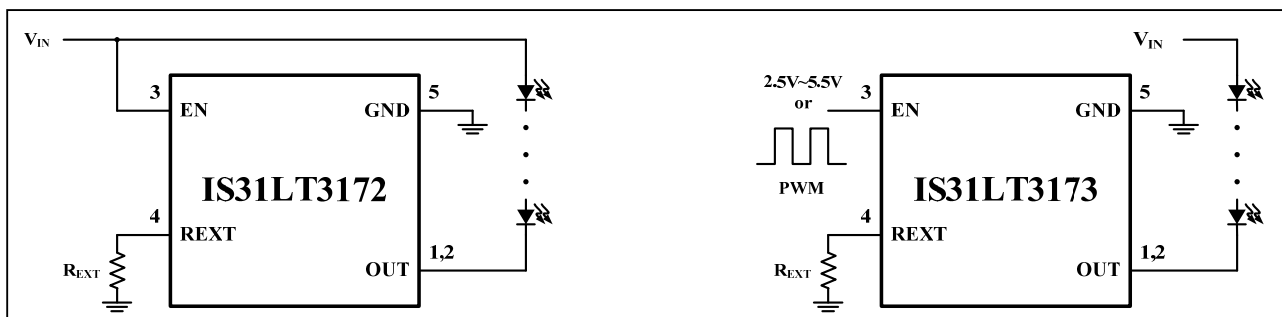
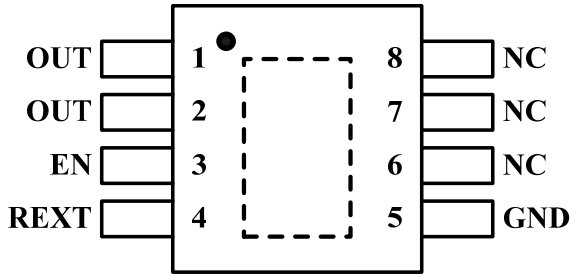

Figure 1 Typical Application Circuit

IS31LT3172/73

PIN CONFIGURATION

Package	Pin Configuration (Top View)
SOP-8-EP	

PIN DESCRIPTION

No.	Pin	Description
1, 2	OUT	Current sink.
3	EN	Enable pin (PWM input IS31LT3173 only).
4	REXT	Optional current adjust.
5	GND	Ground.
6 ~ 8	NC	Floating or connect to GND.
	Thermal Pad	Connect to GND.



IS31LT3172/73

ORDERING INFORMATION

Industrial Range: -40°C to +125°C

Order Part No.	Package	QTY/Reel
IS31LT3172-GRLS4-TR IS31LT3173-GRLS4-TR	SOP-8-EP, Lead-free	2500

Copyright © 2016 Integrated Silicon Solution, Inc. All rights reserved. ISSI reserves the right to make changes to this specification and its products at any time without notice. ISSI assumes no liability arising out of the application or use of any information, products or services described herein. Customers are advised to obtain the latest version of this device specification before relying on any published information and before placing orders for products. Integrated Silicon Solution, Inc. does not recommend the use of any of its products in life support applications where the failure or malfunction of the product can reasonably be expected to cause failure of the life support system or to significantly affect its safety or effectiveness. Products are not authorized for use in such applications unless Integrated Silicon Solution, Inc. receives written assurance to its satisfaction, that:

- a.) the risk of injury or damage has been minimized;
- b.) the user assume all such risks; and
- c.) potential liability of Integrated Silicon Solution, Inc is adequately protected under the circumstances

IS31LT3172/73

ABSOLUTE MAXIMUM RATINGS (Note 1)

Maximum enable voltage, $V_{EN(MAX)}$ only for IS31LT3172-GRLS4-TR $V_{EN(MAX)}$ only for IS31LT3173-GRLS4-TR	45V 6V
Maximum output current, $I_{OUT(MAX)}$	200mA
Maximum output voltage, $V_{OUT(MAX)}$	45V
Reverse voltage between all terminals, V_R	0.5V
Power dissipation, $P_{D(MAX)}$ (Note 2)	1.8W
Maximum junction temperature, T_{JMAX}	150°C
Storage temperature range, T_{STG}	-65°C ~ +150°C
Operating temperature range, T_A	-40°C ~ +125°C
ESD (HBM) IS31LT3172-GRLS4-TR	±2kV
ESD (HBM) IS31LT3173-GRLS4-TR	±1.5kV
ESD (CDM)	±500V

Note 1:

Stresses beyond those listed under “Absolute Maximum Ratings” may cause permanent damage to the device. These are stress ratings only and functional operation of the device at these or any other condition beyond those indicated in the operational sections of the specifications is not implied. Exposure to absolute maximum rating conditions for extended periods may affect device reliability.

Note 2:

Detail information please refer to package thermal de-rating curve on Page 14.

THERMAL CHARACTERISTICS

Characteristic	Test Conditions	Value
Package Thermal Resistance (Junction to Ambient), $R_{\theta JA}$	On 4-layer PCB based on JEDEC standard at 1W, $T_A=25^\circ\text{C}$	55.4°C/W
Package Thermal Resistance (Junction to Pad), $R_{\theta JP}$		2.24°C/W

ELECTRICAL CHARACTERISTICS

“●” This symbol in the table means these parameters are for IS31LT3172-GRLS4-TR.

“○” This symbol in the table means these parameters are for IS31LT3173-GRLS4-TR.

Test condition is $T_A = T_J = 25^\circ\text{C}$, unless otherwise specified. (Note 3)

Symbol	Parameter	Condition	Min.	Typ.	Max.	Unit	
V_{BD_OUT}	OUT pin breakdown voltage	$V_{EN} = 0V$		42		V	
I_{EN}	Enable current	$V_{EN} = 24V$	●		0.35	Ma	
		$V_{EN} = 3.3V$	○		0.35		
R_{INT}	Internal resistor	$I_{RINT} = 10\text{Ma}$			106	Ω	
I_{OUT}	Output current	$V_{OUT} = 1.4V, V_{EN} = 24V, R_{EXT} \text{ OPEN}$	●	9	10	11	Ma
		$V_{OUT} = 1.4V, V_{EN} = 3.3V, R_{EXT} \text{ OPEN}$	○	9	10	11	
		$V_{OUT} > 2.0V, V_{EN} = 24V, R_{EXT} = 10\Omega$	●	105	118	130	Ma
		$V_{OUT} > 2.0V, V_{EN} = 3.3V, R_{EXT} = 10\Omega$	○	105	118	130	
Output current Range (Note 4, 5)	$V_{OUT} > 2.0V, V_{EN} = 24V$	●	10		200	Ma	
	$V_{OUT} > 2.0V, V_{EN} = 3.3V$	○	10		200		

IS31LT3172/73

DC CHARACTERISTICS WITH STABILIZED LED LOAD

“●” This symbol in the table means these parameters are for IS31LT3172-GRLS4-TR.

“○” This symbol in the table means these parameters are for IS31LT3173-GRLS4-TR.

Test condition is $T_A = T_J = 25^\circ\text{C}$, unless otherwise specified. (Note 3)

Symbol	Parameter	Condition		Min.	Typ.	Max.	Unit
V_S	Sufficient supply voltage on EN pin		●	5		42	V
			○	2.5		5.5	
V_{HR}	Lowest sufficient headroom voltage on OUT pin	$I_{OUT} = 100\text{Ma}$			1	1.2	V
$\Delta I_{OUT}/I_{OUT}$ (Note 4)	Output current change versus ambient temp change	$V_{OUT} > 2.0\text{V}, V_{EN} = 24\text{V}, R_{EXT} = 10\Omega$	●		-0.26		%K
			○		-0.26		
	Output current change versus V_{out}	$V_{OUT} > 2.0\text{V}, V_{EN} = 24\text{V}, R_{EXT} = 10\Omega$	●		1.9		%V
			○		1.9		

Note 3:

Production testing of the device is performed at 25°C . Functional operation of the device and parameters specified over -40°C to $+125^\circ\text{C}$ temperature range, are guaranteed by design and characterization.

Note 4:

Guaranteed by design.

Note 5:

The maximum output current is dependent on the PCB board design, air flow, ambient temperature and power dissipation in the device. Please refer to the package thermal de-rating curve on Page 14 for more detail information.

IS31LT3172/73

FUNCTIONAL BLOCK DIAGRAM

IS31LT3172

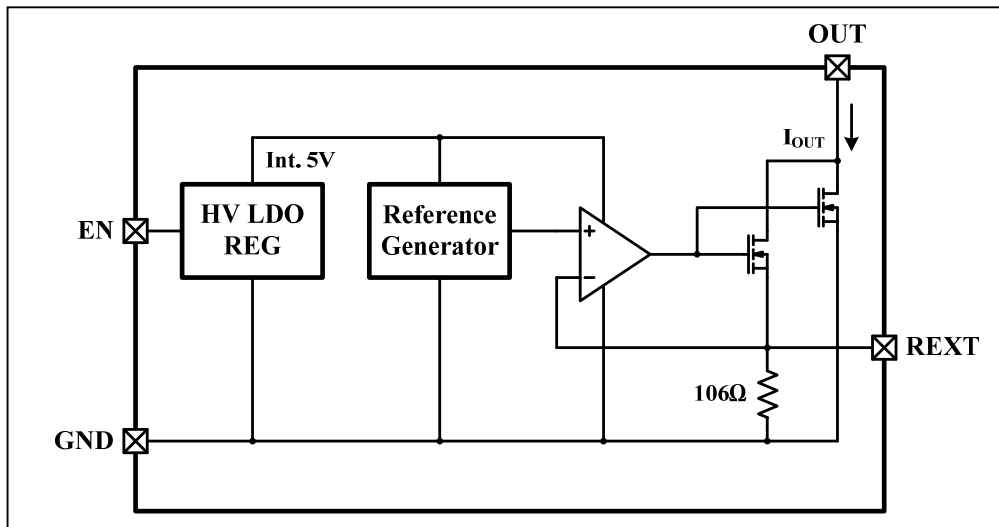

IS31LT3173

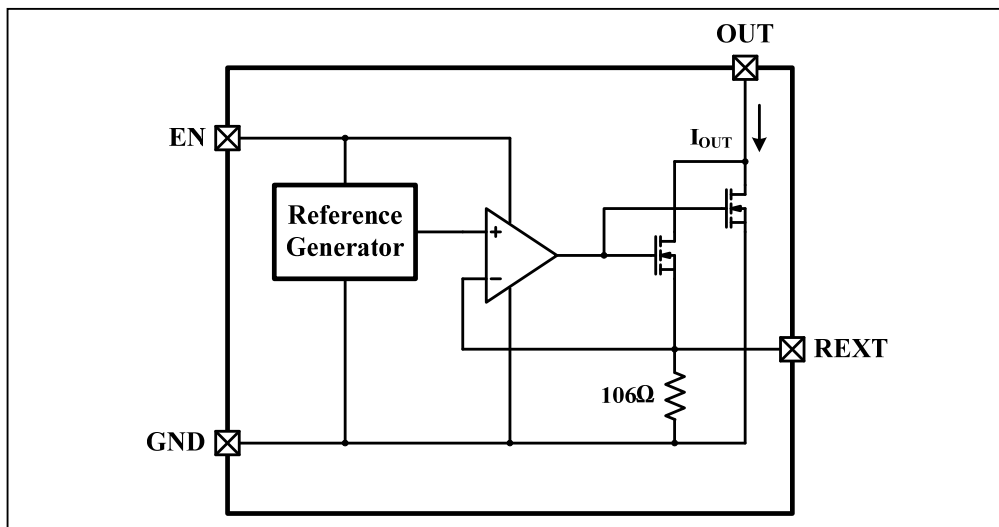

IS31LT3172/73

TYPICAL PERFORMANCE CHARACTERISTICS

IS31LT3172

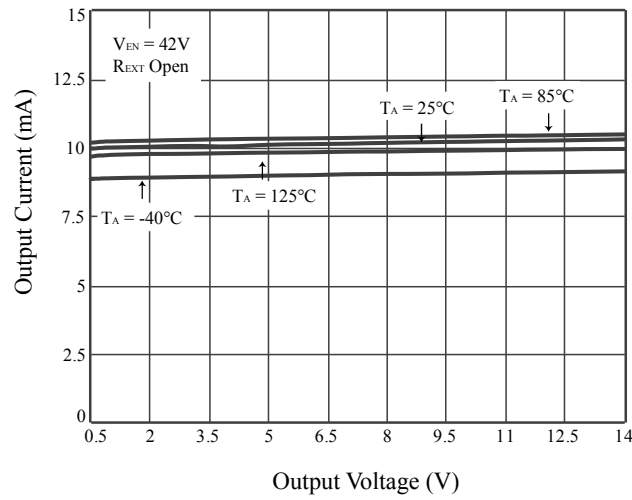

Figure 2 I_{OUT} vs. V_{OUT}

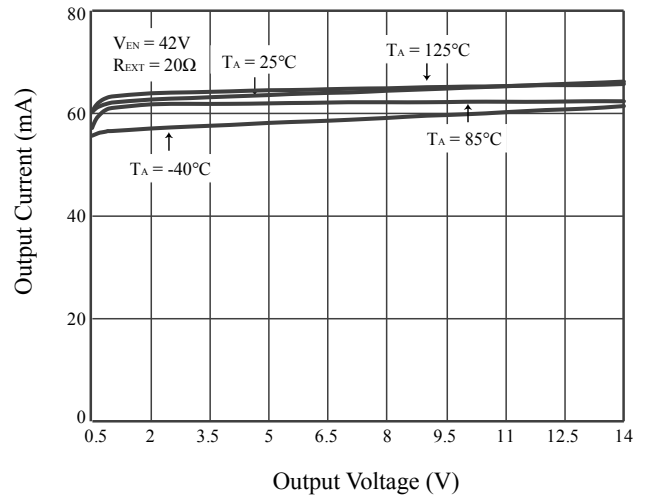

Figure 3 I_{OUT} vs. V_{OUT}

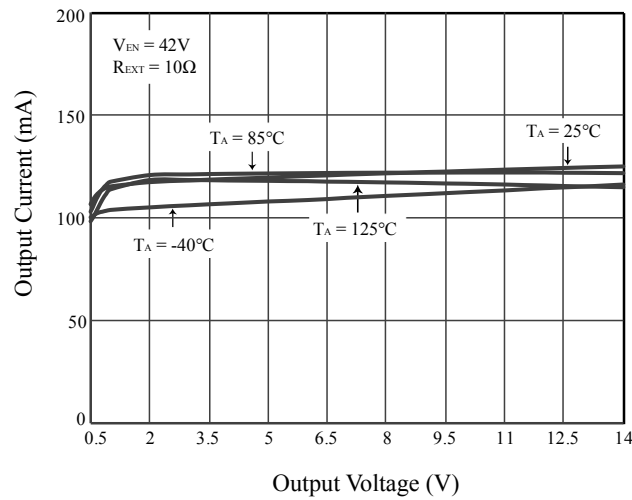

Figure 4 I_{OUT} vs. V_{OUT}

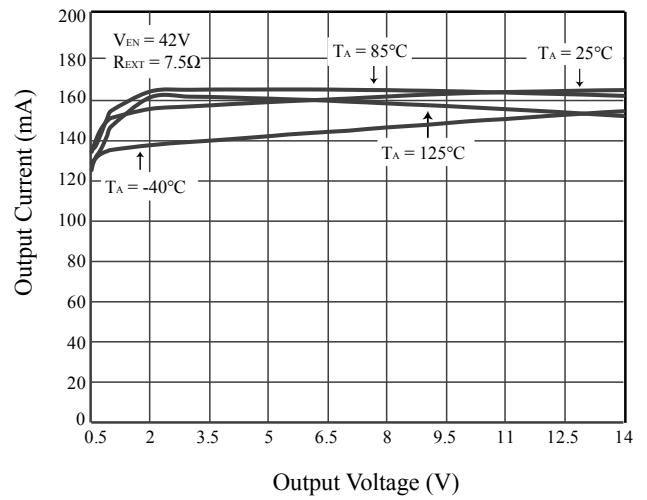

Figure 5 I_{OUT} vs. V_{OUT}

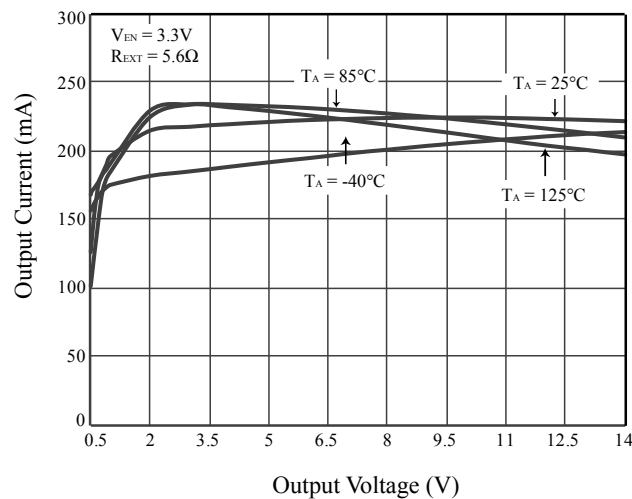

Figure 6 I_{OUT} vs. V_{OUT}

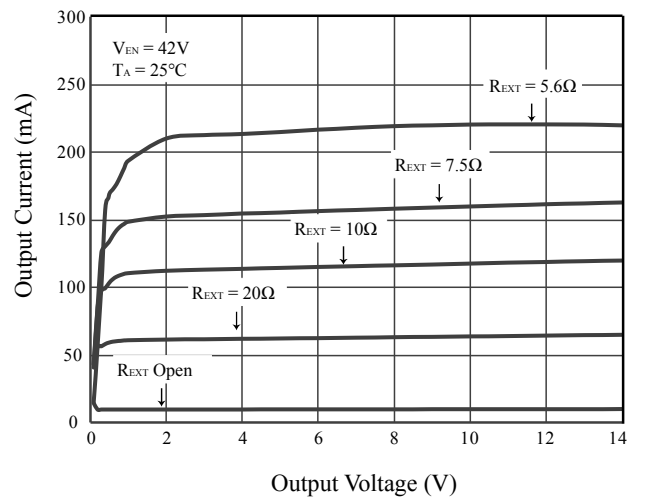

Figure 7 I_{OUT} vs. V_{OUT}

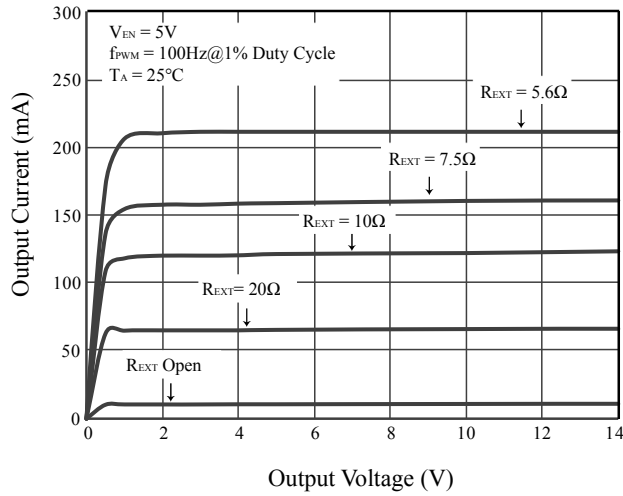

Figure 8 I_{OUT} vs. V_{OUT}

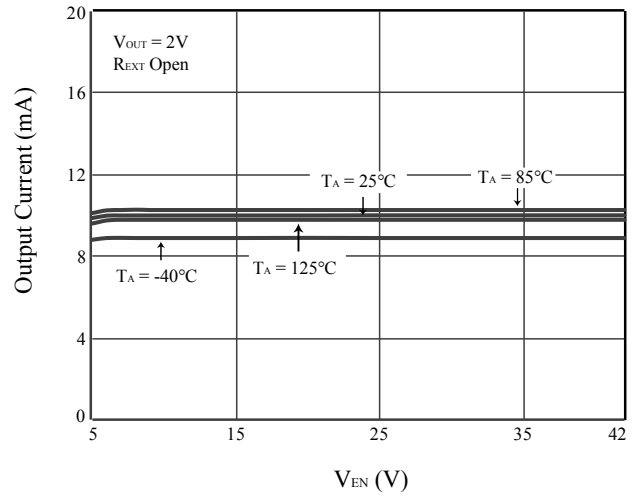

Figure 9 I_{OUT} vs. V_{EN}

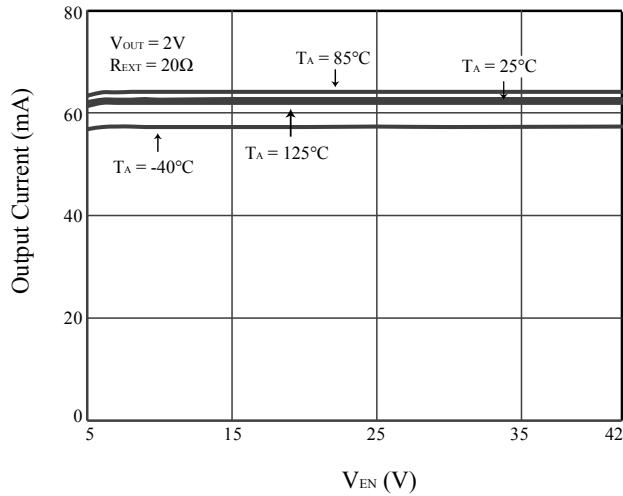

Figure 10 I_{OUT} vs. V_{EN}

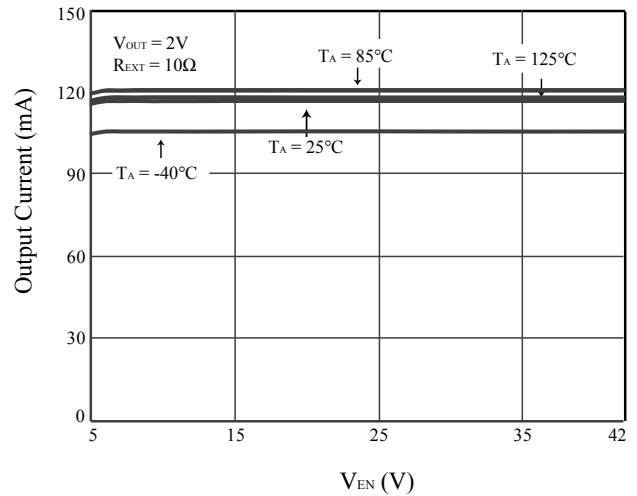

Figure 11 I_{OUT} vs. V_{EN}

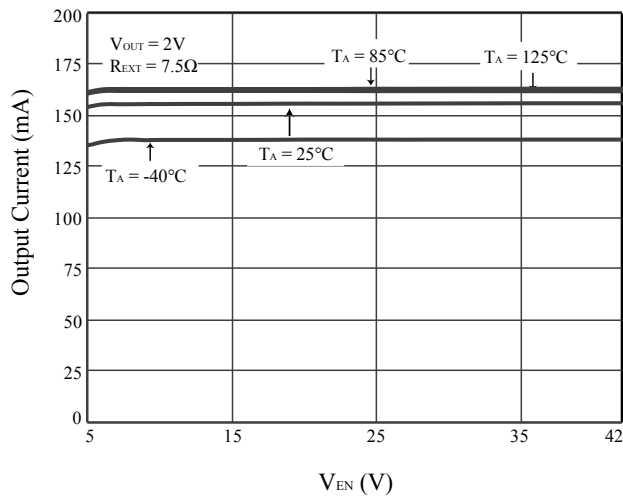

Figure 12 I_{OUT} vs. V_{EN}

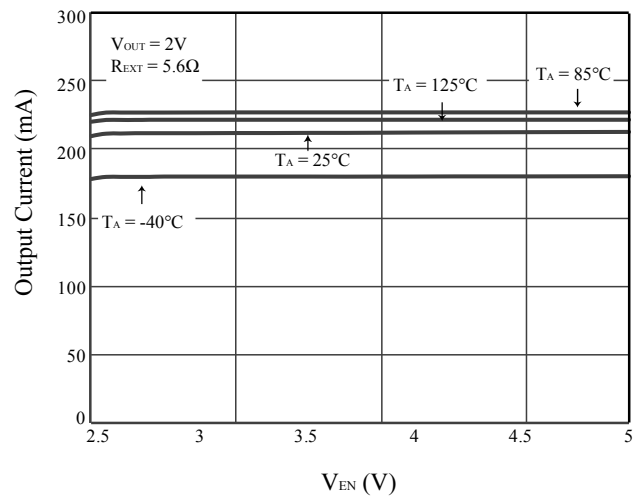

Figure 13 I_{OUT} vs. V_{EN}

IS31LT3172/73

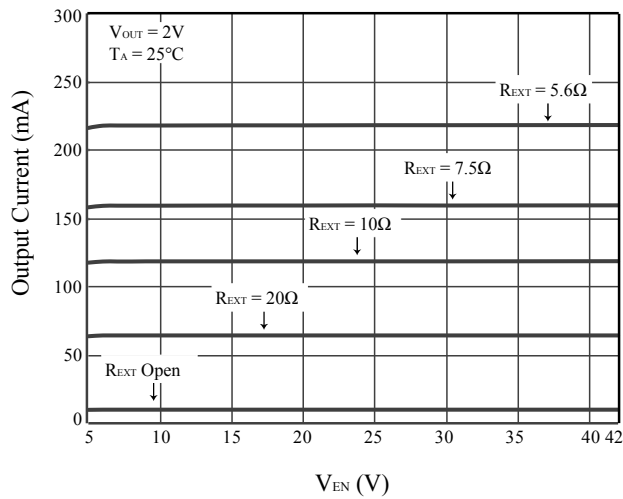

Figure 14 I_{OUT} vs. V_{EN}

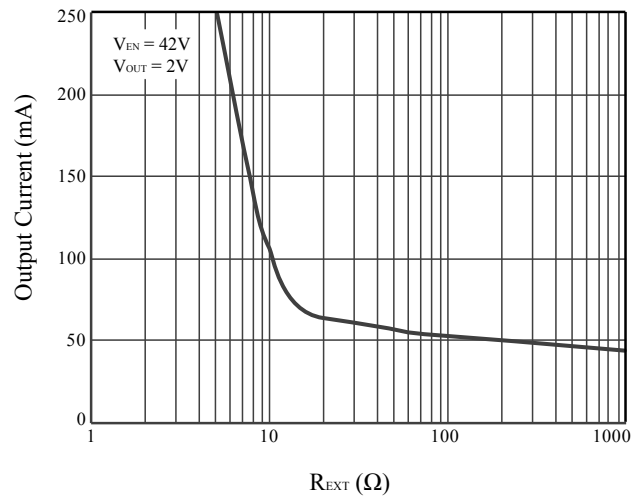

Figure 15 I_{OUT} vs. R_{EXT}

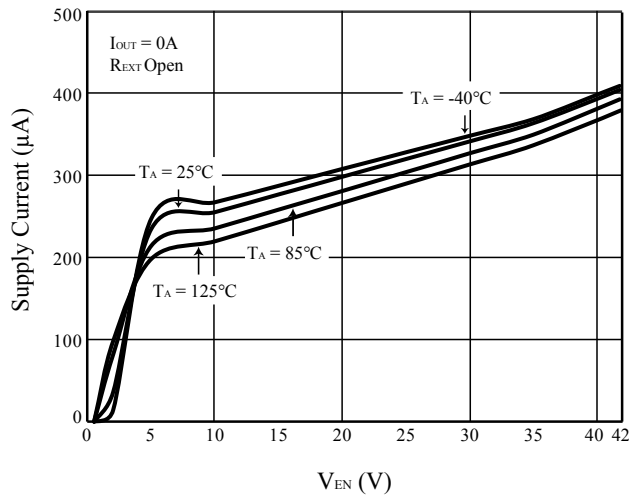

Figure 16 I_{EN} vs. V_{EN}

IS31LT3172/73

IS31LT3173

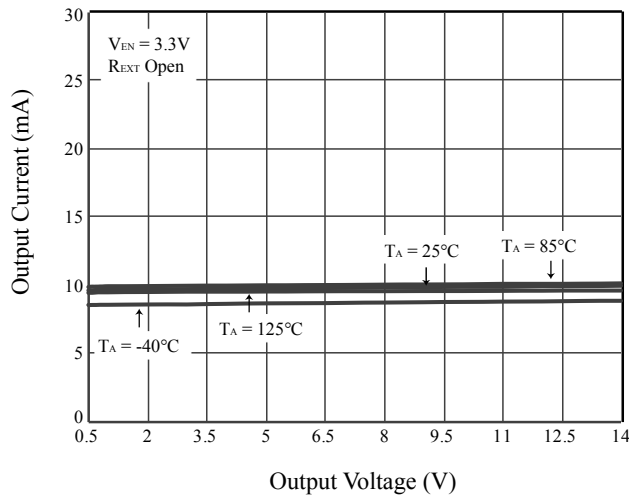

Figure 17 I_{OUT} vs. V_{OUT}

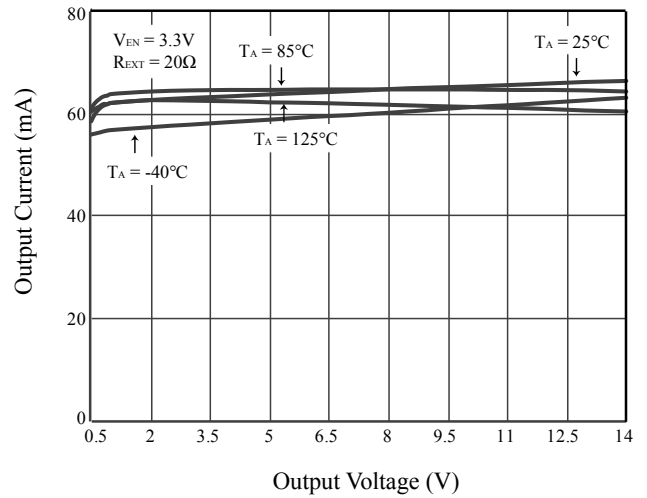

Figure 18 I_{OUT} vs. V_{OUT}

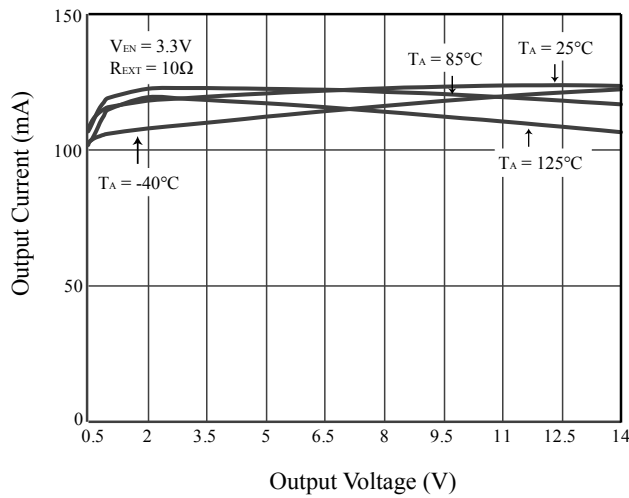

Figure 19 I_{OUT} vs. V_{OUT}

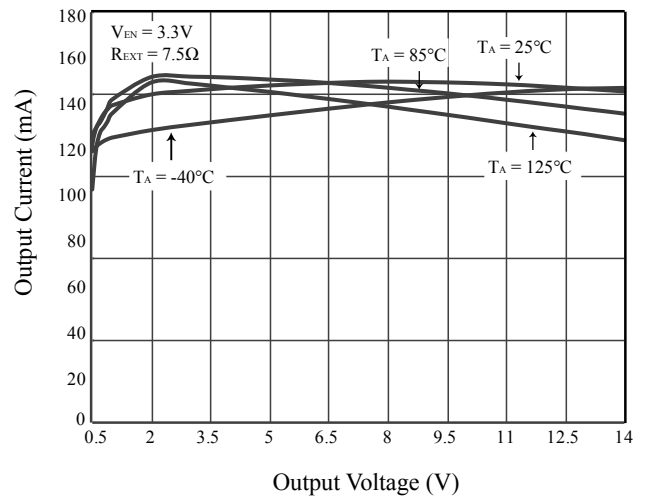

Figure 20 I_{OUT} vs. V_{OUT}

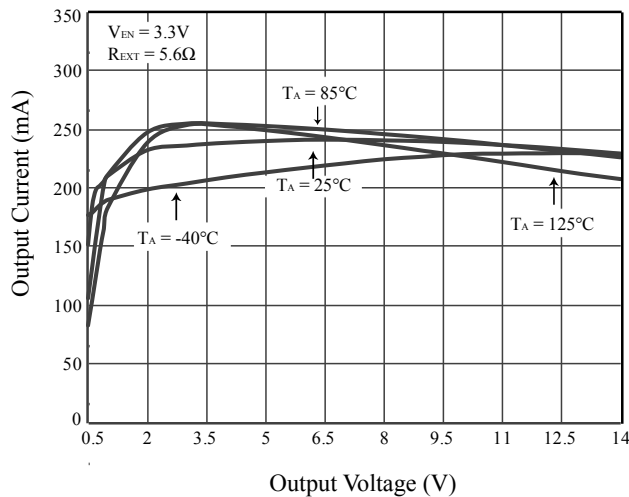

Figure 21 I_{OUT} vs. V_{OUT}

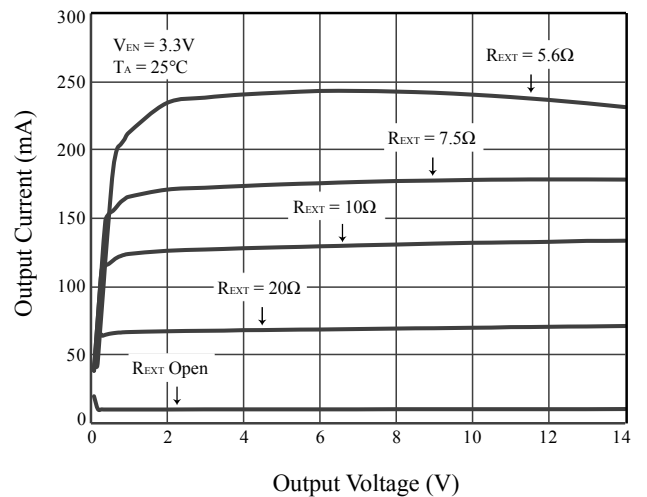

Figure 22 I_{OUT} vs. V_{OUT}

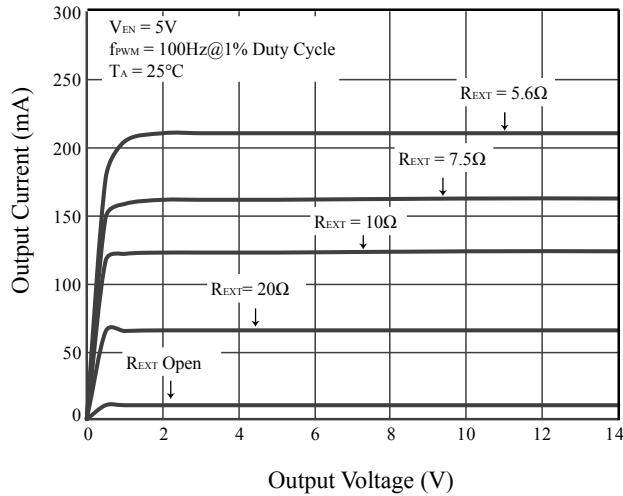

Figure 23 I_{OUT} vs. V_{OUT}

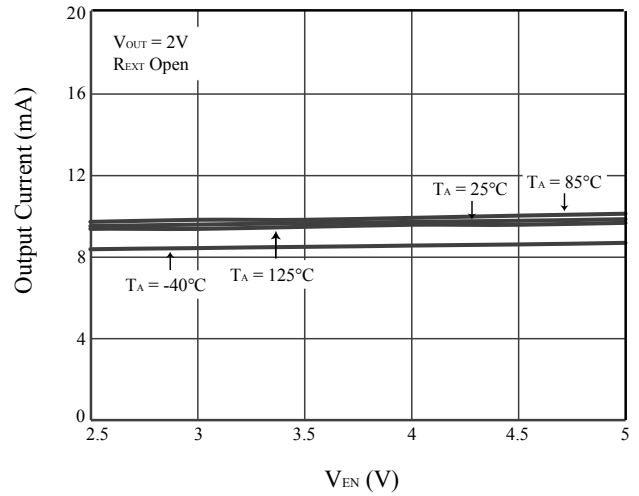

Figure 24 I_{OUT} vs. V_{EN}

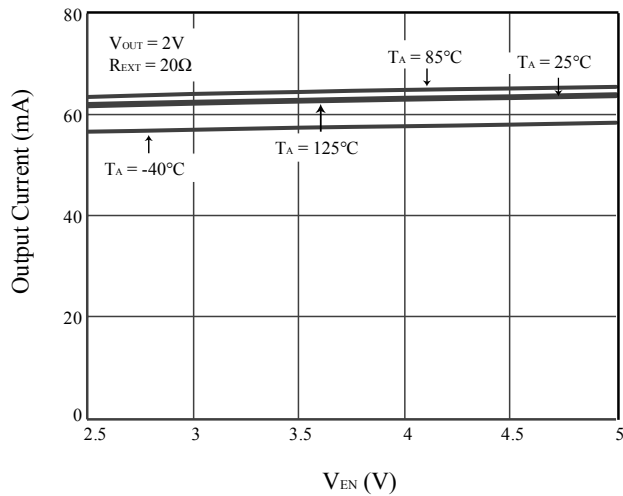

Figure 25 I_{OUT} vs. V_{EN}

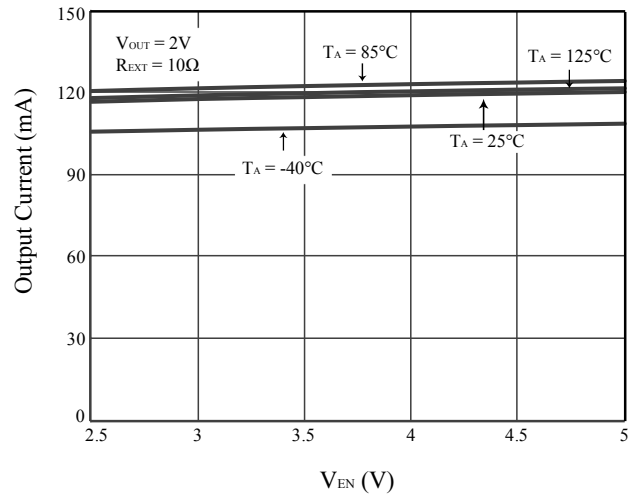

Figure 26 I_{OUT} vs. V_{EN}

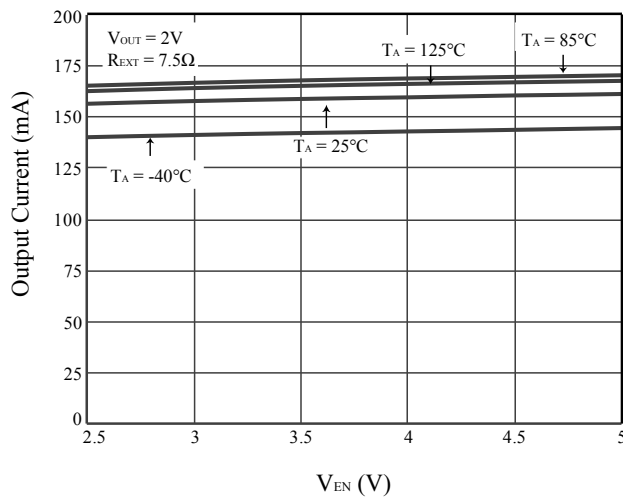

Figure 27 I_{OUT} vs. V_{EN}

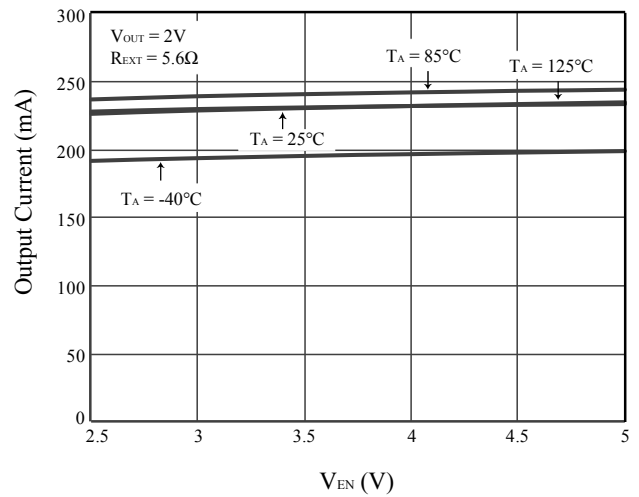

Figure 28 I_{OUT} vs. V_{EN}

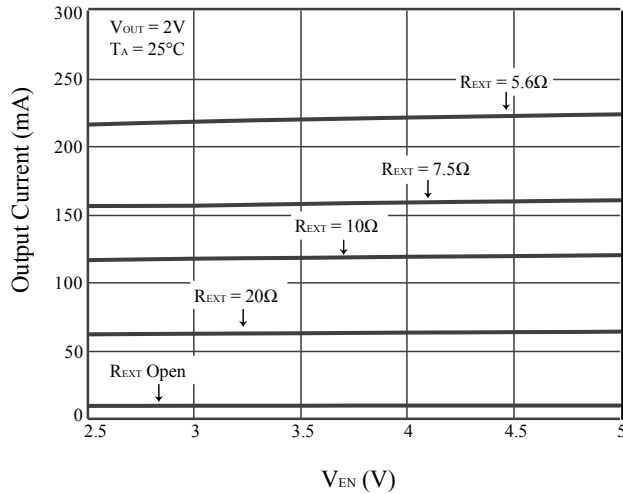

Figure 29 I_{OUT} vs. V_{EN}

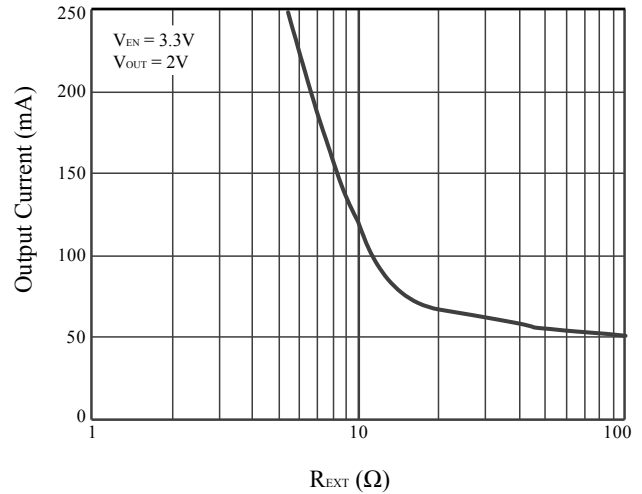

Figure 30 I_{OUT} vs. R_{EXT}

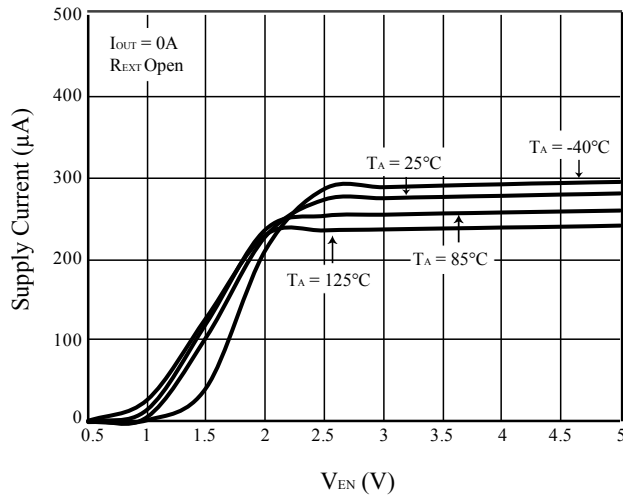

Figure 31 I_{EN} vs. V_{EN}

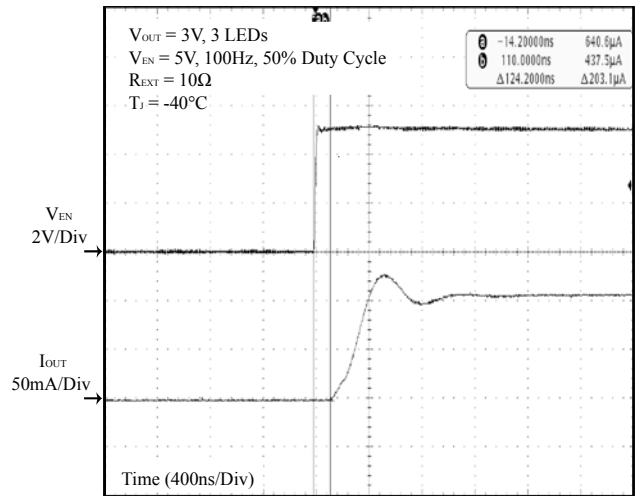

Figure 32 V_{EN} vs. I_{OUT} Delay and Rising Edge

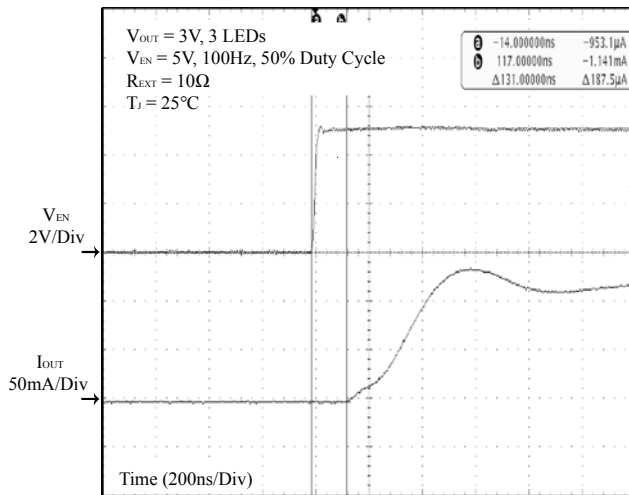

Figure 33 V_{EN} vs. I_{OUT} Delay and Rising Edge

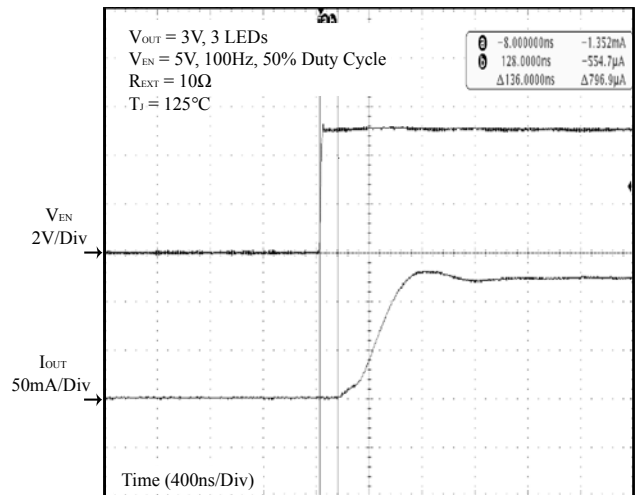

Figure 34 V_{EN} vs. I_{OUT} Delay and Rising Edge

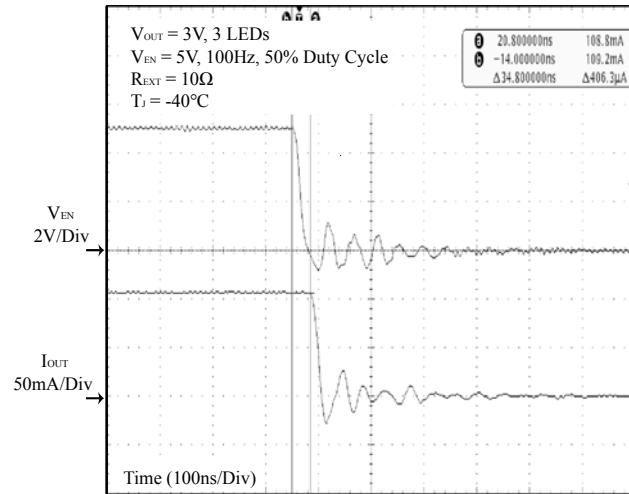

Figure 35 V_{EN} vs. I_{OUT} Delay and Falling Edge

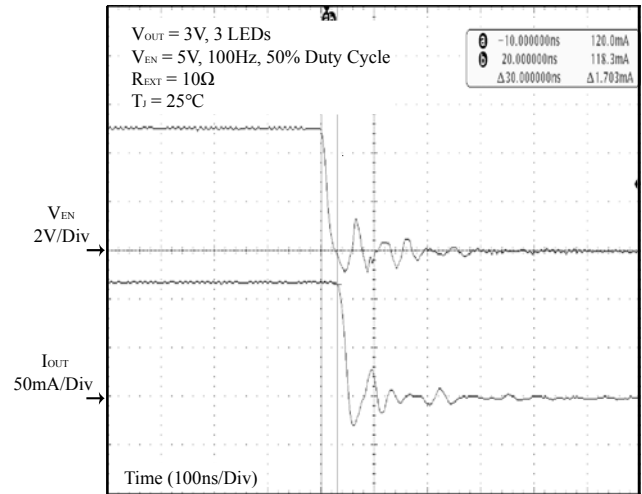

Figure 36 V_{EN} vs. I_{OUT} Delay and Falling Edge

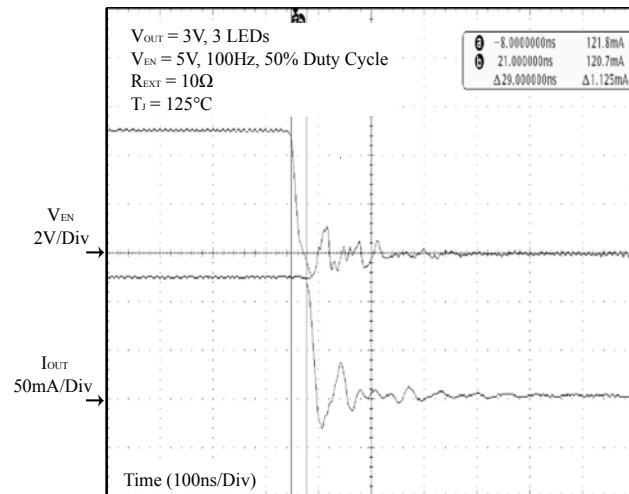

Figure 37 V_{EN} vs. I_{OUT} Delay and Falling Edge

IS31LT3172/73

APPLICATIONS INFORMATION

IS31LT3172/73 provides an easy constant current source solution for LED lighting applications. It uses an external resistor to adjust the LED current from 10Ma to 200Ma. The LED current can be determined by the external resistor R_{EXT} as Equation (1):

$$R_{EXT} = \frac{10mA \times 106\Omega}{I_{SET} - 10mA} \quad (1)$$

Where I_{SET} is in Ma.

Paralleling a low tolerance resistor R_{EXT} with the internal resistor R_{INT} will improve the overall accuracy of the current sense resistance. The resulting output current will vary slightly lower due to the negative temperature coefficient (NTC) resulting from the self heating of the IS31LT3172/73.

HIGH INPUT VOLTAGE APPLICATION

When driving a long string of LEDs whose total forward voltage drop exceeds the IS31LT3172 V_{BD_OUT} limit of 42V, it is possible to stack several LEDs (such as 2 LEDs) between the EN pin and the OUT pins, and so the voltage on the EN pin is higher than 5V. The remaining string of LEDs can then be placed between power supply $+V_S$ and EN pin, (Figure 38). The number of LEDs required to stack at EN pin will depend on the LED's forward voltage drop (V_F) and the $+V_S$ value.

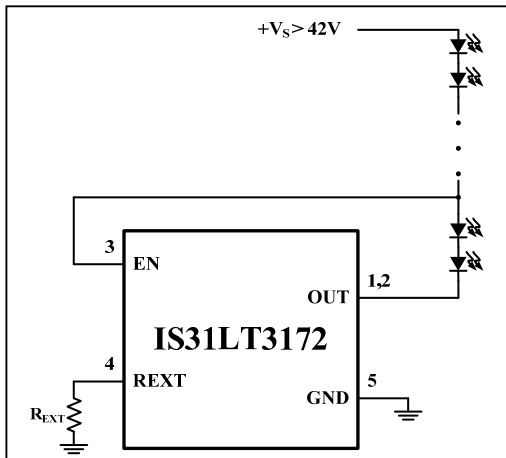

Figure 38 High Input Voltage Application Circuit

Note: when operating the IS31LT3172 at voltages exceeding the device operating limits, care needs to be taken to keep the EN pin and OUT pin voltage below 42V.

THERMAL PROTECTION AND DISSIPATION

The IS31LT3172/73 implements thermal foldback protection to reduce the LED current when the package's thermal dissipation is exceeded and prevent "thermal runaway". The thermal foldback implements a negative temperature coefficient (NTC) of $-0.26\%/K$.

When operating the chip at high ambient temperatures, or when driving maximum load current, care must be taken to avoid exceeding the package power dissipation limits. Exceeding the package dissipation will cause the device to enter thermal protection mode. The maximum package power dissipation can be calculated using the following Equation (2):

$$P_{D(MAX)} = \frac{T_{J(MAX)} - T_A}{\theta_{JA}} \quad (2)$$

Where $T_{J(MAX)}$ is the maximum junction temperature, T_A is the ambient temperature, and θ_{JA} is the junction to ambient thermal resistance; a metric for the relative thermal performance of a package.

The recommended maximum operating junction temperature, $T_{J(MAX)}$, is $125^\circ C$ and so the maximum ambient temperature is determined by the package parameter; θ_{JA} . The θ_{JA} for the IS31LT3172/73 SOP-8-EP package is $55.4^\circ C/W$.

Therefore the maximum power dissipation at $T_A = 25^\circ C$ is:

$$P_{D(MAX)} = \frac{125^\circ C - 25^\circ C}{55.4^\circ C/W} \approx 1.8W$$

The actual power dissipation P_D is:

$$P_D = V_{OUT} \times I_{OUT} + V_{EN} \times I_{EN} \quad (3)$$

To ensure the performance, the die temperature (T_J) of the IS31LT3172/73 should not exceed $125^\circ C$. The graph below gives details for the package power derating.

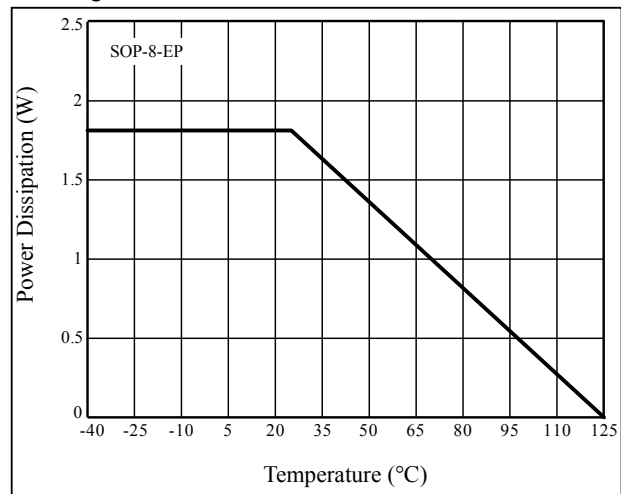

Figure 39 P_D vs. T_A (SOP-8-EP)

The thermal resistance is achieved by mounting the IS31LT3172/73 on a standard FR4 double-sided printed circuit board (PCB) with a copper area of a few square inches on each side of the board under

IS31LT3172/73

the IS31LT3172/73. Multiple thermal vias, as shown in Figure 40, help to conduct the heat from the exposed pad of the IS31LT3172/73 to the copper on each side of the board. The thermal resistance can be reduced by using a metal substrate or by adding a heatsink.

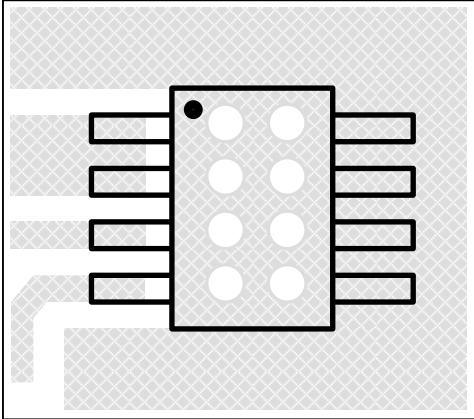

Figure 40 Board Via Layout For Thermal Dissipation

IS31LT3172/73

CLASSIFICATION REFLOW PROFILES

Profile Feature	Pb-Free Assembly
Preheat & Soak	
Temperature min (T _{smin})	150°C
Temperature max (T _{smax})	200°C
Time (T _{smin} to T _{smax}) (t _s)	60-120 seconds
Average ramp-up rate (T _{smax} to T _p)	3°C/second max.
Liquidous temperature (T _L)	217°C
Time at liquidous (T _L)	60-150 seconds
Peak package body temperature (T _p)*	Max 260°C
Time (t _p)** within 5°C of the specified classification temperature (T _c)	Max 30 seconds
Average ramp-down rate (T _p to T _{smax})	6°C/second max.
Time 25°C to peak temperature	8 minutes max.

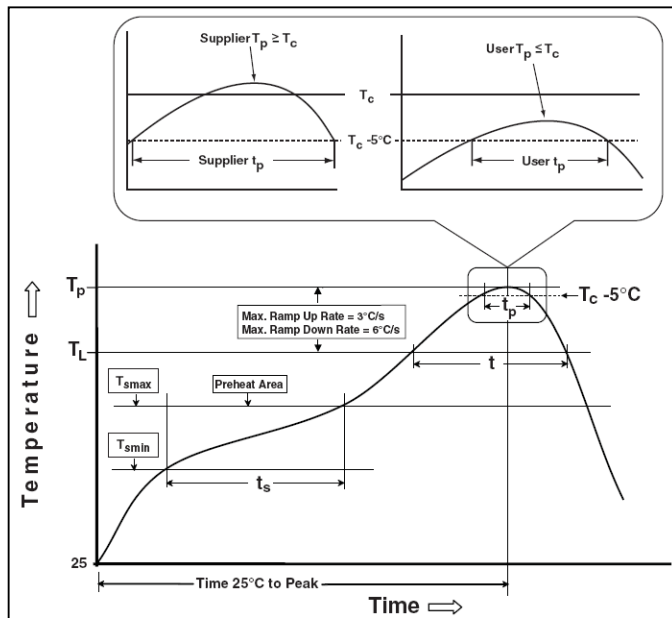
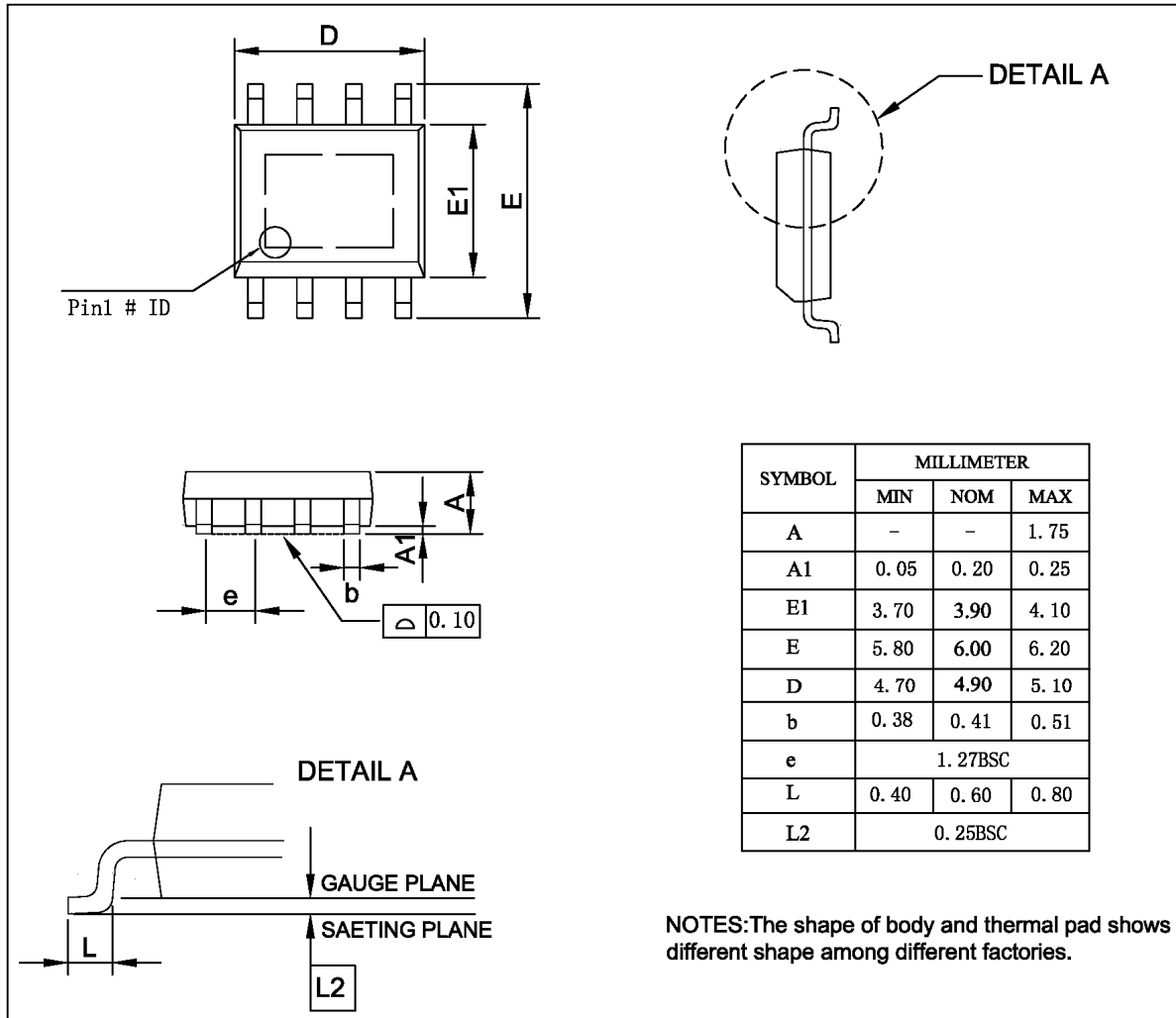

Figure 41 Classification Profile

IS31LT3172/73

PACKAGE INFORMATION

SOP-8-EP



IS31LT3172/73

RECOMMENDED LAND PATTERN

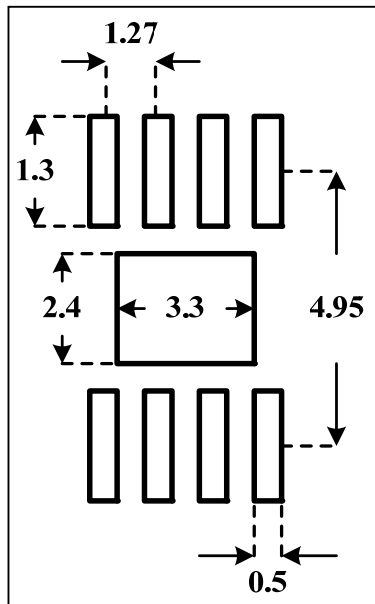

Note:

1. Land pattern complies to IPC-7351.
2. All dimensions in MM.
3. This document (including dimensions, notes & specs) is a recommendation based on typical circuit board manufacturing parameters. Since land pattern design depends on many factors unknown (eg. User's board manufacturing specs), user must determine suitability for use.



IS31LT3172/73

REVISION HISTORY

Revision	Detail Information	Date
A	Initial release	2016.03.01
B	Update EC table	2016.05.04
C	Add Package Thermal Resistance (Junction to Pad), $R_{\theta JP}$ in THERMAL CHARACTERISTICS	2016.07.01



**Стандарт
Электрон
Связь**

Мы молодая и активно развивающаяся компания в области поставок электронных компонентов. Мы поставляем электронные компоненты отечественного и импортного производства напрямую от производителей и с крупнейших складов мира.

Благодаря сотрудничеству с мировыми поставщиками мы осуществляем комплексные и плановые поставки широчайшего спектра электронных компонентов.

Собственная эффективная логистика и склад в обеспечивает надежную поставку продукции в точно указанные сроки по всей России.

Мы осуществляем техническую поддержку нашим клиентам и предпродажную проверку качества продукции. На все поставляемые продукты мы предоставляем гарантию .

Осуществляем поставки продукции под контролем ВП МО РФ на предприятия военно-промышленного комплекса России , а также работаем в рамках 275 ФЗ с открытием отдельных счетов в уполномоченном банке. Система менеджмента качества компании соответствует требованиям ГОСТ ISO 9001.

Минимальные сроки поставки, гибкие цены, неограниченный ассортимент и индивидуальный подход к клиентам являются основой для выстраивания долгосрочного и эффективного сотрудничества с предприятиями радиоэлектронной промышленности, предприятиями ВПК и научно-исследовательскими институтами России.

С нами вы становитесь еще успешнее!

Наши контакты:

Телефон: +7 812 627 14 35

Электронная почта: sales@st-electron.ru

Адрес: 198099, Санкт-Петербург,
Промышленная ул, дом № 19, литера Н,
помещение 100-Н Офис 331