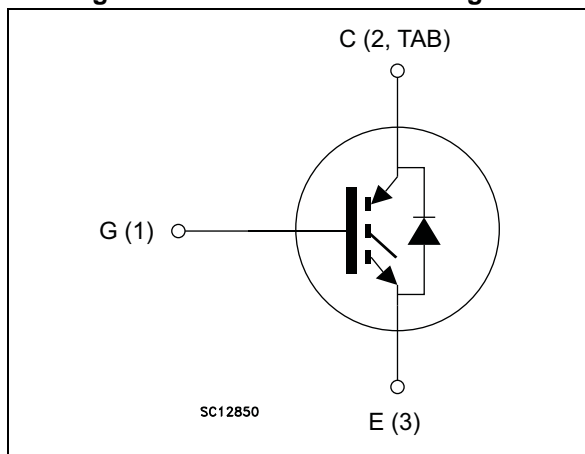

Figure 1. Internal schematic diagram



Features

- Maximum junction temperature: $T_J = 175\text{ °C}$
- High speed switching series
- Minimized tail current
- $V_{CE(sat)} = 1.6\text{ V (typ.) @ } I_C = 60\text{ A}$
- Tight parameters distribution
- Safe paralleling
- Low thermal resistance
- Very fast soft recovery antiparallel diode

Applications

- Photovoltaic inverters
- High frequency converters

Description

These are IGBT devices developed using an advanced proprietary trench gate and field-stop structure. The devices are part of the new HB series of IGBTs, which represent an optimum compromise between conduction and switching losses to maximize the efficiency of any frequency converter. Furthermore, a slightly positive $V_{CE(sat)}$ temperature coefficient and very tight parameter distribution result in safer paralleling operation.

Table 1. Device summary

Order code	Marking	Package	Packing
STGW60H65DFB	GW60H65DFB	TO-247	Tube
STGWA60H65DFB	G60H65DFB	TO-247 long leads	Tube
STGWT60H65DFB	GWT60H65DFB	TO-3P	Tube

Contents

1	Electrical ratings	3
2	Electrical characteristics	4
2.1	Electrical characteristics (curves)	6
3	Test circuits	11
4	Package information	12
4.1	TO-247 package information	12
4.2	TO-247 long leads package information	14
4.3	TO-3P package information	16
5	Revision history	18

1 Electrical ratings

Table 2. Absolute maximum ratings

Symbol	Parameter	Value	Unit
V_{CES}	Collector-emitter voltage ($V_{GE} = 0$)	650	V
I_C	Continuous collector current at $T_C = 25\text{ °C}$	80 ⁽¹⁾	A
I_C	Continuous collector current at $T_C = 100\text{ °C}$	60	A
I_{CP} ⁽²⁾	Pulsed collector current	240	A
V_{GE}	Gate-emitter voltage	± 20	V
I_F	Continuous forward current at $T_C = 25\text{ °C}$	80 ⁽¹⁾	A
I_F	Continuous forward current at $T_C = 100\text{ °C}$	60	A
P_{TOT}	Total dissipation at $T_C = 25\text{ °C}$	375	W
T_{STG}	Storage temperature range	- 55 to 150	°C
T_J	Operating junction temperature	- 55 to 175	°C

1. Current level is limited by bond wires.
2. Pulse width limited by maximum junction temperature.

Table 3. Thermal data

Symbol	Parameter	Value	Unit
R_{thJC}	Thermal resistance junction-case IGBT	0.4	°C/W
R_{thJC}	Thermal resistance junction-case diode	1.14	°C/W
R_{thJA}	Thermal resistance junction-ambient	50	°C/W

2 Electrical characteristics

$T_J = 25\text{ °C}$ unless otherwise specified.

Table 4. Static characteristics

Symbol	Parameter	Test conditions	Min.	Typ.	Max.	Unit
$V_{(BR)CES}$	Collector-emitter breakdown voltage ($V_{GE} = 0$)	$I_C = 2\text{ mA}$	650			V
$V_{CE(sat)}$	Collector-emitter saturation voltage	$V_{GE} = 15\text{ V}, I_C = 60\text{ A}$		1.60	2	V
		$V_{GE} = 15\text{ V}, I_C = 60\text{ A}$ $T_J = 125\text{ °C}$		1.75		
		$V_{GE} = 15\text{ V}, I_C = 60\text{ A}$ $T_J = 175\text{ °C}$		1.85		
V_F	Forward on-voltage	$I_F = 60\text{ A}$		2	2.6	V
		$I_F = 60\text{ A}, T_J = 125\text{ °C}$		1.7		V
		$I_F = 60\text{ A}, T_J = 175\text{ °C}$		1.6		V
$V_{GE(th)}$	Gate threshold voltage	$V_{CE} = V_{GE}, I_C = 1\text{ mA}$	5	6	7	V
I_{CES}	Collector cut-off current ($V_{GE} = 0$)	$V_{CE} = 650\text{ V}$			25	μA
I_{GES}	Gate-emitter leakage current ($V_{CE} = 0$)	$V_{GE} = \pm 20\text{ V}$			± 250	nA

Table 5. Dynamic characteristics

Symbol	Parameter	Test conditions	Min.	Typ.	Max.	Unit
C_{ies}	Input capacitance	$V_{CE} = 25\text{ V}, f = 1\text{ MHz},$ $V_{GE} = 0$	-	7792	-	pF
C_{oes}	Output capacitance		-	262	-	pF
C_{res}	Reverse transfer capacitance		-	158	-	pF
Q_g	Total gate charge	$V_{CC} = 520\text{ V}, I_C = 60\text{ A},$ $V_{GE} = 15\text{ V},$ see Figure 29	-	306	-	nC
Q_{ge}	Gate-emitter charge		-	126	-	nC
Q_{gc}	Gate-collector charge		-	58	-	nC

Table 6. IGBT switching characteristics (inductive load)

Symbol	Parameter	Test conditions	Min.	Typ.	Max.	Unit	
$t_{d(on)}$	Turn-on delay time	$V_{CE} = 400\text{ V}$, $I_C = 60\text{ A}$, $R_G = 10\ \Omega$, $V_{GE} = 15\text{ V}$, see Figure 28	-	66		ns	
t_r	Current rise time		-	38	-	ns	
$(di/dt)_{on}$	Turn-on current slope		-	1216		A/ μ s	
$t_{d(off)}$	Turn-off delay time				210		ns
t_f	Current fall time		-	20	-	ns	
$E_{on}^{(1)}$	Turn-on switching losses		-	1590	-	μ J	
$E_{off}^{(2)}$	Turn-off switching losses		-	900	-	μ J	
E_{ts}	Total switching losses	-	2490	-	μ J		
$t_{d(on)}$	Turn-on delay time	$V_{CE} = 400\text{ V}$, $I_C = 60\text{ A}$, $R_G = 10\ \Omega$, $V_{GE} = 15\text{ V}$, $T_J = 175\text{ }^\circ\text{C}$, see Figure 28	-	59		ns	
t_r	Current rise time		-	40	-	ns	
$(di/dt)_{on}$	Turn-on current slope		-	1230		A/ μ s	
$t_{d(off)}$	Turn-off delay time				242		ns
t_f	Current fall time		-	147	-	ns	
$E_{on}^{(1)}$	Turn-on switching losses		-	2860	-	μ J	
$E_{off}^{(2)}$	Turn-off switching losses		-	1255	-	μ J	
E_{ts}	Total switching losses	-	4115	-	μ J		

1. Energy losses include reverse recovery of the diode.
2. Turn-off losses include also the tail of the collector current.

Table 7. Diode switching characteristics (inductive load)

Symbol	Parameter	Test conditions	Min.	Typ.	Max.	Unit
t_{rr}	Reverse recovery time	$I_F = 60\text{ A}$, $V_R = 400\text{ V}$, $di/dt = 100\text{ A}/\mu\text{s}$, $V_{GE} = 15\text{ V}$, see Figure 28	-	60	-	ns
Q_{rr}	Reverse recovery charge		-	99	-	nC
I_{rrm}	Reverse recovery current		-	3.3	-	A
dl_{rr}/dt	Peak rate of fall of reverse recovery current during t_b		-	187	-	A/ μ s
E_{rr}	Reverse recovery energy		-	68	-	μ J
t_{rr}	Reverse recovery time	$I_F = 60\text{ A}$, $V_R = 400\text{ V}$, $di/dt = 100\text{ A}/\mu\text{s}$, $V_{GE} = 15\text{ V}$, $T_J = 175\text{ }^\circ\text{C}$, see Figure 28	-	310	-	ns
Q_{rr}	Reverse recovery charge		-	1550	-	nC
I_{rrm}	Reverse recovery current		-	10	-	A
dl_{rr}/dt	Peak rate of fall of reverse recovery current during t_b		-	59	-	A/ μ s
E_{rr}	Reverse recovery energy		-	674	-	μ J

2.1 Electrical characteristics (curves)

Figure 2. Output characteristics ($T_J = 25^\circ\text{C}$)

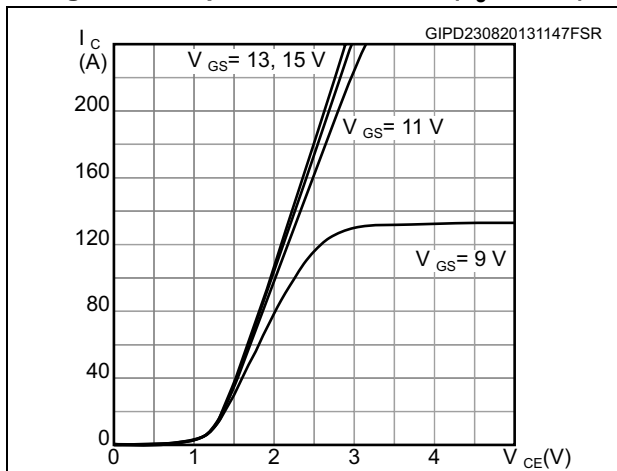

Figure 3. Output characteristics ($T_J = 175^\circ\text{C}$)

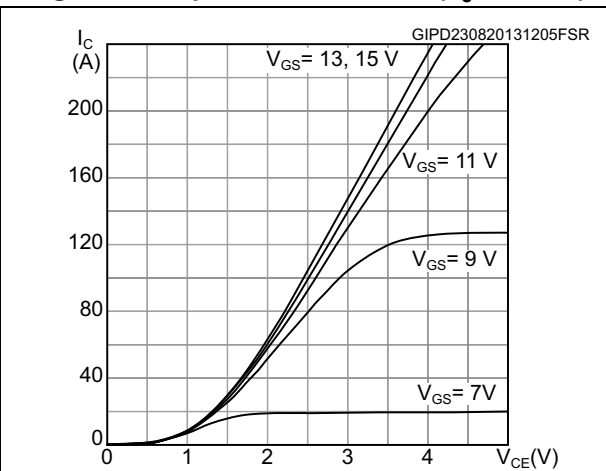

Figure 4. Transfer characteristics

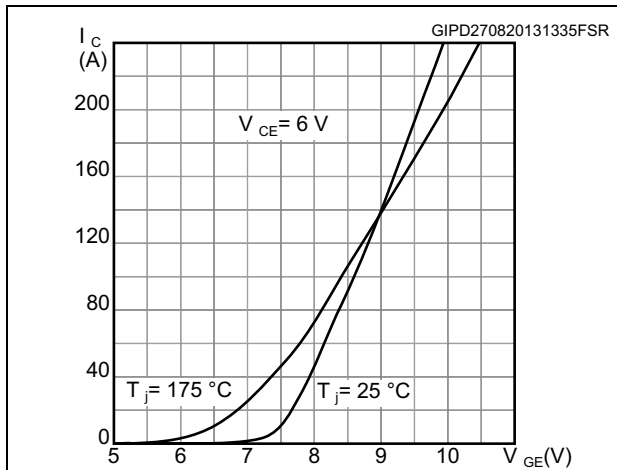

Figure 5. Collector current vs. case temperature

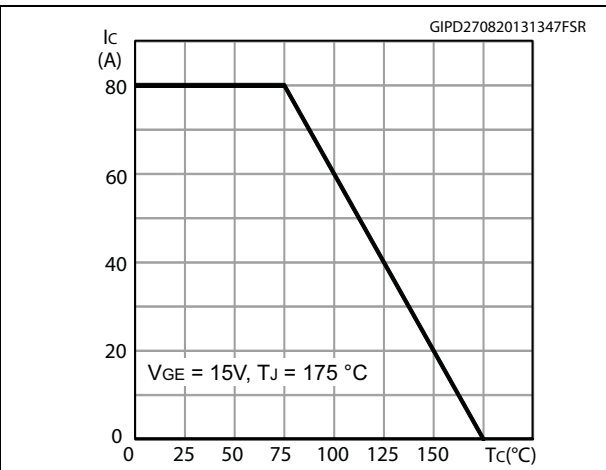

Figure 6. Power dissipation vs. case temperature

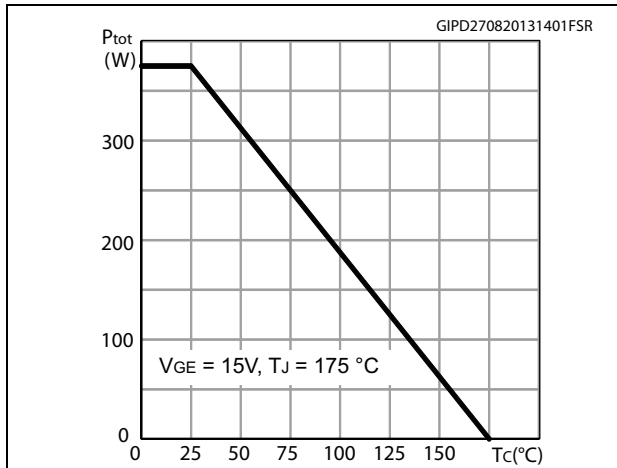

Figure 7. $V_{CE(sat)}$ vs. junction temperature

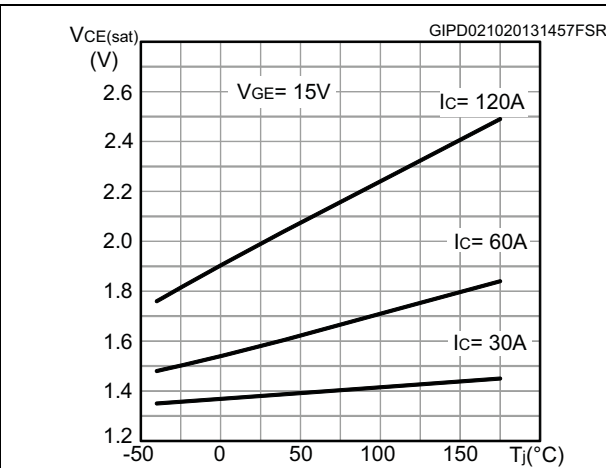

Figure 8. $V_{CE(sat)}$ vs. collector current

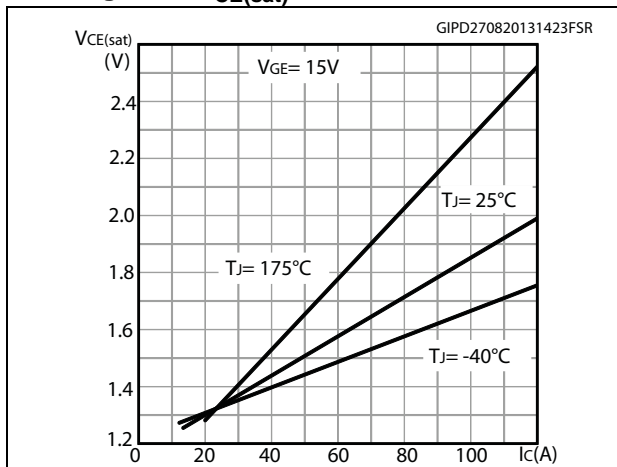

Figure 9. Forward bias safe operating area

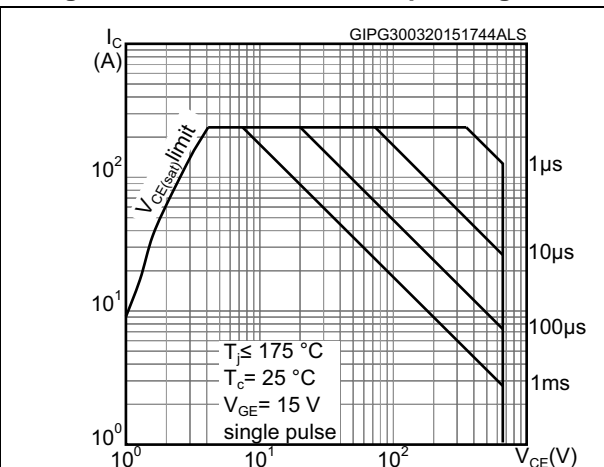

Figure 10. Diode V_F vs. forward current

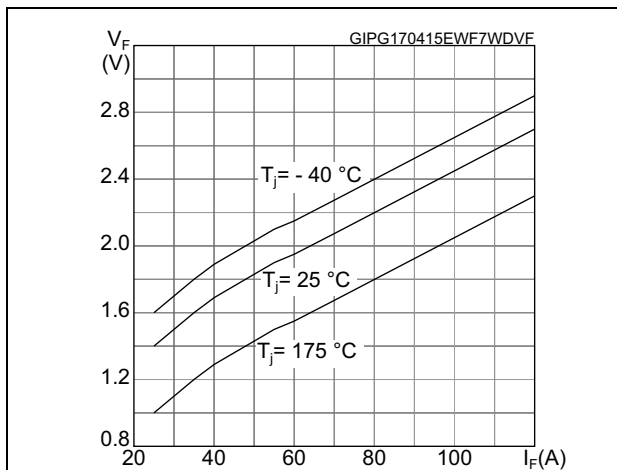

Figure 11. Normalized $V_{(BR)CES}$ vs. junction temperature

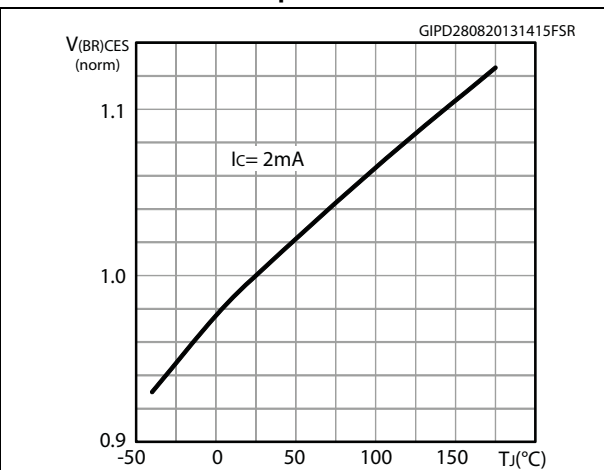

Figure 12. Normalized $V_{GE(th)}$ vs. junction temperature

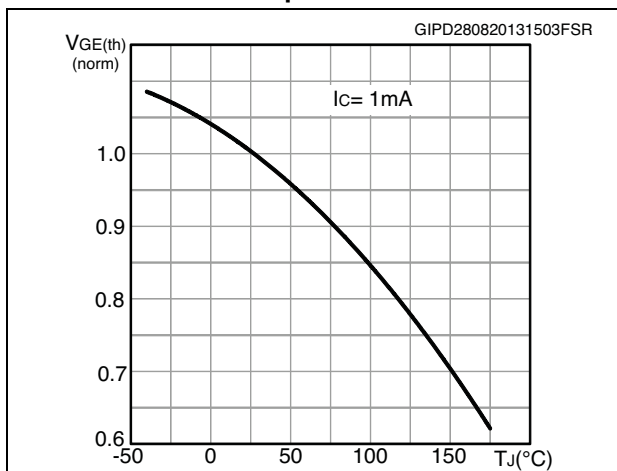

Figure 13. Gate charge vs. gate-emitter voltage

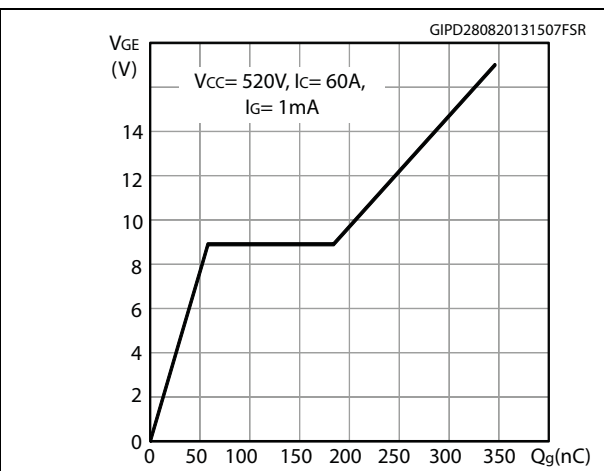

Figure 14. Switching losses vs temperature

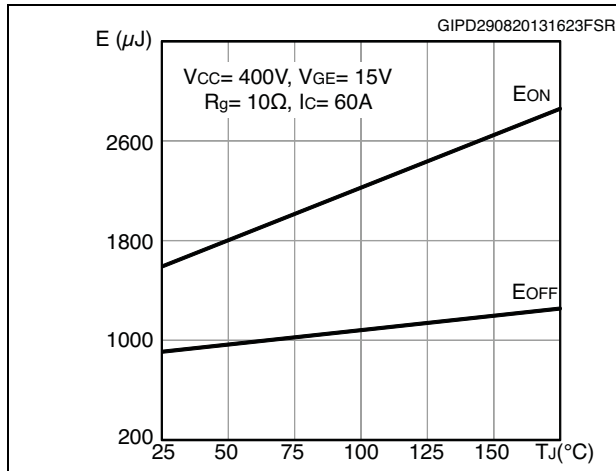

Figure 15. Switching losses vs gate resistance

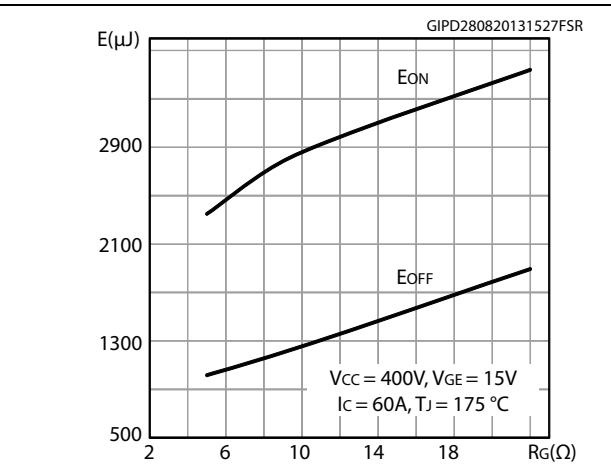

Figure 16. Switching losses vs collector current

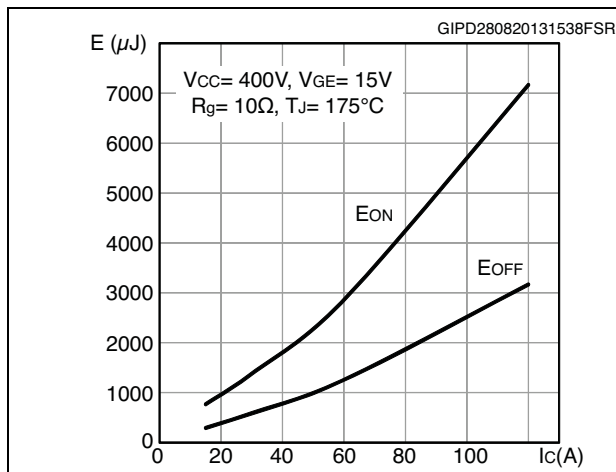

Figure 17. Switching losses vs collector emitter voltage

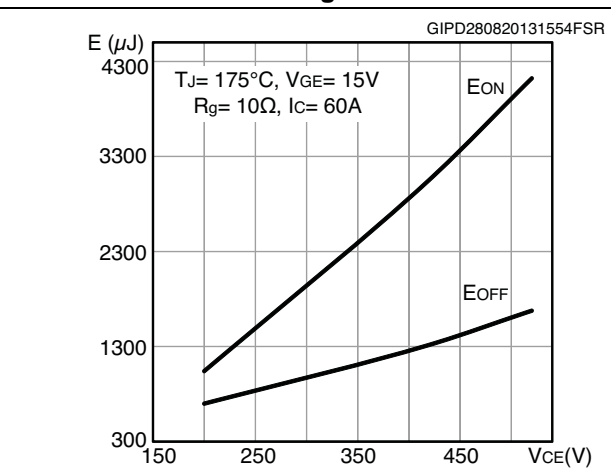

Figure 18. Switching times vs collector current

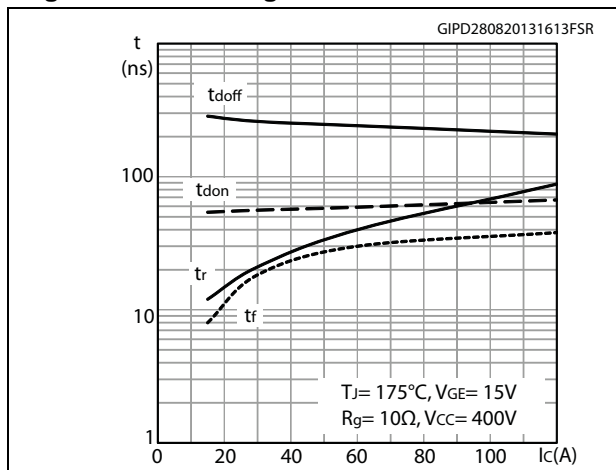

Figure 19. Switching times vs gate resistance

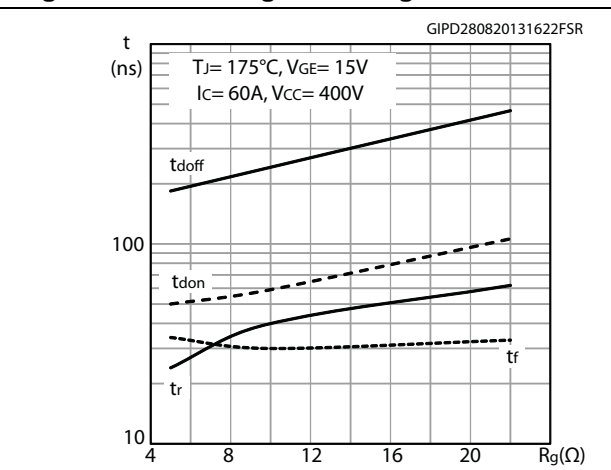

Figure 20. Reverse recovery current vs. diode current slope

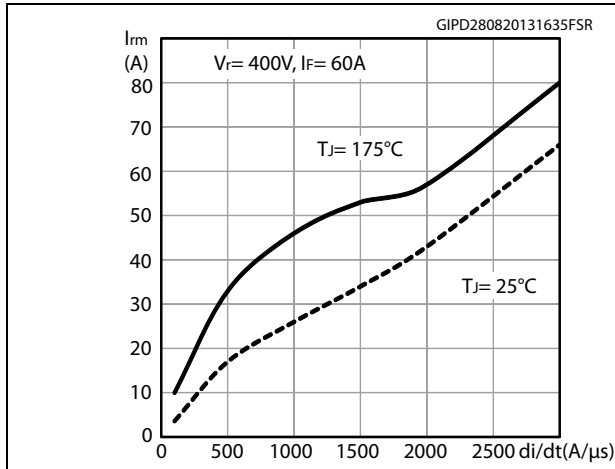

Figure 21. Reverse recovery time vs. diode current slope

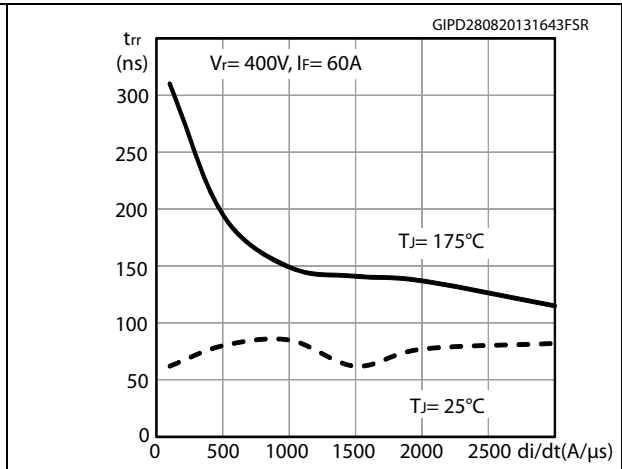

Figure 22. Reverse recovery charge vs. diode current slope

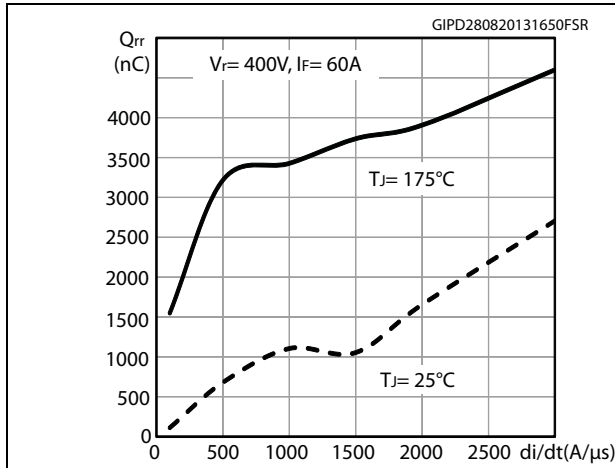

Figure 23. Reverse recovery energy vs. diode current slope

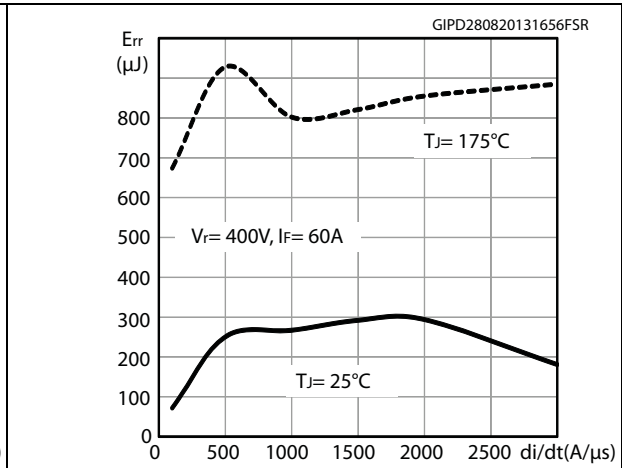

Figure 24. Capacitance variations

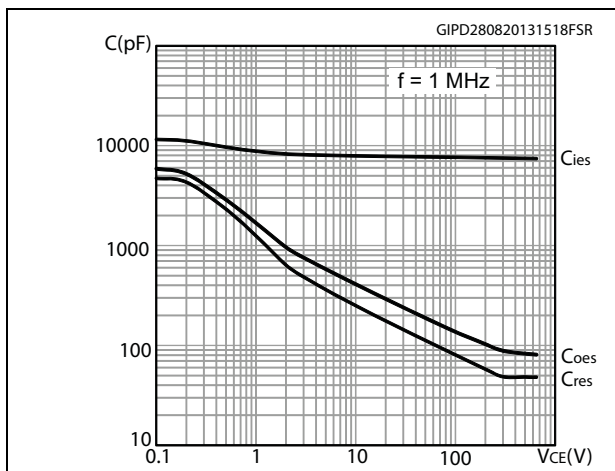

Figure 25. Collector current vs. switching frequency

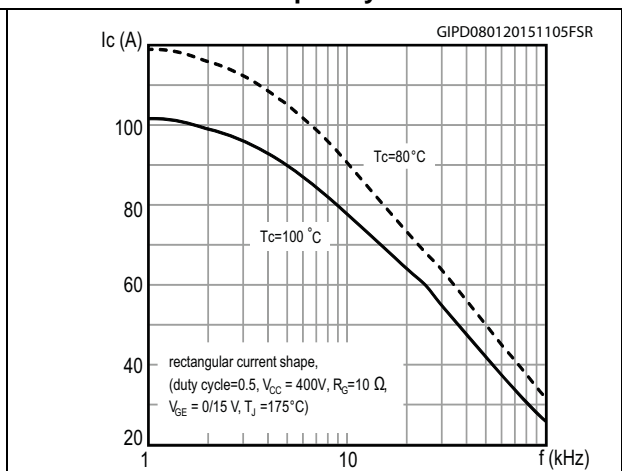

Figure 26. Thermal impedance for IGBT

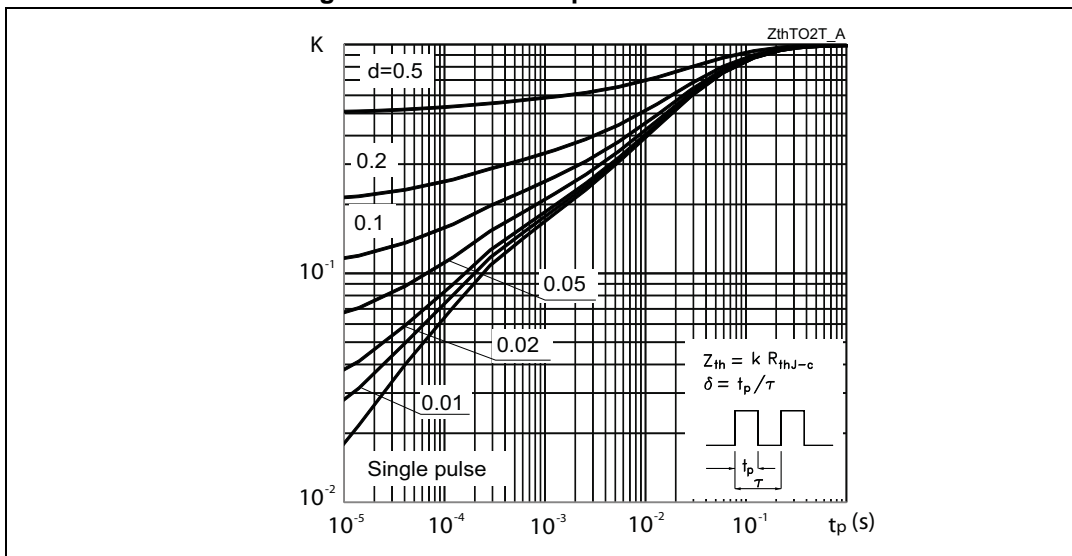
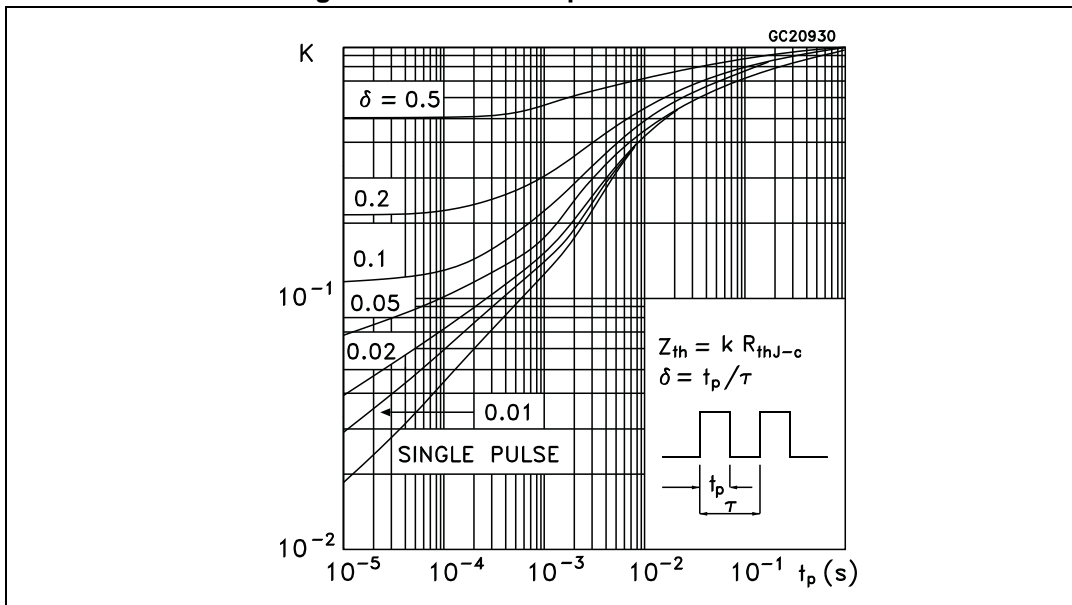
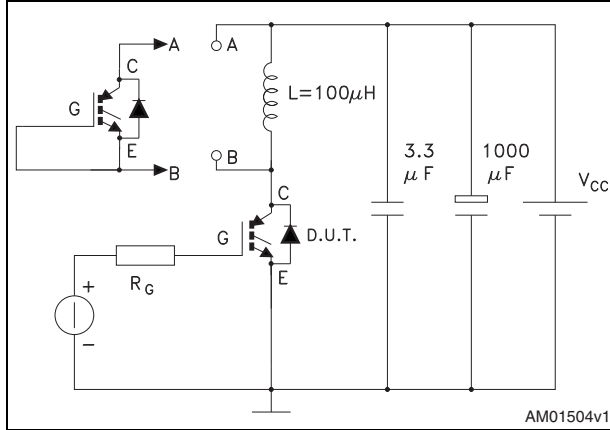

Figure 27. Thermal impedance for diode



3 Test circuits

Figure 28. Test circuit for inductive load switching



AM01504v1

Figure 29. Gate charge test circuit

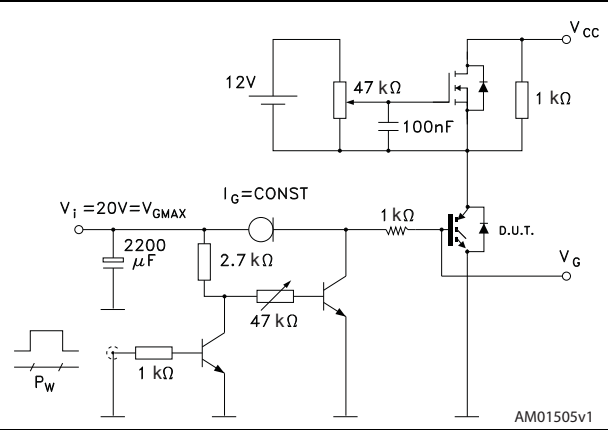

AM01505v1

Figure 30. Switching waveform

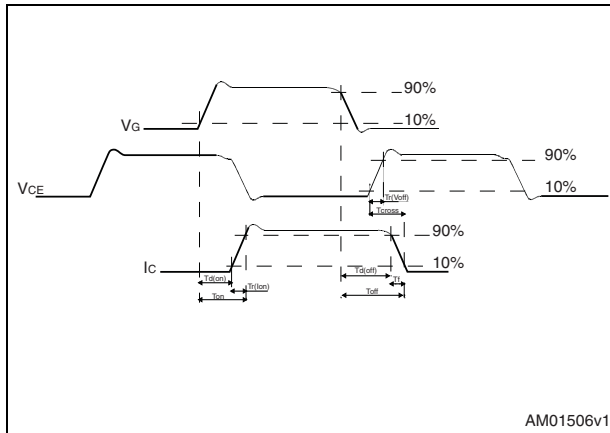

AM01506v1

Figure 31. Diode reverse recovery waveform

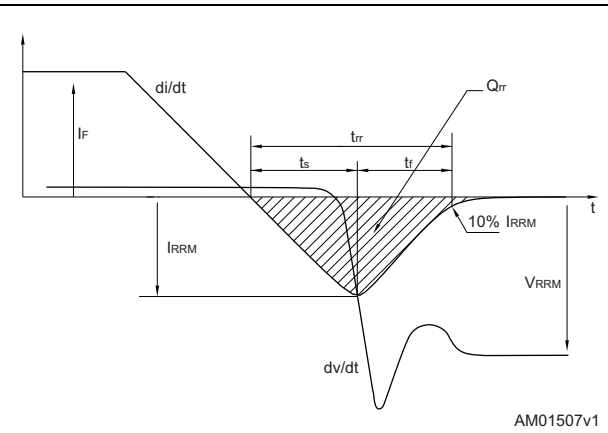

AM01507v1

4 Package information

In order to meet environmental requirements, ST offers these devices in different grades of ECOPACK® packages, depending on their level of environmental compliance. ECOPACK® specifications, grade definitions and product status are available at: www.st.com. ECOPACK is an ST trademark.

4.1 TO-247 package information

Figure 32. TO-247 package outline

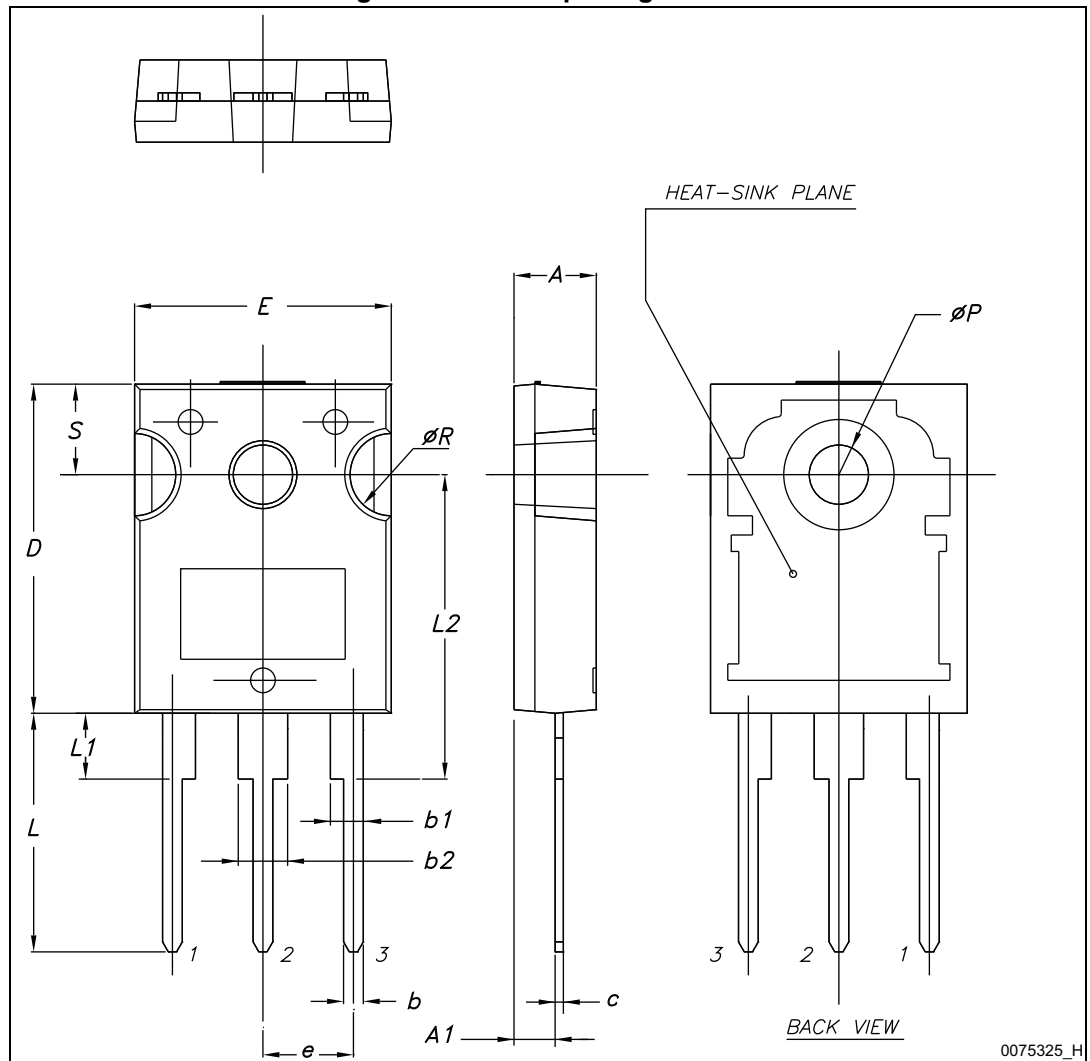

Table 8. TO-247 mechanical data

Dim.	mm.		
	Min.	Typ.	Max.
A	4.85		5.15
A1	2.20		2.60
b	1.0		1.40
b1	2.0		2.40
b2	3.0		3.40
c	0.40		0.80
D	19.85		20.15
E	15.45		15.75
e	5.30	5.45	5.60
L	14.20		14.80
L1	3.70		4.30
L2		18.50	
ØP	3.55		3.65
ØR	4.50		5.50
S	5.30	5.50	5.70

4.2 TO-247 long leads package information

Figure 33. TO-247 long leads package outline

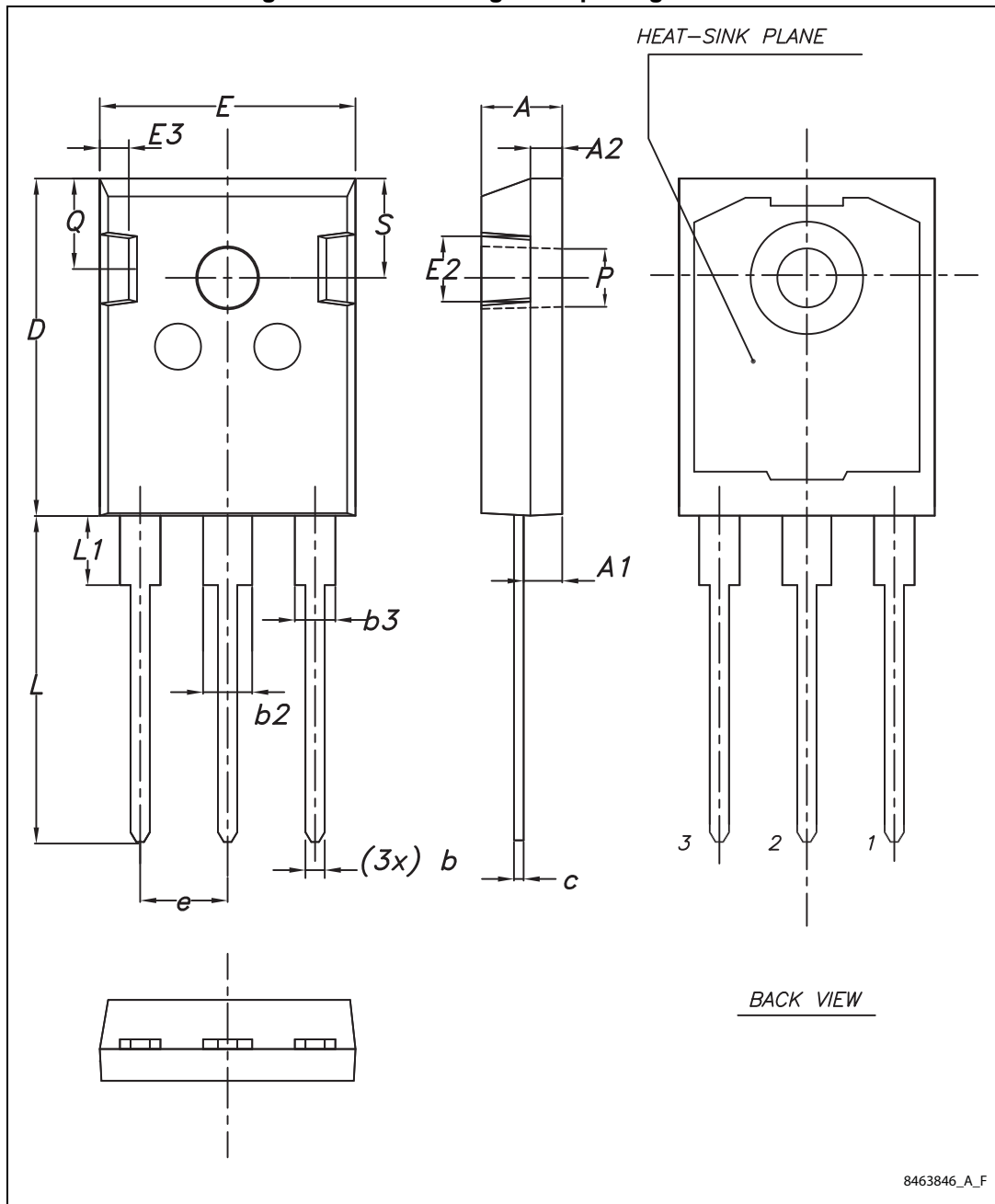

Table 9. TO-247 long leads mechanical data

Dim.	mm		
	Min.	Typ.	Max.
A	4.90	5.00	5.10
A1	2.31	2.41	2.51
A2	1.90	2.00	2.10
b	1.16		1.26
b2			3.25
b3			2.25
c	0.59		0.66
D	20.90	21.00	21.10
E	15.70	15.80	15.90
E2	4.90	5.00	5.10
E3	2.40	2.50	2.60
e	5.34	5.44	5.54
L	19.80	19.92	20.10
L1			4.30
P	3.50	3.60	3.70
Q	5.60		6.00
S	6.05	6.15	6.25

4.3 TO-3P package information

Figure 34. TO-3P package outline

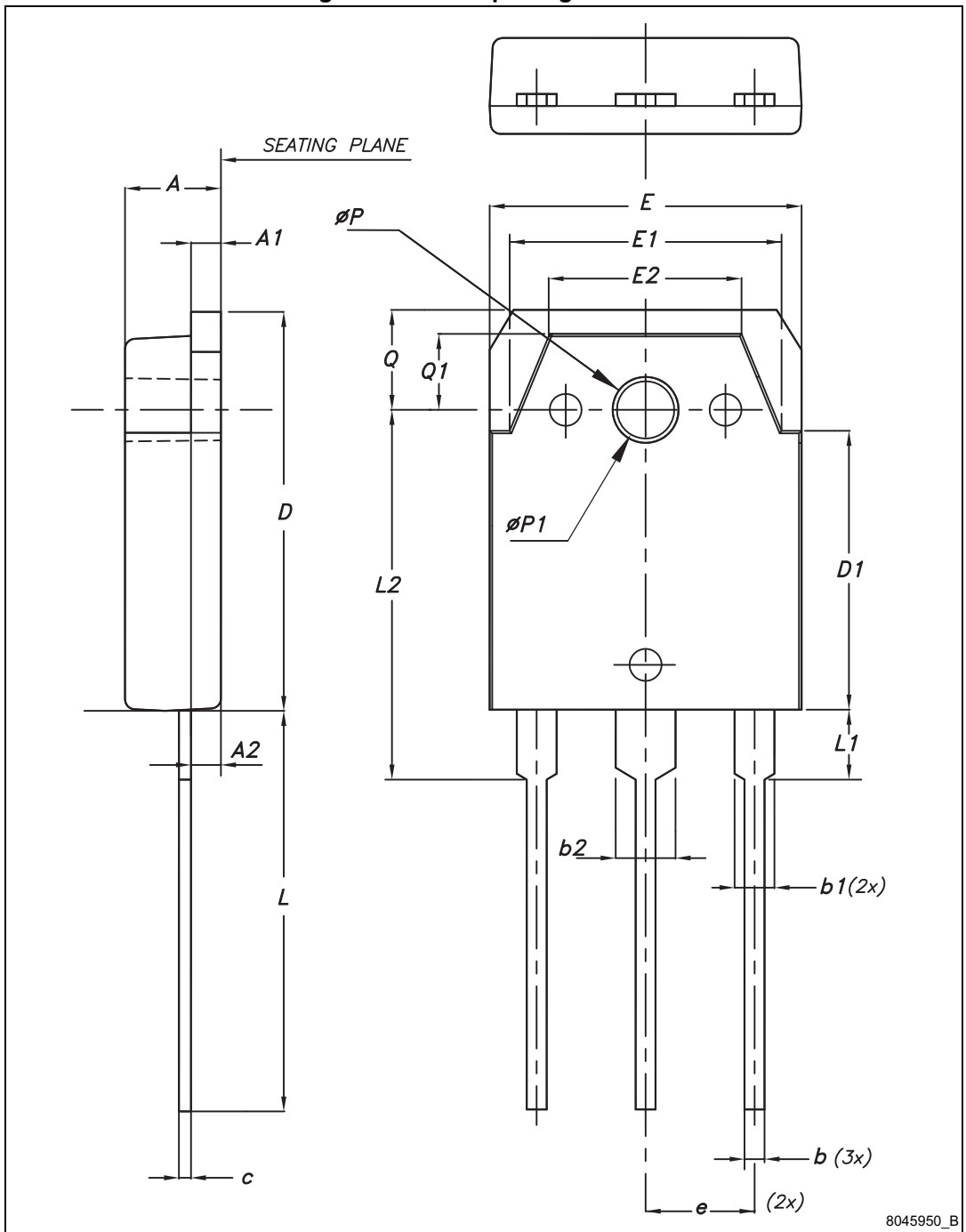

Table 10. TO-3P mechanical data

Dim.	mm		
	Min.	Typ.	Max.
A	4.60	4.80	5
A1	1.45	1.50	1.65
A2	1.20	1.40	1.60
b	0.80	1.00	1.20
b1	1.80	2.00	2.20
b2	2.80	3.00	3.20
c	0.55	0.60	0.75
D	19.70	19.90	20.10
D1	13.70	13.90	14.10
E	15.40	15.60	15.80
E1	13.40	13.60	13.80
E2	9.40	9.60	9.90
e	5.15	5.45	5.75
L	19.80	20	20.20
L1	3.30	3.50	3.70
L2	18.20	18.40	18.60
øP	3.30	3.40	3.50
øP1	3.10	3.20	3.30
Q	4.80	5	5.20
Q1	3.60	3.80	4

5 Revision history

Table 11. Document revision history

Date	Revision	Changes
12-Mar-2013	1	Initial release.
30-Aug-2013	2	Document status promoted from preliminary to production data. Added Section 2.1: Electrical characteristics (curves) .
31-Oct-2013	3	Updated $V_{CE(sat)}$ in Table 4: Static characteristics .
24-Feb-2014	4	Updated title and description in cover page.
09-Jan-2015	5	Updated features in cover page, Table 2: Absolute maximum ratings , and Table 6: IGBT switching characteristics (inductive load) . Updated Figure 5: Collector current vs. case temperature , Figure 6: Power dissipation vs. case temperature , Figure 8: $V_{CE(sat)}$ vs. collector current , Figure 18: Switching times vs collector current , Figure 19: Switching times vs gate resistance and Figure 20: Reverse recovery current vs. diode current slope . Added Figure 25: Collector current vs. switching frequency . Updated Section 4: Package information . Minor text changes.
23-Mar-2015	6	Text edits throughout document. In document, added new order code STGWA60H65DFB in TO-247 long leads package, with accompanying information and data. In Section 2.1: Electrical characteristics (curves) : - updated Figure 2 , Figure 3 , Figure 4 , Figure 7 , Figure 9
17-Apr-2015	7	Text edits throughout document. In Section 2: Electrical characteristics : - updated Table 4: Static characteristics - updated Table 6: IGBT switching characteristics (inductive load) In Section 2.1: Electrical characteristics (curves) : - updated Figure 3 and Figure 9

IMPORTANT NOTICE – PLEASE READ CAREFULLY

STMicroelectronics NV and its subsidiaries ("ST") reserve the right to make changes, corrections, enhancements, modifications, and improvements to ST products and/or to this document at any time without notice. Purchasers should obtain the latest relevant information on ST products before placing orders. ST products are sold pursuant to ST's terms and conditions of sale in place at the time of order acknowledgement.

Purchasers are solely responsible for the choice, selection, and use of ST products and ST assumes no liability for application assistance or the design of Purchasers' products.

No license, express or implied, to any intellectual property right is granted by ST herein.

Resale of ST products with provisions different from the information set forth herein shall void any warranty granted by ST for such product.

ST and the ST logo are trademarks of ST. All other product or service names are the property of their respective owners.

Information in this document supersedes and replaces information previously supplied in any prior versions of this document.

© 2015 STMicroelectronics – All rights reserved



Стандарт Электрон Связь

Мы молодая и активно развивающаяся компания в области поставок электронных компонентов. Мы поставляем электронные компоненты отечественного и импортного производства напрямую от производителей и с крупнейших складов мира.

Благодаря сотрудничеству с мировыми поставщиками мы осуществляем комплексные и плановые поставки широчайшего спектра электронных компонентов.

Собственная эффективная логистика и склад в обеспечивает надежную поставку продукции в точно указанные сроки по всей России.

Мы осуществляем техническую поддержку нашим клиентам и предпродажную проверку качества продукции. На все поставляемые продукты мы предоставляем гарантию .

Осуществляем поставки продукции под контролем ВП МО РФ на предприятия военно-промышленного комплекса России , а также работаем в рамках 275 ФЗ с открытием отдельных счетов в уполномоченном банке. Система менеджмента качества компании соответствует требованиям ГОСТ ISO 9001.

Минимальные сроки поставки, гибкие цены, неограниченный ассортимент и индивидуальный подход к клиентам являются основой для выстраивания долгосрочного и эффективного сотрудничества с предприятиями радиоэлектронной промышленности, предприятиями ВПК и научно-исследовательскими институтами России.

С нами вы становитесь еще успешнее!

Наши контакты:

Телефон: +7 812 627 14 35

Электронная почта: sales@st-electron.ru

Адрес: 198099, Санкт-Петербург,
Промышленная ул, дом № 19, литера Н,
помещение 100-Н Офис 331