

**SMALL SIGNAL COMPLEMENTARY PRE-BIASED DUAL TRANSISTOR**

**Features**

- Epitaxial Planar Die Construction
- Built-In Biasing Resistors
- Surface Mount Package Suited for Automated Assembly
- **Totally Lead-Free & Fully RoHS Compliant (Notes 1 & 2)**
- **Halogen and Antimony Free. "Green" Device (Note 3)**
- **Qualified to AEC-Q101 Standards for High Reliability**
- **PPAP Capable (Note 4)**

**Mechanical Data**

- Case: SOT363
- Case Material: Molded Plastic, "Green" Molding Compound; UL Flammability Classification Rating 94V-0
- Moisture Sensitivity: Level 1 per J-STD-020
- Terminals: Finish – Matte Tin Plated Leads, Solderable per MIL-STD-202, Method 208 (e3)
- Weight: 0.006 grams (Approximate)

<b>R1(NOM)</b>	<b>R2(NOM)</b>
10kΩ	47kΩ

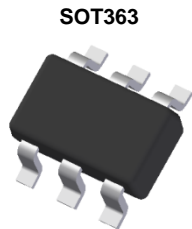

Top View

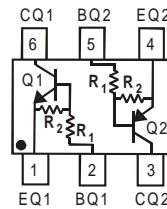

Device Schematic

**Ordering Information** (Notes 4 & 5)

Product	Compliance	Marking	Reel Size (inches)	Tape Width (mm)	Quantity per Reel
ACX114YUQ-7R	Automotive	1Y2	7	8	3,000
ACX114YUQ-13R	Automotive	1Y2	13	8	10,000

- Notes:
1. No purposely added lead. Fully EU Directive 2002/95/EC (RoHS) & 2011/65/EU (RoHS 2) compliant.
  2. See [http://www.diodes.com/quality/lead\\_free.html](http://www.diodes.com/quality/lead_free.html) for more information about Diodes Incorporated's definitions of Halogen- and Antimony-free, "Green" and Lead-free.
  3. Halogen- and Antimony-free "Green" products are defined as those which contain <900ppm bromine, <900ppm chlorine (<1500ppm total Br + Cl) and <1000ppm antimony compounds.
  4. Automotive products are AEC-Q101 qualified and are PPAP capable. Refer to [http://www.diodes.com/quality/product\\_compliance\\_definitions/](http://www.diodes.com/quality/product_compliance_definitions/).
  5. -13R are parts rotated in the pocket tape by +180°. For packaging details, go to our website at <http://www.diodes.com/products/packages.html>.

**Marking Information**

SOT363

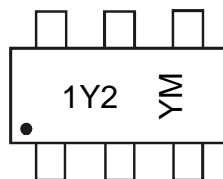

1Y2 = Product Type Marking Code  
 YM = Date Code Marking  
 Y = Year (ex: D = 2016)  
 M = Month (ex: 9 = September)

Date Code Key

Year	2016	2017	2018	2019	2020	2021	2022	2023	2024	2025	2026	
Code	D	E	F	G	H	I	J	K	L	M	N	
Month	Jan	Feb	Mar	Apr	May	Jun	Jul	Aug	Sep	Oct	Nov	Dec
Code	1	2	3	4	5	6	7	8	9	O	N	D

---

**Absolute Maximum Ratings - NPN Section** (@ $T_A = +25^\circ\text{C}$ , unless otherwise specified.)
 

---

Characteristic	Symbol	Value	Unit
Supply Voltage <Pin: (6) to (1)>	$V_{CC}$	50	V
Input Voltage <Pin: (2) to (1)>	$V_{IN}$	-6 to +40	V
Output Current	$I_O$	70	mA
Output Current	$I_C$ (Max)	100	mA

---

**Absolute Maximum Ratings - PNP Section** (@ $T_A = +25^\circ\text{C}$ , unless otherwise specified.)
 

---

Characteristic	Symbol	Value	Unit
Supply Voltage <Pin: (4) to (3)>	$V_{CC}$	-50	V
Input Voltage <Pin: (5) to (4)>	$V_{IN}$	+6 to -40	V
Output Current	$I_O$	-70	mA
Output Current	$I_C$ (Max)	-100	mA

---

**Thermal Characteristics** (@ $T_A = +25^\circ\text{C}$ , unless otherwise specified.)
 

---

Characteristic	Symbol	Value	Unit
Power Dissipation (Notes 6 & 7)	$P_D$	270	mW
Thermal Resistance, Junction to Ambient Air (Note 6)	$R_{\theta JA}$	450	$^\circ\text{C}/\text{W}$
Operating and Storage Temperature Range	$T_J, T_{STG}$	-55 to +150	$^\circ\text{C}$

Notes: 6. Mounted on FR4 PC Board with minimum recommended pad layout.  
 7. 150mW per element must not be exceeded.

**Thermal Characteristics and Derating Information**

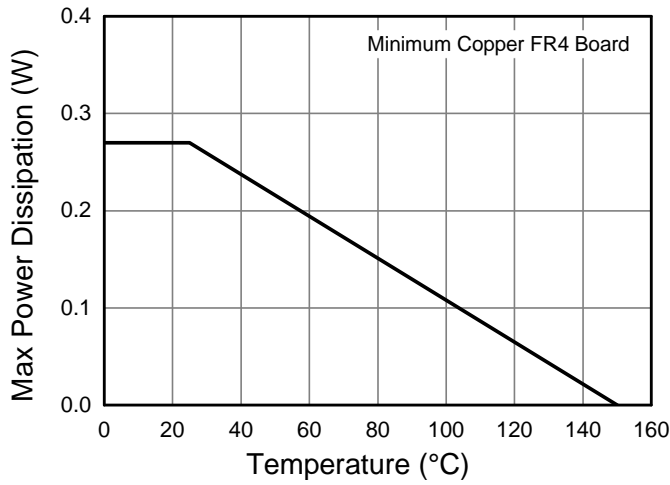

**Derating Curve**

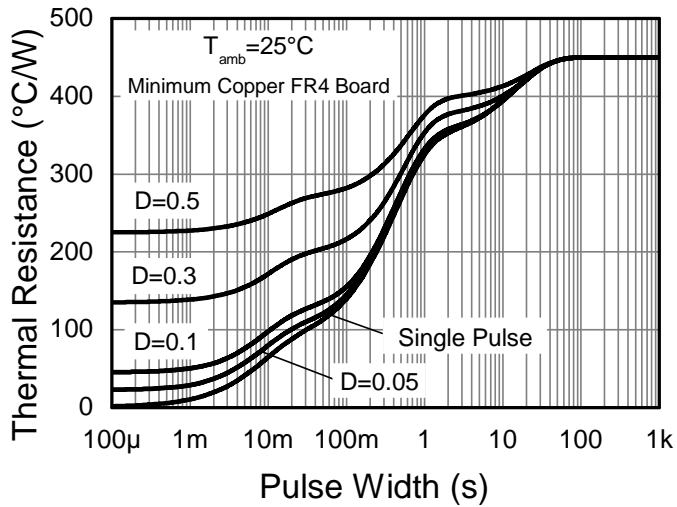

**Transient Thermal Impedance**

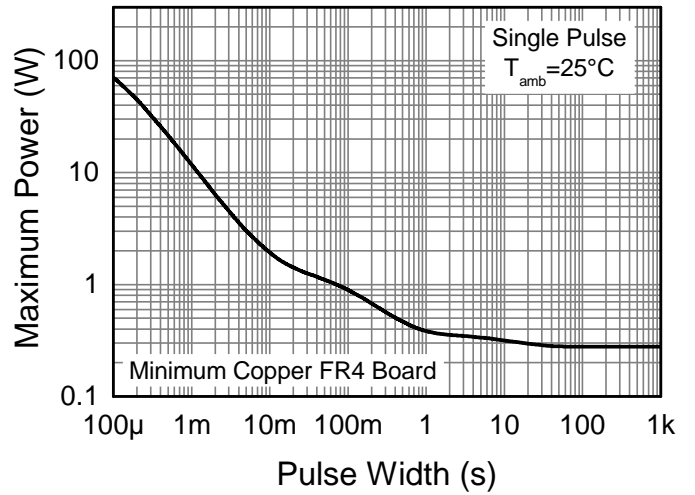

**Pulse Power Dissipation**

**Electrical Characteristics - NPN Section** (@ $T_A = +25^\circ\text{C}$ , unless otherwise specified.)

Characteristic	Symbol	Min	Typ	Max	Unit	Test Condition
Input Voltage	$V_{I(OFF)}$	0.3	—	—	V	$V_{CC} = 5V, I_O = 100\mu\text{A}$
	$V_{I(ON)}$	—	—	1.4		$V_O = 0.3V, I_O = 1\text{mA}$
Output Voltage	$V_{O(ON)}$	—	0.1	0.3	V	$I_O/I_I = 5\text{mA} / 0.25\text{mA}$
Input Current	$I_I$	—	—	0.88	mA	$V_I = 5V$
Output Current	$I_{O(OFF)}$	—	—	0.5	$\mu\text{A}$	$V_{CC} = 50V, V_I = 0V$
DC Current Gain (Note 8)	$G_I$	80	—	—	—	$V_O = 5V, I_O = 10\text{mA}$
Input Resistor ( $R_1$ ) Tolerance	$\Delta R_1$	-30	—	+30	%	—
Resistance Ratio Tolerance	$\Delta R_2/R_1$	-20	—	+20	%	—
Gain-Bandwidth Product	$f_T$	—	250	—	MHz	$V_{CE} = 10V, I_E = 5\text{mA}, f = 100\text{MHz}$

**Electrical Characteristics - PNP Section** (@ $T_A = +25^\circ\text{C}$ , unless otherwise specified.)

Characteristic	Symbol	Min	Typ	Max	Unit	Test Condition
Input Voltage	$V_{I(OFF)}$	-0.3	—	—	V	$V_{CC} = -5V, I_O = -100\mu\text{A}$
	$V_{I(ON)}$	—	—	-1.4		$V_O = -0.3V, I_O = -1\text{mA}$
Output Voltage	$V_{O(ON)}$	—	-0.1	-0.3	V	$I_O/I_I = -5\text{mA} / -0.25\text{mA}$
Input Current	$I_I$	—	—	-0.88	mA	$V_I = -5V$
Output Current	$I_{O(OFF)}$	—	—	-0.5	$\mu\text{A}$	$V_{CC} = -50V, V_I = 0V$
DC Current Gain (Note 8)	$G_I$	80	—	—	—	$V_O = -5V, I_O = -10\text{mA}$
Input Resistor ( $R_1$ ) Tolerance	$\Delta R_1$	-30	—	+30	%	—
Resistance Ratio Tolerance	$\Delta R_2/R_1$	-20	—	+20	%	—
Gain-Bandwidth Product	$f_T$	—	250	—	MHz	$V_{CE} = -10V, I_E = -5\text{mA}, f = 100\text{MHz}$

Note: 8. Measured under pulsed conditions. Pulse width  $\leq 300\mu\text{s}$ . Duty cycle  $\leq 2\%$ .

**Typical Electrical Characteristics – NPN Section** (@T<sub>A</sub> = +25°C, unless otherwise specified.)

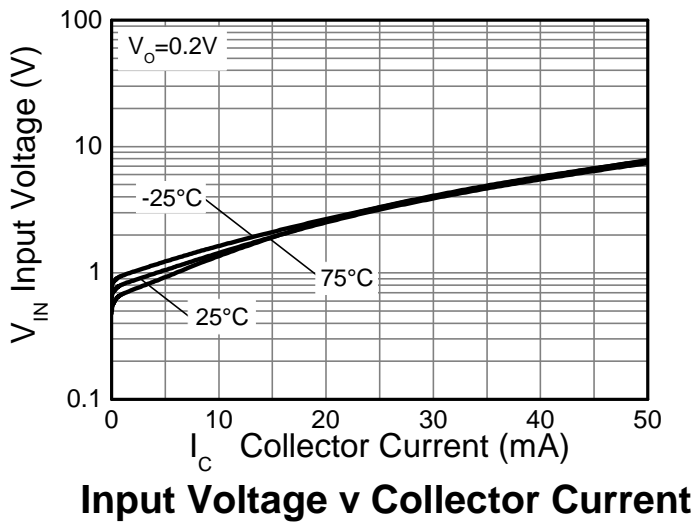
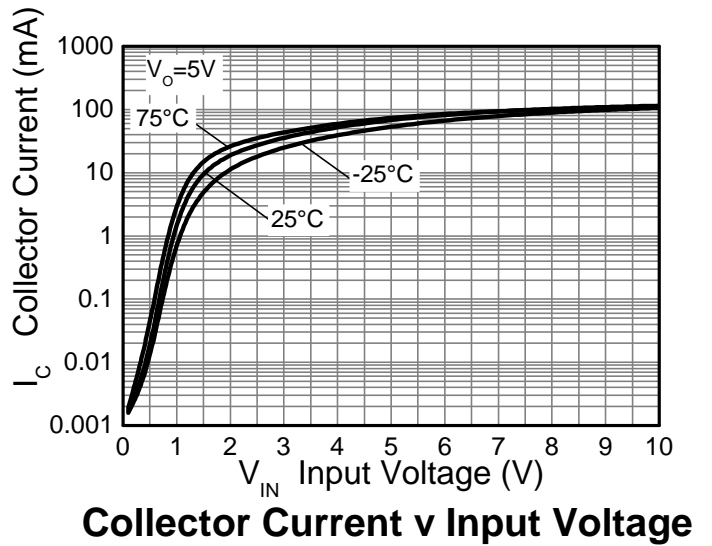
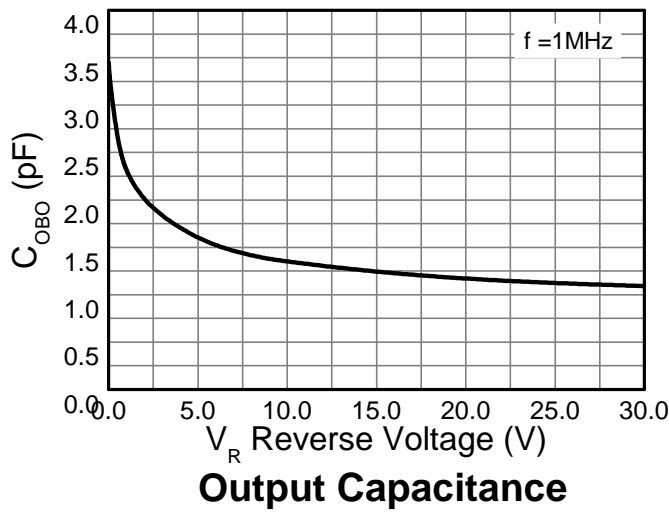
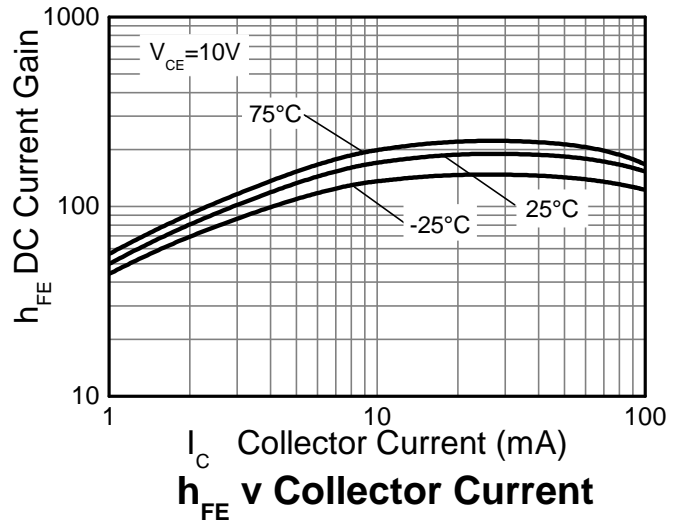
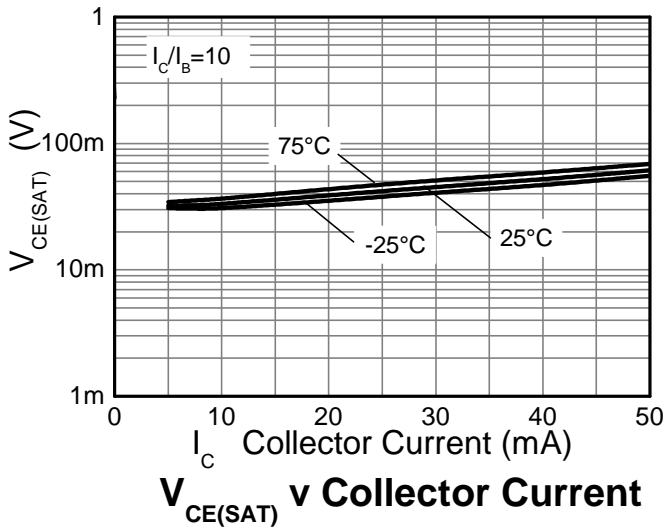

**Typical Electrical Characteristics – PNP Section** (@T<sub>A</sub> = +25°C, unless otherwise specified.)

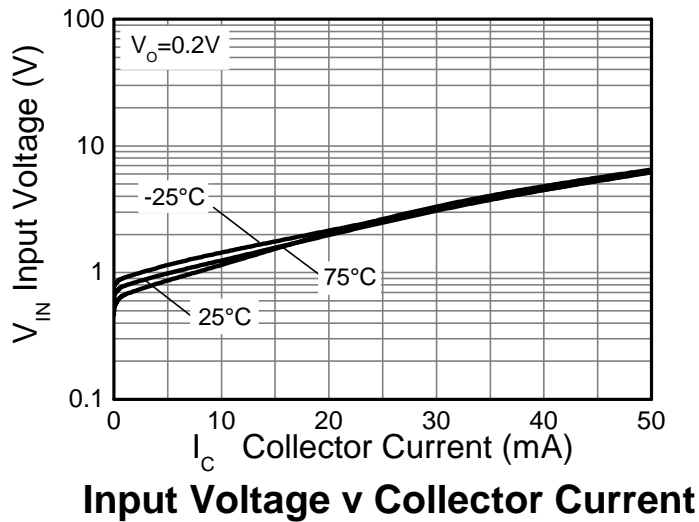
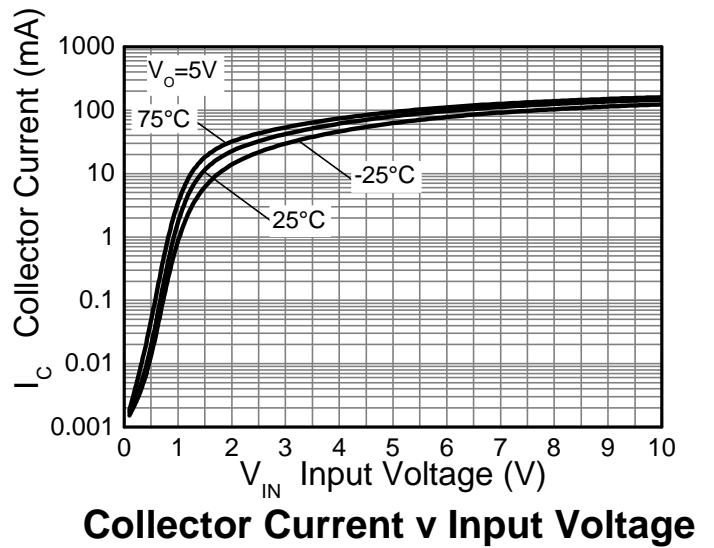
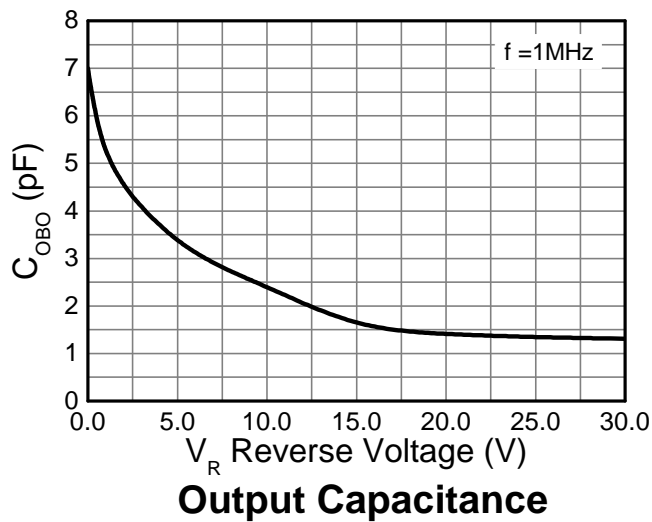
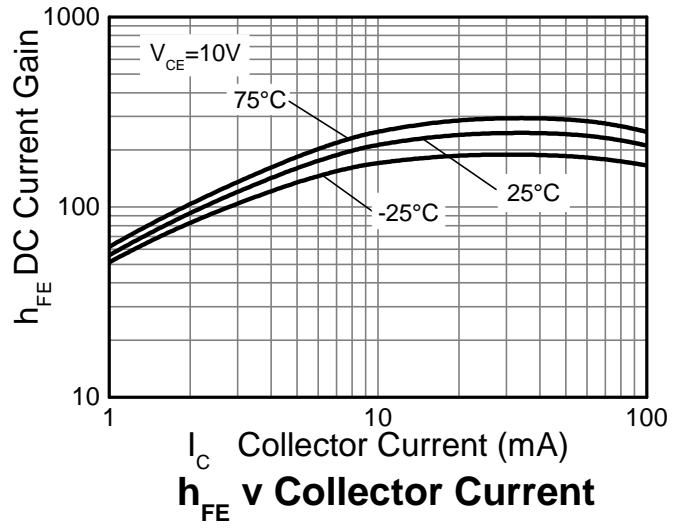
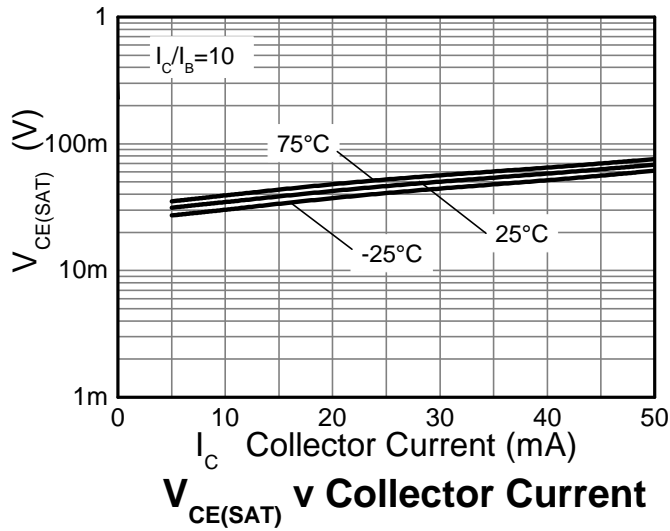

**Package Outline Dimensions**

Please see <http://www.diodes.com/package-outlines.html> for the latest version.

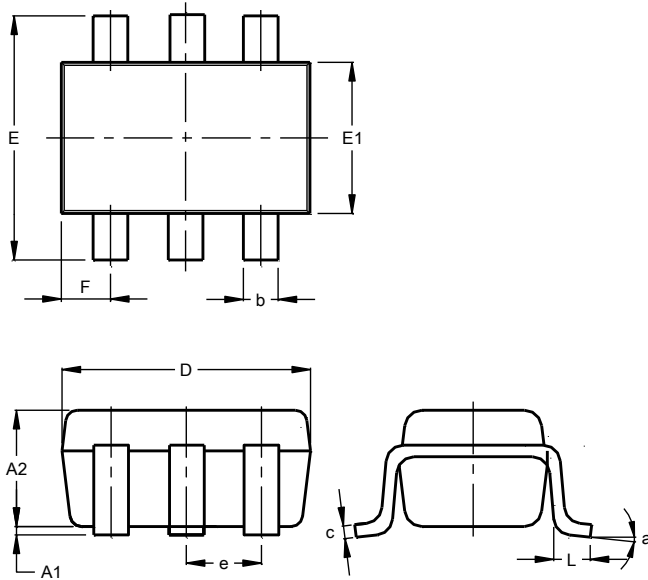

SOT363			
Dim	Min	Max	Typ
A1	0.00	0.10	0.05
A2	0.90	1.00	1.00
b	0.10	0.30	0.25
c	0.10	0.22	0.11
D	1.80	2.20	2.15
E	2.00	2.20	2.10
E1	1.15	1.35	1.30
e	0.650 BSC		
F	0.40	0.45	0.425
L	0.25	0.40	0.30
a	0°	8°	--
<b>All Dimensions in mm</b>			

**Suggested Pad Layout**

Please see <http://www.diodes.com/package-outlines.html> for the latest version.

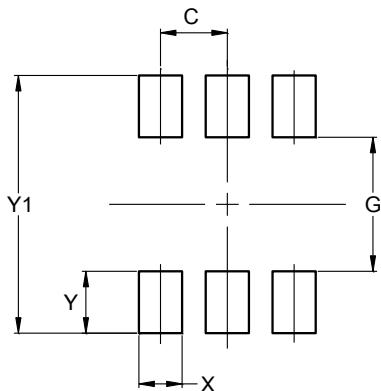

Dimensions	Value (in mm)
C	0.650
G	1.300
X	0.420
Y	0.600
Y1	2.500

**IMPORTANT NOTICE**

DIODES INCORPORATED MAKES NO WARRANTY OF ANY KIND, EXPRESS OR IMPLIED, WITH REGARDS TO THIS DOCUMENT, INCLUDING, BUT NOT LIMITED TO, THE IMPLIED WARRANTIES OF MERCHANTABILITY AND FITNESS FOR A PARTICULAR PURPOSE (AND THEIR EQUIVALENTS UNDER THE LAWS OF ANY JURISDICTION).

Diodes Incorporated and its subsidiaries reserve the right to make modifications, enhancements, improvements, corrections or other changes without further notice to this document and any product described herein. Diodes Incorporated does not assume any liability arising out of the application or use of this document or any product described herein; neither does Diodes Incorporated convey any license under its patent or trademark rights, nor the rights of others. Any Customer or user of this document or products described herein in such applications shall assume all risks of such use and will agree to hold Diodes Incorporated and all the companies whose products are represented on Diodes Incorporated website, harmless against all damages.

Diodes Incorporated does not warrant or accept any liability whatsoever in respect of any products purchased through unauthorized sales channel. Should Customers purchase or use Diodes Incorporated products for any unintended or unauthorized application, Customers shall indemnify and hold Diodes Incorporated and its representatives harmless against all claims, damages, expenses, and attorney fees arising out of, directly or indirectly, any claim of personal injury or death associated with such unintended or unauthorized application.

Products described herein may be covered by one or more United States, international or foreign patents pending. Product names and markings noted herein may also be covered by one or more United States, international or foreign trademarks.

This document is written in English but may be translated into multiple languages for reference. Only the English version of this document is the final and determinative format released by Diodes Incorporated.

**LIFE SUPPORT**

Diodes Incorporated products are specifically not authorized for use as critical components in life support devices or systems without the express written approval of the Chief Executive Officer of Diodes Incorporated. As used herein:

A. Life support devices or systems are devices or systems which:

1. are intended to implant into the body, or
2. support or sustain life and whose failure to perform when properly used in accordance with instructions for use provided in the labeling can be reasonably expected to result in significant injury to the user.

B. A critical component is any component in a life support device or system whose failure to perform can be reasonably expected to cause the failure of the life support device or to affect its safety or effectiveness.

Customers represent that they have all necessary expertise in the safety and regulatory ramifications of their life support devices or systems, and acknowledge and agree that they are solely responsible for all legal, regulatory and safety-related requirements concerning their products and any use of Diodes Incorporated products in such safety-critical, life support devices or systems, notwithstanding any devices- or systems-related information or support that may be provided by Diodes Incorporated. Further, Customers must fully indemnify Diodes Incorporated and its representatives against any damages arising out of the use of Diodes Incorporated products in such safety-critical, life support devices or systems.

Copyright © 2016, Diodes Incorporated

[www.diodes.com](http://www.diodes.com)





## Стандарт Электрон Связь

Мы молодая и активно развивающаяся компания в области поставок электронных компонентов. Мы поставляем электронные компоненты отечественного и импортного производства напрямую от производителей и с крупнейших складов мира.

Благодаря сотрудничеству с мировыми поставщиками мы осуществляем комплексные и плановые поставки широчайшего спектра электронных компонентов.

Собственная эффективная логистика и склад в обеспечивает надежную поставку продукции в точно указанные сроки по всей России.

Мы осуществляем техническую поддержку нашим клиентам и предпродажную проверку качества продукции. На все поставляемые продукты мы предоставляем гарантию .

Осуществляем поставки продукции под контролем ВП МО РФ на предприятия военно-промышленного комплекса России , а также работаем в рамках 275 ФЗ с открытием отдельных счетов в уполномоченном банке. Система менеджмента качества компании соответствует требованиям ГОСТ ISO 9001.

Минимальные сроки поставки, гибкие цены, неограниченный ассортимент и индивидуальный подход к клиентам являются основой для выстраивания долгосрочного и эффективного сотрудничества с предприятиями радиоэлектронной промышленности, предприятиями ВПК и научно-исследовательскими институтами России.

С нами вы становитесь еще успешнее!

### Наши контакты:

**Телефон:** +7 812 627 14 35

**Электронная почта:** [sales@st-electron.ru](mailto:sales@st-electron.ru)

**Адрес:** 198099, Санкт-Петербург,  
Промышленная ул, дом № 19, литера Н,  
помещение 100-Н Офис 331