

# HLMP-3351, HLMP-3366, HLMP-3451, HLMP-3466, HLMP-3554, HLMP-3568

T-1<sup>3</sup>/<sub>4</sub> (5 mm) Low Profile LED Lamps



## Data Sheet



### Description

The HLMP-335x/-336x Series are Gallium Arsenide Phosphide on Gallium Phosphide High Efficiency Red Light Emitting Diodes.

The HLMP-345x/-346x Series are Gallium Arsenide Phosphide on Gallium Phosphide Yellow Light Emitting Diodes.

The HLMP-355x/-356x Series are Gallium Phosphide Green Light Emitting Diodes.

The Low Profile T-1<sup>3</sup>/<sub>4</sub> package provides space savings and is excellent for backlighting applications.

### Features

- High intensity
- Low profile: 5.8 mm (0.23 in.) nominal
- T-1<sup>3</sup>/<sub>4</sub> diameter package
- Diffused and non-diffused types
- General purpose leads
- IC compatible/low current requirements
- Reliable and rugged

### Package Dimensions

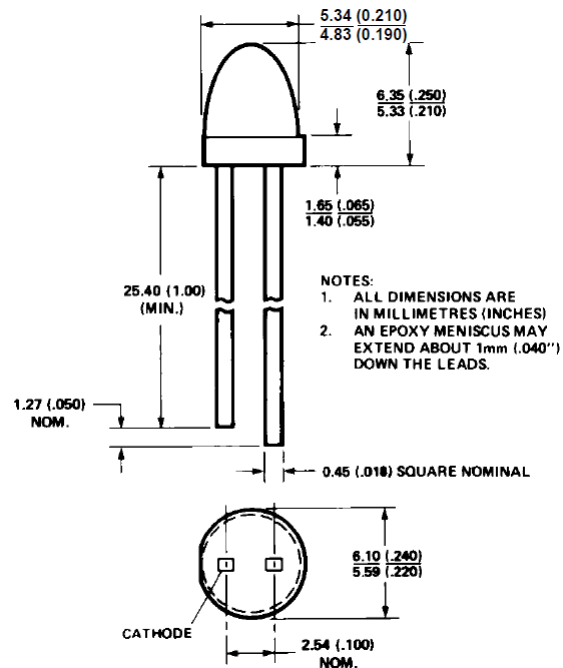

## Selection Guide

Color	Package Description	2θ <sup>1/2</sup> [1]	Part Number HLMP-	Luminous Intensity I <sub>v</sub> (mcd)	
				Min.	Max.
Red	T-1 <sup>3/4</sup> Tinted, diffused	50	3351	5.4	-
			3351-D00xx	2.1	-
			3351-F00xx	5.4	-
	T-1 <sup>3/4</sup> Tinted, non-diffused	45	3366	13.8	-
			3366-H00xx	13.8	-
Yellow	T-1 <sup>3/4</sup> Tinted, diffused	50	3451	3.6	-
			3451-D00xx	3.6	-
			3451-EFBxx	5.7	18.4
			3451-F00xx	9.2	-
	T-1 <sup>3/4</sup> Tinted, non-diffused	45	3466	9.2	-
			3466-F00xx	9.2	-
Green	T-1 <sup>3/4</sup> Tinted, diffused	50	3554	6.7	-
			3554-E00xx	6.7	-
	T-1 <sup>3/4</sup> Tinted, non-diffused	40	3568	10.6	-
			3568-F00xx	10.6	-

## Part Numbering System

HLMP - 3 x xx - x x x xx

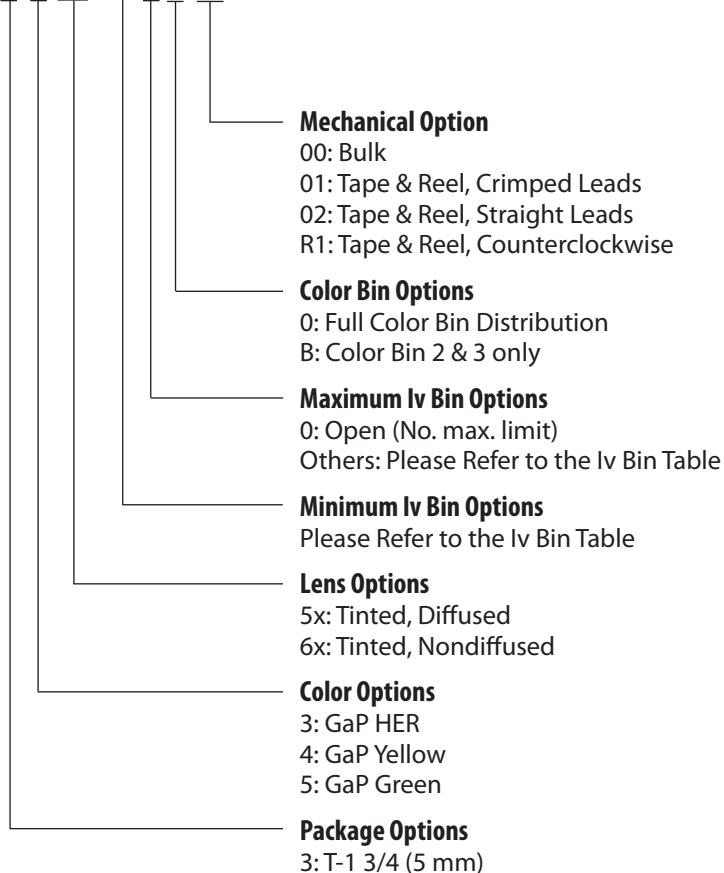

### Absolute Maximum Ratings at $T_A = 25^\circ\text{C}$

Parameter	3350 Series	3450 Series	3550 Series	Units
Peak Forward Current	90	60	90	mA
Average Forward Current <sup>[1]</sup>	25	20	25	mA
DC Current <sup>[2]</sup>	30	20	30	mA
Power Dissipation <sup>[3]</sup>	135	85	135	mW
Reverse Voltage ( $I_R = 100 \mu\text{A}$ )	5	5	5	V
Transient Forward Current <sup>[4]</sup> (10 $\mu\text{s}$ Pulse)	500	500	500	mA
Operating Temperature Range	-40 to +100	-40 to +100	-20 to +100	$^\circ\text{C}$
Storage Temperature Range	-40 to +100	-40 to +100	-40 to +100	
Wave Soldering Temperature [1.59 mm (0.063 in.) from Body]	250 $^\circ\text{C}$ for 3 seconds			
Solder Dipping Temperature [1.59 mm (0.063 in.) from Body]	260 $^\circ\text{C}$ for 5 seconds			

Notes:

1. See Figure 10 (High Efficiency Red), 15 (Yellow), or 20 (Green) to establish pulsed operating conditions.
2. For High Efficiency Red and Green Series, derate linearly from 50 $^\circ\text{C}$  at 0.5 mA/ $^\circ\text{C}$ . For Red and Yellow Series, derate linearly from 50 $^\circ\text{C}$  at 0.2 mA/ $^\circ\text{C}$ .
3. For High Efficiency Red and Green Series, derate power linearly from 25 $^\circ\text{C}$  at 1.8 mW/ $^\circ\text{C}$ . For Red and Yellow Series, derate power linearly from 50 $^\circ\text{C}$  at 1.6 mW/ $^\circ\text{C}$ .
4. The transient peak current is the maximum non-recurring peak current that can be applied to the device without damaging the LED die and wirebond. It is not recommended that the device be operated at peak current beyond the peak forward current listed in the Absolute Maximum Ratings.

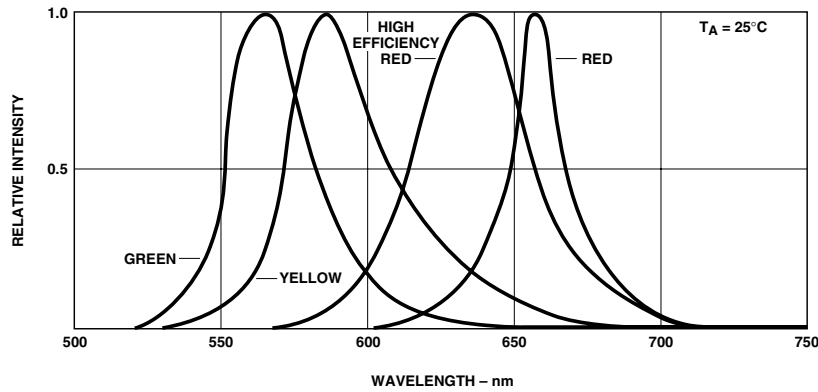

Figure 1. Relative intensity vs. wavelength.

## High Efficiency Red HLMP-335x/-336x Series Electrical Specifications at $T_A = 25^\circ\text{C}$

Symbol	Description	Device HLMP-	Min.	Typ.	Max.	Units	Test Conditions
$2\theta_{1/2}$	Including Angle Between Half Luminous Intensity Points	3366		50 50 45 45		Deg.	Note 1 (Figure 11)
$\lambda_{\text{PEAK}}$	Peak Wavelength			635		nm	Measurement at Peak (Figure 1)
$\lambda_d$	Dominant Wavelength			626		nm	Note 2
$\Delta\lambda_{1/2}$	Spectral Line Halfwidth			40		nm	
$\tau_s$	Speed of Response			90		ns	
C	Capacitance			11		pF	$V_F = 0$ ; $f = 1$ MHz
$R\theta_{\text{J-PIN}}$	Thermal Resistance			260		$^\circ\text{C/W}$	Junction to Cathode Lead
$V_F$	Forward Voltage			1.9	2.4	V	$I_F = 10$ mA (Figure 7)
$V_R$	Reverse Breakdown Voltage		5.0			V	$I_R = 100$ $\mu\text{A}$
$\eta_V$	Luminous Efficacy			145		lm/W	Note 3

### Notes:

- $\theta_{1/2}$  is the off-axis angle at which the luminous intensity is half the axial luminous intensity.
- Dominant wavelength,  $\lambda_d$ , is derived from the CIE chromaticity diagram and represents the single wavelength which defines the color of the device.
- Radiant Intensity,  $I_e$ , in watts/steradian may be found from the equation  $I_e = I_v/\eta_v$ , where  $I_v$  is the luminous intensity in candelas and  $\eta_v$  is the luminous efficacy in lumens/watt.

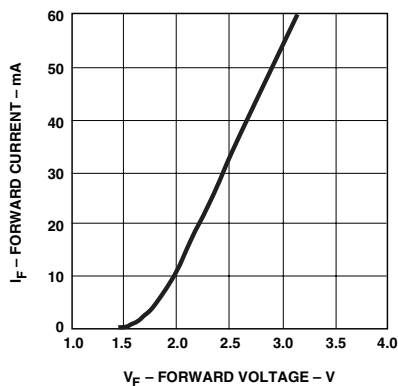

Figure 7. Forward current vs. forward voltage.

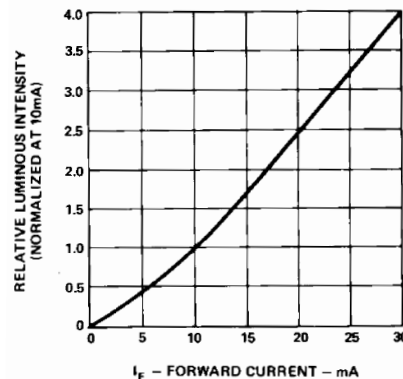

Figure 8. Relative luminous intensity vs. forward current.

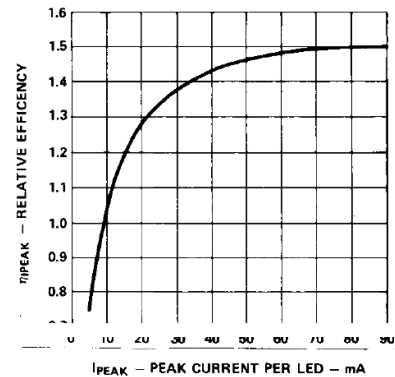

Figure 9. Relative efficiency (luminous intensity per unit current) vs. peak current.

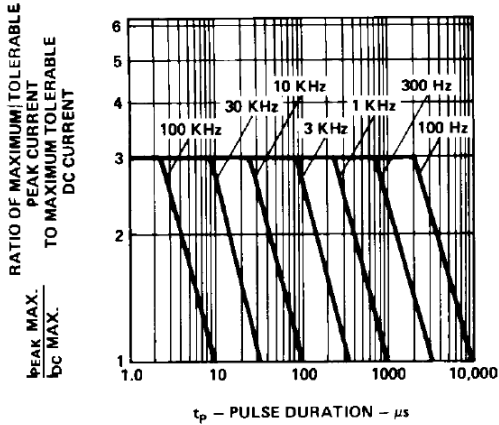

Figure 10. Maximum tolerable peak current vs. pulse duration. ( $I_{DC}$  MAX as per MAX ratings).

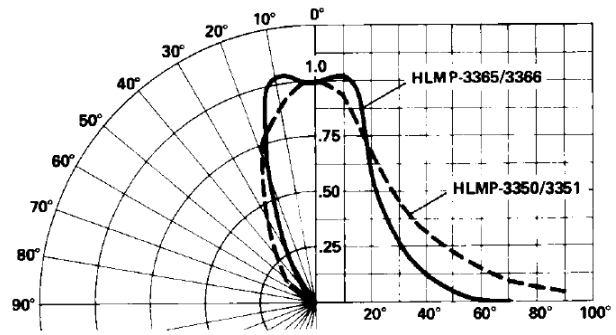

Figure 11. Relative luminous intensity vs. angular displacement.

### Yellow HLMP-345x/-346x Series Electrical Specifications at $T_A = 25^\circ\text{C}$

Symbol	Description	Device HLMP-	Min.	Typ.	Max.	Units	Test Conditions
$2\theta_{1/2}$	Including Angle Between Half Luminous Intensity Points	3466		50 50 45 45		Deg.	Note 1 (Figure 16)
$\lambda_{PEAK}$	Peak Wavelength			583		nm	Measurement at Peak (Figure 1)
$\lambda_d$	Dominant Wavelength			585		nm	Note 2
$\Delta\lambda_{1/2}$	Spectral Line Halfwidth			36		nm	
$\tau_s$	Speed of Response			90		ns	
C	Capacitance			15		pF	$V_F = 0$ ; $f = 1$ MHz
$R\theta_{J-PIN}$	Thermal Resistance			260		$^\circ\text{C}/\text{W}$	Junction to Cathode Lead
$V_F$	Forward Voltage			2.0	2.4	V	$I_F = 10$ mA (Figure 12)
$V_R$	Reverse Breakdown Voltage		5.0			V	$I_R = 100$ $\mu\text{A}$
$\eta_V$	Luminous Efficacy			500		lm/W	Note 3

Notes:

- $\theta_{1/2}$  is the off-axis angle at which the luminous intensity is half the axial luminous intensity.
- Dominant wavelength,  $\lambda_d$ , is derived from the CIE chromaticity diagram and represents the single wavelength which defines the color of the device.
- Radiant Intensity,  $I_e$ , in watts/steradian may be found from the equation  $I_e = I_v/\eta_v$ , where  $I_v$  is the luminous intensity in candelas and  $\eta_v$  is the luminous efficacy in lumens/watt.

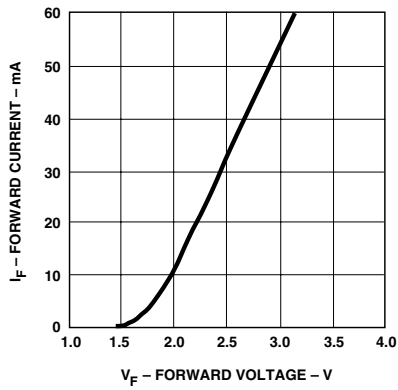

Figure 12. Forward current vs. forward voltage.

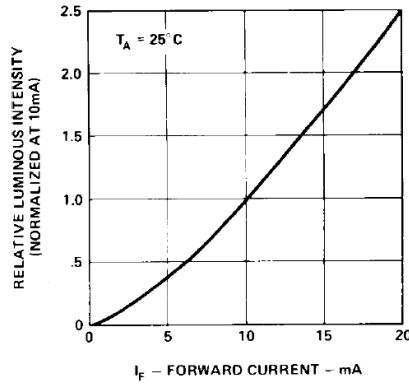

Figure 13. Relative luminous intensity vs. forward current.

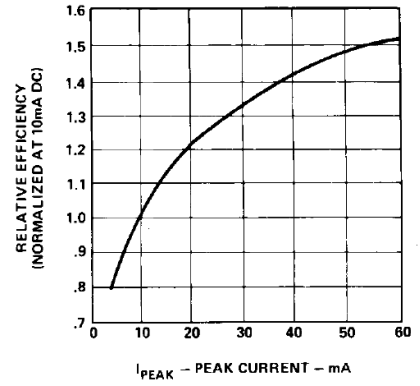

Figure 14. Relative efficiency (luminous intensity per unit current) vs. peak current.

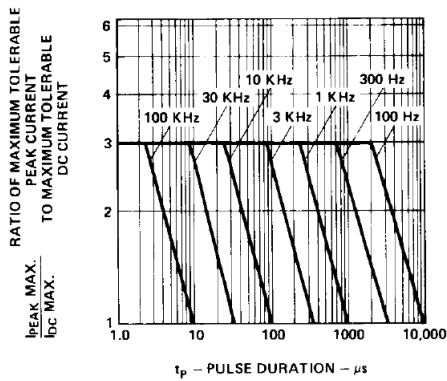

Figure 15. Maximum tolerable peak current vs. pulse duration. ( $I_{DC}$  MAX as per MAX ratings).

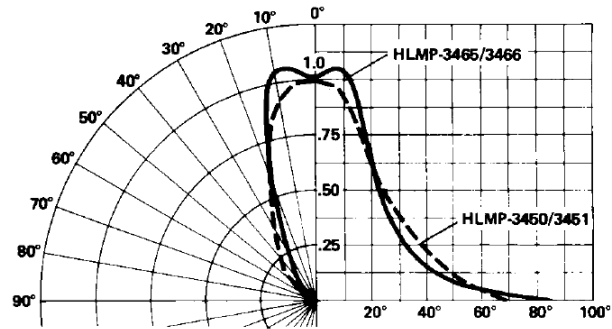

Figure 16. Relative luminous intensity vs. angular displacement.

**Green HLMP-355x/-356x Series**  
**Electrical Specifications at  $T_A = 25^\circ\text{C}$**

Symbol	Description	Device HLMP-	Min.	Typ.	Max.	Units	Test Conditions
$2\theta_{1/2}$	Including Angle Between Half Luminous Intensity Points	3554 3568		50 40		Deg.	Note 1 (Figure 21)
$\lambda_{\text{PEAK}}$	Peak Wavelength			565		nm	Measurement at Peak (Figure 1)
$\lambda_d$	Dominant Wavelength			569		nm	Note 2
$\Delta\lambda_{1/2}$	Spectral Line Halfwidth			28		nm	
$\tau_s$	Speed of Response			500		ns	
C	Capacitance			18		pF	$V_F = 0$ ; $f = 1$ MHz
$R\theta_{\text{J-PIN}}$	Thermal Resistance			260		$^\circ\text{C/W}$	Junction to Cathode Lead
$V_F$	Forward Voltage			2.1	2.7	V	$I_F = 10$ mA (Figure 17)
$V_R$	Reverse Breakdown Voltage		5.0			V	$I_R = 100$ $\mu\text{A}$
$\eta_V$	Luminous Efficacy			595		lm/W	Note 3

Notes:

- $\theta_{1/2}$  is the off-axis angle at which the luminous intensity is half the axial luminous intensity.
- Dominant wavelength,  $\lambda_d$ , is derived from the CIE chromaticity diagram and represents the single wavelength which defines the color of the device.
- Radiant Intensity,  $I_e$ , in watts/steradian may be found from the equation  $I_e = I_v/\eta_v$ , where  $I_v$  is the luminous intensity in candelas and  $\eta_v$  is the luminous efficacy in lumens/watt.

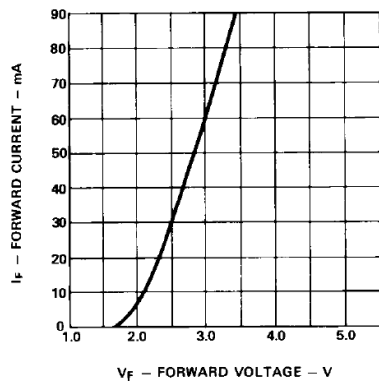

Figure 17. Forward current vs. forward voltage.

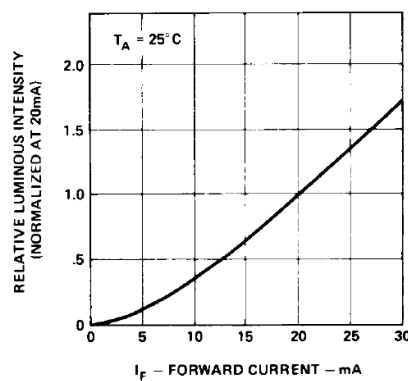

Figure 18. Relative luminous intensity vs. forward current.

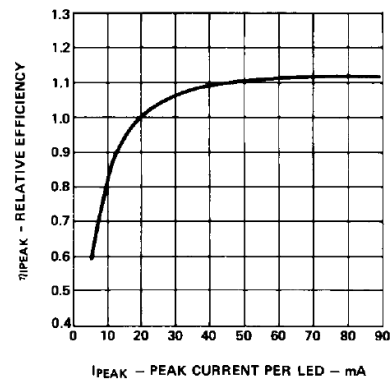

Figure 19. Relative efficiency (luminous intensity per unit current) vs. peak current.

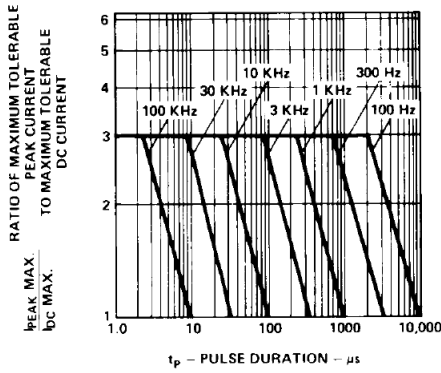

Figure 20. Maximum tolerable peak current vs. pulse duration. ( $I_{DC}$  MAX as per MAX ratings).

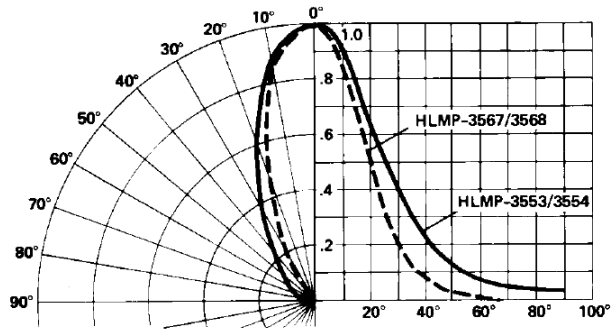

Figure 21. Relative luminous intensity vs. angular displacement.

### Intensity Bin Limits

Color	Bin	Intensity Range (mcd)	
		Min.	Max.
Red	D	2.4	3.8
	E	3.8	6.1
	F	6.1	9.7
	G	9.7	15.5
	H	15.5	24.8
	I	24.8	39.6
	J	39.6	63.4
	K	63.4	101.5
	L	101.5	162.4
	M	162.4	234.6
	N	234.6	340.0
	O	340.0	540.0
	P	540.0	850.0
	Q	850.0	1200.0
	R	1200.0	1700.0
	S	1700.0	2400.0
	T	2400.0	3400.0
	U	3400.0	4900.0
	V	4900.0	7100.0
	W	7100.0	10200.0
X	10200.0	14800.0	
Y	14800.0	21400.0	
Z	21400.0	30900.0	

Color	Bin	Intensity Range (mcd)	
		Min.	Max.
Yellow	D	4.0	6.5
	E	6.5	10.3
	F	10.3	16.6
	G	16.6	26.5
	H	26.5	42.3
	I	42.3	67.7
	J	67.7	108.2
	K	108.2	173.2
	L	173.2	250.0
	M	250.0	360.0
	N	360.0	510.0
	O	510.0	800.0
	P	800.0	1250.0
Q	1250.0	1800.0	
R	1800.0	2900.0	
S	2900.0	4700.0	
T	4700.0	7200.0	
U	7200.0	11700.0	
V	11700.0	18000.0	
W	18000.0	27000.0	

Maximum tolerance for each bin limit is  $\pm 18\%$ .



## Intensity Bin Limits, continued

Color	Bin	Intensity Range (mcd)	
		Min.	Max.
Green	E	7.6	12.0
	F	12.0	19.1
	G	19.1	30.7
	H	30.7	49.1
	I	49.1	78.5
	J	78.5	125.7
	K	125.7	201.1
	L	201.1	289.0
	M	289.0	417.0
	N	417.0	680.0
	O	680.0	1100.0
	P	1100.0	1800.0
	Q	1800.0	2700.0
	R	2700.0	4300.0
	S	4300.0	6800.0
	T	6800.0	10800.0
	U	10800.0	16000.0
V	16000.0	25000.0	
W	25000.0	40000.0	

Maximum tolerance for each bin limit is  $\pm 18\%$ .

## Color Categories

Color	Cat#	Lambda (nm)	
		Min.	Max.
Green	6	561.5	564.5
	5	564.5	567.5
	4	567.5	570.5
	3	570.5	573.5
	2	573.5	576.5
	Yellow	1	582.0
3		584.5	587.0
2		587.0	589.5
4		589.5	592.0
5		592.0	593.0

Maximum tolerance for each bin limit is  $\pm 0.5$  nm.

## Mechanical Option Matrix

Mechanical Option Code	Definition
00	Bulk Packaging, minimum increment 500 pcs/bag
01	Tape & Reel, crimped leads, minimum increment 1300 pcs/bag
02	Tape & Reel, straight leads, minimum increment 1300 pcs/bag
R1	Tape & Reel, crimped leads, reeled counterclockwise, anode leaves first

### Note:

All categories are established for classification of products. Products may not be available in all categories. Please contact your local Avago representative for further clarification/information.

For product information and a complete list of distributors, please go to our web site: [www.avagotech.com](http://www.avagotech.com)

Avago, Avago Technologies, and the A logo are trademarks of Avago Technologies in the United States and other countries. Data subject to change. Copyright © 2005-2008 Avago Technologies. All rights reserved. AV02-1559EN - October 13, 2008





## Стандарт Электрон Связь

Мы молодая и активно развивающаяся компания в области поставок электронных компонентов. Мы поставляем электронные компоненты отечественного и импортного производства напрямую от производителей и с крупнейших складов мира.

Благодаря сотрудничеству с мировыми поставщиками мы осуществляем комплексные и плановые поставки широчайшего спектра электронных компонентов.

Собственная эффективная логистика и склад в обеспечивает надежную поставку продукции в точно указанные сроки по всей России.

Мы осуществляем техническую поддержку нашим клиентам и предпродажную проверку качества продукции. На все поставляемые продукты мы предоставляем гарантию .

Осуществляем поставки продукции под контролем ВП МО РФ на предприятия военно-промышленного комплекса России , а также работаем в рамках 275 ФЗ с открытием отдельных счетов в уполномоченном банке. Система менеджмента качества компании соответствует требованиям ГОСТ ISO 9001.

Минимальные сроки поставки, гибкие цены, неограниченный ассортимент и индивидуальный подход к клиентам являются основой для выстраивания долгосрочного и эффективного сотрудничества с предприятиями радиоэлектронной промышленности, предприятиями ВПК и научно-исследовательскими институтами России.

С нами вы становитесь еще успешнее!

### Наши контакты:

**Телефон:** +7 812 627 14 35

**Электронная почта:** [sales@st-electron.ru](mailto:sales@st-electron.ru)

**Адрес:** 198099, Санкт-Петербург,  
Промышленная ул, дом № 19, литера Н,  
помещение 100-Н Офис 331