

IC for Human Body Detector

# Amplifier for Pyroelectric Infrared Sensor



BD9251FV

No.11096EAT01

## ●Description

BD9251FV is used for the human body detection application.

Make to single-chip, easy to use then before. Power-saving in the best design.

Reduce the standby power requirement of the device used always. Don't choose the mounting place by a space-saving.

## ●Features

- 1) Amplifier for sensor output
- 2) Comparator for sensor output
- 3) Built-in voltage regulator
- 4) Built-in moving detector

## ●Applications

Lighting, Sensor Light, Security system, WEB camera, TV, PC display, Air Conditioner, Ventilation fan

## ●Absolute Maximum Ratings (Ta=25°C)

Parameter	Symbol	Ratings	Units
Supply Voltage	V <sub>DD</sub>	-0.3~7.0	V
Power Dissipation	P <sub>d</sub>	440* <sup>1</sup>	mW
Operating Temperature	T <sub>opr</sub>	-30~75	°C
Storage Temperature	T <sub>stg</sub>	-55~125	°C

\*1. It reduces 3.5mW/°C then Ta≥25°C. (On glass epoxy board of 70mm×70mm×1.6mm)

## ●Operating Conditions

Parameter	Symbol	Ratings			Units	Conditions
		Min.	Typ.	Max.		
Supply Voltage	V <sub>DD</sub>	2.97	5.0	6.0	V	
A1P_IN Offset Voltage	V <sub>A1P_IN_OFFSET</sub>	-	1.5	-	V	V <sub>DRAIN</sub> =2.3V

This product doesn't design for protection radioactive rays.

## ●Electric Characteristics (VDD=5.0V, Ta=25°C)

Parameter	Symbol	Limits			Units	Conditions
		Min.	Typ.	Max.		
Supply Current	I <sub>DD</sub>	-	300	400	uA	Output no load
DRAIN Output Voltage	V <sub>DRAIN</sub>	2.0	2.3	-	V	V <sub>DD</sub> ≥ 2.97V, I <sub>DRAIN</sub> ≤ 100μA
AMP1/AMP2 Input Voltage	V <sub>IN</sub>	0.1	-	V <sub>DD</sub> -0.8	V	
AMP1/AMP2 Gain	A <sub>G</sub>	-	-	46	dB	
AMP1/AMP2 Unity Gain	A <sub>UG</sub>	-	1	-	MHz	
AMP1 Input Offset Voltage	V <sub>A1OFF</sub>	-	-	10	mV	
AMP2 Output Offset Voltage	V <sub>A2OUT</sub>	-	1.5	-	V	
A2_OUT Output Current (source)	I <sub>A2OUT1</sub>	20	30	-	μA	
A2_OUT Output Current (sink)	I <sub>A2OUT2</sub>	20	200	-	μA	
D_OUT / T_OUT Output "H" Voltage	V <sub>OH</sub>	V <sub>DD</sub> -0.6	-	V <sub>DD</sub>	V	I <sub>OH</sub> =-1mA
D_OUT / T_OUT Output "L" Voltage	V <sub>OL</sub>	0	-	0.6	V	I <sub>OL</sub> =+1mA

●Electrical characteristic curves (Reference data)

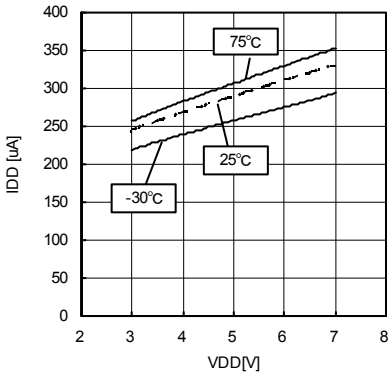

Fig.1 IDD

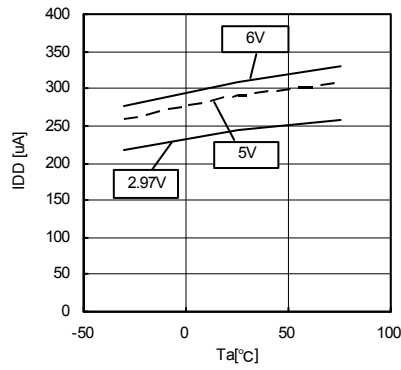

Fig.2 IDD

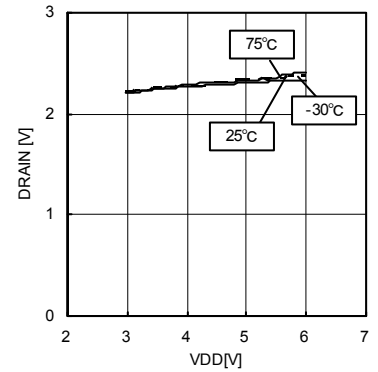

Fig.3 Drain Voltage (source 100μA)

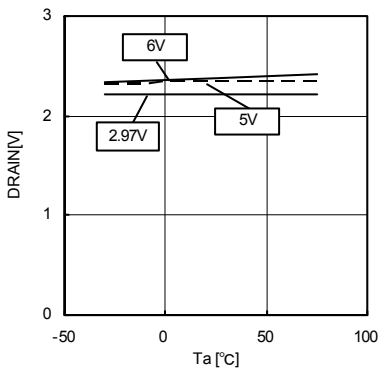

Fig.4 Drain Voltage (source 100μA)

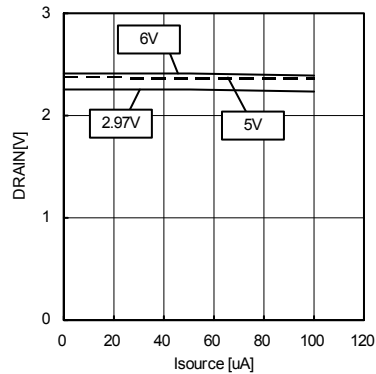

Fig.5 Drain Voltage (Ta=25°C)

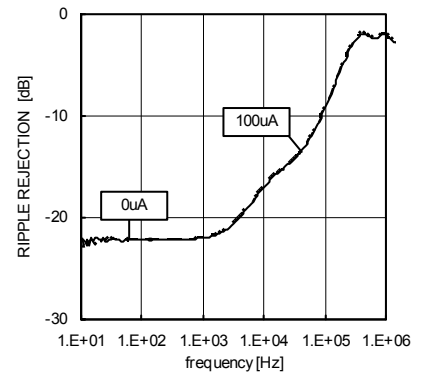

Fig.6 Drain Voltage PSRR (Ta=25°C) VDD=2.97V

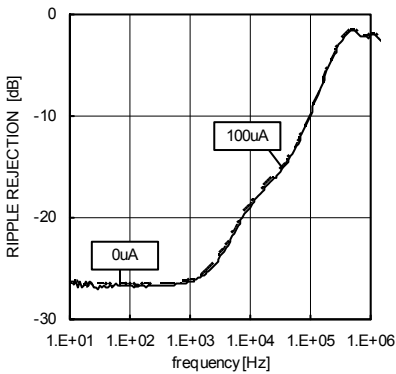

Fig.7 Drain Voltage PSRR (Ta=25°C) VDD=5.0V

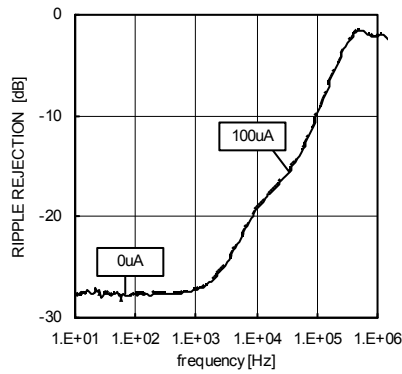

Fig.8 Drain Voltage PSRR (Ta=25°C) VDD=6.0V

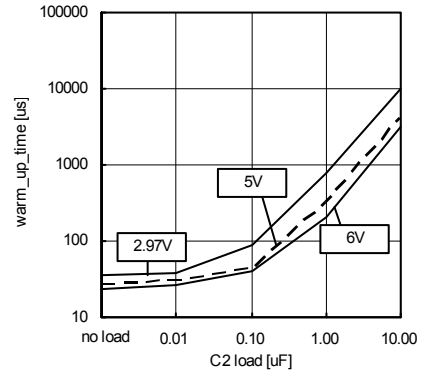

Fig.9 DRAIN VOLTAGE warm\_up\_time (Ta=25°C)

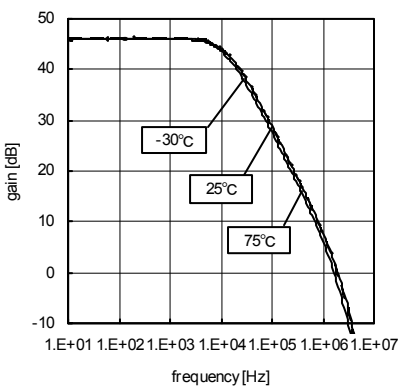

Fig.10 amp1/amp2 closed-loop-gain VDD=2.97V

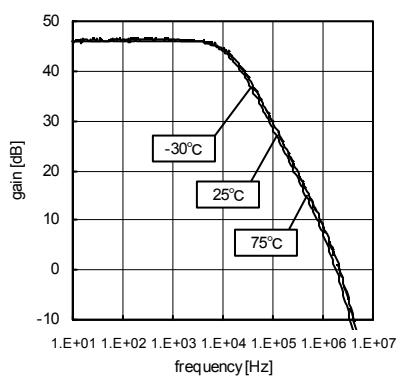

Fig.11 amp1/amp2 closed-loop-gain VDD=5V

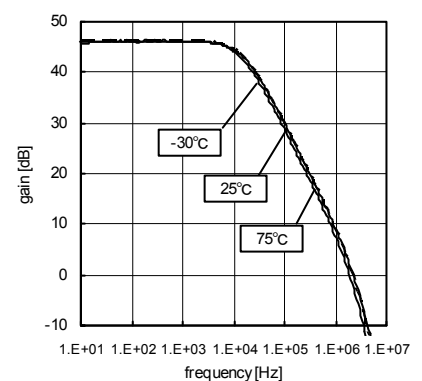

Fig.12 amp1/amp2 closed-loop-gain VDD=6V

●Electrical characteristic curves (Reference data) – Continued

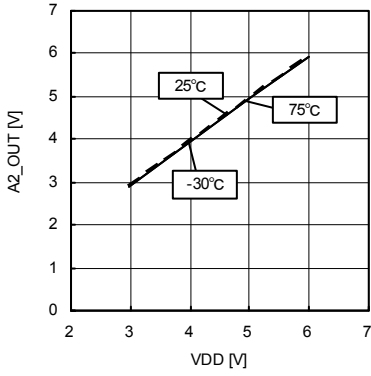

Fig. 13 AMP2 Output High Voltage (source 20uA)

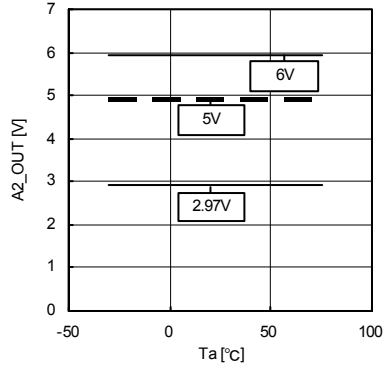

Fig. 14 AMP2 Output High Voltage (source 20uA)

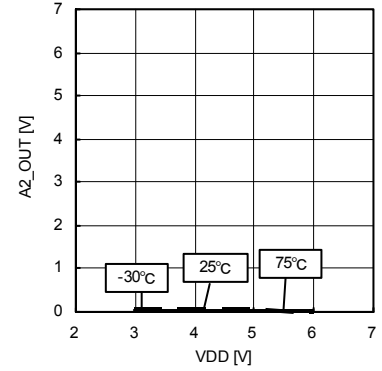

Fig. 15 AMP2 Output Low Voltage (sink 20uA)

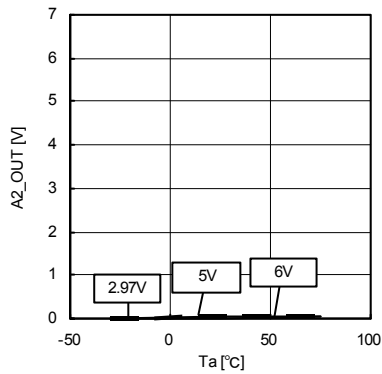

Fig. 16 AMP2 Output Low Voltage (source 20uA)

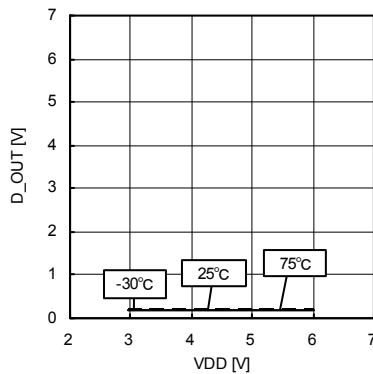

Fig. 17 D\_OUT Output Low Voltage (sink 1mA)

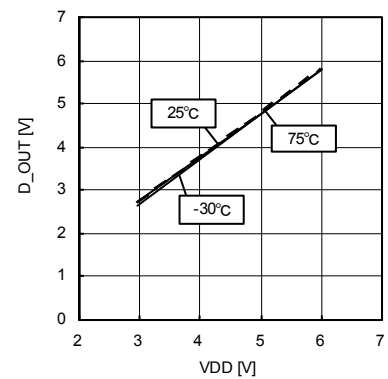

Fig. 18 D\_OUT Output High Voltage (source 1mA)

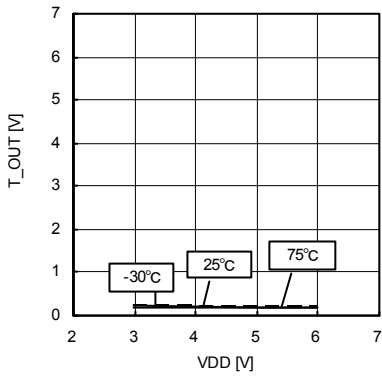

Fig. 19 T\_OUT Output Low Voltage (sink 1mA)

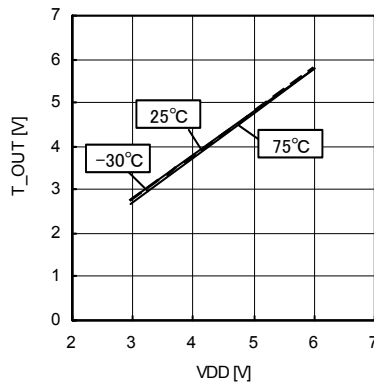
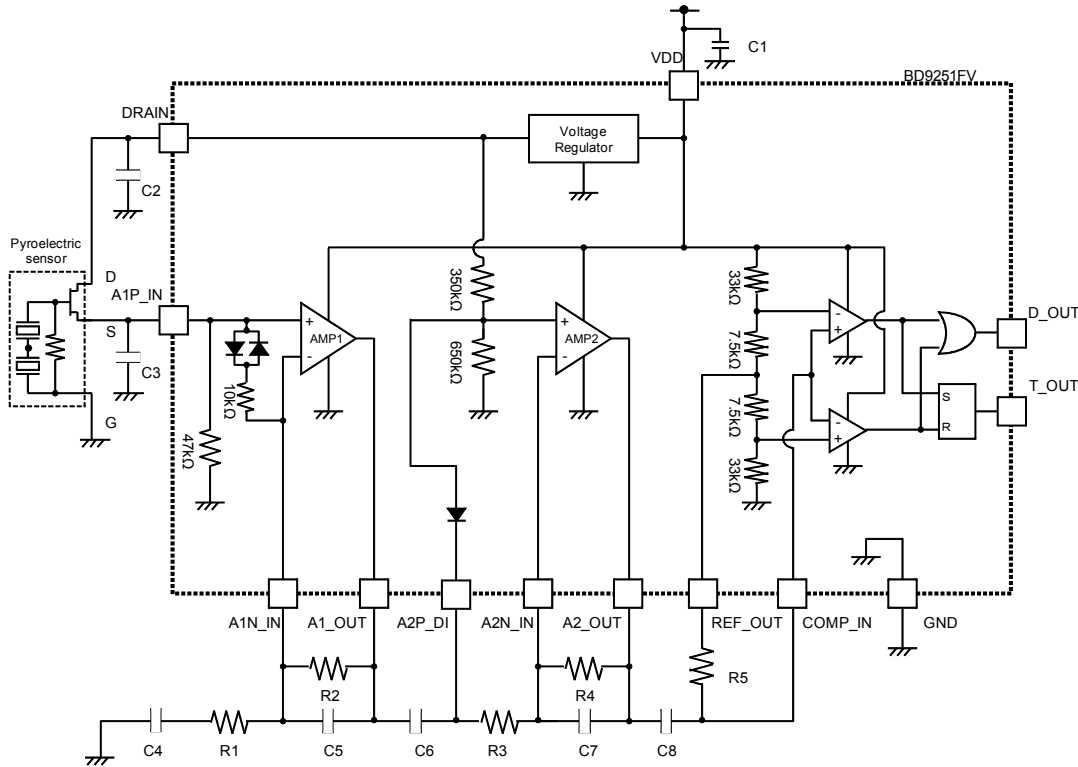

Fig. 20 T\_OUT Output High Voltage (source 1mA)

●Block Diagram/Application



※ Please decide the constant after it confirms it enough examining the characteristic and the condition of the pyroelectric sensor.

Example of circuit constant :

- |          |         |       |         |
|----------|---------|-------|---------|
| C1=C2=C3 | : 1uF   | R1=R3 | : 47kΩ  |
| C4=C6    | : 6.9uF | R2=R4 | : 4.7MΩ |
| C5=C7    | : 15nF  | R5    | : 220kΩ |
| C8       | : 10uF  |       |         |

●PIN Description

PIN No.	PIN Name	Function	Remarks
1	GND	Ground	
2	NC	NC	
3	DRAIN	Power supply for pyroelectric infrared sensor	
4	A1P_IN	Sensor input	
5	A1N_IN	Amp1 n-input	
6	A1_OUT	Amp1 output	
7	A2P_DI	Amp2 diode output	
8	A2N_IN	Amp2 n-input	
9	A2_OUT	Amp2 output, Analog output	
10	REF_OUT	Reference voltage (1/2VDD) output	
11	COMP_IN	Comparator input	
12	D_OUT	Comparator output	
13	T_OUT	Moving detection output	
14	VDD	Power supply	

●Timing chart ( When using dual type pyro sensor )

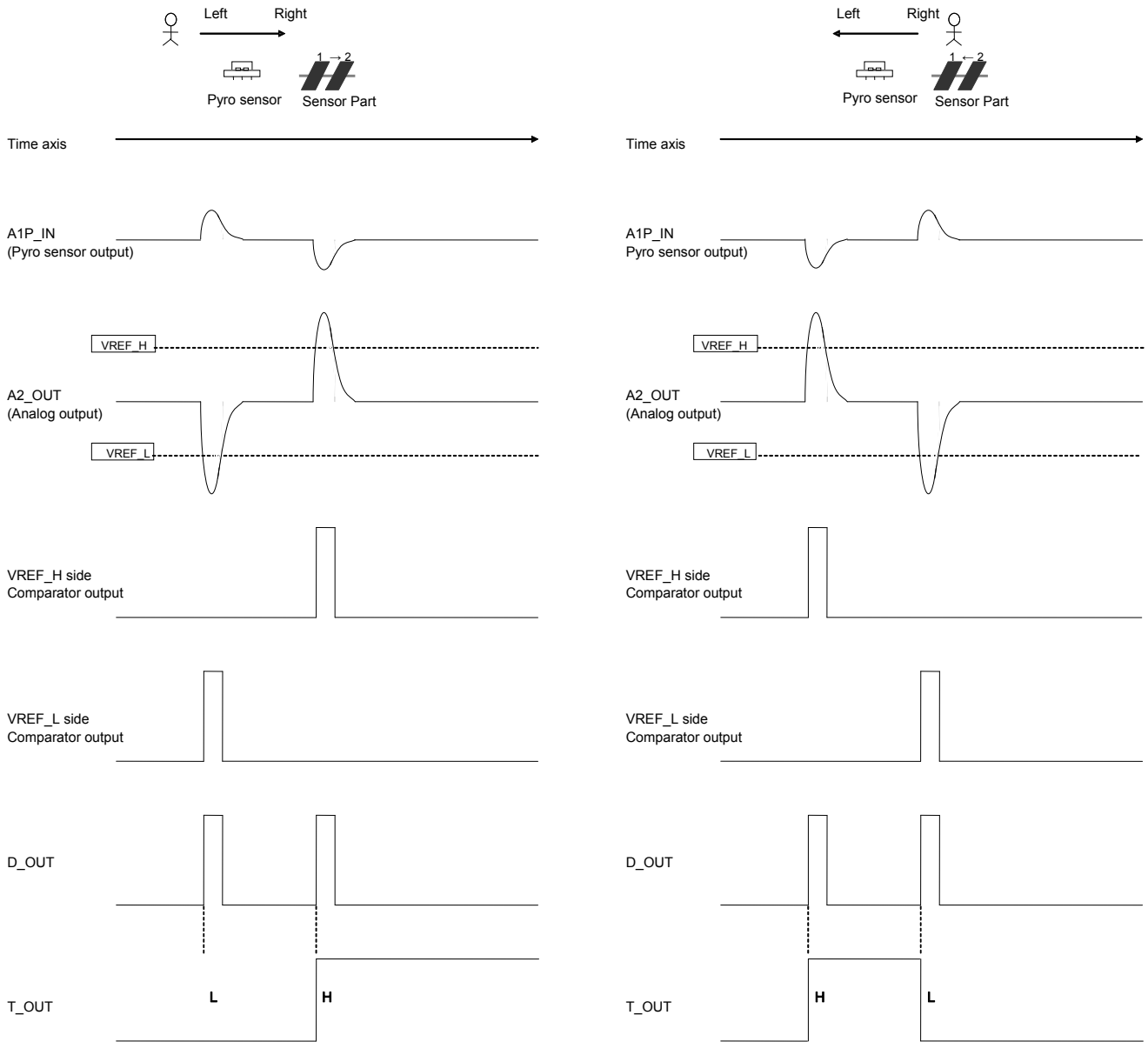

※When using dual type pyro sensor , it's possible to detect the direction of movement by checking the switch of T\_out signal at D\_out=H.

**●Notes for use**

- (1) Absolute maximum ratings  
Use of the IC in excess of absolute maximum ratings such as the applied voltage or operating temperature range may result in IC damage. Assumptions should not be made regarding the state of the IC (short mode or open mode) when such damage is suffered. A physical safety measure such as a fuse should be implemented when use of the IC in a special mode where the absolute maximum ratings may be exceeded is anticipated.
- (2) GND potential  
Ensure a minimum GND pin potential in all operating conditions.
- (3) Short circuit mode between terminals and wrong mounting  
In order to mount the IC on a set PCB, pay thorough attention to the direction and offset of the ICs. Erroneous mounting can destroy the IC. Furthermore, if a short circuit occurs due to foreign matters entering between terminals or between the terminal and the power supply or the GND terminal, the IC can destroy.
- (4) Actions in strong magnetic field  
Use caution when using the IC in the presence of a strong magnetic field as doing so may cause the IC to malfunction.
- (5) Mutual impedance  
Use short and wide wiring tracks for the power supply and ground to keep the mutual impedance as small as possible. Use a capacitor to keep ripple to a minimum.
- (6) About warm-up time  
Operation depends on a power-supply voltage and an external constant for time until stabilizing. Please confirm warm-up time enough when you use it.
- (7) PCB design considerations  
To reduce the noise from OUTPUT to INPUT, COMP\_IN(11pin) and D\_OUT(12pin) and T\_OUT(13pin) lines away from Pyro Sensor and A1P\_IN(4pin).

●Ordering part number

B	D
---	---

Part No.

9	2	5	1
---	---	---	---

Part No.

F	V
---	---

Package  
FV: SSOP-B14

E	2
---	---

Packaging and forming specification  
E2: Embossed tape and reel

SSOP-B14

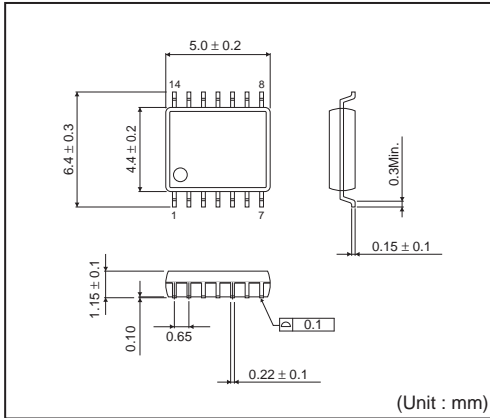

<Tape and Reel information>

Tape	Embossed carrier tape
Quantity	2500pcs
Direction of feed	E2 ( The direction is the 1pin of product is at the upper left when you hold reel on the left hand and you pull out the tape on the right hand )

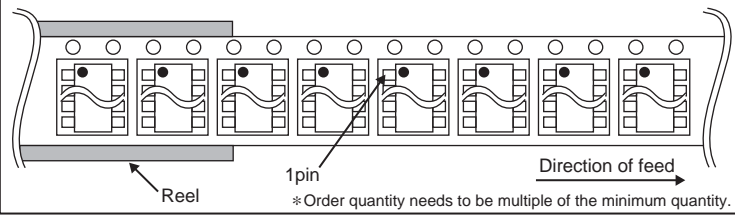



## Notes

No copying or reproduction of this document, in part or in whole, is permitted without the consent of ROHM Co.,Ltd.

The content specified herein is subject to change for improvement without notice.

The content specified herein is for the purpose of introducing ROHM's products (hereinafter "Products"). If you wish to use any such Product, please be sure to refer to the specifications, which can be obtained from ROHM upon request.

Examples of application circuits, circuit constants and any other information contained herein illustrate the standard usage and operations of the Products. The peripheral conditions must be taken into account when designing circuits for mass production.

Great care was taken in ensuring the accuracy of the information specified in this document. However, should you incur any damage arising from any inaccuracy or misprint of such information, ROHM shall bear no responsibility for such damage.

The technical information specified herein is intended only to show the typical functions of and examples of application circuits for the Products. ROHM does not grant you, explicitly or implicitly, any license to use or exercise intellectual property or other rights held by ROHM and other parties. ROHM shall bear no responsibility whatsoever for any dispute arising from the use of such technical information.

The Products specified in this document are intended to be used with general-use electronic equipment or devices (such as audio visual equipment, office-automation equipment, communication devices, electronic appliances and amusement devices).

The Products specified in this document are not designed to be radiation tolerant.

While ROHM always makes efforts to enhance the quality and reliability of its Products, a Product may fail or malfunction for a variety of reasons.

Please be sure to implement in your equipment using the Products safety measures to guard against the possibility of physical injury, fire or any other damage caused in the event of the failure of any Product, such as derating, redundancy, fire control and fail-safe designs. ROHM shall bear no responsibility whatsoever for your use of any Product outside of the prescribed scope or not in accordance with the instruction manual.

The Products are not designed or manufactured to be used with any equipment, device or system which requires an extremely high level of reliability the failure or malfunction of which may result in a direct threat to human life or create a risk of human injury (such as a medical instrument, transportation equipment, aerospace machinery, nuclear-reactor controller, fuel-controller or other safety device). ROHM shall bear no responsibility in any way for use of any of the Products for the above special purposes. If a Product is intended to be used for any such special purpose, please contact a ROHM sales representative before purchasing.

If you intend to export or ship overseas any Product or technology specified herein that may be controlled under the Foreign Exchange and the Foreign Trade Law, you will be required to obtain a license or permit under the Law.



Thank you for your accessing to ROHM product informations.  
More detail product informations and catalogs are available, please contact us.

### ROHM Customer Support System

<http://www.rohm.com/contact/>



## Стандарт Электрон Связь

Мы молодая и активно развивающаяся компания в области поставок электронных компонентов. Мы поставляем электронные компоненты отечественного и импортного производства напрямую от производителей и с крупнейших складов мира.

Благодаря сотрудничеству с мировыми поставщиками мы осуществляем комплексные и плановые поставки широчайшего спектра электронных компонентов.

Собственная эффективная логистика и склад в обеспечивает надежную поставку продукции в точно указанные сроки по всей России.

Мы осуществляем техническую поддержку нашим клиентам и предпродажную проверку качества продукции. На все поставляемые продукты мы предоставляем гарантию .

Осуществляем поставки продукции под контролем ВП МО РФ на предприятия военно-промышленного комплекса России , а также работаем в рамках 275 ФЗ с открытием отдельных счетов в уполномоченном банке. Система менеджмента качества компании соответствует требованиям ГОСТ ISO 9001.

Минимальные сроки поставки, гибкие цены, неограниченный ассортимент и индивидуальный подход к клиентам являются основой для выстраивания долгосрочного и эффективного сотрудничества с предприятиями радиоэлектронной промышленности, предприятиями ВПК и научно-исследовательскими институтами России.

С нами вы становитесь еще успешнее!

### Наши контакты:

**Телефон:** +7 812 627 14 35

**Электронная почта:** [sales@st-electron.ru](mailto:sales@st-electron.ru)

**Адрес:** 198099, Санкт-Петербург,  
Промышленная ул, дом № 19, литера Н,  
помещение 100-Н Офис 331