



Is Now Part of



**ON Semiconductor®**

To learn more about ON Semiconductor, please visit our website at  
[www.onsemi.com](http://www.onsemi.com)

Please note: As part of the Fairchild Semiconductor integration, some of the Fairchild orderable part numbers will need to change in order to meet ON Semiconductor's system requirements. Since the ON Semiconductor product management systems do not have the ability to manage part nomenclature that utilizes an underscore (\_), the underscore (\_) in the Fairchild part numbers will be changed to a dash (-). This document may contain device numbers with an underscore (\_). Please check the ON Semiconductor website to verify the updated device numbers. The most current and up-to-date ordering information can be found at [www.onsemi.com](http://www.onsemi.com). Please email any questions regarding the system integration to [Fairchild\\_questions@onsemi.com](mailto:Fairchild_questions@onsemi.com).

ON Semiconductor and the ON Semiconductor logo are trademarks of Semiconductor Components Industries, LLC dba ON Semiconductor or its subsidiaries in the United States and/or other countries. ON Semiconductor owns the rights to a number of patents, trademarks, copyrights, trade secrets, and other intellectual property. A listing of ON Semiconductor's product/patent coverage may be accessed at [www.onsemi.com/site/pdf/Patent-Marking.pdf](http://www.onsemi.com/site/pdf/Patent-Marking.pdf). ON Semiconductor reserves the right to make changes without further notice to any products herein. ON Semiconductor makes no warranty, representation or guarantee regarding the suitability of its products for any particular purpose, nor does ON Semiconductor assume any liability arising out of the application or use of any product or circuit, and specifically disclaims any and all liability, including without limitation special, consequential or incidental damages. Buyer is responsible for its products and applications using ON Semiconductor products, including compliance with all laws, regulations and safety requirements or standards, regardless of any support or applications information provided by ON Semiconductor. "Typical" parameters which may be provided in ON Semiconductor data sheets and/or specifications can and do vary in different applications and actual performance may vary over time. All operating parameters, including "Typicals" must be validated for each customer application by customer's technical experts. ON Semiconductor does not convey any license under its patent rights nor the rights of others. ON Semiconductor products are not designed, intended, or authorized for use as a critical component in life support systems or any FDA Class 3 medical devices or medical devices with a same or similar classification in a foreign jurisdiction or any devices intended for implantation in the human body. Should Buyer purchase or use ON Semiconductor products for any such unintended or unauthorized application, Buyer shall indemnify and hold ON Semiconductor and its officers, employees, subsidiaries, affiliates, and distributors harmless against all claims, costs, damages, and expenses, and reasonable attorney fees arising out of, directly or indirectly, any claim of personal injury or death associated with such unintended or unauthorized use, even if such claim alleges that ON Semiconductor was negligent regarding the design or manufacture of the part. ON Semiconductor is an Equal Opportunity/Affirmative Action Employer. This literature is subject to all applicable copyright laws and is not for resale in any manner.

## NC7S14 TinyLogic® HS Inverter with Schmitt Trigger Input

### General Description

The NC7S14 is a single high performance CMOS Inverter with Schmitt Trigger input. The circuit design provides hysteresis between the positive-going and negative going input thresholds thereby improving noise margins.

Advanced Silicon Gate CMOS fabrication assures high speed and low power circuit operation over a broad  $V_{CC}$  range. ESD protection diodes inherently guard both input and output with respect to the  $V_{CC}$  and GND rails.

### Features

- Space saving SOT23 or SC70 5-lead package
- Ultra small MicroPak™ leadless package
- Schmitt input hysteresis: > 1V typ
- High speed:  $t_{PD}$  4.5 ns typ
- Low quiescent power:  $I_{CC} < 1 \mu A$
- Balanced output drive: 2 mA  $I_{OL}$ , -2 mA  $I_{OH}$
- Broad  $V_{CC}$  operating range: 2V – 6V
- Balanced propagation delays
- Specified for 3V operation

### Ordering Code:

Order Number	Package Number	Package Top Mark	Package Description	Supplied As
NC7S14M5X	MA05B	7S14	5-Lead SOT23, JEDEC MO-178, 1.6mm	3k Units on Tape and Reel
NC7S14P5X	MAA05A	S14	5-Lead SC70, EIAJ SC-88a, 1.25mm Wide	3k Units on Tape and Reel
NC7S14L6X	MAC06A	UU	6-Lead MicroPak, 1.0mm Wide	5k Units on Tape and Reel

### Logic Symbol

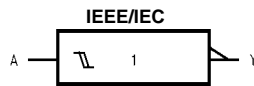

### Pin Descriptions

Pin Names	Description
A	Input
Y	Output
NC	No Connect

### Function Table

$$Y = \bar{A}$$

Input	Output
A	Y
L	H
H	L

H = HIGH Logic Level  
L = LOW Logic Level

### Connection Diagrams

#### Pin Assignments for SC70 and SOT23

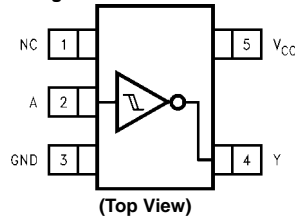

#### Pad Assignments for MicroPak

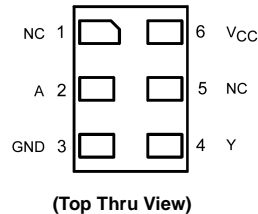

TinyLogic® is a registered trademark of Fairchild Semiconductor Corporation.  
MicroPak™ is a trademark of Fairchild Semiconductor Corporation.

**Absolute Maximum Ratings**(Note 1)

Supply Voltage ( $V_{CC}$ )	-0.5V to +7.0V
DC Input Diode Current ( $I_{IK}$ )	
@ $V_{IN} \leq -0.5V$	-20 mA
@ $V_{IN} \geq V_{CC} + 0.5V$	+20 mA
DC Input Voltage ( $V_{IN}$ )	-0.5V to $V_{CC} + 0.5V$
DC Output Diode Current ( $I_{OK}$ )	
@ $V_{OUT} < -0.5V$	-20 mA
@ $V_{OUT} > V_{CC} + 0.5V$	+20 mA
DC Output Voltage ( $V_{OUT}$ )	-0.5V to $V_{CC} + 0.5V$
DC Output Source or Sink Current ( $I_{OUT}$ )	$\pm 12.5$ mA
DC $V_{CC}$ or Ground Current per Output Pin ( $I_{CC}$ or $I_{GND}$ )	$\pm 25$ mA
Storage Temperature ( $T_{STG}$ )	-65°C to +150°C
Junction Temperature ( $T_J$ )	150°C
Lead Temperature ( $T_L$ ) (Soldering, 10 seconds)	260°C
Power Dissipation ( $P_D$ ) @ +85°C	
SOT23-5	200 mW
SC70-5	150 mW

**Recommended Operating Conditions** (Note 2)

Supply Voltage ( $V_{CC}$ )	2.0V to 6.0V
Input Voltage ( $V_{IN}$ )	0V to $V_{CC}$
Output Voltage ( $V_{OUT}$ )	0V to $V_{CC}$
Operating Temperature ( $T_A$ )	-40°C to +85°C
Thermal Resistance ( $\theta_{JA}$ )	
SOT23-5	300°C/W
SC70-5	425°C/W

**Note 1:** Absolute maximum ratings are those values beyond which damage to the device may occur. The databook specifications should be met, without exception, to ensure that the system design is reliable over its power supply, temperature, and output/input loading variables. Fairchild does not recommend operation of circuits outside the databook specifications.

**Note 2:** Unused inputs must be held HIGH or LOW. They may not float.

**DC Electrical Characteristics**

Symbol	Parameter	$V_{CC}$ (V)	$T_A = +25^\circ\text{C}$			$T_A = -40^\circ\text{C to } +85^\circ\text{C}$		Units	Conditions		
			Min	Typ	Max	Min	Max				
$V_P$	Positive Threshold Voltage	2.0	1.0	1.29	1.5	1.0	1.6	V			
		3.0	1.5	1.90	2.2	1.5	2.2				
		4.5	2.3	2.73	3.15	2.3	3.15				
		6.0	3.0	3.56	4.2	3.0	4.2				
$V_N$	Negative Threshold Voltage	2.0	0.3	0.70	0.9	0.3	0.9	V			
		3.0	0.6	1.05	1.35	0.6	1.35				
		4.5	1.13	1.66	2.0	1.13	2.0				
		6.0	1.5	2.24	2.6	1.5	2.6				
$V_H$	Hysteresis Voltage	2.0	0.3	0.59	1.0	0.3	1.0	V			
		3.0	0.4	0.85	1.3	0.4	1.3				
		4.5	0.6	1.08	1.4	0.6	1.4				
		6.0	0.8	1.31	1.7	0.8	1.7				
$V_{OH}$	HIGH Level Output Voltage	2.0	1.90	2.0		1.90		V	$I_{OH} = -20 \mu\text{A}$ $V_{IN} = V_{IL}$		
		3.0	2.90	3.0		2.90					
		4.5	4.40	4.5		4.40					
		6.0	5.90	6.0		5.90					
				3.0	2.68	2.87		2.63	V	$V_{IN} = V_{IL}$ $I_{OH} = -1.3 \text{ mA}$ $I_{OH} = -2 \text{ mA}$ $I_{OH} = -2.6 \text{ mA}$	
				4.5	4.18	4.37		4.13			
				6.0	5.68	5.86		5.63			
$V_{OL}$	LOW Level Output Voltage	2.0		0.0	0.10		0.10	V	$I_{OH} = 20 \mu\text{A}$ $V_{IN} = V_{IH}$		
		3.0		0.0	0.10		0.10				
		4.5		0.0	0.10		0.10				
		6.0		0.0	0.10		0.10				
				3.0		0.1	0.26		0.33	V	$V_{IN} = V_{IH}$ $I_{OL} = 1.3 \text{ mA}$ $I_{OL} = 2 \text{ mA}$ $I_{OL} = 2.6 \text{ mA}$
				4.5		0.1	0.26		0.33		
				6.0		0.1	0.26		0.33		

## DC Electrical Characteristics (Continued)

Symbol	Parameter	V <sub>CC</sub> (V)	T <sub>A</sub> = +25°C			T <sub>A</sub> = -40°C to +85°C		Units	Conditions
			Min	Typ	Max	Min	Max		
I <sub>IN</sub>	Input Leakage Current	6.0			±0.1			μA	V <sub>IN</sub> = V <sub>CC</sub> , GND
I <sub>CC</sub>	Quiescent Supply Current	6.0			1.0			μA	V <sub>IN</sub> = V <sub>CC</sub> , GND

## AC Electrical Characteristics

Symbol	Parameter	V <sub>CC</sub> (V)	T <sub>A</sub> = +25°C			T <sub>A</sub> = -40°C to +85°C		Units	Conditions	Figure Number
			Min	Typ	Max	Min	Max			
t <sub>PLH</sub>	Propagation Delay	5.0		4.5	21			ns	C <sub>L</sub> = 15 pF	Figures 1, 3
t <sub>PHL</sub>		2.0		20	100		125		C <sub>L</sub> = 50 pF	
		3.0		12	27		35			
		4.5		8.5	20		25			
		6.0		7.5	17		21			
t <sub>TLH</sub>	Output Transition Time	5.0		3	8			ns	C <sub>L</sub> = 15 pF	Figures 1, 3
t <sub>THL</sub>		2.0		25	125		145		C <sub>L</sub> = 50 pF	
		3.0		16	35		45			
		4.5		11	25		30			
		6.0		9	21		24			
C <sub>IN</sub>	Input Capacitance	Open		2	10			10	pF	
C <sub>PD</sub>	Power Dissipation Capacitance	5.0		7					pF	(Note 3) Figure 2

**Note 3:** C<sub>PD</sub> is defined as the value of the internal equivalent capacitance which is derived from dynamic operating current consumption (I<sub>CCD</sub>) at no output loading and operating at 50% duty cycle. (See Figure 2.) C<sub>PD</sub> is related to I<sub>CCD</sub> dynamic operating current by the expression:  
 $I_{CCD} = (C_{PD})(V_{CC})(f_{IN}) + (I_{CCstatic})$ .

## AC Loading and Waveforms

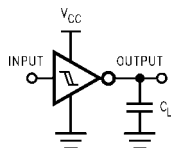

C<sub>L</sub> includes load and stray capacitance  
 Input PRR = 1.0 MHz, t<sub>w</sub> = 500 ns

**FIGURE 1. AC Test Circuit**

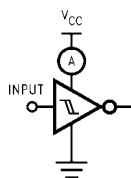

Input = AC Waveforms;  
 PRR = variable; Duty Cycle = 50%

**FIGURE 2. I<sub>CCD</sub> Test Circuit**

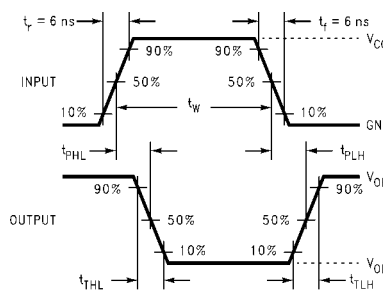

**FIGURE 3. AC Waveforms**

### Tape and Reel Specification

**TAPE FORMAT for SC70 and SOT23**

Package Designator	Tape Section	Number Cavities	Cavity Status	Cover Tape Status
M5X, P5X	Leader (Start End)	125 (typ)	Empty	Sealed
	Carrier	3000	Filled	Sealed
	Trailer (Hub End)	75 (typ)	Empty	Sealed

**TAPE DIMENSIONS** inches (millimeters)



Package	Tape Size	DIM A	DIM B	DIM F	DIM $K_o$	DIM P1	DIM W
SC70-5	8 mm	0.093 (2.35)	0.096 (2.45)	0.138 ± 0.004 (3.5 ± 0.10)	0.053 ± 0.004 (1.35 ± 0.10)	0.157 (4)	0.315 ± 0.004 (8 ± 0.1)
SOT23-5	8 mm	0.130 (3.3)	0.130 (3.3)	0.138 ± 0.002 (3.5 ± 0.05)	0.055 ± 0.004 (1.4 ± 0.11)	0.157 (4)	0.315 ± 0.012 (8 ± 0.3)

### Tape and Reel Specification (Continued)

#### TAPE FORMAT for MircoPak

Package Designator	Tape Section	Number Cavities	Cavity Status	Cover Tape Status
L6X	Leader (Start End)	125 (typ)	Empty	Sealed
	Carrier	5000	Filled	Sealed
	Trailer (Hub End)	75 (typ)	Empty	Sealed

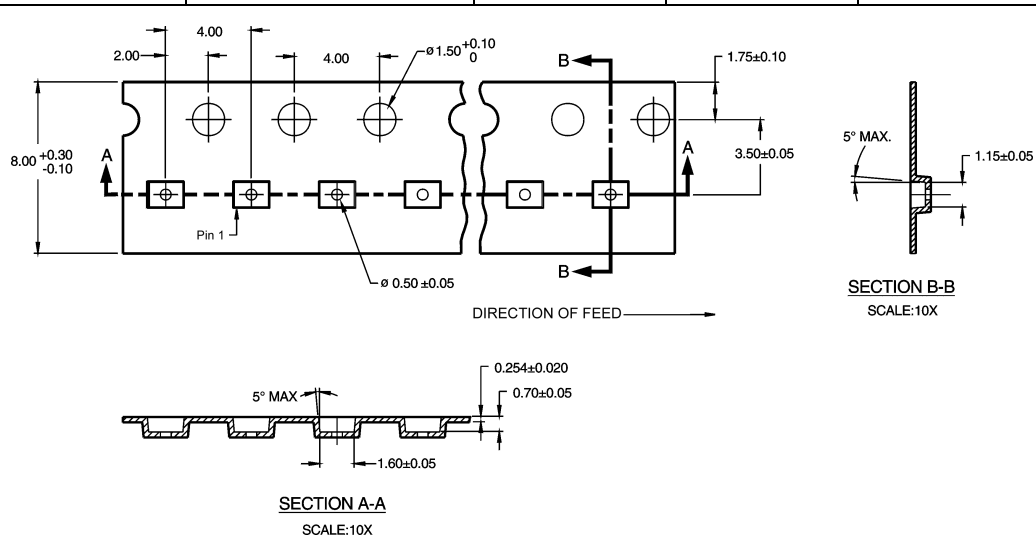

#### REEL DIMENSIONS inches (millimeters)



Tape Size	A	B	C	D	N	W1	W2	W3
8 mm	7.0 (177.8)	0.059 (1.50)	0.512 (13.00)	0.795 (20.20)	2.165 (55.00)	0.331 +0.059/-0.000 (8.40 +1.50/-0.00)	0.567 (14.40)	W1 +0.078/-0.039 (W1 +2.00/-1.00)

**Physical Dimensions** inches (millimeters) unless otherwise noted

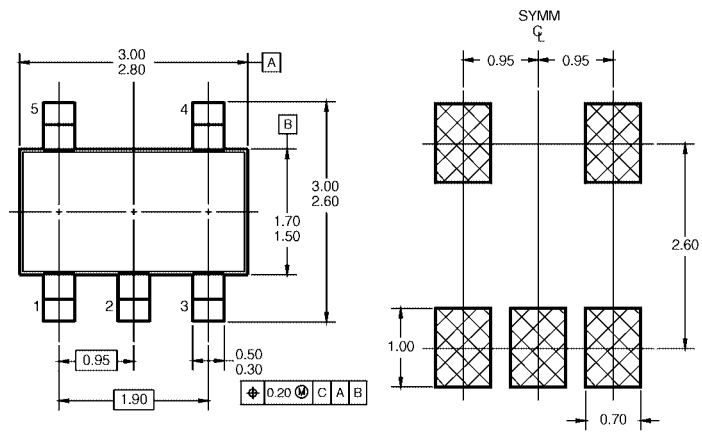

LAND PATTERN RECOMMENDATION

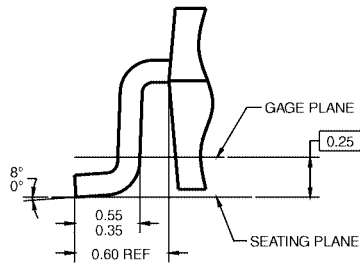
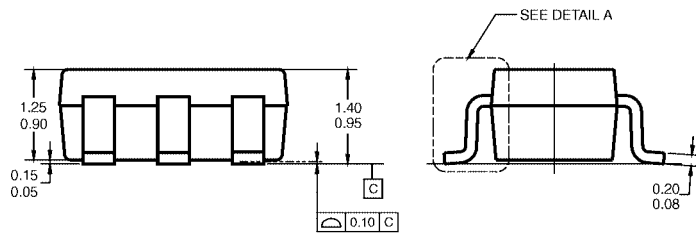

DETAIL A

- NOTES: UNLESS OTHERWISE SPECIFIED  
 A) THIS PACKAGE CONFORMS TO JEDEC MO-178, ISSUE B, VARIATION AA, DATED JANUARY 1999.  
 B) ALL DIMENSIONS ARE IN MILLIMETERS.

MA05BRevC

**5-Lead SOT23, JEDEC MO-178, 1.6mm  
 Package Number MA05B**

**Physical Dimensions** inches (millimeters) unless otherwise noted (Continued)



NOTES:

- A. CONFORMS TO EIAJ REGISTERED OUTLINE DRAWING SC88A.
- B. DIMENSIONS DO NOT INCLUDE BURRS OR MOLD FLASH.
- C. DIMENSIONS ARE IN MILLIMETERS.

MAA05ARevC

**5-Lead SC70, EIAJ SC-88a, 1.25mm Wide  
Package Number MAA05A**



**Physical Dimensions** inches (millimeters) unless otherwise noted (Continued)



**Notes:**

1. JEDEC PACKAGE REGISTRATION IS ANTICIPATED
2. DIMENSIONS ARE IN MILLIMETERS
3. DRAWING CONFORMS TO ASME Y14.5M-1994

MAC06ARevB

**6-Lead MicroPak, 1.0mm Wide  
Package Number MAC06A**

Fairchild does not assume any responsibility for use of any circuitry described, no circuit patent licenses are implied and Fairchild reserves the right at any time without notice to change said circuitry and specifications.

**LIFE SUPPORT POLICY**

FAIRCHILD'S PRODUCTS ARE NOT AUTHORIZED FOR USE AS CRITICAL COMPONENTS IN LIFE SUPPORT DEVICES OR SYSTEMS WITHOUT THE EXPRESS WRITTEN APPROVAL OF THE PRESIDENT OF FAIRCHILD SEMICONDUCTOR CORPORATION. As used herein:

1. Life support devices or systems are devices or systems which, (a) are intended for surgical implant into the body, or (b) support or sustain life, and (c) whose failure to perform when properly used in accordance with instructions for use provided in the labeling, can be reasonably expected to result in a significant injury to the user.
2. A critical component in any component of a life support device or system whose failure to perform can be reasonably expected to cause the failure of the life support device or system, or to affect its safety or effectiveness.

[www.fairchildsemi.com](http://www.fairchildsemi.com)

ON Semiconductor and  are trademarks of Semiconductor Components Industries, LLC dba ON Semiconductor or its subsidiaries in the United States and/or other countries. ON Semiconductor owns the rights to a number of patents, trademarks, copyrights, trade secrets, and other intellectual property. A listing of ON Semiconductor's product/patent coverage may be accessed at [www.onsemi.com/site/pdf/Patent-Marking.pdf](http://www.onsemi.com/site/pdf/Patent-Marking.pdf). ON Semiconductor reserves the right to make changes without further notice to any products herein. ON Semiconductor makes no warranty, representation or guarantee regarding the suitability of its products for any particular purpose, nor does ON Semiconductor assume any liability arising out of the application or use of any product or circuit, and specifically disclaims any and all liability, including without limitation special, consequential or incidental damages. Buyer is responsible for its products and applications using ON Semiconductor products, including compliance with all laws, regulations and safety requirements or standards, regardless of any support or applications information provided by ON Semiconductor. "Typical" parameters which may be provided in ON Semiconductor data sheets and/or specifications can and do vary in different applications and actual performance may vary over time. All operating parameters, including "Typicals" must be validated for each customer application by customer's technical experts. ON Semiconductor does not convey any license under its patent rights nor the rights of others. ON Semiconductor products are not designed, intended, or authorized for use as a critical component in life support systems or any FDA Class 3 medical devices or medical devices with a same or similar classification in a foreign jurisdiction or any devices intended for implantation in the human body. Should Buyer purchase or use ON Semiconductor products for any such unintended or unauthorized application, Buyer shall indemnify and hold ON Semiconductor and its officers, employees, subsidiaries, affiliates, and distributors harmless against all claims, costs, damages, and expenses, and reasonable attorney fees arising out of, directly or indirectly, any claim of personal injury or death associated with such unintended or unauthorized use, even if such claim alleges that ON Semiconductor was negligent regarding the design or manufacture of the part. ON Semiconductor is an Equal Opportunity/Affirmative Action Employer. This literature is subject to all applicable copyright laws and is not for resale in any manner.

## PUBLICATION ORDERING INFORMATION

### LITERATURE FULFILLMENT:

Literature Distribution Center for ON Semiconductor  
19521 E. 32nd Pkwy, Aurora, Colorado 80011 USA  
**Phone:** 303-675-2175 or 800-344-3860 Toll Free USA/Canada  
**Fax:** 303-675-2176 or 800-344-3867 Toll Free USA/Canada  
**Email:** [orderlit@onsemi.com](mailto:orderlit@onsemi.com)

**N. American Technical Support:** 800-282-9855 Toll Free  
USA/Canada  
**Europe, Middle East and Africa Technical Support:**  
Phone: 421 33 790 2910  
**Japan Customer Focus Center**  
Phone: 81-3-5817-1050

**ON Semiconductor Website:** [www.onsemi.com](http://www.onsemi.com)  
**Order Literature:** <http://www.onsemi.com/orderlit>  
For additional information, please contact your local  
Sales Representative

# Mouser Electronics

Authorized Distributor

Click to View Pricing, Inventory, Delivery & Lifecycle Information:

[ON Semiconductor:](#)

[NC7S14M5X](#) [NC7S14M5](#) [NC7S14P5](#) [NC7S14L6X](#) [NC7S14P5X](#)



## Стандарт Электрон Связь

Мы молодая и активно развивающаяся компания в области поставок электронных компонентов. Мы поставляем электронные компоненты отечественного и импортного производства напрямую от производителей и с крупнейших складов мира.

Благодаря сотрудничеству с мировыми поставщиками мы осуществляем комплексные и плановые поставки широчайшего спектра электронных компонентов.

Собственная эффективная логистика и склад в обеспечивает надежную поставку продукции в точно указанные сроки по всей России.

Мы осуществляем техническую поддержку нашим клиентам и предпродажную проверку качества продукции. На все поставляемые продукты мы предоставляем гарантию .

Осуществляем поставки продукции под контролем ВП МО РФ на предприятия военно-промышленного комплекса России , а также работаем в рамках 275 ФЗ с открытием отдельных счетов в уполномоченном банке. Система менеджмента качества компании соответствует требованиям ГОСТ ISO 9001.

Минимальные сроки поставки, гибкие цены, неограниченный ассортимент и индивидуальный подход к клиентам являются основой для выстраивания долгосрочного и эффективного сотрудничества с предприятиями радиоэлектронной промышленности, предприятиями ВПК и научно-исследовательскими институтами России.

С нами вы становитесь еще успешнее!

### Наши контакты:

**Телефон:** +7 812 627 14 35

**Электронная почта:** [sales@st-electron.ru](mailto:sales@st-electron.ru)

**Адрес:** 198099, Санкт-Петербург,  
Промышленная ул, дом № 19, литера Н,  
помещение 100-Н Офис 331