

Complementary Plastic Power Transistors

NPN/PNP Silicon DPAK For Surface Mount Applications



ON Semiconductor®

www.onsemi.com

MJD200 (NPN), MJD210 (PNP)

Designed for low voltage, low-power, high-gain audio amplifier applications.

Features

- High DC Current Gain
- Lead Formed for Surface Mount Applications in Plastic Sleeves (No Suffix)
- Low Collector–Emitter Saturation Voltage
- High Current–Gain – Bandwidth Product
- Annular Construction for Low Leakage
- Epoxy Meets UL 94 V–0 @ 0.125 in
- NJV Prefix for Automotive and Other Applications Requiring Unique Site and Control Change Requirements; AEC–Q101 Qualified and PPAP Capable
- These Devices are Pb–Free and are RoHS Compliant

MAXIMUM RATINGS

Rating	Symbol	Max	Unit
Collector–Base Voltage	V_{CB}	40	Vdc
Collector–Emitter Voltage	V_{CEO}	25	Vdc
Emitter–Base Voltage	V_{EB}	8.0	Vdc
Collector Current – Continuous	I_C	5.0	Adc
Collector Current – Peak	I_{CM}	10	Adc
Base Current	I_B	1.0	Adc
Total Power Dissipation @ $T_C = 25^\circ\text{C}$ Derate above 25°C	P_D	12.5 0.1	W W/ $^\circ\text{C}$
Total Power Dissipation (Note 1) @ $T_A = 25^\circ\text{C}$ Derate above 25°C	P_D	1.4 0.011	W W/ $^\circ\text{C}$
Operating and Storage Junction Temperature Range	T_J, T_{stg}	–65 to +150	$^\circ\text{C}$
ESD – Human Body Model	HBM	3B	V
ESD – Machine Model	MM	C	V

Stresses exceeding those listed in the Maximum Ratings table may damage the device. If any of these limits are exceeded, device functionality should not be assumed, damage may occur and reliability may be affected.

1. These ratings are applicable when surface mounted on the minimum pad sizes recommended.

THERMAL CHARACTERISTICS

Characteristic	Symbol	Max	Unit
Thermal Resistance, Junction–to–Case	$R_{\theta JC}$	10	$^\circ\text{C}/\text{W}$
Thermal Resistance, Junction–to–Ambient (Note 2)	$R_{\theta JA}$	89.3	$^\circ\text{C}/\text{W}$

2. These ratings are applicable when surface mounted on the minimum pad sizes recommended.

SILICON POWER TRANSISTORS 5 AMPERES 25 VOLTS, 12.5 WATTS

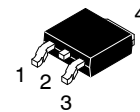
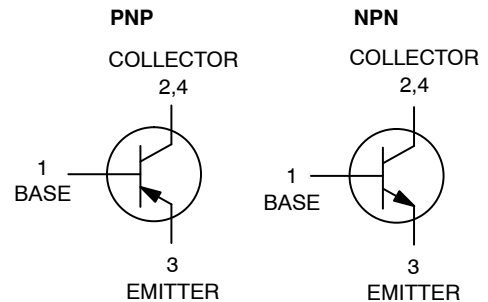

**DPAK
CASE 369C
STYLE 1**

MARKING DIAGRAM

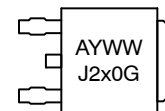

- A = Assembly Location
- Y = Year
- WW = Work Week
x = 1 or 0
- G = Pb–Free Package

ORDERING INFORMATION

See detailed ordering and shipping information in the package dimensions section on page 6 of this data sheet.

MJD200 (NPN), MJD210 (PNP)

ELECTRICAL CHARACTERISTICS ($T_C = 25^\circ\text{C}$ unless otherwise noted)

Characteristic	Symbol	Min	Max	Unit
OFF CHARACTERISTICS				
Collector-Emitter Sustaining Voltage (Note 3) ($I_C = 10\text{ mAdc}$, $I_B = 0$)	$V_{CE(sus)}$	25	-	Vdc
Collector Cutoff Current ($V_{CB} = 40\text{ Vdc}$, $I_E = 0$) ($V_{CB} = 40\text{ Vdc}$, $I_E = 0$, $T_J = 125^\circ\text{C}$)	I_{CBO}	-	100	nAdc μAdc
Emitter Cutoff Current ($V_{BE} = 8\text{ Vdc}$, $I_C = 0$)	I_{EBO}	-	100	nAdc
ON CHARACTERISTICS				
C Current Gain (Note 3), ($I_C = 500\text{ mAdc}$, $V_{CE} = 1\text{ Vdc}$) ($I_C = 2\text{ Adc}$, $V_{CE} = 1\text{ Vdc}$) ($I_C = 5\text{ Adc}$, $V_{CE} = 2\text{ Vdc}$)	h_{FE}	70 45 10	- 180 -	-
Collector-Emitter Saturation Voltage (Note 3) ($I_C = 500\text{ mAdc}$, $I_B = 50\text{ mAdc}$) ($I_C = 2\text{ Adc}$, $I_B = 200\text{ mAdc}$) ($I_C = 5\text{ Adc}$, $I_B = 1\text{ Adc}$)	$V_{CE(sat)}$	- - -	0.3 0.75 1.8	Vdc
Base-Emitter Saturation Voltage (Note 3) ($I_C = 5\text{ Adc}$, $I_B = 1\text{ Adc}$)	$V_{BE(sat)}$	-	2.5	Vdc
Base-Emitter On Voltage (Note 3) ($I_C = 2\text{ Adc}$, $V_{CE} = 1\text{ Vdc}$)	$V_{BE(on)}$	-	1.6	Vdc
DYNAMIC CHARACTERISTICS				
Current-Gain - Bandwidth Product (Note 4) ($I_C = 100\text{ mAdc}$, $V_{CE} = 10\text{ Vdc}$, $f_{test} = 10\text{ MHz}$)	f_T	65	-	MHz
Output Capacitance ($V_{CB} = 10\text{ Vdc}$, $I_E = 0$, $f = 0.1\text{ MHz}$) MJD200 MJD210, NJVMJD210T4G	C_{ob}	- -	80 120	pF

3. Pulse Test: Pulse Width = 300 μs , Duty Cycle $\approx 2\%$.

4. $f_T = |h_{fe}| \cdot f_{test}$.

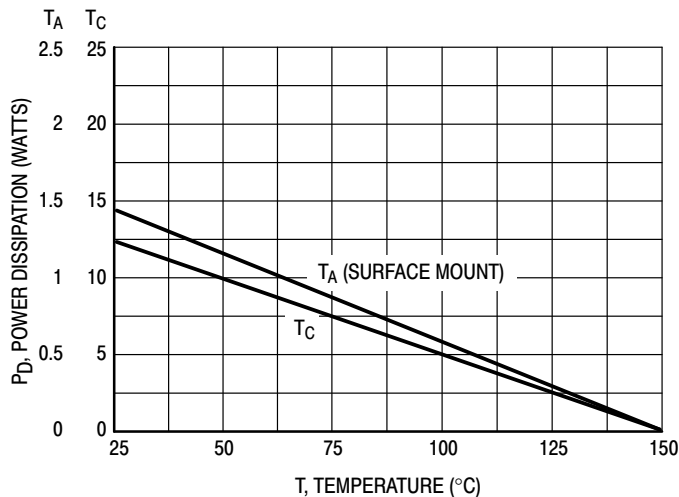

Figure 1. Power Derating

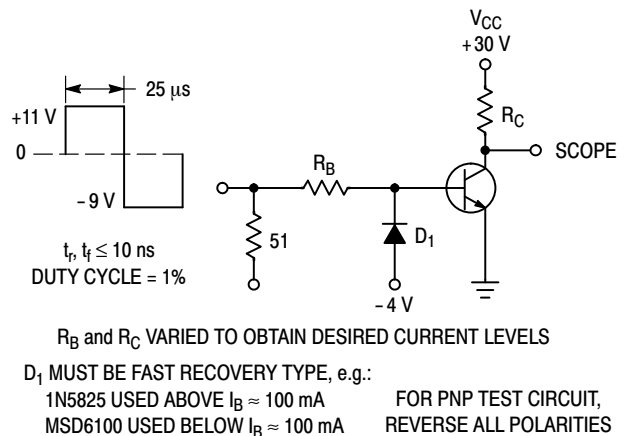

Figure 2. Switching Time Test Circuit

MJD200 (NPN), MJD210 (PNP)

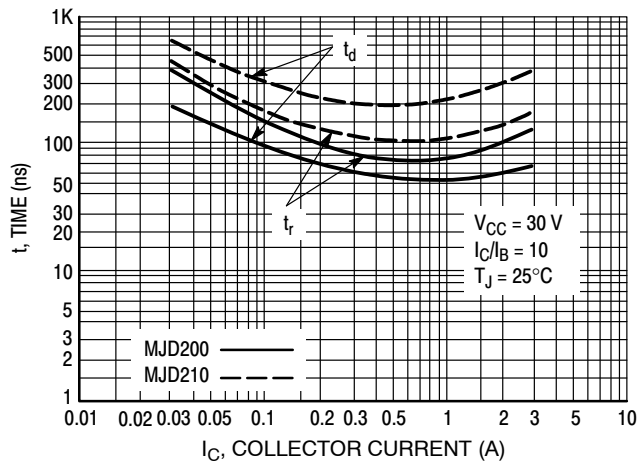

Figure 3. Turn-On Time

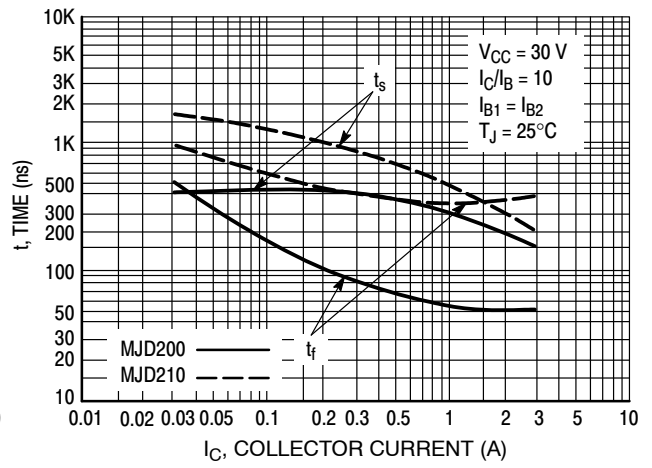

Figure 4. Turn-Off Time

MJD200 (NPN), MJD210 (PNP)

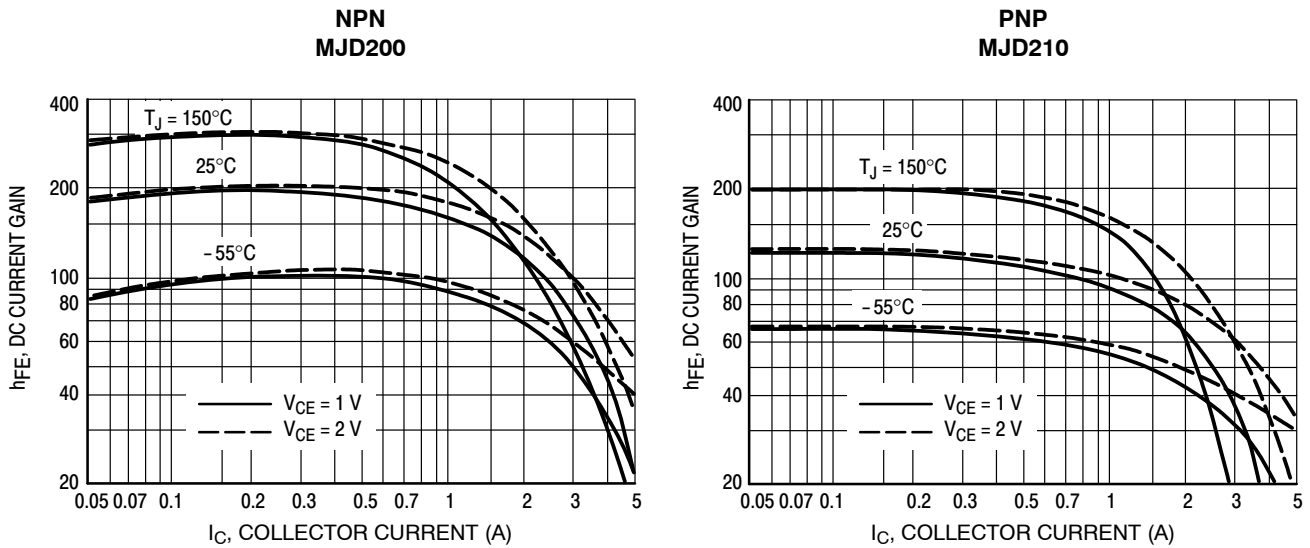

Figure 5. DC Current Gain

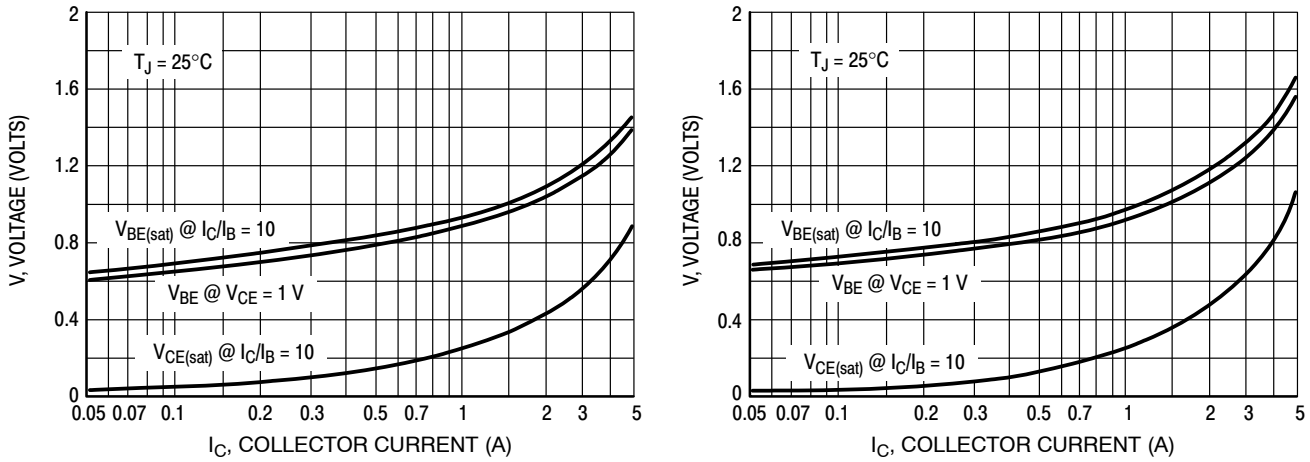

Figure 6. "On" Voltage

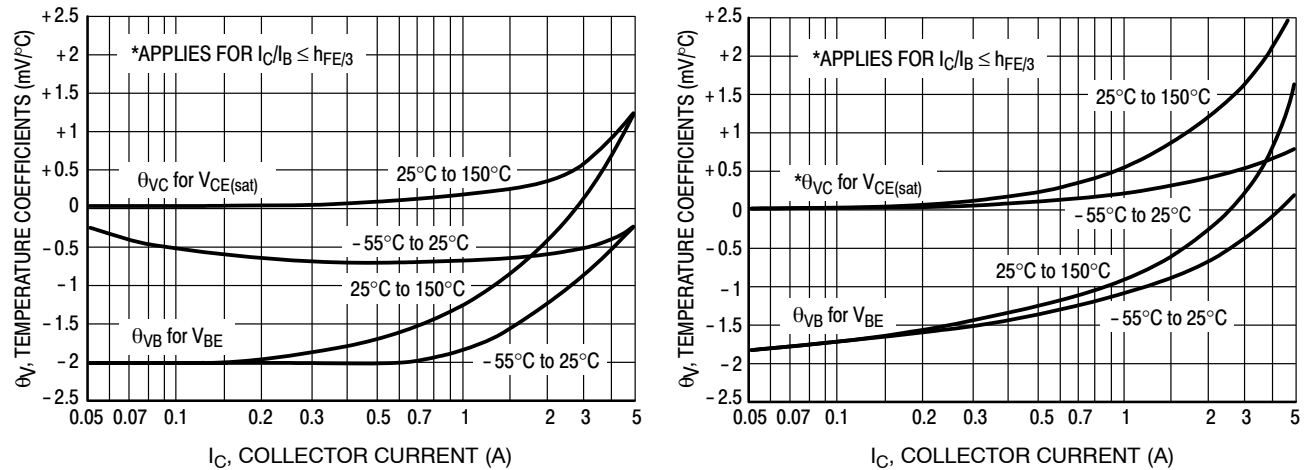

Figure 7. Temperature Coefficients

MJD200 (NPN), MJD210 (PNP)

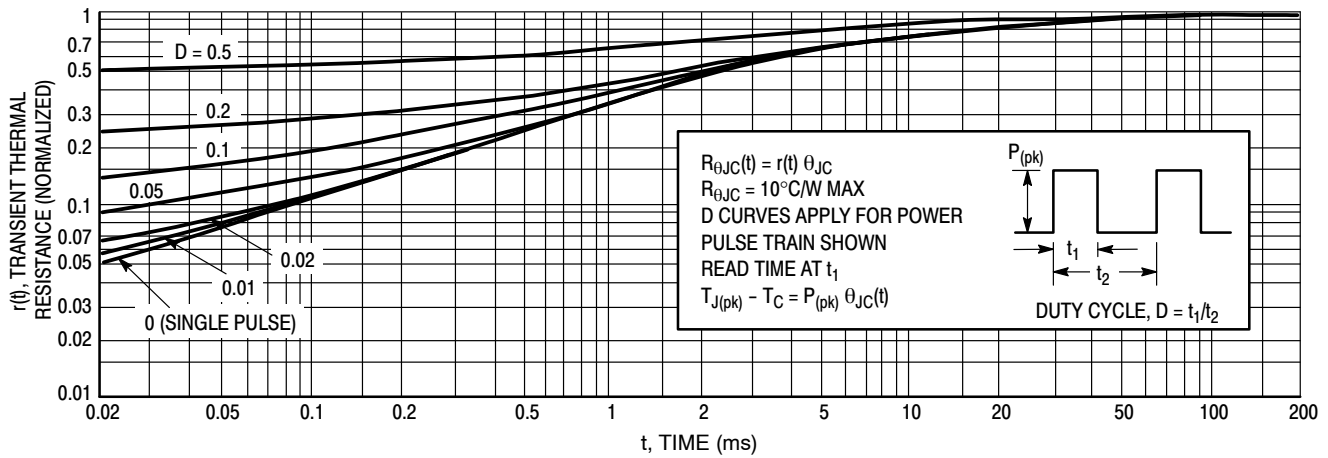

Figure 8. Thermal Response

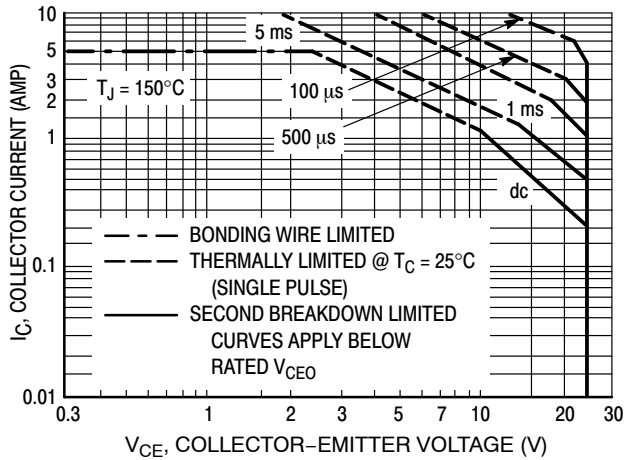

Figure 9. Active Region Safe Operating Area

There are two limitations on the power handling ability of a transistor: average junction temperature and second breakdown. Safe operating area curves indicate $I_C - V_{CE}$ limits of the transistor that must be observed for reliable operation; i.e., the transistor must not be subjected to greater dissipation than the curves indicate.

The data of Figure 9 is based on $T_{J(pk)} = 150^{\circ}\text{C}$; T_C is variable depending on conditions. Second breakdown pulse limits are valid for duty cycles to 10% provided $T_{J(pk)} \leq 150^{\circ}\text{C}$. $T_{J(pk)}$ may be calculated from the data in Figure 8. At high case temperatures, thermal limitations will reduce the power that can be handled to values less than the limitations imposed by second breakdown.

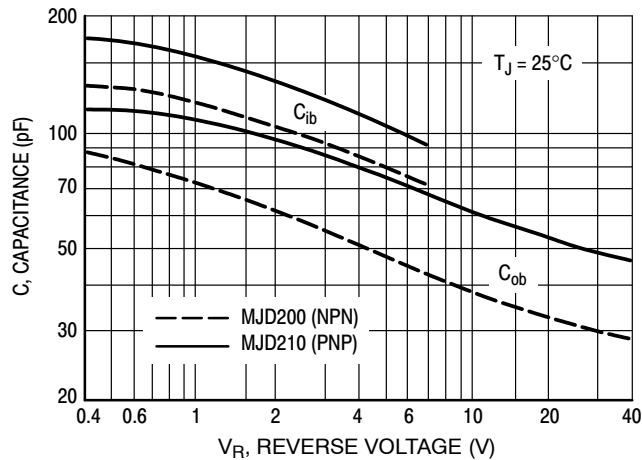

Figure 10. Capacitance

MJD200 (NPN), MJD210 (PNP)

ORDERING INFORMATION

Device	Package Type	Shipping†
MJD200G	DPAK (Pb-Free)	75 Units / Rail
MJD200RLG	DPAK (Pb-Free)	1,800 / Tape & Reel
MJD200T4G	DPAK (Pb-Free)	2,500 / Tape & Reel
MJD210G	DPAK (Pb-Free)	75 Units / Rail
MJD210RLG	DPAK (Pb-Free)	1,800 / Tape & Reel
MJD210T4G	DPAK (Pb-Free)	2,500 / Tape & Reel
NJVMJD210T4G*	DPAK (Pb-Free)	2,500 / Tape & Reel

†For information on tape and reel specifications, including part orientation and tape sizes, please refer to our Tape and Reel Packaging Specifications Brochure, BRD8011/D.

*NJV Prefix for Automotive and Other Applications Requiring Unique Site and Control Change Requirements; AEC-Q101 Qualified and PPAP Capable

MJD200 (NPN), MJD210 (PNP)

PACKAGE DIMENSIONS

DPAK CASE 369C ISSUE F

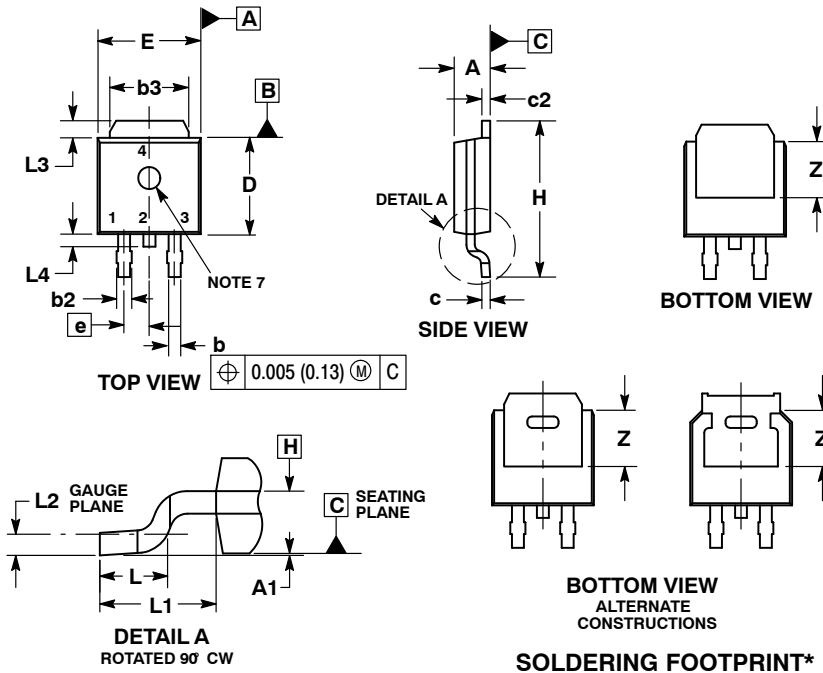

NOTES:

1. DIMENSIONING AND TOLERANCING PER ASME Y14.5M, 1994.
2. CONTROLLING DIMENSION: INCHES.
3. THERMAL PAD CONTOUR OPTIONAL WITHIN DIMENSIONS b3, L3 and Z.
4. DIMENSIONS D AND E DO NOT INCLUDE MOLD FLASH, PROTRUSIONS, OR BURRS. MOLD FLASH, PROTRUSIONS, OR GATE BURRS SHALL NOT EXCEED 0.006 INCHES PER SIDE.
5. DIMENSIONS D AND E ARE DETERMINED AT THE OUTERMOST EXTREMES OF THE PLASTIC BODY.
6. DATUMS A AND B ARE DETERMINED AT DATUM PLANE H.
7. OPTIONAL MOLD FEATURE.

DIM	INCHES		MILLIMETERS	
	MIN	MAX	MIN	MAX
A	0.086	0.094	2.18	2.38
A1	0.000	0.005	0.00	0.13
b	0.025	0.035	0.63	0.89
b2	0.028	0.045	0.72	1.14
b3	0.180	0.215	4.57	5.46
c	0.018	0.024	0.46	0.61
c2	0.018	0.024	0.46	0.61
D	0.235	0.245	5.97	6.22
E	0.250	0.265	6.35	6.73
e	0.090 BSC		2.29 BSC	
H	0.370	0.410	9.40	10.41
L	0.055	0.070	1.40	1.78
L1	0.114 REF		2.90 REF	
L2	0.020 BSC		0.51 BSC	
L3	0.035	0.050	0.89	1.27
L4	---	0.040	---	1.01
Z	0.155	---	3.93	---

SOLDERING FOOTPRINT*

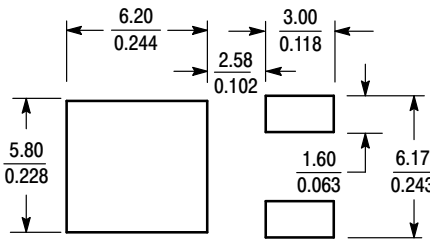

SCALE 3:1 $\left(\frac{\text{mm}}{\text{inches}} \right)$

STYLE 1:

1. BASE
2. COLLECTOR
3. EMITTER
4. COLLECTOR

*For additional information on our Pb-Free strategy and soldering details, please download the ON Semiconductor Soldering and Mounting Techniques Reference Manual, SOLDERRM/D.

ON Semiconductor and are trademarks of Semiconductor Components Industries, LLC dba ON Semiconductor or its subsidiaries in the United States and/or other countries. ON Semiconductor owns the rights to a number of patents, trademarks, copyrights, trade secrets, and other intellectual property. A listing of ON Semiconductor's product/patent coverage may be accessed at www.onsemi.com/site/pdf/Patent-Marking.pdf. ON Semiconductor reserves the right to make changes without further notice to any products herein. ON Semiconductor makes no warranty, representation or guarantee regarding the suitability of its products for any particular purpose, nor does ON Semiconductor assume any liability arising out of the application or use of any product or circuit, and specifically disclaims any and all liability, including without limitation special, consequential or incidental damages. Buyer is responsible for its products and applications using ON Semiconductor products, including compliance with all laws, regulations and safety requirements or standards, regardless of any support or applications information provided by ON Semiconductor. "Typical" parameters which may be provided in ON Semiconductor data sheets and/or specifications can and do vary in different applications and actual performance may vary over time. All operating parameters, including "Typicals" must be validated for each customer application by customer's technical experts. ON Semiconductor does not convey any license under its patent rights nor the rights of others. ON Semiconductor products are not designed, intended, or authorized for use as a critical component in life support systems or any FDA Class 3 medical devices or medical devices with a same or similar classification in a foreign jurisdiction or any devices intended for implantation in the human body. Should Buyer purchase or use ON Semiconductor products for any such unintended or unauthorized application, Buyer shall indemnify and hold ON Semiconductor and its officers, employees, subsidiaries, affiliates, and distributors harmless against all claims, costs, damages, and expenses, and reasonable attorney fees arising out of, directly or indirectly, any claim of personal injury or death associated with such unintended or unauthorized use, even if such claim alleges that ON Semiconductor was negligent regarding the design or manufacture of the part. ON Semiconductor is an Equal Opportunity/Affirmative Action Employer. This literature is subject to all applicable copyright laws and is not for resale in any manner.

PUBLICATION ORDERING INFORMATION

LITERATURE FULFILLMENT:

Literature Distribution Center for ON Semiconductor
 19521 E. 32nd Pkwy, Aurora, Colorado 80011 USA
Phone: 303-675-2175 or 800-344-3860 Toll Free USA/Canada
Fax: 303-675-2176 or 800-344-3867 Toll Free USA/Canada
Email: orderlit@onsemi.com

N. American Technical Support: 800-282-9855 Toll Free
 USA/Canada
Europe, Middle East and Africa Technical Support:
 Phone: 421 33 790 2910

ON Semiconductor Website: www.onsemi.com

Order Literature: <http://www.onsemi.com/orderlit>

For additional information, please contact your local Sales Representative



Стандарт Электрон Связь

Мы молодая и активно развивающаяся компания в области поставок электронных компонентов. Мы поставляем электронные компоненты отечественного и импортного производства напрямую от производителей и с крупнейших складов мира.

Благодаря сотрудничеству с мировыми поставщиками мы осуществляем комплексные и плановые поставки широчайшего спектра электронных компонентов.

Собственная эффективная логистика и склад в обеспечивает надежную поставку продукции в точно указанные сроки по всей России.

Мы осуществляем техническую поддержку нашим клиентам и предпродажную проверку качества продукции. На все поставляемые продукты мы предоставляем гарантию .

Осуществляем поставки продукции под контролем ВП МО РФ на предприятия военно-промышленного комплекса России , а также работаем в рамках 275 ФЗ с открытием отдельных счетов в уполномоченном банке. Система менеджмента качества компании соответствует требованиям ГОСТ ISO 9001.

Минимальные сроки поставки, гибкие цены, неограниченный ассортимент и индивидуальный подход к клиентам являются основой для выстраивания долгосрочного и эффективного сотрудничества с предприятиями радиоэлектронной промышленности, предприятиями ВПК и научно-исследовательскими институтами России.

С нами вы становитесь еще успешнее!

Наши контакты:

Телефон: +7 812 627 14 35

Электронная почта: sales@st-electron.ru

Адрес: 198099, Санкт-Петербург,
Промышленная ул, дом № 19, литера Н,
помещение 100-Н Офис 331