

F97-HT5 Series



High Temperature 150°C, Improved Reliability J-Lead



FEATURES

- Compliant to the RoHS2 directive 2011/65/EU
- Compliant to AEC-Q200
- Improved reliability - FR=0.5%/1000hrs (twice better than standard)
- SMD J-lead



APPLICATIONS

- Automotive electronics (Engine ECU, Transmission ECU, ISG, Head lamp)
- Industrial equipment

CASE DIMENSIONS: millimeters (inches)

Code	EIA Code	EIA Metric	L	W ₁	W ₂	H	S
A	1206	3216-18	3.20 ± 0.20 (0.126 ± 0.008)	1.60 ± 0.20 (0.063 ± 0.008)	1.20 ± 0.10 (0.047 ± 0.004)	1.60 ± 0.20 (0.063 ± 0.008)	0.80 ± 0.20 (0.031 ± 0.008)
B	1210	3528-21	3.50 ± 0.20 (0.126 ± 0.008)	2.80 ± 0.20 (0.110 ± 0.008)	2.20 ± 0.10 (0.087 ± 0.004)	1.90 ± 0.20 (0.075 ± 0.008)	0.80 ± 0.20 (0.031 ± 0.008)
C	2312	6032-27	6.00 ± 0.20 (0.236 ± 0.008)	3.20 ± 0.20 (0.126 ± 0.008)	2.20 ± 0.10 (0.087 ± 0.004)	2.50 ± 0.20 (0.098 ± 0.008)	1.30 ± 0.20 (0.051 ± 0.008)

A, B CASE

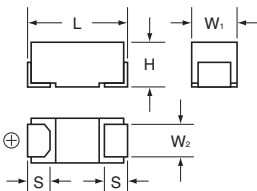

C CASE

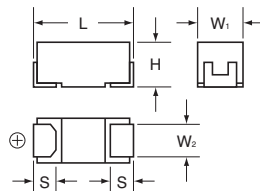

MARKING

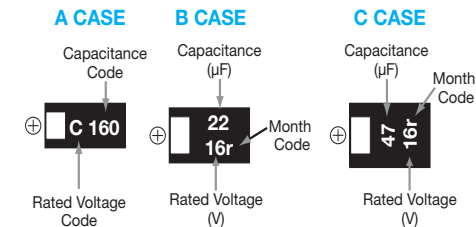

HOW TO ORDER

F97 Type	1C Rated Voltage	106 Capacitance Code pF code: 1st two digits represent significant figures, 3rd digit represents multiplier (number of zeros to follow)	M Tolerance K = ±10% M = ±20%	A Case Size See table above	 Packaging See Tape & Reel Packaging Section	HT5 Temperature Range 150°C MAX
--------------------	----------------------------	--	---	--	--	--

TECHNICAL SPECIFICATIONS

Category Temperature Range:	-55 to +150°C
Rated Temperature:	+105°C
Capacitance Tolerance:	±20%, ±10% at 120Hz
Dissipation Factor:	Refer to next page
ESR 100kHz:	Refer to next page
Leakage Current:	After 1 minute's application of rated voltage, leakage current at 20°C is not more than 0.01CV or 0.5µA, whichever is greater. After 1 minute's application of rated voltage, leakage current at 105°C is not more than 0.1CV or 5µA, whichever is greater. After 1 minute's application of derated voltage, leakage current at 150°C is not more than 0.125CV or 6.3µA, whichever is greater.
Capacitance Change By Temperature	+15% Max. at +150°C +10% Max. at +105°C -10% Max. at -55°C

F97-HT5 Series



High Temperature 150°C, Improved Reliability J-Lead

CAPACITANCE AND RATED VOLTAGE RANGE (LETTER DENOTES CASE SIZE)

Capacitance		Rated Voltage	
μF	Code	10V (1A)	16V (1C)
10	106		A
15	156	A	
22	226		B
33	336		
47	476		C

Released ratings

Please contact to your local AVX sales office when these series are being designed in your application.

RATINGS & PART NUMBER REFERENCE

AVX Part No.	Case Size	Capacitance (μF)	Rated Voltage (V)	Leakage Current (μA)	DF @ 120Hz (%)	ESR @ 100kHz (Ω)	ΔC/C (%)	MSL
10 Volt								
F971A156MAAHT5	A	15	10	1.5	10	3.0	*	3**
16 Volt								
F971C106MAAHT5	A	10	16	1.6	8	3.5	*	3**
F971C226MBAHT5	B	22	16	3.5	8	1.9	*	3**
F971C476MCCHT5	C	47	16	7.5	10	1.1	*	3**

* In case of capacitance tolerance ± 10% type, "K" will be put at 9th digit of type numbering system.

** Dry pack is recommended for reduction of stress during soldering but you can choose an option without dry pack.

Moisture Sensitivity Level (MSL) is defined according to J-STD-020.

QUALIFICATION TABLE

TEST	F97-HT5 series (Temperature range -55°C to +150°C)	
	Condition	
Damp Heat (Steady State)	At 85°C, 85% R.H., 1000 hours (No voltage applied) Capacitance Change Refer to page 117 (*1) Dissipation Factor Initial specified value or less Leakage Current 125% or less than the initial specified value	
Load Humidity	After 1000 hour's application of rated voltage in series with a 33Ω resistor at 85°C, 85% R.H., capacitors meet the characteristics requirements table below. Capacitance Change Refer to page 117 (*1) Dissipation Factor 120% or less than the initial specified value Leakage Current 200% of less than the initial specified value	
Temperature Cycles	At -55°C / +150°C, 30 minutes each, 1000 cycles Capacitance Change Refer to page 117 (*1) Dissipation Factor Initial specified value or less Leakage Current Initial specified value or less	
Resistance to Soldering Heat	10 seconds reflow at 260°C, 5 seconds immersion at 260°C. Capacitance Change Refer to page 117 (*1) Dissipation Factor Initial specified value or less Leakage Current Initial specified value or less	
Solderability	After immersing capacitors completely into a solder pot at 245°C for 2 to 3 seconds, more than 3/4 of their electrode area shall remain covered with new solder.	
Surge	After application of surge voltage in series with a 33Ω resistor at the rate of 30 seconds ON, 30 seconds OFF, for 1000 successive test cycles at 85°C, capacitors shall meet the characteristic requirements in the table above. Capacitance Change Refer to page 117 (*1) Dissipation Factor Initial specified value or less Leakage Current Initial specified value or less	
Endurance	After 2000 hours' application of rated voltage in series with a 3Ω resistor at 105°C, or derated voltage in series with a 3Ω resistor at 150°C, capacitors shall meet the characteristic requirements in the table above. Capacitance Change Refer to page 117 (*1) Dissipation Factor Initial specified value or less Leakage Current Initial specified value or less	
Shear Test	After applying the pressure load of 17.7N for 60 seconds horizontally to the center of capacitor side body which has no electrode and has been soldered beforehand on a substrate, there shall be found neither exfoliation nor its sign at the terminal electrode..	
Terminal Strength	Keeping a capacitor surface-mounted on a substrate upside down and supporting the substrate at both of the opposite bottom points 45mm apart from the center of capacitor, the pressure strength is applied with a specified jig at the center of the substrate so that substrate may bend by 1mm as illustrated. Then, there shall be found no remarkable abnormality on the capacitor terminals.	
Failure Rate	0.5% per 1000 hours at 105°C, V _R with 0.1Ω/V series impedance, 60% confidence level.	

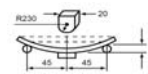

F97-HT5 Series



High Temperature 150°C, Improved Reliability J-Lead

AVX SOLID ELECTROLYTE CAPACITOR ROADMAP

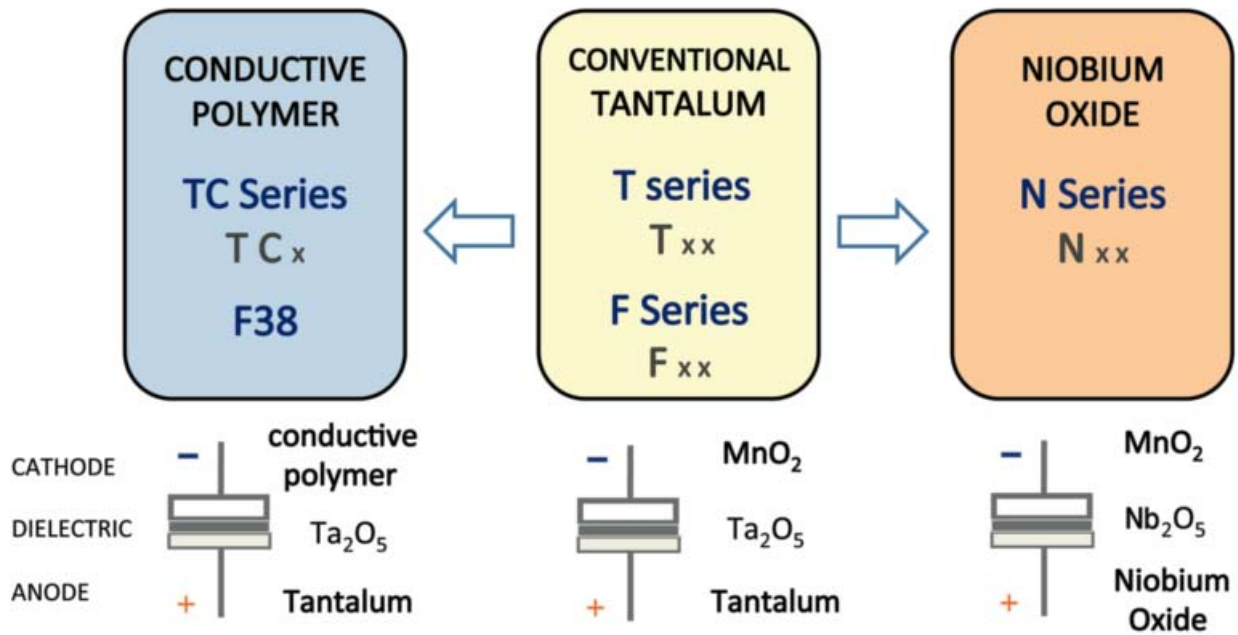

Five Capacitor Construction Styles

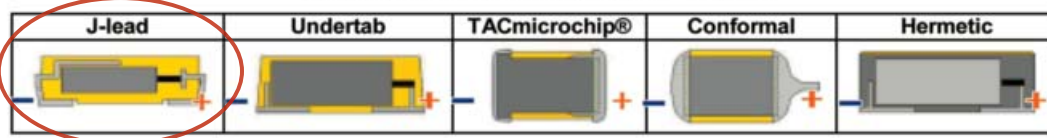

SERIES LINE UP: CONVENTIONAL SMD MnO₂

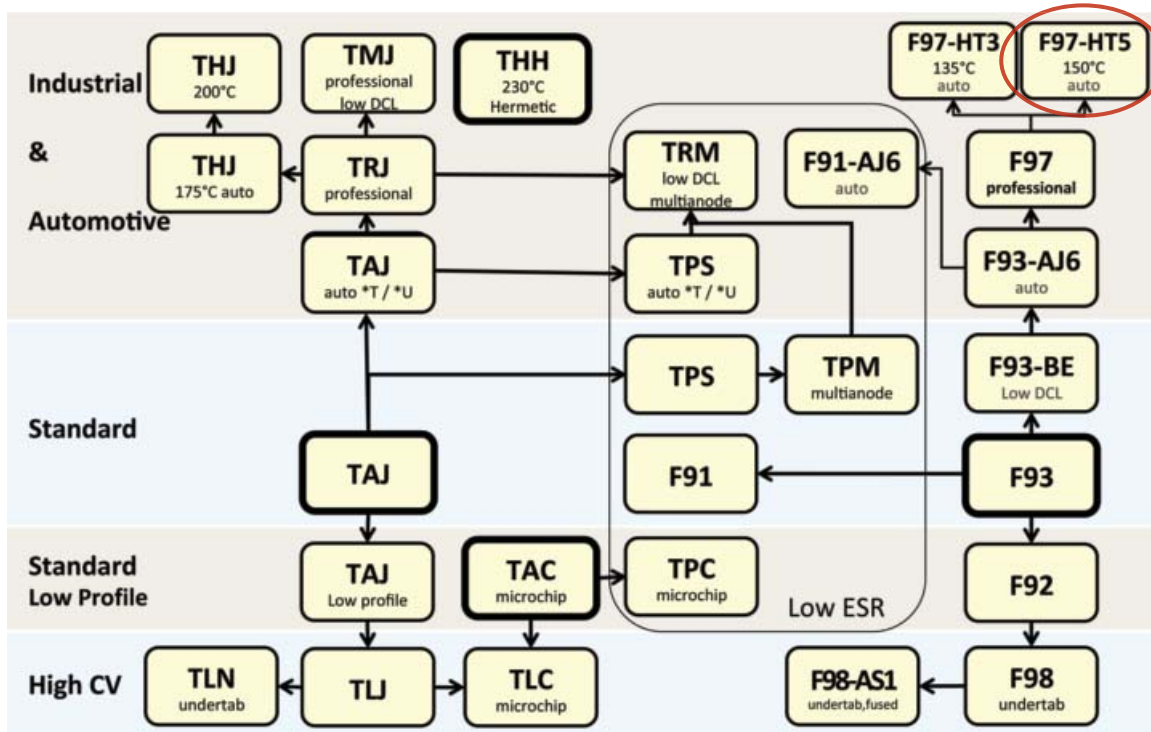



Стандарт Электрон Связь

Мы молодая и активно развивающаяся компания в области поставок электронных компонентов. Мы поставляем электронные компоненты отечественного и импортного производства напрямую от производителей и с крупнейших складов мира.

Благодаря сотрудничеству с мировыми поставщиками мы осуществляем комплексные и плановые поставки широчайшего спектра электронных компонентов.

Собственная эффективная логистика и склад в обеспечивает надежную поставку продукции в точно указанные сроки по всей России.

Мы осуществляем техническую поддержку нашим клиентам и предпродажную проверку качества продукции. На все поставляемые продукты мы предоставляем гарантию .

Осуществляем поставки продукции под контролем ВП МО РФ на предприятия военно-промышленного комплекса России , а также работаем в рамках 275 ФЗ с открытием отдельных счетов в уполномоченном банке. Система менеджмента качества компании соответствует требованиям ГОСТ ISO 9001.

Минимальные сроки поставки, гибкие цены, неограниченный ассортимент и индивидуальный подход к клиентам являются основой для выстраивания долгосрочного и эффективного сотрудничества с предприятиями радиоэлектронной промышленности, предприятиями ВПК и научно-исследовательскими институтами России.

С нами вы становитесь еще успешнее!

Наши контакты:

Телефон: +7 812 627 14 35

Электронная почта: sales@st-electron.ru

Адрес: 198099, Санкт-Петербург,
Промышленная ул, дом № 19, литера Н,
помещение 100-Н Офис 331