



## MIC2090/MIC2091

### Current Limiting Power Distribution Switches

### General Description

The MIC2090 and MIC2091 are high-side MOSFET power switches optimized for general-purpose 50mA or 100mA low power distribution in circuits requiring over-current limiting and circuit protection. Typical applications for these parts are for switching power in USB ports, portable consumer items, camera and camcorder motor protection, thermal printer head protection, and many other low current-load switching applications.

The MIC2090 and MIC2091 come in two versions: auto-retry current limit and output latch off on an over current fault. The MIC2090 and MIC2091 are offered in a space saving 5-pin SOT-23 package with an operating junction temperature range of  $-40^{\circ}\text{C}$  to  $+125^{\circ}\text{C}$ .

Data sheets and support documentation can be found on Micrel's web site at: [www.micrel.com](http://www.micrel.com).

### Features

- 1.8V to 5.5V supply voltage
- 790 m $\Omega$  typical  $R_{\text{DS(ON)}}$  at 3.3V
- MIC2090 is rated for 50mA minimum continuous current
- MIC2091 is rated for 100mA minimum continuous current
- Reverse current blocking (OGI)
- 20ns super fast reaction time to hard short at output
- 10ms fault flag delay ( $t_{\text{D\_FAULT}}$ ) eliminates false assertions
- Auto-retry overcurrent and short-circuit protection (-1 version)
- Latch-off on current limit (-2 version)
- Thermal shutdown
- Fault status flag indicates: over-current, over-temperature, or UVLO
- Under-voltage lockout (UVLO)
- Low quiescent current

### Applications

- USB peripherals
- Camcorder
- DSC
- MP3/iPod
- SD protection
- USB low-power hub

### Typical Application

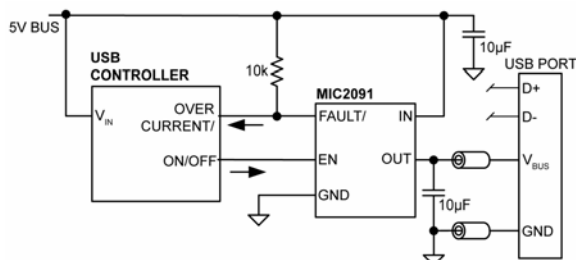

MIC2091 USB Power Switch

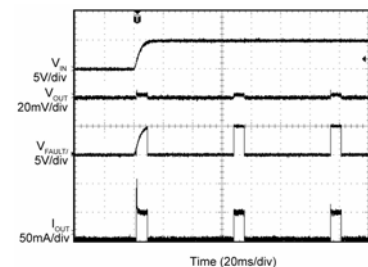

Startup into Short Circuit

## Ordering Information

Part Number	Marking	Current Limit	Current-Limit Recovery	Junction Temperature Range	Package
MIC2090-1YM5	<u>L</u> 1K	50mA	Auto-Retry	-40°C to +125°C	SOT-23-5
MIC2091-1YM5	<u>M</u> 1K	100mA	Auto-Retry	-40°C to +125°C	SOT-23-5
MIC2090-2YM5	<u>L</u> 2K	50mA	Latch-Off	-40°C to +125°C	SOT-23-5
MIC2091-2YM5	<u>M</u> 2K	100mA	Latch-Off	-40°C to +125°C	SOT-23-5

## Pin Configuration

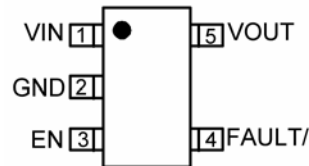

5-Pin SOT-23 (M5)

## Pin Description

Pin Number	Pin Name	Pin Function
1	VIN	Supply (Input): +1.8V to +5.5V. Provides power to the output switch and the MIC2090/MIC2091 internal control circuitry.
2	GND	Ground.
3	EN	Enable (Input): Active-high TTL compatible control input. A high signal turns on the internal switch and supplies power to the load. This pin cannot be left floating.
4	FAULT/	Fault Status (Output): Open drain output. Can be connected to other open drain outputs. Must be pulled high with an external resistor. When EN=0, FAULT/ pin is high When EN=1, a low on the FAULT/ pin indicates one or more of the following conditions: 1. The part is in current limit and is turned off. 2. The part is in thermal limit and is turned off. 3. The part is in UVLO
5	VOUT	Switched Output (Output): The voltage on this pin is controlled by the internal switch. Connect the load driven by the MIC2090/MIC2091 to this pin.

**Absolute Maximum Ratings<sup>(1)</sup>**

Supply Voltage ( $V_{IN}$ )	-0.3V to +6.0V
Output Voltage ( $V_{OUT}$ )	-0.3V to +6.0V
FAULT/ Pin Voltage ( $V_{FAULT/}$ )	-0.3V to +6.0V
FAULT/ Pin Current ( $I_{FAULT/}$ )	25mA
EN Pin Voltage ( $V_{EN}$ )	-0.3V to ( $V_{IN} + 0.3V$ )
Power Dissipation ( $P_D$ )	Internally Limited
Maximum Junction Temperature ( $T_J$ )	150°C
Storage Temperature ( $T_S$ )	-65°C to +150°C
Lead Temperature (soldering, 10s)	260°C
ESD HBM Rating <sup>(3)</sup>	3kV
ESD MM Rating <sup>(3)</sup>	200V

**Operating Ratings<sup>(2)</sup>**

Supply Voltage ( $V_{IN}$ )	+1.8V to +5.5V
Output Voltage ( $V_{OUT}$ )	+1.8V to +5.5V
EN Pin Voltage ( $V_{EN}$ )	0V to $V_{IN}$
FAULT/ Pin Voltage ( $V_{FAULT/}$ )	0V to 5.5V
FAULT/ Pin Current ( $I_{FAULT/}$ )	1mA
Ambient Temperature ( $T_A$ )	-40°C to +85°C
Junction Temperature ( $T_J$ )	-40°C to +125°C
Package Thermal Resistance	
SOT23-5 ( $\theta_{JA}$ )	252.7°C/W

**Electrical Characteristics<sup>(4)</sup>**

$V_{IN} = 5V$ ;  $T_A = 25^\circ C$ , **bold** values indicate  $-40^\circ C \leq T_A \leq +85^\circ C$ , unless noted.

Symbol	Parameter	Condition	Min.	Typ.	Max.	Units
<b>Power Input Supply</b>						
$V_{IN}$	Input Voltage Range		<b>1.8</b>		<b>5.5</b>	V
$I_{VIN}$	Shutdown Current	$V_{EN} \leq 0.5V$ (switch off), $V_{OUT} = \text{open}$		5	<b>10</b>	$\mu A$
	Supply Current	$V_{EN} \geq 1.5V$ (switch on), $V_{OUT} = \text{open}$		70	<b>110</b>	
$V_{UVLO}$	Under-Voltage Lockout Threshold	$V_{IN}$ rising			<b>1.75</b>	V
$V_{UVLO\_HYS}$	Under-Voltage Lockout Threshold Hysteresis			100		mV
<b>Enable Input</b>						
$V_{EN}$	Enable Logic Level High <sup>(5)</sup>	$V_{IH(MIN)}$	<b>1.5</b>			V
	Enable Logic Level Low <sup>(5)</sup>	$V_{IL(MAX)}$			<b>0.5</b>	
$I_{EN}$	Enable Bias Current	$V_{EN} = 5V$		0.1		$\mu A$
$t_{ON}$	Output Turn-On Delay	$R_L = 500\Omega$ , $C_L = 0.1\mu F$ See "Timing Diagrams"		215		$\mu s$
$t_R$	Output Turn-On Rise Time	$R_L = 500\Omega$ , $C_L = 0.1\mu F$ See "Timing Diagrams"		5		$\mu s$
$t_{OFF}$	Output Turn-Off Delay	$R_L = 500\Omega$ , $C_L = 0.1\mu F$ See "Timing Diagrams"		125		$\mu s$
$t_F$	Output Turn-Off Fall Time	$R_L = 500\Omega$ , $C_L = 0.1\mu F$ See "Timing Diagrams"		115		$\mu s$
<b>Internal Switch</b>						
$R_{DS(ON)}$	On Resistance $R_{DS(ON)}$	MIC2090 $V_{IN} = 5.0V$ , $I_{OUT} = 50mA$		700	<b>1200</b>	m $\Omega$
		MIC2090 $V_{IN} = 3.3V$ , $I_{OUT} = 50mA$		790	<b>1200</b>	
		MIC2090 $V_{IN} = 1.8V$ , $I_{OUT} = 50mA$		1300		
		MIC2091 $V_{IN} = 5.0V$ , $I_{OUT} = 100mA$		700	<b>1200</b>	
		MIC2091 $V_{IN} = 3.3V$ , $I_{OUT} = 100mA$		790	<b>1200</b>	
		MIC2091 $V_{IN} = 1.8V$ , $I_{OUT} = 100mA$		1300		
	Input-to-Output Leakage Current (Forward leakage Current)	MIC2090 and MIC2091, $V_{EN} \leq 0.5V$ , (output off), $V_{IN} = 5.5V$ , $V_{OUT} = 0V$			<b>10</b>	$\mu A$

**Electrical Characteristics<sup>(4)</sup> (Continued)**

$V_{IN} = 5V$ ;  $T_A = 25^\circ C$ , **bold** values indicate  $-40^\circ C \leq T_A \leq +85^\circ C$ , unless noted.

Symbol	Parameter	Condition	Min.	Typ.	Max.	Units
	Output to Input Leakage Current (Reverse Leakage Current)	MIC2090 and MIC2091, $V_{EN} \leq 0.5V$ , (output off), $V_{OUT} = 5.5V$ , $V_{IN} = 0V$			<b>10</b>	$\mu A$
<b>Current Limit</b>						
$I_{LIMIT}$	Current-Limit Threshold	MIC2090 @ $V_{OUT} = 4.5V$	<b>50</b>	75	<b>100</b>	mA
		MIC2090 @ $V_{OUT} = 0V$	<b>50</b>	100	<b>150</b>	
		MIC2091 @ $V_{OUT} = 4.5V$	<b>100</b>	150	<b>200</b>	
		MIC2091 @ $V_{OUT} = 0V$	<b>100</b>	175	<b>250</b>	
$t_{SC\_RESP}$	Short-Circuit Response Time	Short circuit applied to output after switch is turned on, see "Timing Diagrams". $V_{IN} = 3.3V$ .		20		ns
$T_{AUTORESTART}$	Time After Switch Shuts Down From An Over-Current Condition Before It Tries To Turn On Again.		<b>30</b>	60	<b>90</b>	ms
<b>FAULT/ Flag</b>						
	Error Flag Output Voltage	Output voltage high (1mA Sinking)			<b>0.4</b>	V
$t_{D\_FAULT/}$	Time After Switch Comes Into Current Limit Before The PIN FAULT/ Is Pulled Low.	When an over-current condition happens, the part will go into constant output current for this time. After this time it will turn off the output and pull low the PIN FAULT/. The MIC2090-1 and MIC2091-1 will automatically restart themselves after the auto restart time $T_{AUTORESTART}$ .	<b>5</b>	10	<b>20</b>	ms
$t_{R\_FAULT/}$	FAULT/ Rising Time	FAULT/ is connected to $V_{IN} = 5V$ through 10k $\Omega$ and 100pF in parallel. See "Timing Diagrams"		5		$\mu s$
$t_{F\_FAULT/}$	FAULT/ Falling Time			1		$\mu s$
<b>Reverse Voltage Protection (OGI)</b>						
OGI	Output Voltage Greater Than Input Voltage (OGI)	If the output voltage is greater than the input voltage by this amount, the part will shut down. The enable pin must be recycled to reset.		85		mV
OGI <sub>TIME</sub>		Time that the output voltage can be greater than the input voltage before the chip is shut down.		10		ms
<b>Thermal Protection</b>						
$T_{OVERTEMP}$	Over-Temperature Shutdown	$T_J$ Rising		150		$^\circ C$
		$T_J$ Falling		140		

**Notes:**

- Exceeding the absolute maximum rating may damage the device.
- The device is not guaranteed to function outside its operating rating.
- Devices are ESD sensitive. Handling precautions recommended. Human body model, 1.5k in series with 100pF.
- Specification for packaged product only.
- $V_{IL(MAX)}$  = Maximum positive voltage applied to the input which will be accepted by the device as a logic low.  
 $V_{IH(MIN)}$  = Minimum positive voltage applied to the input which will be accepted by the device as a logic high.

## Timing Diagrams

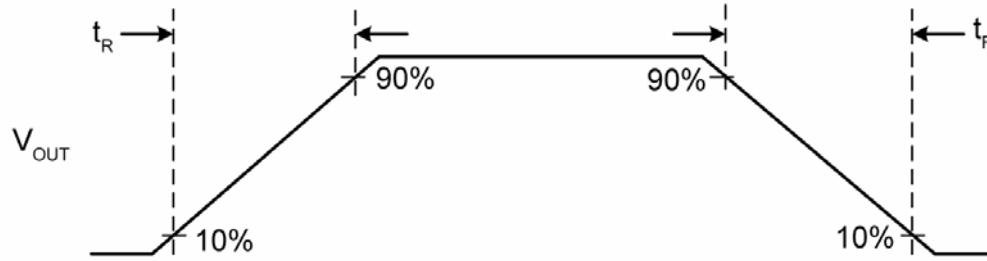

Output Rise and Fall Times ( $t_R$ ,  $t_F$ )

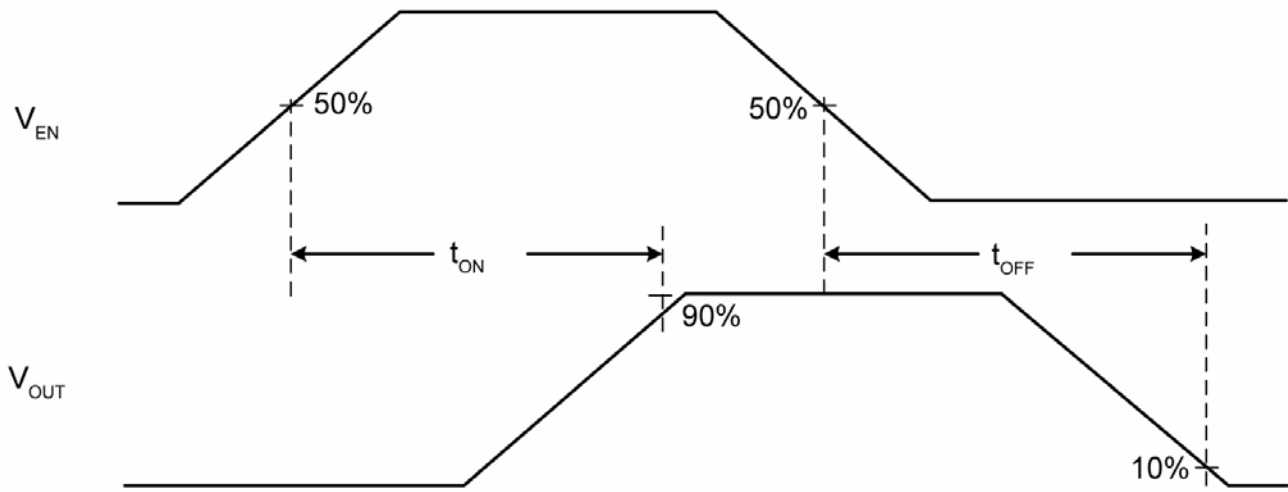

Switch Delay Time ( $t_{ON}$ ,  $t_{OFF}$ )

# Typical Characteristics

**VIN Shutdown Current vs. Input Voltage**

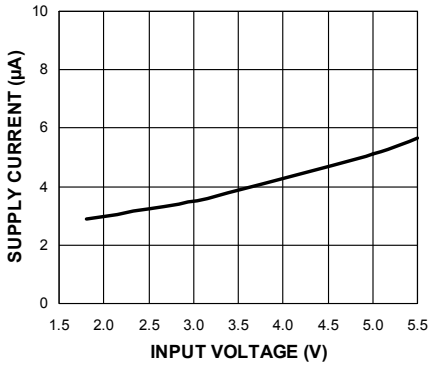

**VIN Supply Current vs. Input Voltage**

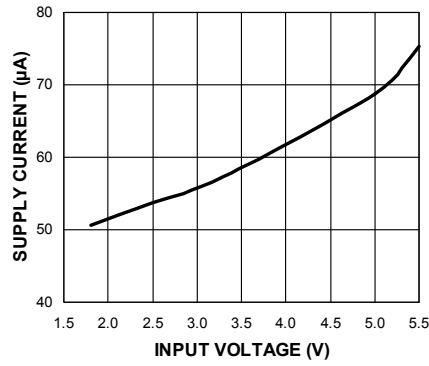

**Enable Thresholds vs. Input Voltage**

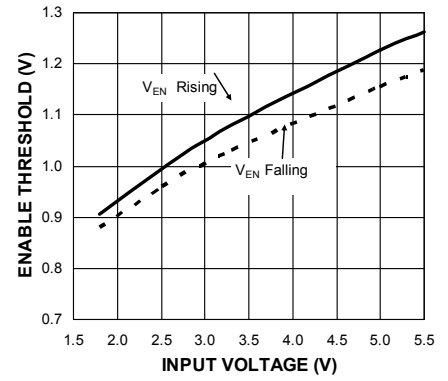

**Current Limit vs. Input Voltage  
MIC2090**

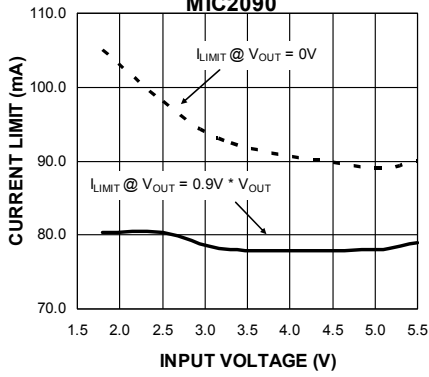

**FAULT/ Delay vs. Input Voltage  
(MIC2090)**

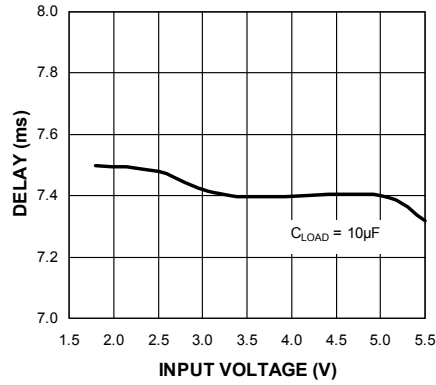

**Auto-Reset Time vs. Input Voltage  
(MIC2090)**

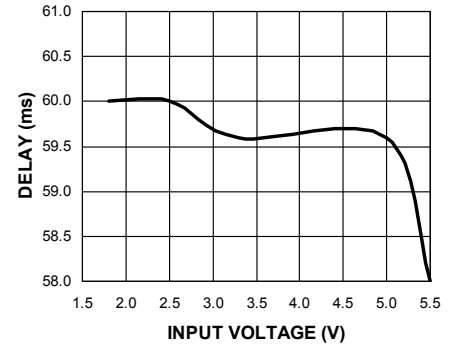

**Current Limit vs. Input Voltage  
MIC2091**

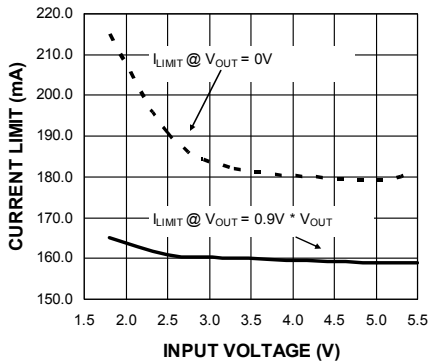

**Switch On Resistance vs. Input Voltage**

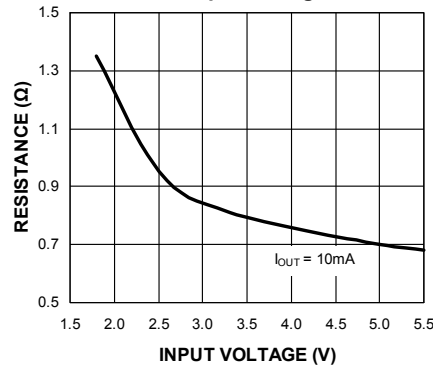

**Output Turn-On Delay vs. Input Voltage**

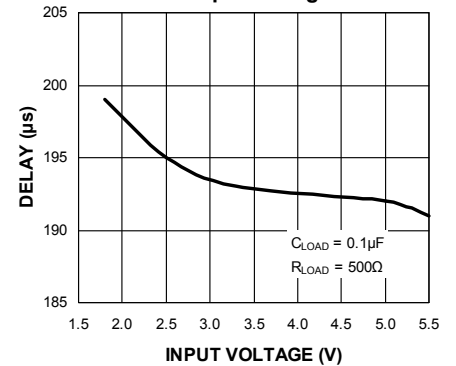

## Typical Characteristics (Continued)

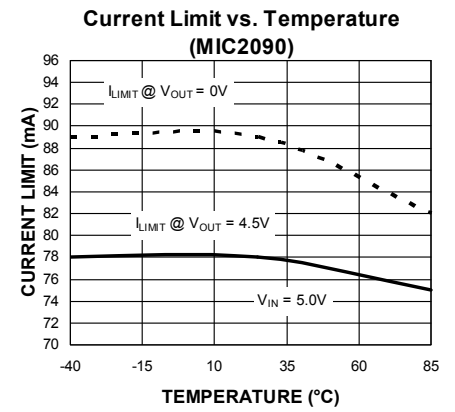
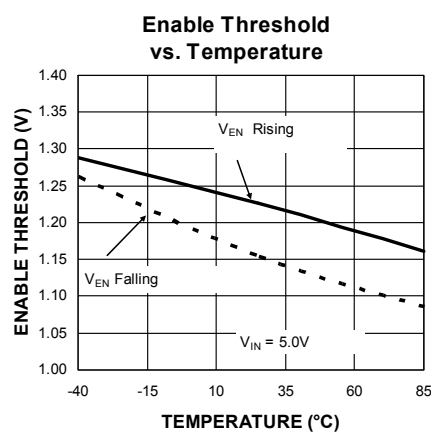
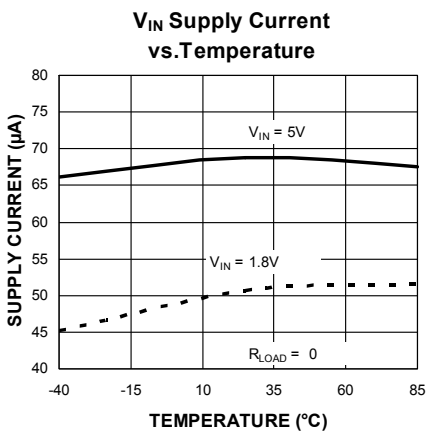
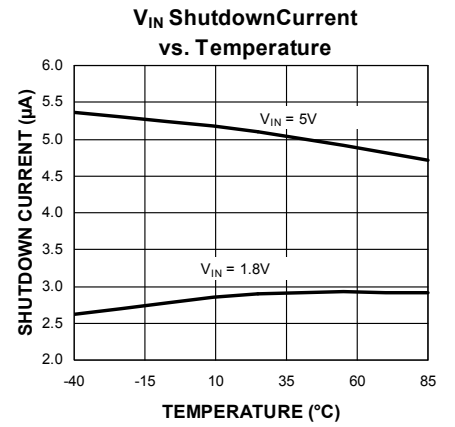
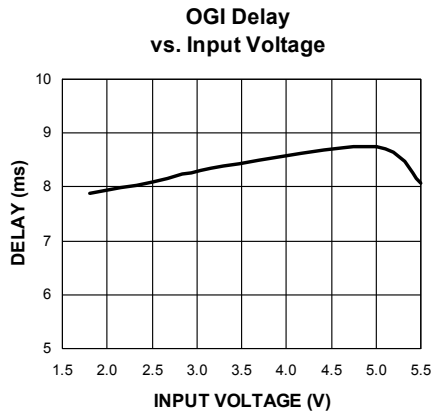
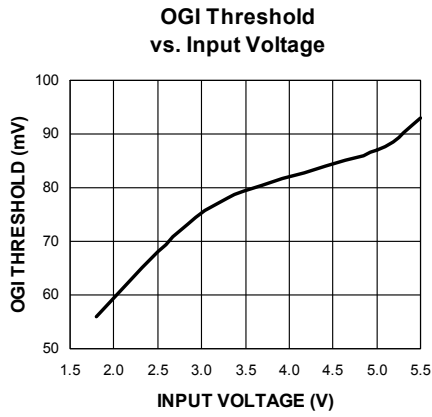
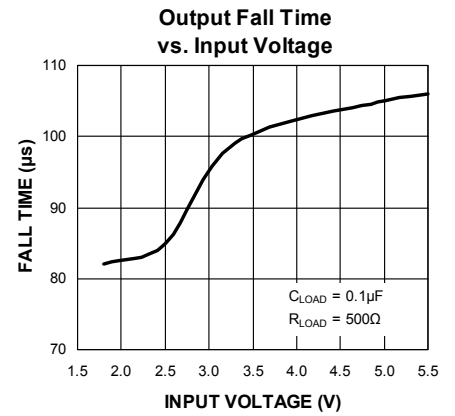
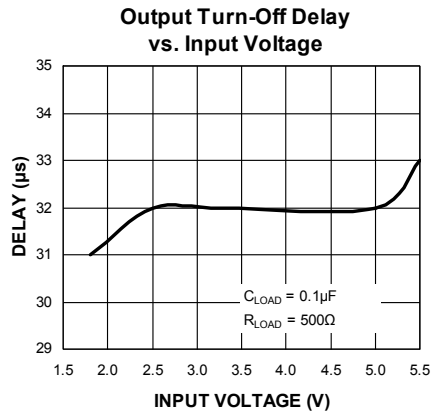
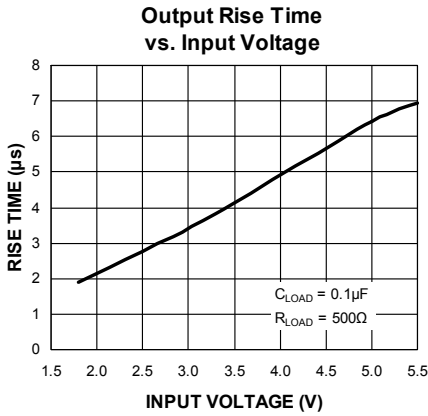

## Typical Characteristics (Continued)

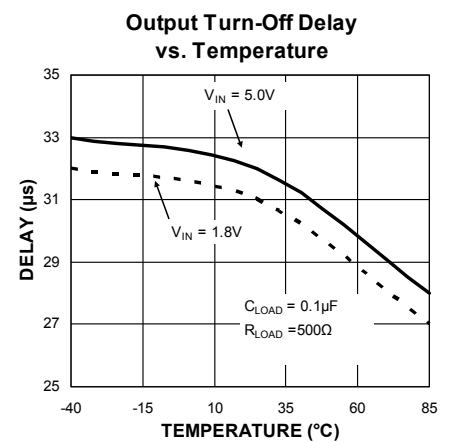
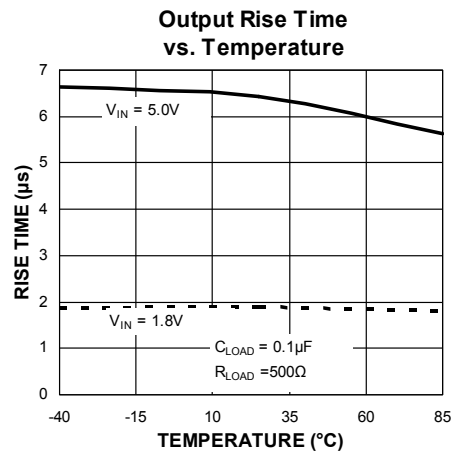
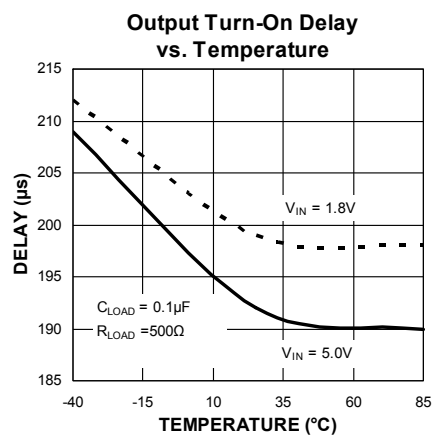
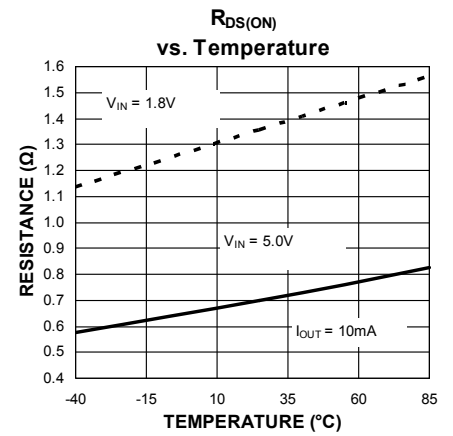
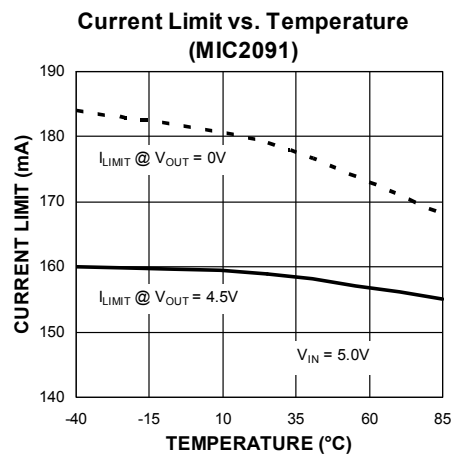
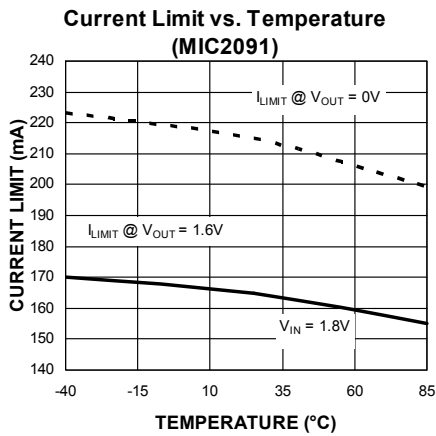
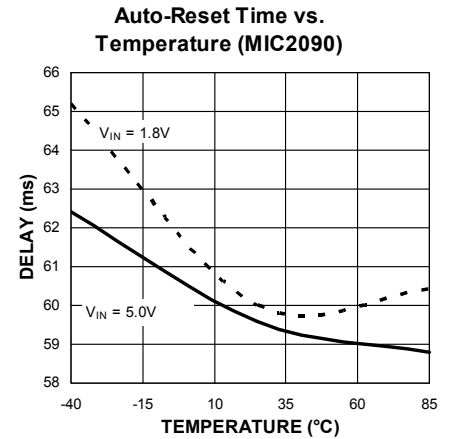
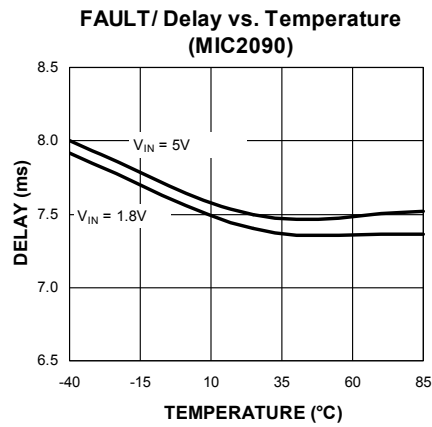
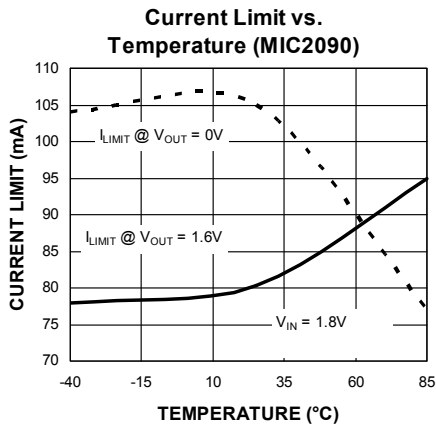



## Typical Characteristics (Continued)

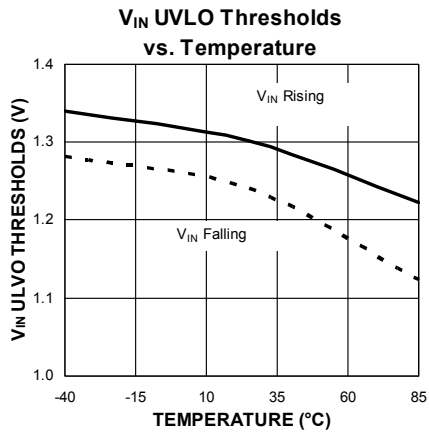
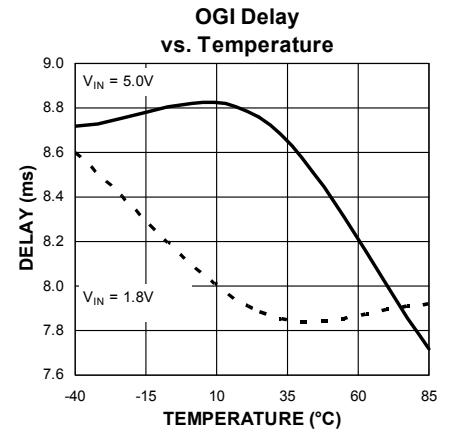
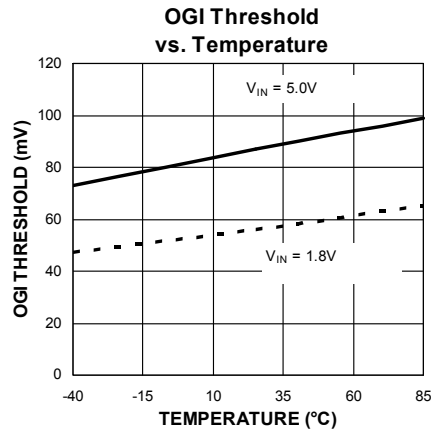
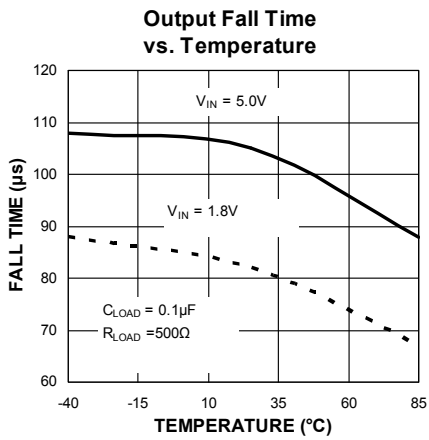

### Functional Characteristics

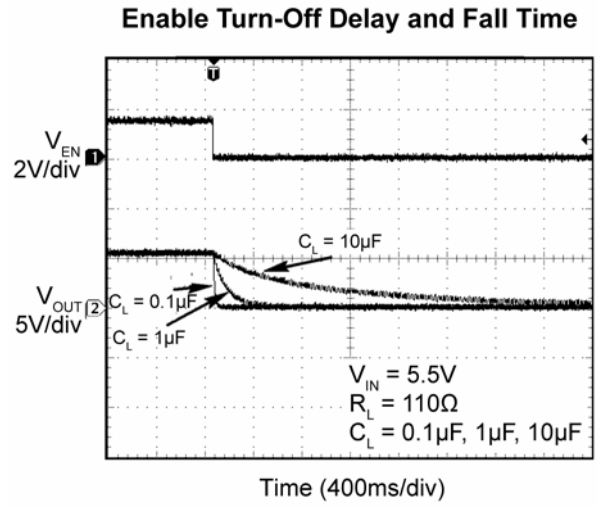
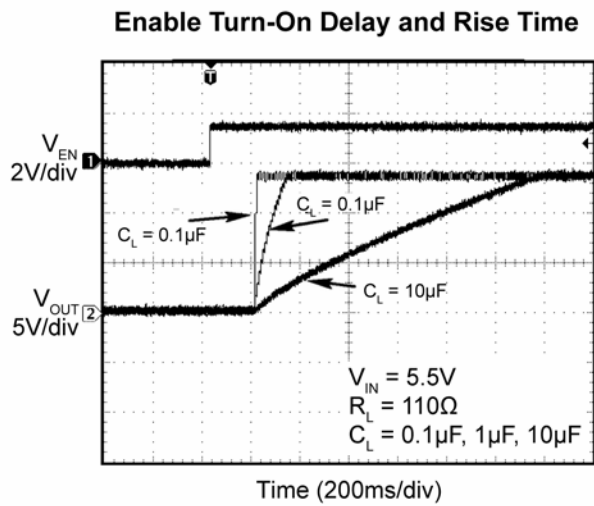
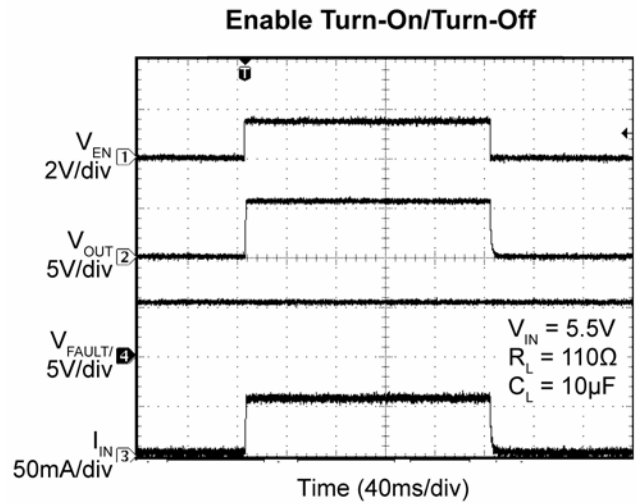
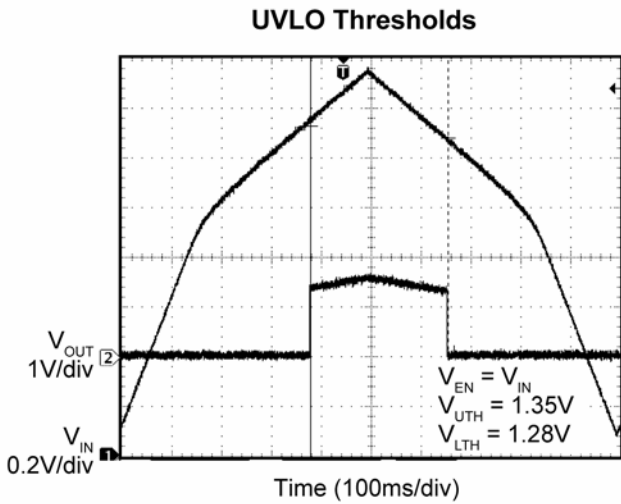
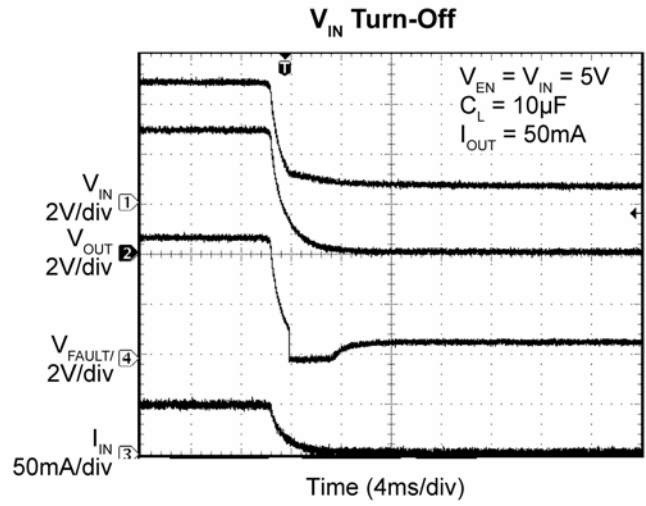
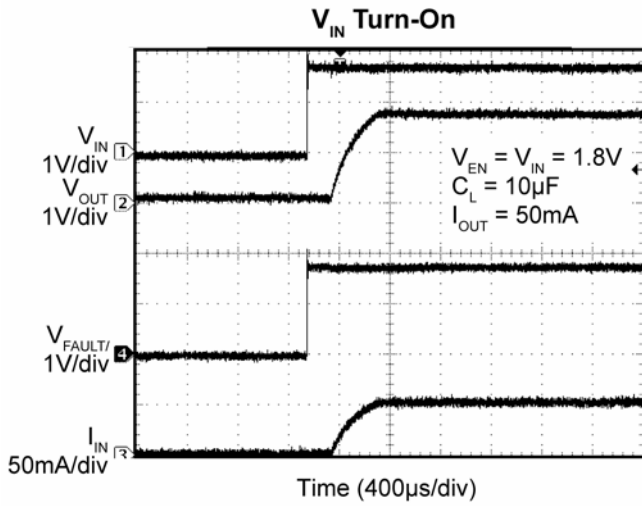

## Functional Characteristics (Continued)

**Current-Limit Response, Enabled into Short**

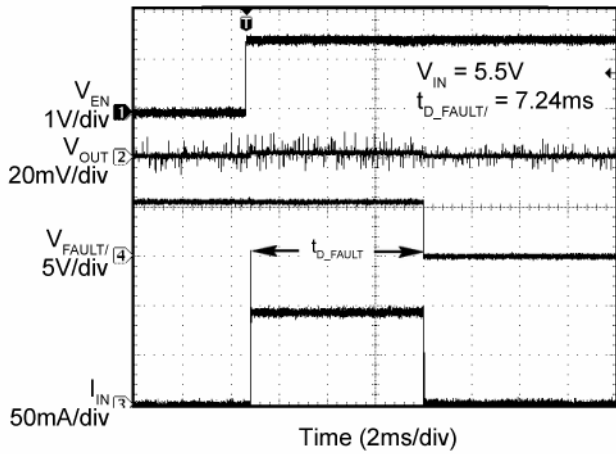

**Power-Up into Short Circuit (-1 Version)**

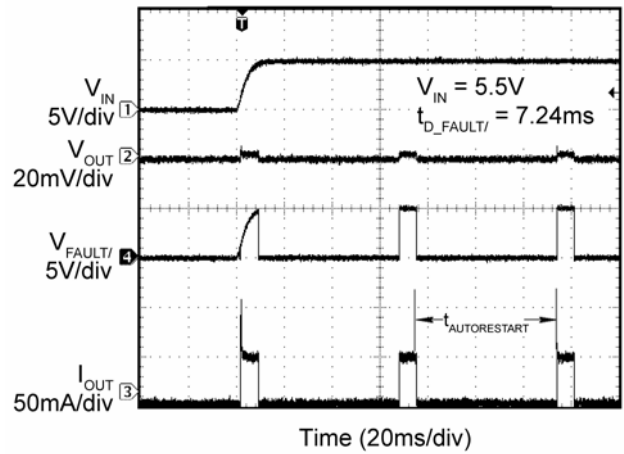

**Current-Limit Response, Stepped Short**

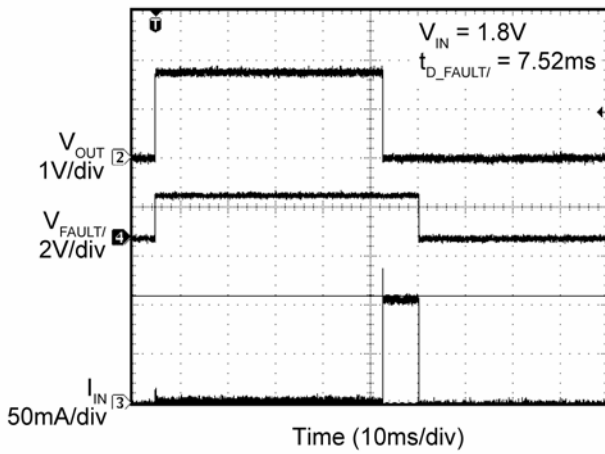

**Current-Limit Response, Stepped Overcurrent**

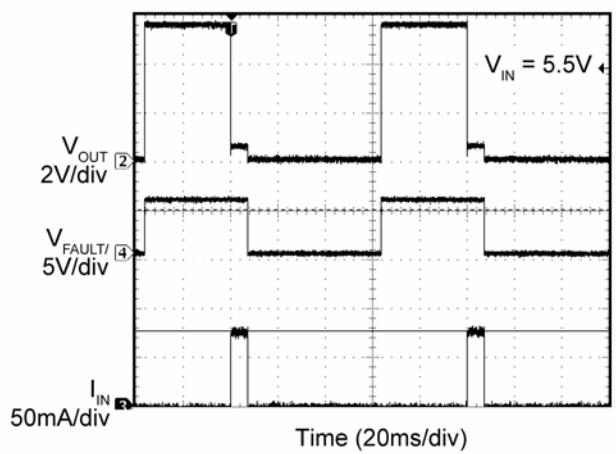

**Output Recovery from Short Circuit and FAULT/ Response (-1 Version)**

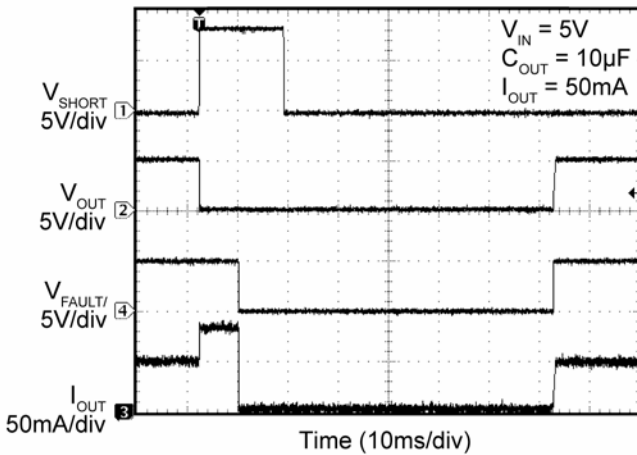

**Output Recovery from Thermal Shutdown and FAULT/ Response**

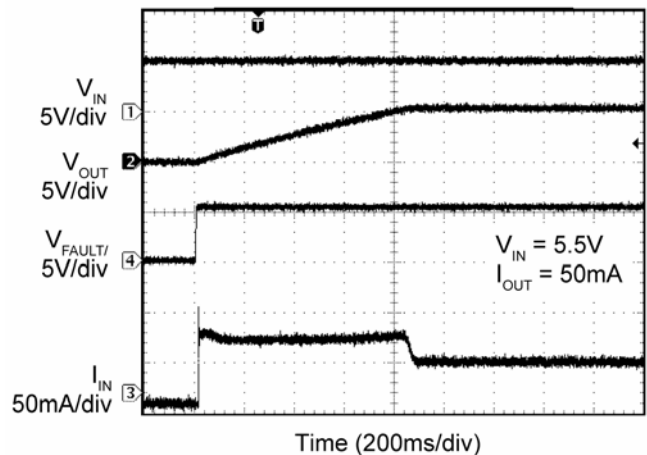

Functional Characteristics (Continued)

$I_{OUT}$  Current Limiting for  $V_{OUT} < 1.8V$  (-1 Version)

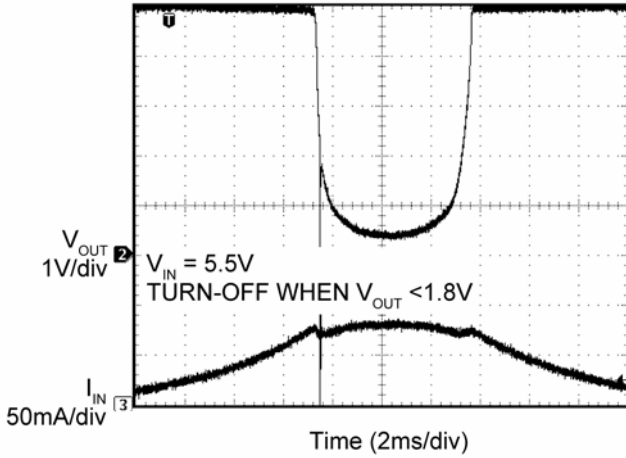

$I_{OUT}$  Current Limiting for  $V_{OUT} > 1.8V$  (-1 Version)

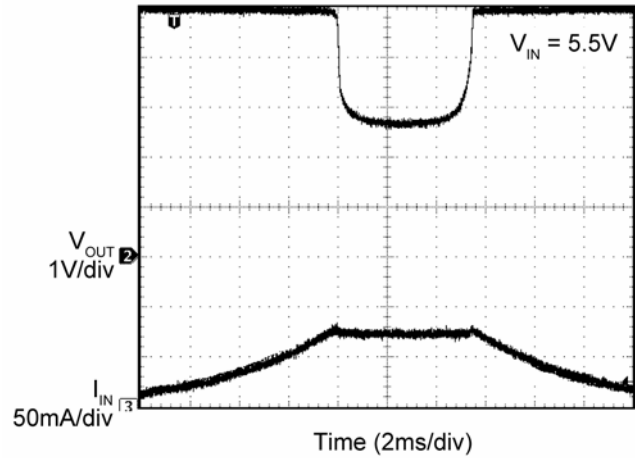

Inrush Current Response

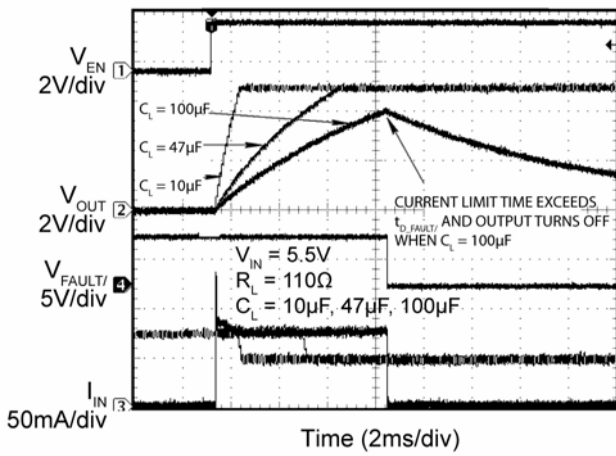

$V_{OUT} < V_{IN}$ , Enable into Pre-Biased Output

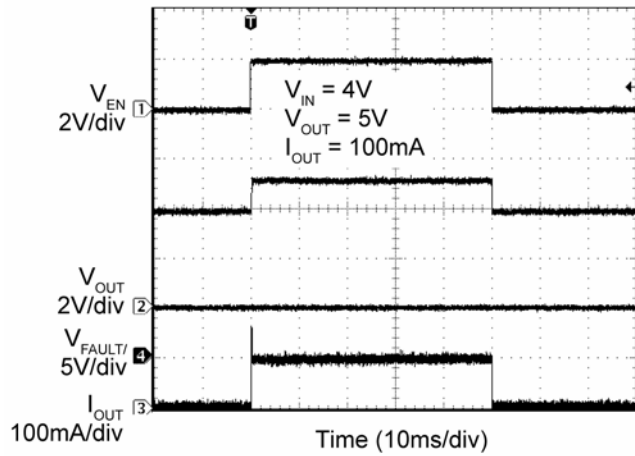

$V_{OUT} > V_{IN}$ , Enable into Pre-Biased Output

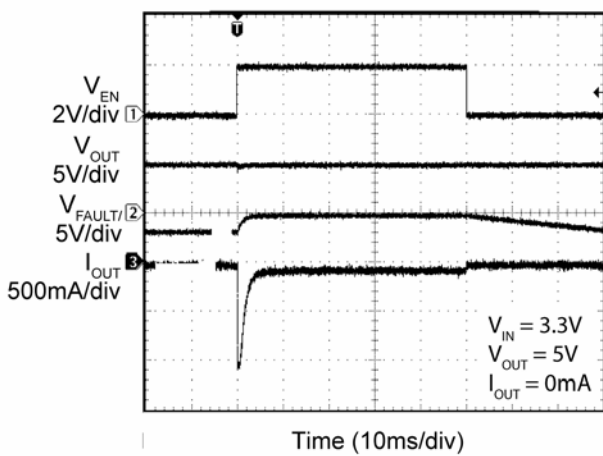

$V_{OUT} > V_{IN}$ ,  $V_{IN}$  Turn-On into Pre-Biased Output

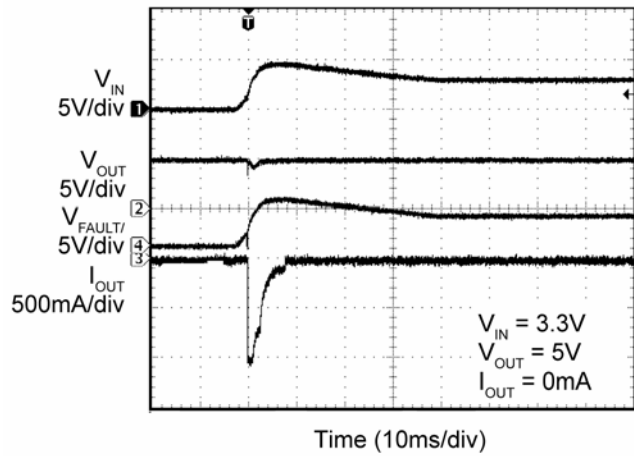

### Functional Characteristics (Continued)

Increase  $V_{OUT}$  Above  $V_{IN}$  While Running

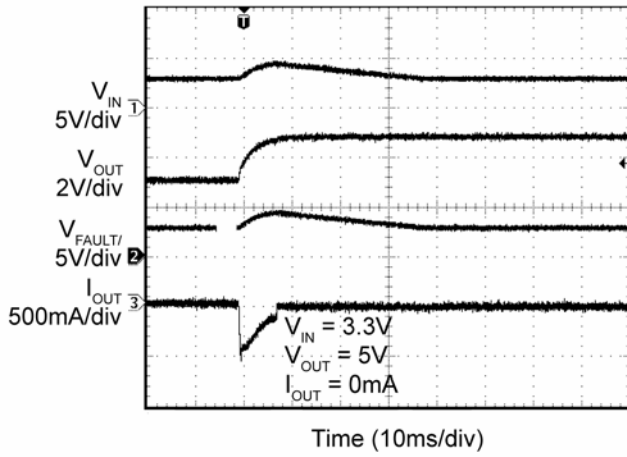

Overcurrent Latch-Off and Recovery (-2 Version)

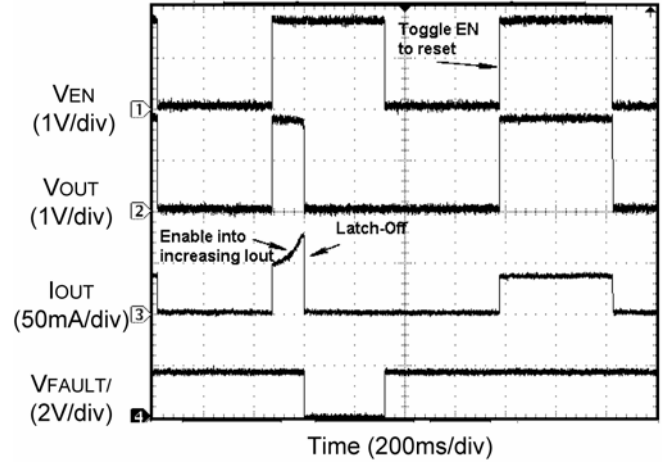

### Functional Diagram

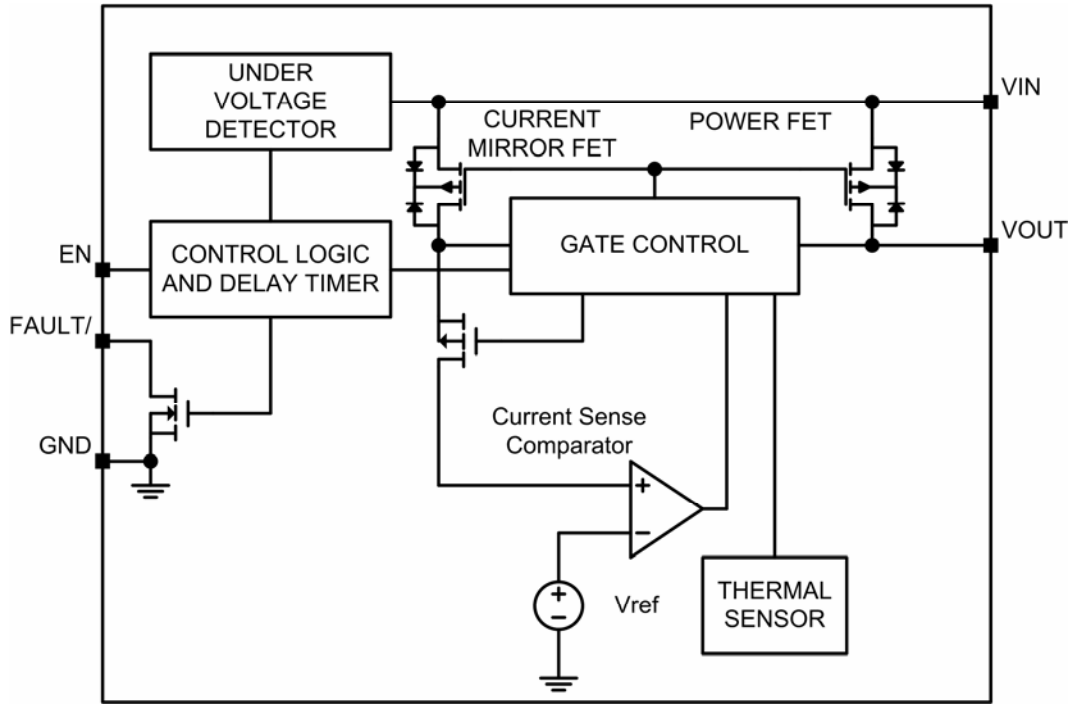

MIC2090/MIC2091 Functional Diagram

## Functional Description

### $V_{IN}$ and $V_{OUT}$

$V_{IN}$  is both the power supply connection for the internal circuitry driving the switch and the input (source connection) of the power MOSFET switch.  $V_{OUT}$  is the drain connection of the power MOSFET and supplies power to the load. In a typical circuit, current flows from  $V_{IN}$  to  $V_{OUT}$  toward the load.

When the switch is disabled, current will not flow to the load, except for a small unavoidable leakage current of a few microamps (forward leakage current).

### $C_{IN}$

A minimum 1 $\mu$ F bypass capacitor positioned close to the  $V_{IN}$  and GND pins of the switch is both good design practice and required for proper operation of the switch. This will control supply transients and ringing. Without a sufficient bypass capacitor, large current surges or a short may cause sufficient ringing on  $V_{IN}$  (from supply lead inductance) to cause erratic operation of the switch's control circuitry. For best performance, place a ceramic capacitor next to the IC.

An additional 10 $\mu$ F (or greater) capacitor, positioned close to the  $V_{IN}$  and GND pins of the switch is necessary if the distance between a larger bulk capacitor and the switch is greater than three inches. This additional capacitor limits input voltage transients at the switch caused by fast changing input currents that occur during a fault condition, such as current limit and thermal shutdown.

When bypassing with capacitors of 10 $\mu$ F or more, it is good practice to place a smaller value capacitor in parallel with the larger to handle the high-frequency components of any line transients. Values in the range of 0.1 $\mu$ F to 1 $\mu$ F are recommended. Again, good quality, low-ESR capacitors, preferably ceramic, should be chosen.

### $C_{OUT}$

An output capacitor is required to reduce ringing and voltage sag on the output during a transient condition. A value between 1 $\mu$ F and 10 $\mu$ F is recommended.

A 10 $\mu$ F or larger capacitor should be used if the distance between the MIC2090/MIC2091 and the load is greater than three inches. The internal switch in the MIC2090/MIC2091 turns off in (typically) 20ns. This extremely fast turn-off can cause an inductive spike in the output voltage when the internal switch turns off during an overcurrent condition. The larger value capacitor prevents the output from glitching too low.

### Limitations on $C_{OUT}$

The part may enter current limit when turning on with a large output capacitance, which is an acceptable condition. However, if the part remains in current limit for a time greater than  $t_{D\_FAULT}$ , the FAULT/ pin will assert low. The maximum value of  $C_{OUT}$  may be approximated by Equation 1:

$$C_{OUT\_MAX} = \frac{I_{LIMIT\_MIN} \times T_{D\_FAULT\_MIN}}{V_{IN\_MAX}} \quad \text{Eq. 1}$$

Where:  $I_{LIMIT\_MIN}$  and  $T_{D\_FAULT\_MIN}$  are the minimum specified values listed in the Electrical Characteristic table and  $V_{IN\_MAX}$  is the maximum input voltage to the switch.

### Current Sensing and Limiting

The MIC2090/MIC2091 protects the system power supply and load from damage by continuously monitoring current through the on-chip power MOSFET. Load current is monitored by means of a current mirror in parallel with the power MOSFET switch. Current limiting is invoked when the load exceeds the overcurrent threshold. When current limiting is activated in the -1 version, the output current is constrained to the limit value, and remains at this level until either the load/fault is removed, the load's current requirement drops below the limiting value, or the switch goes into thermal shutdown. If the overcurrent fault is large enough to drop  $V_{OUT}$  below (typically) 1.8V, the internal MOSFET turns off very quickly (typically 20ns). This prevents excessive current from flowing through the device and damaging the internal MOSFET.

The latch-off feature of the -2 version latches the output off when the output current exceeds the overcurrent threshold.  $V_{IN}$  or the enable pin must be toggled to reset the latch.

### Enable Input

The EN pin is a TTL logic level compatible input which turns the internal MOSFET switch on and off. The FAULT/ pin remains high when the EN pin is pulled low and the output is turned off. Toggling the enable pin resets the output after an OGI (output greater than input) condition occurs. In the -2 version, toggling the enable pin resets the output after an overcurrent event.

### Fault Output

The FAULT/ is an N-channel open-drain output, which is asserted LOW when the MIC2090/MIC2091 switch either begins current limiting or enters thermal shutdown.

During an overcurrent or short circuit, The FAULT/ signal asserts after a brief delay period,  $t_{D\_FAULT/}$ , in order to filter out false or transient over-current conditions.

The FAULT/ output is open-drain and must be pulled HIGH with an external resistor. The FAULT/ signal may be wire-OR'd with other similar outputs, sharing a single pull-up resistor.

**Power Dissipation and Thermal Shutdown**

Thermal shutdown is used to protect the MIC2090/MIC2091 switch from damage should the die temperature exceed a safe operating temperature. Thermal shutdown shuts off the output MOSFET and asserts the FAULT/ output if the die temperature reaches the over-temperature threshold,  $T_{OVERTEMP}$ .

The switch will automatically resume operation when the die temperature cools down to 140°C. If resumed operation results in reheating of the die, another shutdown cycle will occur and the switch will continue cycling between ON and OFF states until the reason for the overcurrent condition has been resolved.

Depending upon the PCB layout, package type, ambient temperature, etc., hundreds of milliseconds may elapse from the time a fault occurs to the time the output MOSFET will be shut off. This delay is caused because of the time it takes for the die to heat after the fault condition occurs.

Power dissipation depends on several factors such as the load, PCB layout, ambient temperature, and supply voltage. Calculation of power dissipation can be accomplished by Equation 2:

$$P_D = R_{DS(ON)} \times (I_{OUT})^2 \quad \text{Eq.2}$$

To relate this to junction temperature, Equation 3 can be used:

$$T_J = P_D \times R_{\theta(J-A)} + T_A \quad \text{Eq. 3}$$

Where:

- $T_J$  = Junction Temperature
- $T_A$  = Ambient Temperature

$R_{\theta(J-A)}$  is the thermal resistance of the package.

In normal operation, excessive switch heating is most often caused by an output short circuit. If the output is shorted, when the switch is enabled, the MIC2090/MIC2091 switch limits the output current to the maximum value. The heat generated by the power dissipation of the switch continuously limiting the current

may exceed the package and PCB's ability to cool the device and the MIC2090/MIC2091 will shut down and signal a fault condition. Please see the "Fault Output" description for more details on the FAULT/ output.

After the MIC2090/MIC2091 shuts down, and cools, it will re-start itself if the enable signal remains true.

In Figure 2, die temperature is plotted against  $I_{OUT}$  assuming a constant ambient temperature of 85°C and a worst case internal switch on-resistance ( $R_{ON}$ ). This plot is valid for both the MIC2090 and MIC2091.

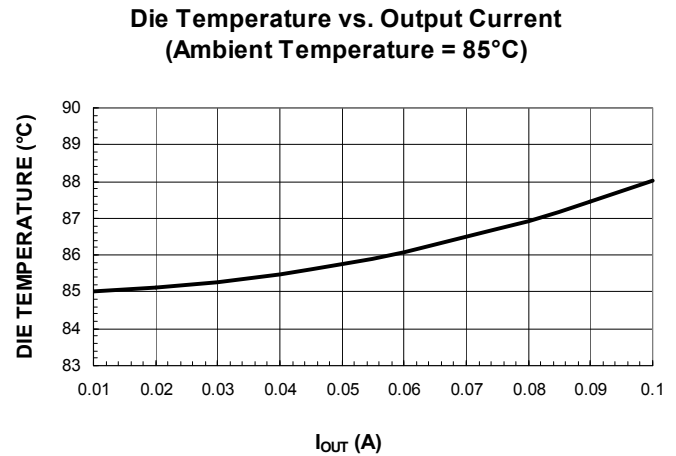

**Figure 2. Die Temperature vs.  $I_{OUT}$**

**$I_{LIMIT}$  vs.  $I_{OUT}$  Measured (-1 version only)**

When the MIC2090/MIC2091 is current limiting, it is designed to act as a constant current source to the load. As the load tries to pull more than the maximum current,  $V_{OUT}$  drops and the input to output voltage differential increases. When  $V_{OUT}$  drops below 1.8V, then the output switch momentarily turns off to insure the internal MOSFET switch is not damaged by a very fast short circuit event.

When measuring  $I_{OUT}$  in an overcurrent condition, it is important to remember voltage dependence, otherwise the measurement data may appear to indicate a problem when none really exists. This voltage dependence is illustrated in Figures 3 and 4.

In Figure 3, output current is measured as  $V_{OUT}$  is pulled below  $V_{IN}$ , with the test terminating when  $V_{OUT}$  is 2.5V below  $V_{IN}$ . Observe that once  $I_{LIMIT}$  is reached  $I_{OUT}$  remains constant throughout the remainder of the test.

Figure 4 repeats this test but simulates operation deeper into an overcurrent condition. When  $V_{OUT}$  drops below 1.8V, the switch turns off for a few microseconds before turning back on.



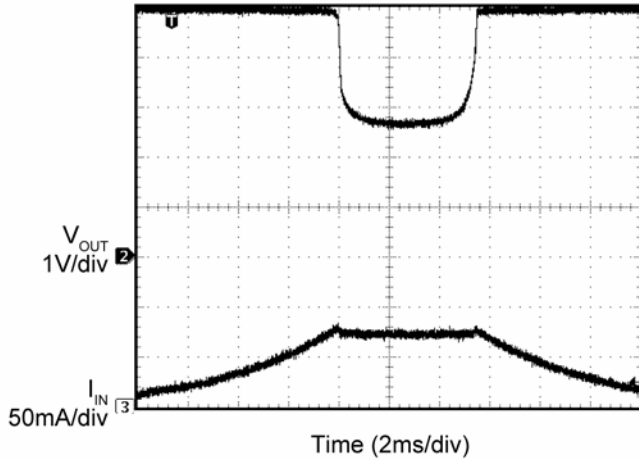

Figure 3.  $I_{OUT}$  in Current Limiting for  $V_{OUT} > 1.8V$

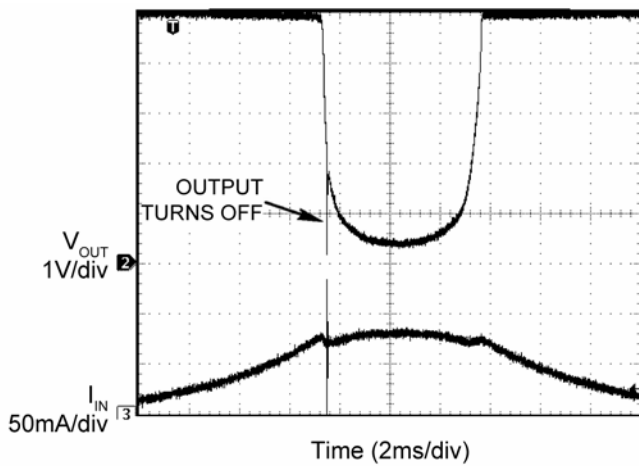

Figure 4.  $I_{OUT}$  in Current Limiting for  $V_{OUT} < 1.8V$

**Under-Voltage Lock Out (UVLO)**

The MIC2090/MIC2091 switches have an Under-Voltage Lock Out (UVLO) feature that will shut down the switch in a reproducible way when the input power supply voltage goes too low. The UVLO circuit disables the output until the supply voltage exceeds the UVLO threshold. Hysteresis in the UVLO circuit prevents noise and finite circuit impedance from causing chatter during turn-on and turn-off. While disabled by the UVLO circuit, the output switch (power MOSFET) is OFF and no circuit functions, such as FAULT/ or EN, are considered to be valid or operative.

**OGI (Output Greater than Input)**

The internal MOSFET switch turns off when it senses an output voltage that is greater than the input voltage. This feature prevents continuous current from flowing from the output to the input.

If the output voltage rises above  $V_{IN}$  by the OGI threshold voltage (typically 85mV), the internal MOSFET switch turns off after a period of time, specified in the electrical characteristics table as  $OGI_{TIME}$ . The FAULT/ pin remains high during and after an OGI event.

Figure 5 shows the output voltage, input current and FAULT/ pin voltage when the output voltage is raised above the input. Reverse current flows through the internal MOSFET switch for the  $OGI_{TIME}$  period, until the internal MOSFET switch is turned off and the input current goes to 0A.

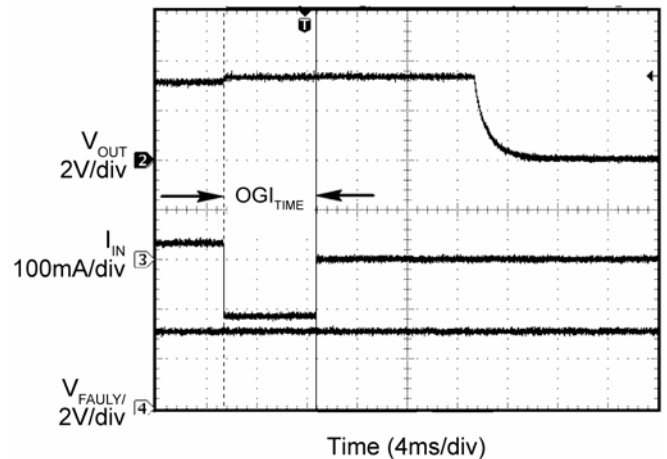
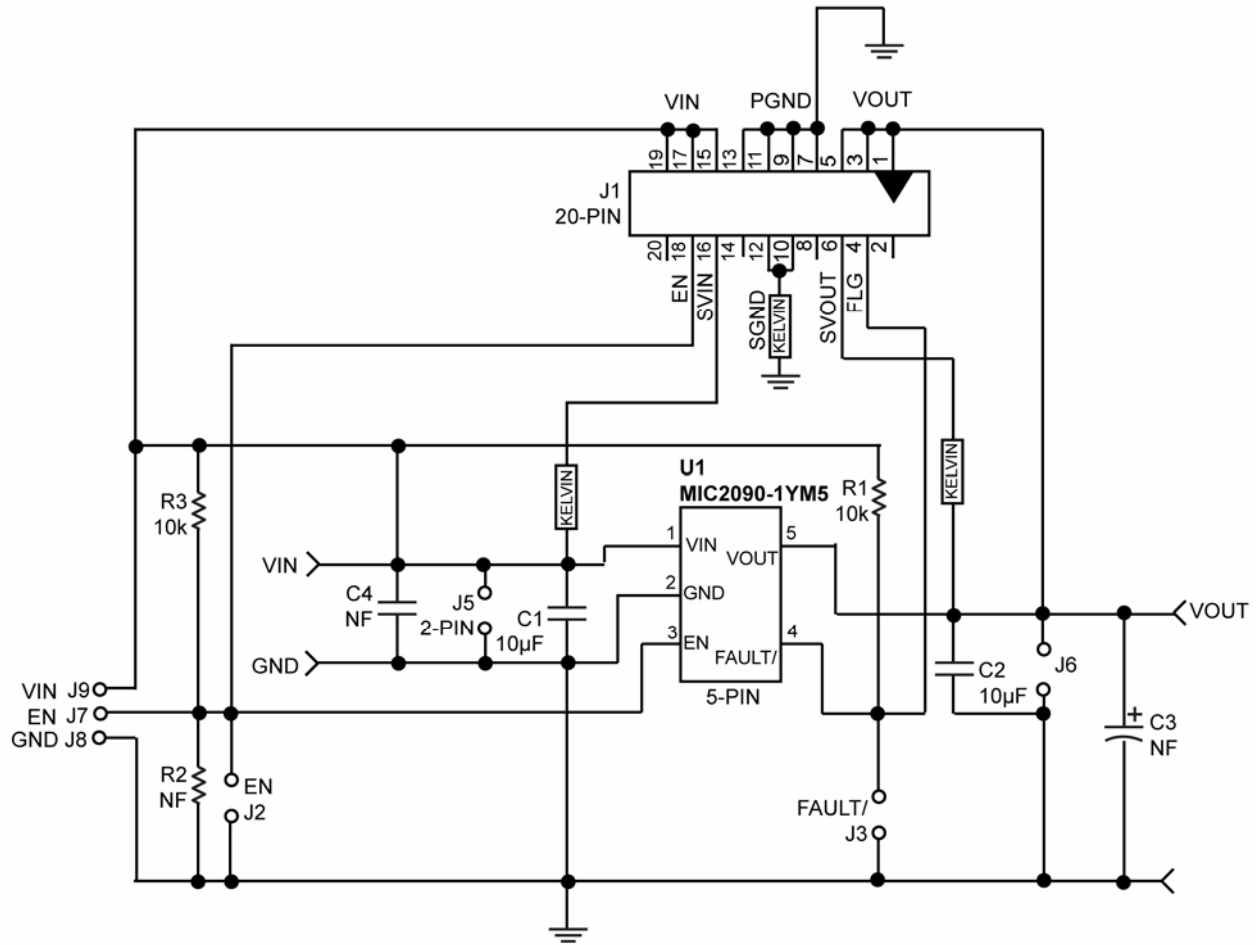

Figure 5. OGI Event

### MIC2090/MIC2091 Evaluation Board Schematic



**Bill of Materials**

Item	Part Number	Manufacturer	Description	Qty.
C1, C2	08056D106MAT2A	AVX <sup>(1)</sup>	10 $\mu$ F, 6.3V Ceramic Capacitor, X5R	2
C3, C4			NF (No Fill)	2
R1, R3	CRCW06031002FRT1	Vishay Dale <sup>(2)</sup>	10k, 1%, 0603 Resistor	2
R2			NF (No Fill)	1
<b>U1</b>	<b>MIC2090-1YM5</b>	<b>Micrel, Inc.<sup>(3)</sup></b>	<b>Current Limiting Power Distribution Switch</b>	<b>1</b>
<b>U1</b>	<b>MIC2091-1YM5</b>	<b>Micrel, Inc.<sup>(3)</sup></b>	<b>Current Limiting Power Distribution Switch</b>	<b>0</b>
<b>U1</b>	<b>MIC2090-2YM5</b>	<b>Micrel, Inc.<sup>(3)</sup></b>	<b>Current Limiting Power Distribution Switch</b>	<b>0</b>
<b>U1</b>	<b>MIC2091-2YM5</b>	<b>Micrel, Inc.<sup>(3)</sup></b>	<b>Current Limiting Power Distribution Switch</b>	<b>0</b>

**Notes:**

1. AVX: [www.avx.com](http://www.avx.com).
2. Vishay Tel: [www.vishay.com](http://www.vishay.com).
3. Micrel, Inc.: [www.micrel.com](http://www.micrel.com).

### PCB Layout Recommendations

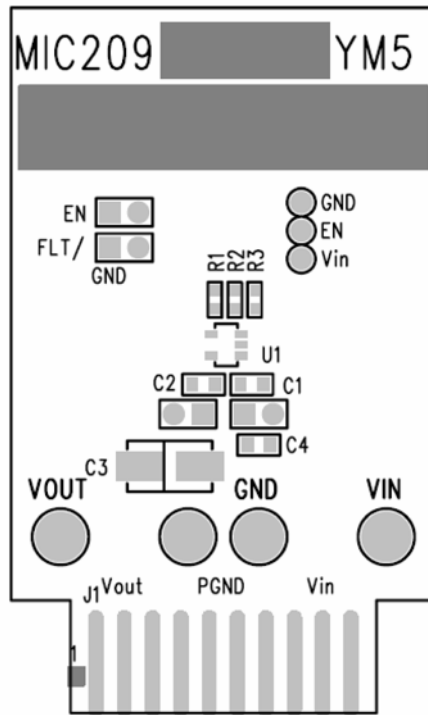

Top Silk Screen

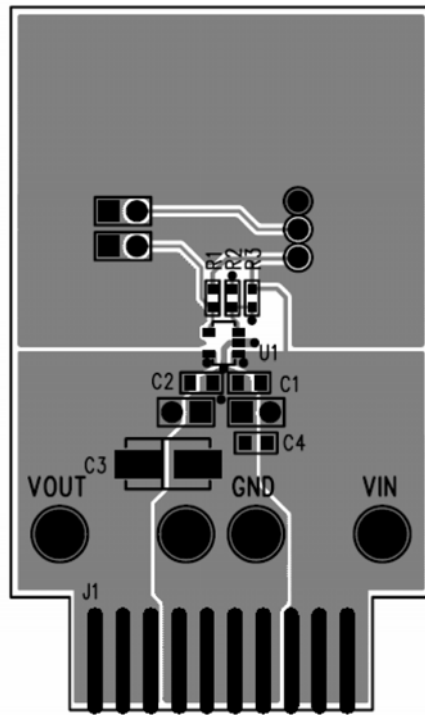

Top Copper

### PCB Layout Recommendations (Continued)

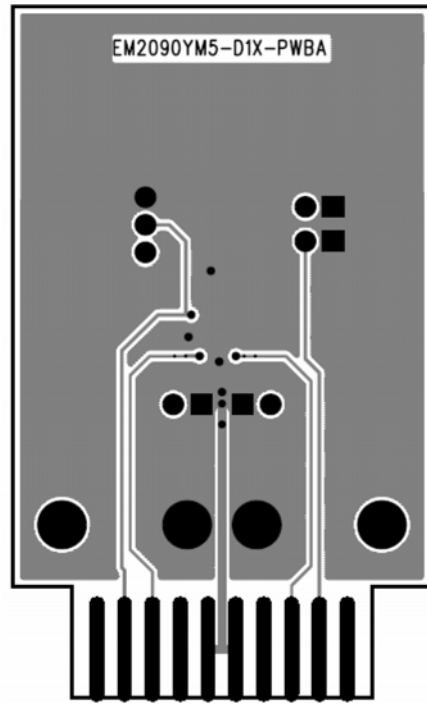

Bottom Copper

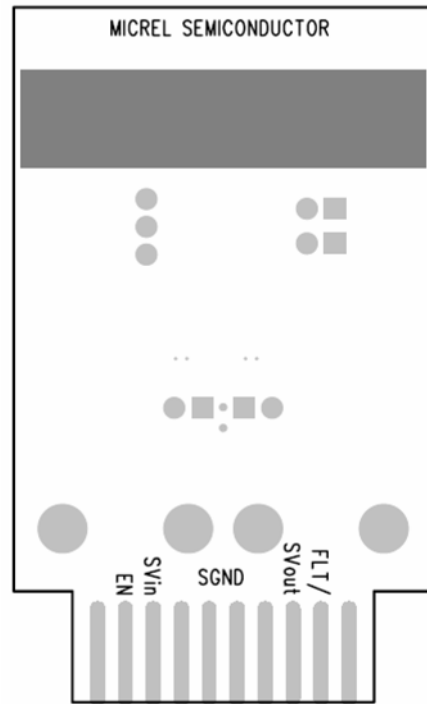

Bottom Silk Screen

### Package Information

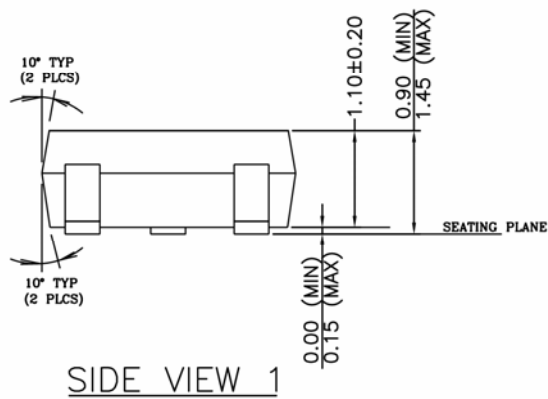
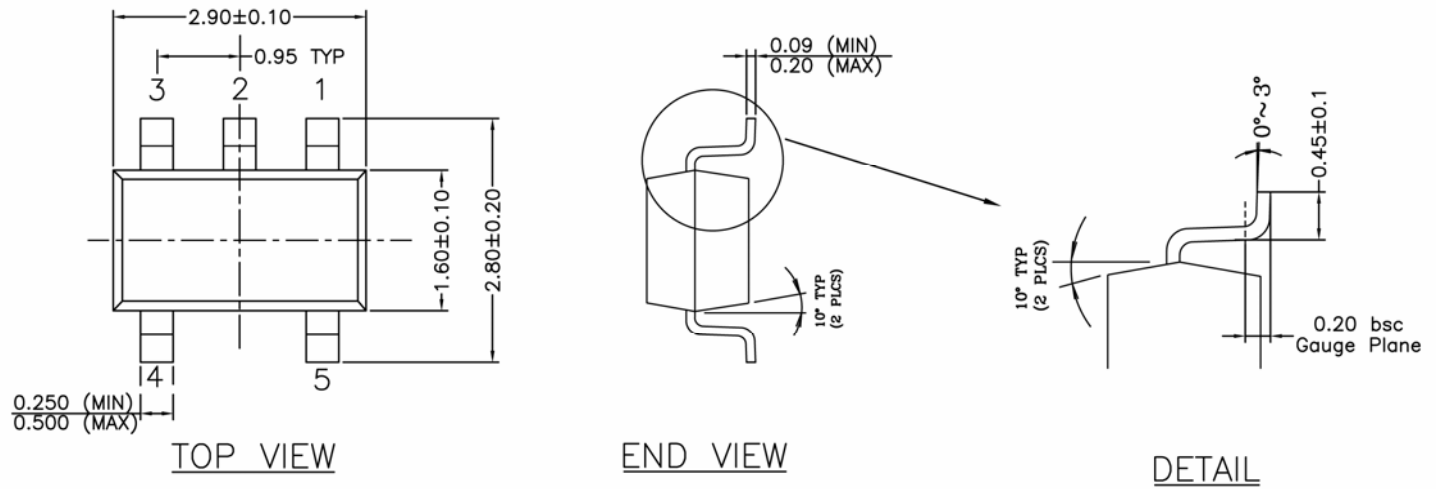

**NOTE:**

1. PACKAGE OUTLINE EXCLUSIVE OF MOLD FLASH & BURR.
2. PACKAGE OUTLINE INCLUSIVE OF SOLER PLATING.
3. DIMENSION AND TOLERANCE PER ANSI Y14.5M, 1982.
4. FOOT LENGTH MEASUREMENT BASED ON GAUGE PLANE METHOD.
5. DIE FACES UP FOR MOLD, AND FACES DOWN FOR TRIM/FORM.
6. ALL DIMENSIONS ARE IN MILLIMETERS.

**5-Pin SOT23 (SOT23-5)**

## Recommended Landing Pattern

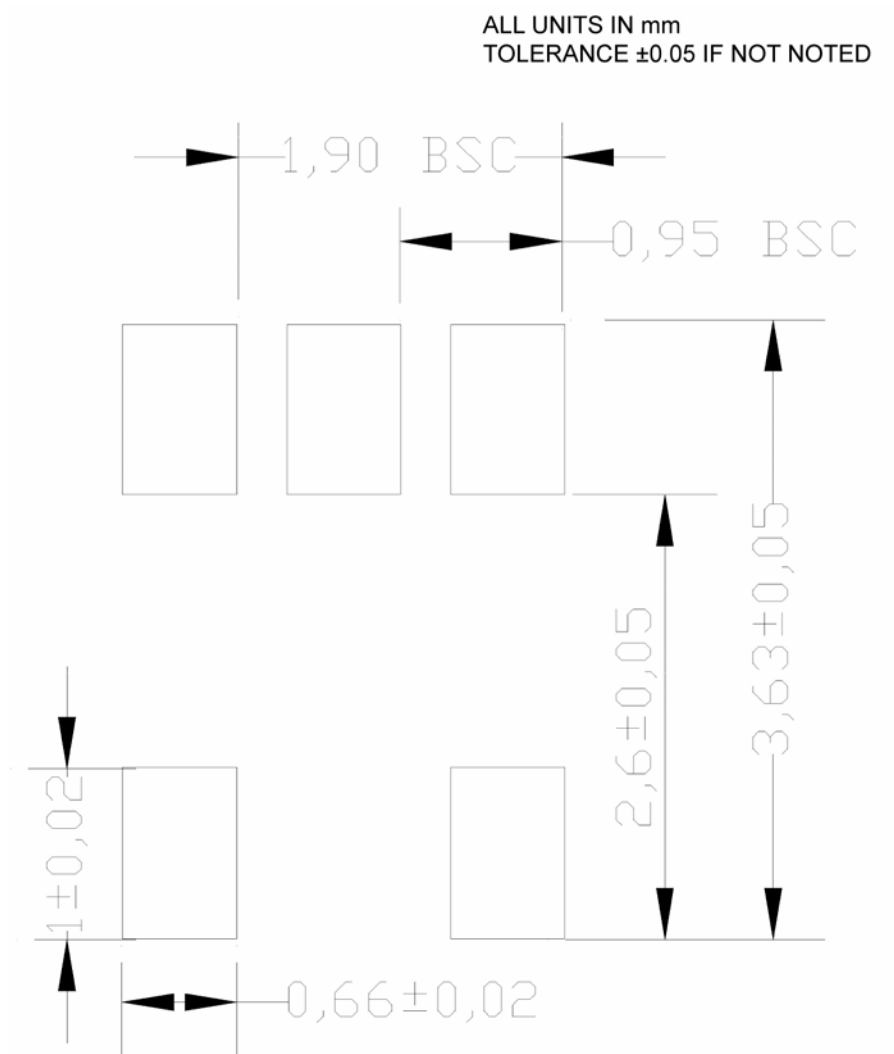

**MICREL, INC. 2180 FORTUNE DRIVE SAN JOSE, CA 95131 USA**  
 TEL +1 (408) 944-0800 FAX +1 (408) 474-1000 WEB <http://www.micrel.com>

Micrel makes no representations or warranties with respect to the accuracy or completeness of the information furnished in this data sheet. This information is not intended as a warranty and Micrel does not assume responsibility for its use. Micrel reserves the right to change circuitry, specifications and descriptions at any time without notice. No license, whether express, implied, arising by estoppel or otherwise, to any intellectual property rights is granted by this document. Except as provided in Micrel's terms and conditions of sale for such products, Micrel assumes no liability whatsoever, and Micrel disclaims any express or implied warranty relating to the sale and/or use of Micrel products including liability or warranties relating to fitness for a particular purpose, merchantability, or infringement of any patent, copyright or other intellectual property right.

Micrel Products are not designed or authorized for use as components in life support appliances, devices or systems where malfunction of a product can reasonably be expected to result in personal injury. Life support devices or systems are devices or systems that (a) are intended for surgical implant into the body or (b) support or sustain life, and whose failure to perform can be reasonably expected to result in a significant injury to the user. A Purchaser's use or sale of Micrel Products for use in life support appliances, devices or systems is a Purchaser's own risk and Purchaser agrees to fully indemnify Micrel for any damages resulting from such use or sale.

© 2011 Micrel, Incorporated.

# Mouser Electronics

Authorized Distributor

Click to View Pricing, Inventory, Delivery & Lifecycle Information:

## Micrel:

[MIC2091-1YM5 TR](#) [MIC2090-1YM5 TR](#)

## Microchip:

[MIC2090-2YM5-TR](#) [MIC2090-1YM5-TR](#) [MIC2091-1YM5-TR](#) [MIC2091-2YM5-TR](#)





## Стандарт Электрон Связь

Мы молодая и активно развивающаяся компания в области поставок электронных компонентов. Мы поставляем электронные компоненты отечественного и импортного производства напрямую от производителей и с крупнейших складов мира.

Благодаря сотрудничеству с мировыми поставщиками мы осуществляем комплексные и плановые поставки широчайшего спектра электронных компонентов.

Собственная эффективная логистика и склад в обеспечивает надежную поставку продукции в точно указанные сроки по всей России.

Мы осуществляем техническую поддержку нашим клиентам и предпродажную проверку качества продукции. На все поставляемые продукты мы предоставляем гарантию .

Осуществляем поставки продукции под контролем ВП МО РФ на предприятия военно-промышленного комплекса России , а также работаем в рамках 275 ФЗ с открытием отдельных счетов в уполномоченном банке. Система менеджмента качества компании соответствует требованиям ГОСТ ISO 9001.

Минимальные сроки поставки, гибкие цены, неограниченный ассортимент и индивидуальный подход к клиентам являются основой для выстраивания долгосрочного и эффективного сотрудничества с предприятиями радиоэлектронной промышленности, предприятиями ВПК и научно-исследовательскими институтами России.

С нами вы становитесь еще успешнее!

### Наши контакты:

**Телефон:** +7 812 627 14 35

**Электронная почта:** [sales@st-electron.ru](mailto:sales@st-electron.ru)

**Адрес:** 198099, Санкт-Петербург,  
Промышленная ул, дом № 19, литера Н,  
помещение 100-Н Офис 331